

FLOODMAX FM SERIES



FMS 20/30W



FMM 50/80W



FML 120W



FMX 200/310W



PRODUCT DESCRIPTION:

The FloodMax family of fixtures combines performance and design in a value package. It is available in 4 sizes and 7 wattages ranging from 20W-310W. The smaller sizes come with 1/2" threaded adjustable knuckle slipfitter or a trunnion. The larger sizes come with either a 2 3/8" adjustable knuckle slipfitter or a trunnion. Typical applications include general area lighting, facade, landscape as well as signage.

FEATURES:

- 2,500 to 40,000 lumens
- 120-277V 0-10V driver, 347-480V option (50W+ versions)
- Wide distribution standard (NEMA 6x6 or 7x7); Narrow distribution (NEMA 3x3) option
- CRI: >70
- Photo control (2 fixtures in one):
 - 120-277V button PC with removable cap included on 20-80W
 - NEMA twist lock receptacle with removable shorting cap included on 120-310W
- 10KV surge protection standard

CONSTRUCTION:

- Die cast aluminum housing with integrated heat sinking to maximize performance and fixture life
- Polyester powder coat finish provides corrosion resistance
- Passes IK08 impact test (FMS requires vandal shield accessory)

WARRANTY:

10-year standard warranty with labor allowance* (further details available at www.maxlite.com/warranties)

*Warranty Limitations: Product must be rated for the application per the Product Data Sheet (PDS); operated ≤16 hrs/day; in ambient of -29°F to 104°F.

*Up to \$25/unit; labor allowances of up to \$500/unit available for purchase – contact MaxLite representative for details.

| MODEL SELECTION | | Typical order example: FML120UW-40BSKRPC | | | | | | |
|--------------------------------------|--|--|------------------------------------|---|--------------------------------------|---|--|--|
| FAMILY | NOMINAL WATTAGE | VOLTAGE | DISTRIBUTION | - | CCT | COLOR | MOUNTING | CONTROLS |
| FMS= FloodMax Small (20/30W) | 20= 20W 30= 30W 50= 50W | U= Universal 120-277V H'= 347-480V (50W+) | N= Narrow W= Wide | | 40= 4000K 50= 5000K | B= Bronze | KT= Knuckle with 1/2" thread (20/30/50/80W) | Included Standard with 20/30/50/80W PC= 120V-277V button photo-cell with removable cap |
| FMM= FloodMax Medium (50/80W) | 80= 80W 120= 120W 200= 200W 310= 310W | | | | | <i>Contact Maxlite for additional finishes.</i> | SK= Slipfitter Knuckle (50/80/120/200/310W) | Included standard with 120/200/310W RPC= 3-pin NEMA twist lock receptacle with shorting cap |
| FML= FloodMax Large (120W) | | | | | | | TS= Trunnion Swivel (All versions) | Option for 120/200/310W PR7= 7-pin NEMA twist lock receptacle |
| FMX= FloodMax XL (200/310W) | | | | | | | | Option for FMX 200/310W MS= Daylight/Motion Sensor |

1. Photocontrol not available for 50/80W in 480V.

SPECIFICATIONS:





DETAILS

| ITEM | SPECIFICATION | 20W | 30W | 50W | 80W | 120W | 200W | 310W | |
|----------------------------|--------------------------------------|---|--------------|---|-----------------------------|------------------------|----------------------|-----------------|--|
| GENERAL PERFORMANCE | Output (lm) | 2,300-2,500 | 3,400-3,700 | 6,900-7,400 | 9,900-10,600 | 14,350-15,300 | 29,590-31,100 | 39,600-41,600 | |
| | Efficacy (lm/W) | 119 | 115 | 131 | 133 | 130 | 135 | 129 | |
| | Beam Spread Narrow (NEMA/Beam Angle) | 3x3/20.8°-20.3° | | | | | | 3x3/19.9°-20.2° | |
| | Beam Spread Wide (NEMA/Field Angle) | 7x7/137°-148° | | 6x6/128°-125° | 6x6/128°-128° | 6x6/126°-124° | 6x6/129°-124° | 6x6/125°-130° | |
| | Max Candela (Narrow/Wide) | 13,416/931 | 19,706/1,384 | 39,809/3,173 | 57,127/4,415 | 82,406/7,109 | 156,782/14,118 | 209,882/21,247 | |
| | Color Temperature (CCT) | 4000K or 5000K | | | | | | | |
| | CRI | >70 | | | | | | | |
| | Lumen Maintenance (L90) hrs | >100,000 | | | | | | | |
| ELECTRICAL | Wattage (W) | 19.5 | 29.5 | 52.7 | 74.4 | 110.5 | 218 | 307 | |
| | Power Factor | >0.90 | | | | | | | |
| | Input Voltage | 120-277V; 347-480V option | | | | | | | |
| PHYSICAL | Housing | Die Cast Aluminum | | | | | | | |
| | Lens | Tempered Glass | | | UV stabilized Polycarbonate | | | | |
| | Weight | 10.5pds/4.7kg | | 11.5pds/5.2kg | | 16.9pds/7.7kg | 19.3pds/8.75kg | | |
| | Mounting | 1/2" Threaded Knuckle or Yoke | | 1/2" Threaded knuckle, Slipfitter or Trunnion | | Slipfitter or Trunnion | | | |
| | EPA | 0.25 | | 0.68 | | 0.97 | 1.53 | | |
| | Operating Temperature | -22F/-30C - 104F/40C | | | | | -40F/-40C - 104F/40C | | |
| QUALIFICATION | Certification | DLC Premium, cUL, FCC, IK08 (FMS requires vandal shield), 1.5G ANSI vibration rated | | | | | | | |
| | Environment | Wet locations and IP65 | | | | | | | |
| | Warranty | 10-year standard warranty* | | | | | | | |

ORDERING:

| ORDER CODE | MODEL | WATTAGE | EQUIVALENT | LUMENS | NEMA DISTRIBUTION (H X V) | MOUNTING | CCT |
|------------|-------------------|---------|------------|---------------|---------------------------|-----------------------|-------|
| 14100143 | FMS20UW-40BKTPC | 20W | 50W HID | 2,300-2,500 | 7X7 | 1/2" threaded knuckle | 4000K |
| 14100144 | FMS20UW-50BKTPC | 20W | 50W HID | 2,300-2,500 | 7X7 | 1/2" threaded knuckle | 5000K |
| 14100145 | FMS30UW-40BKTPC | 30W | 100W HID | 3,400-3,700 | 7X7 | 1/2" threaded knuckle | 4000K |
| 14100146 | FMS30UW-50BKTPC | 30W | 100W HID | 3,400-3,700 | 7X7 | 1/2" threaded knuckle | 5000K |
| 14100147 | FMM50UW-40BKTPC | 50W | 150W HID | 6,900-7,400 | 6x6 | 1/2" threaded knuckle | 4000K |
| 14100148 | FMM50UW-50BKTPC | 50W | 150W HID | 6,900-7,400 | 6x6 | 1/2" threaded knuckle | 5000K |
| 14100149 | FMM80UW-40BKTPC | 80W | 250W HID | 9,900-10,600 | 6x6 | 1/2" threaded knuckle | 4000K |
| 14100150 | FMM80UW-50BKTPC | 80W | 250W HID | 9,900-10,600 | 6x6 | 1/2" threaded knuckle | 5000K |
| 14100155 | FML120UW-40BSKRPC | 120W | 400W HID | 14,350,15,300 | 6x6 | Slipfitter Knuckle | 4000K |
| 14100157 | FML120UW-40BTSRPC | 120W | 400W HID | 14,350,15,300 | 6x6 | Trunnion | 4000K |
| 14100156 | FML120UW-50BSKRPC | 120W | 400W HID | 14,350,15,300 | 6x6 | Slipfitter Knuckle | 5000K |
| 14100158 | FML120UW-50BTSRPC | 120W | 400W HID | 14,350,15,300 | 6x6 | Trunnion | 5000K |
| 14100159 | FMX200UW-40BSKRPC | 200W | 750W HID | 29,590-31,100 | 6x6 | Slipfitter Knuckle | 4000K |
| 14100161 | FMX200UW-40BTSRPC | 200W | 750W HID | 29,590-31,100 | 6x6 | Trunnion | 4000K |
| 14100160 | FMX200UW-50BSKRPC | 200W | 750W HID | 29,590-31,100 | 6x6 | Slipfitter Knuckle | 5000K |
| 14100162 | FMX200UW-50BTSRPC | 200W | 750W HID | 29,590-31,100 | 6x6 | Trunnion | 5000K |
| 14100163 | FMX310UW-40BSKRPC | 310W | 1,000W HID | 39,600-41,600 | 6x6 | Slipfitter Knuckle | 4000K |
| 14100165 | FMX310UW-40BSKRPC | 310W | 1,000W HID | 39,600-41,600 | 6x6 | Trunnion | 4000K |
| 14100164 | FMX310UW-50BSKRPC | 310W | 1,000W HID | 39,600-41,600 | 6x6 | Slipfitter Knuckle | 5000K |
| 14100166 | FMX310UW-50BTSRPC | 310W | 1,000W HID | 39,600-41,600 | 6x6 | Trunnion | 5000K |

ACCESSORIES

| ITEM ACCESSORY | ITEM NAME | DESCRIPTION | ITEM IMAGE |
|----------------|-------------|---|---|
| VISORS | FMS-VISOR-B | Top or Bottom Visor (order 2 for full visor) |  |
| | FMM-VISOR-B | Top or Bottom Visor (order 2 for full visor) | |
| | FML-VISOR-B | Top or Bottom Visor (order 2 for full visor) | |
| | FMX-VISOR-B | Top or Bottom Visor (order 2 for full visor) | |
| Photocontrols | 6390LBK | Twist-Lock Electronic Photocontrol 120/208/240/277V- FML/FMX Only |  |
| | 6394LL | Twist-Lock Electronic Photocontrol 432-528VAC- FML/FMX Only |  |
| Tennon Reducer | 101679 | Tennon Reducer, 2-3/8" to 1/2", Bronze |  |
| Vandal Shield | FMS-VANDAL | Vandal shield (IK08) for FMS series | |

LINE DRAWINGS:

20W 30W with 1/2" THREAD KNUCKLE MOUNT



20W 30W with Trunnion Swivel



50W 80W with 1/2" THREAD KNUCKLE MOUNT



50W 80W with TRUNNION SWIVEL MOUNT

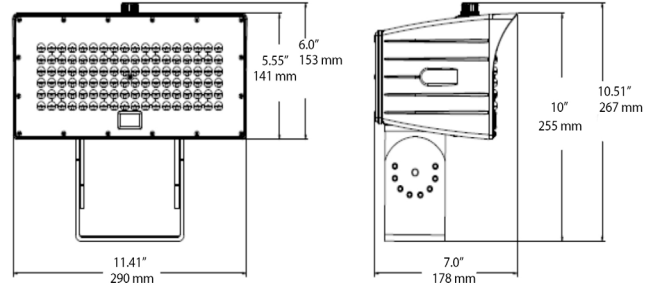

120W with Slip fitter Knuckle



50W 80W with Slip Fitter Knuckle

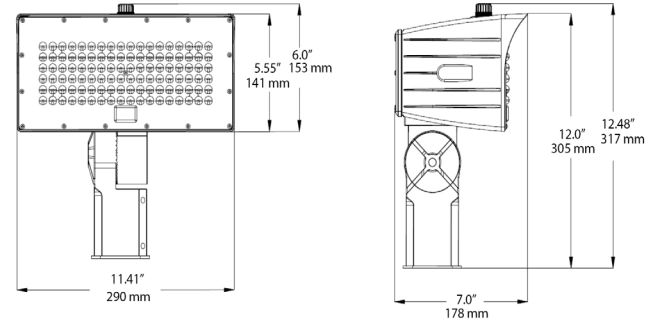

120W with TRUNNION SWIVEL MOUNT



200W 310W with TRUNNION SWIVEL MOUNT



200W 310W with Slip fitter Knuckle

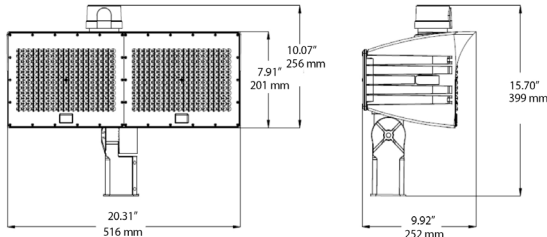

MOUNTING DIMENSIONS:



Slipfitter Knuckle (50/80/120/200/310W)



Knuckle 1/2" Thread (20/30W)

Trunion Swivel
(50/80/120/200/310W)



DIMENSIONS:

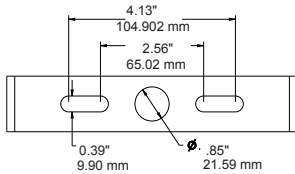
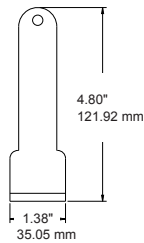
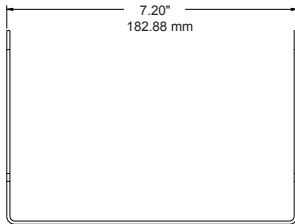

Trunion Swivel (FMS 20/30W)



Knuckle 1/2" Thread (FMM 50/80W)

ISOFOOTCANDLE:

Each gridline represents one mounting height.
 For mounting heights other than noted multiply FC by the below factor.
 Factor = $\frac{(\text{Chart's Mtg Height})^2}{(\text{Actual Mtg Height})^2}$

LEGEND

- | | |
|--|--|
| 0.5 fc | 10 fc |
| 1 fc | 20 fc |
| 2 fc | 50 fc |
| 5 fc | |

NARROW

WIDE

20 WATT
15' ft Set back

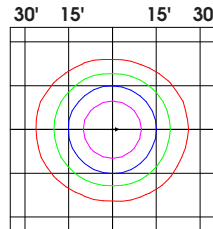

50 WATT
20' ft Set back

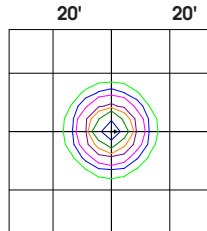

120 WATT
30' ft Set back

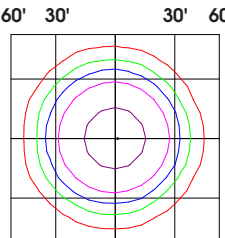
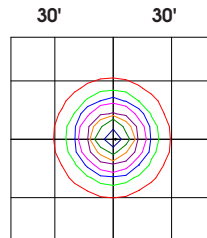

310 WATT
50' ft Set back

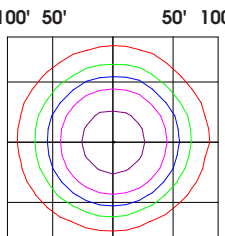
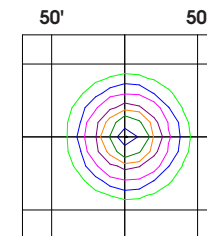

NARROW

WIDE

30 WATT
18' ft Set back



80 WATT
25' ft Set back



200 WATT
40' ft Set back

