

## FLOODMAX FM SERIES



FMS 20/30W



FMM 50/80W



FML 120W

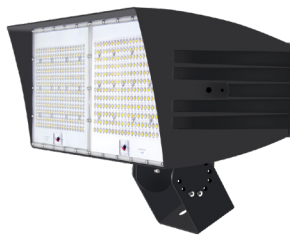

FMX 200/310W



### PRODUCT DESCRIPTION:

The FloodMax family of fixtures combines performance and design in a value package. It is available in 4 sizes and 7 wattages ranging from 20W-310W. The smaller sizes come with 1/2" threaded adjustable knuckle slipfitter or a trunnion. The larger sizes come with either a 2 3/8" adjustable knuckle slipfitter or a trunnion. Typical applications include general area lighting, facade, landscape as well as signage.

### FEATURES:

- 2,500 to 40,000 lumens
- 120-277V 0-10V driver, 347-480V option (50W+ versions)
- Wide distribution standard (NEMA 6x6 or 7x7); Narrow distribution (NEMA 3x3) option
- CRI: >70
- Photo control (2 fixtures in one):
  - 120-277V button PC with removable cap included on 20-80W
  - NEMA twist lock receptacle with removable shorting cap included on 120-310W
- 10KV surge protection standard

### CONSTRUCTION:

- Die cast aluminum housing with integrated heat sinking to maximize performance and fixture life
- Polyester powder coat finish provides corrosion resistance
- Passes IK08 impact test (FMS requires vandal shield accessory)

### WARRANTY:

10-year standard warranty with labor allowance\* (further details available at [www.maxlite.com/warranties](http://www.maxlite.com/warranties))

\*Warranty Limitations: Product must be rated for the application per the Product Data Sheet (PDS); operated ≤16 hrs/day; in ambient of -29°F to 104°F.

\*Up to \$25/unit; labor allowances of up to \$500/unit available for purchase – contact MaxLite representative for details.

MODEL SELECTION		Typical order example: FML120UW-40BSKRPC						
FAMILY	NOMINAL WATTAGE	VOLTAGE	DISTRIBUTION	-	CCT	COLOR	MOUNTING	CONTROLS
<b>FMS=</b> FloodMax Small (20/30W)	<b>20=</b> 20W <b>30=</b> 30W <b>50=</b> 50W	<b>U=</b> Universal 120-277V <b>H'=</b> 347-480V (50W+)	<b>N=</b> Narrow <b>W=</b> Wide		<b>40=</b> 4000K <b>50=</b> 5000K	<b>B=</b> Bronze	<b>KT=</b> Knuckle with 1/2" thread (20/30/50/80W)	<b>Included Standard with 20/30/50/80W PC=</b> 120V-277V button photo-cell with removable cap
<b>FMM=</b> FloodMax Medium (50/80W)	<b>80=</b> 80W <b>120=</b> 120W <b>200=</b> 200W <b>310=</b> 310W					<i>Contact Maxlite for additional finishes.</i>	<b>SK=</b> Slipfitter Knuckle (50/80/120/200/310W)	<b>Included standard with 120/200/310W RPC=</b> 3-pin NEMA twist lock receptacle with shorting cap
<b>FML=</b> FloodMax Large (120W)							<b>TS=</b> Trunnion Swivel (All versions)	<b>Option for 120/200/310W PR7=</b> 7-pin NEMA twist lock receptacle
<b>FMX=</b> FloodMax XL (200/310W)								<b>Option for FMX 200/310W MS=</b> Daylight/Motion Sensor

1. Photocontrol not available for 50/80W in 480V.

**SPECIFICATIONS:**





**DETAILS**

ITEM	SPECIFICATION	20W	30W	50W	80W	120W	200W	310W	
<b>GENERAL PERFORMANCE</b>	Output (lm)	2,300-2,500	3,400-3,700	6,900-7,400	9,900-10,600	14,350-15,300	29,590-31,100	39,600-41,600	
	Efficacy (lm/W)	119	115	131	133	130	135	129	
	Beam Spread Narrow (NEMA/Beam Angle)	3x3/20.8°-20.3°						3x3/19.9°-20.2°	
	Beam Spread Wide (NEMA/Field Angle)	7x7/137°-148°			6x6/128°-125°	6x6/128°-128°	6x6/126°-124°	6x6/129°-124°	6x6/125°-130°
	Max Candela (Narrow/Wide)	13,416/931	19,706/1,384	39,809/3,173	57,127/4,415	82,406/7,109	156,782/14,118	209,882/21,247	
	Color Temperature (CCT)	4000K or 5000K							
	CRI	>70							
	Lumen Maintenance (L90) hrs	>100,000							
<b>ELECTRICAL</b>	Wattage (W)	19.5	29.5	52.7	74.4	110.5	218	307	
	Power Factor	>0.90							
	Input Voltage	120-277V; 347-480V option							
<b>PHYSICAL</b>	Housing	Die Cast Aluminum							
	Lens	Tempered Glass			UV stabilized Polycarbonate				
	Weight	10.5pds/4.7kg			11.5pds/5.2kg		16.9pds/7.7kg	19.3pds/8.75kg	
	Mounting	1/2" Threaded Knuckle or Yoke			1/2" Threaded knuckle, Slipfitter or Trunnion		Slipfitter or Trunnion		
	EPA	0.25			0.68		0.97	1.53	
	Operating Temperature	-22F/-30C - 104F/40C					-40F/-40C - 104F/40C		
<b>QUALIFICATION</b>	Certification	DLC Premium, cUL, FCC, IK08 (FMS requires vandal shield), 1.5G ANSI vibration rated							
	Environment	Wet locations and IP65							
	Warranty	10-year standard warranty*							

**ORDERING:**

ORDER CODE	MODEL	WATTAGE	EQUIVALENT	LUMENS	NEMA DISTRIBUTION (H X V)	MOUNTING	CCT
14100143	FMS20UW-40BKTPC	20W	50W HID	2,300-2,500	7X7	1/2" threaded knuckle	4000K
14100144	FMS20UW-50BKTPC	20W	50W HID	2,300-2,500	7X7	1/2" threaded knuckle	5000K
14100145	FMS30UW-40BKTPC	30W	100W HID	3,400-3,700	7X7	1/2" threaded knuckle	4000K
14100146	FMS30UW-50BKTPC	30W	100W HID	3,400-3,700	7X7	1/2" threaded knuckle	5000K
14100147	FMM50UW-40BKTPC	50W	150W HID	6,900-7,400	6x6	1/2" threaded knuckle	4000K
14100148	FMM50UW-50BKTPC	50W	150W HID	6,900-7,400	6x6	1/2" threaded knuckle	5000K
14100149	FMM80UW-40BKTPC	80W	250W HID	9,900-10,600	6x6	1/2" threaded knuckle	4000K
14100150	FMM80UW-50BKTPC	80W	250W HID	9,900-10,600	6x6	1/2" threaded knuckle	5000K
14100155	FML120UW-40BSKRPC	120W	400W HID	14,350,15,300	6x6	Slipfitter Knuckle	4000K
14100157	FML120UW-40BTSRPC	120W	400W HID	14,350,15,300	6x6	Trunnion	4000K
14100156	FML120UW-50BSKRPC	120W	400W HID	14,350,15,300	6x6	Slipfitter Knuckle	5000K
14100158	FML120UW-50BTSRPC	120W	400W HID	14,350,15,300	6x6	Trunnion	5000K
14100159	FMX200UW-40BSKRPC	200W	750W HID	29,590-31,100	6x6	Slipfitter Knuckle	4000K
14100161	FMX200UW-40BTSRPC	200W	750W HID	29,590-31,100	6x6	Trunnion	4000K
14100160	FMX200UW-50BSKRPC	200W	750W HID	29,590-31,100	6x6	Slipfitter Knuckle	5000K
14100162	FMX200UW-50BTSRPC	200W	750W HID	29,590-31,100	6x6	Trunnion	5000K
14100163	FMX310UW-40BSKRPC	310W	1,000W HID	39,600-41,600	6x6	Slipfitter Knuckle	4000K
14100165	FMX310UW-40BSKRPC	310W	1,000W HID	39,600-41,600	6x6	Trunnion	4000K
14100164	FMX310UW-50BSKRPC	310W	1,000W HID	39,600-41,600	6x6	Slipfitter Knuckle	5000K
14100166	FMX310UW-50BTSRPC	310W	1,000W HID	39,600-41,600	6x6	Trunnion	5000K

**ACCESSORIES**

ITEM ACCESSORY	ITEM NAME	DESCRIPTION	ITEM IMAGE
VISORS	FMS-VISOR-B	Top or Bottom Visor (order 2 for full visor)	
	FMM-VISOR-B	Top or Bottom Visor (order 2 for full visor)	
	FML-VISOR-B	Top or Bottom Visor (order 2 for full visor)	
	FMX-VISOR-B	Top or Bottom Visor (order 2 for full visor)	
Photocontrols	6390LBK	Twist-Lock Electronic Photocontrol 120/208/240/277V- FML/FMX Only	
	6394LL	Twist-Lock Electronic Photocontrol 432-528VAC- FML/FMX Only	
Tennon Reducer	101679	Tennon Reducer, 2-3/8" to 1/2", Bronze	
Vandal Shield	FMS-VANDAL	Vandal shield (IK08) for FMS series	

**LINE DRAWINGS:**

**20W 30W with 1/2" THREAD KNUCKLE MOUNT**

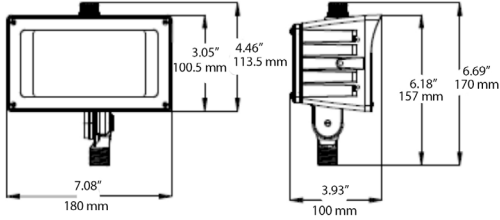

**20W 30W with Trunnion Swivel**



**50W 80W with 1/2" THREAD KNUCKLE MOUNT**



**50W 80W with TRUNNION SWIVEL MOUNT**



**120W with Slip fitter Knuckle**



**50W 80W with Slip Fitter Knuckle**



**120W with TRUNNION SWIVEL MOUNT**



**200W 310W with TRUNNION SWIVEL MOUNT**



**200W 310W with Slip fitter Knuckle**

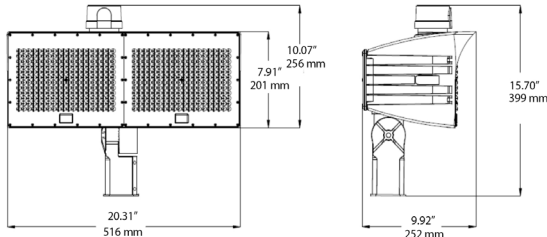

**MOUNTING DIMENSIONS:**

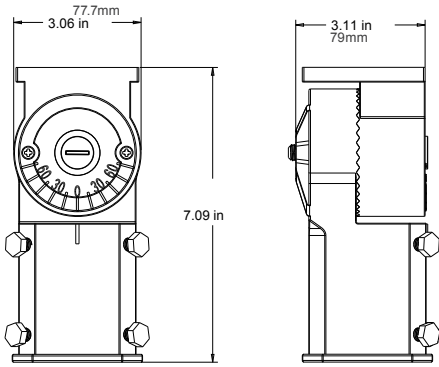

Slipfitter Knuckle (50/80/120/200/310W)



Knuckle 1/2" Thread (20/30W)

Trunnion Swivel  
(50/80/120/200/310W)



**DIMENSIONS:**

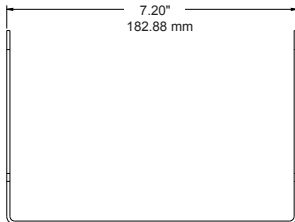

Trunnion Swivel (FMS 20/30W)

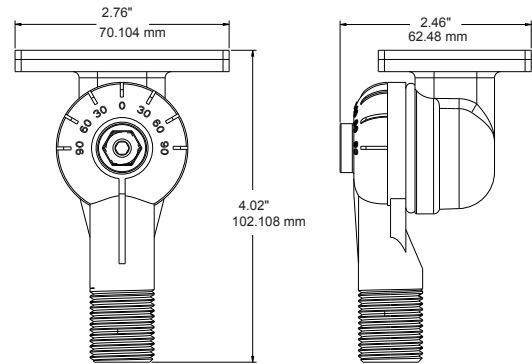

Knuckle 1/2" Thread (FMM 50/80W)

## ISOFOOTCANDLE:

Each gridline represents one mounting height.  
 For mounting heights other than noted multiply FC by the below factor.  
 Factor =  $\frac{(\text{Chart's Mtg Height})^2}{(\text{Actual Mtg Height})^2}$

### LEGEND

- |   |  |
|---|--|
| <span style="color: green;">■</span> 0.5 fc | <span style="color: orange;">■</span> 10 fc    |
| <span style="color: blue;">■</span> 1 fc    | <span style="color: darkgreen;">■</span> 20 fc |
| <span style="color: magenta;">■</span> 2 fc | <span style="color: darkblue;">■</span> 50 fc  |
| <span style="color: purple;">■</span> 5 fc  |  |

### NARROW

### WIDE

**20 WATT**  
15' ft Set back

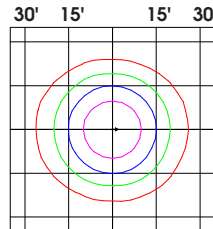

**50 WATT**  
20' ft Set back

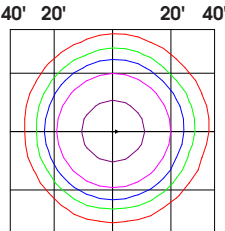
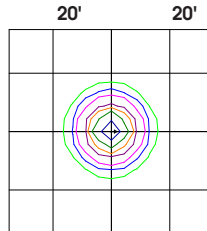

**120 WATT**  
30' ft Set back

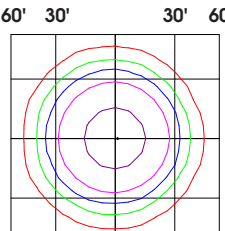
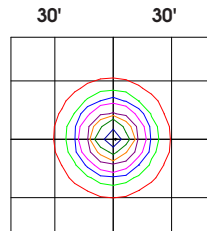

**310 WATT**  
50' ft Set back

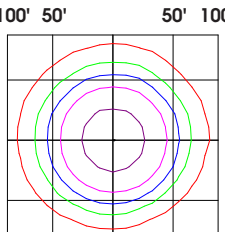
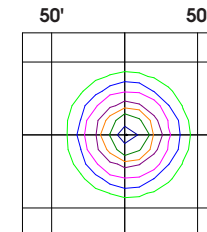

### NARROW

### WIDE

**30 WATT**  
18' ft Set back



**80 WATT**  
25' ft Set back

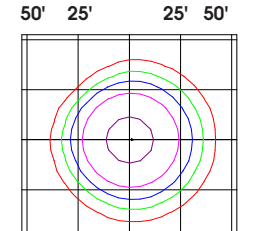
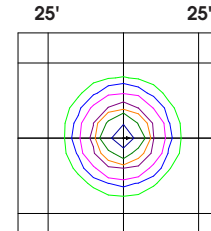

**200 WATT**  
40' ft Set back

