

LED LOW-PROFILE CANOPY
CPL SERIES



PRODUCT DESCRIPTION:

Quick to install, the LED Low-Profile Canopy is the ideal retrofit solution for 100-250W HID garage and canopy luminaires. Offered in 20, 30, 40, and 52-watt versions, with different reflector options for parking garage and canopy distributions, the CPL can address a variety of application needs.

The series offers 0-10V dimming drivers standard with an optional integral microwave motion sensor to negate interference on light output. Consuming 75 percent less energy than incumbent fixtures, the CPL series provides immediate payback and long-term energy and maintenance cost savings.



FEATURES:

- Trade Agreements Act (TAA) compliant product available - Contact MaxLite for details
- 20W replaces up to 100 watt metal halide
- 30W replaces up to 150 watt metal halide
- 40W replaces up to 175 watt metal halide
- 52W replaces up to 250 watt metal halide
- Easy one-person installation, light weight with latch allowing both hands for wire connections hanging
- Universal 120-277V operation
- Emergency Battery Backup Option
- Photocontrol and programmable dimming motion sensor options available
- Two Distribution patterns, Canopy & Parking Garage
- 10kV surge protection included standard

MOUNTING:

- Latch design to hold fixture and allows both hands for wiring
- 18" leads standard for easier pendant mounting
- Standard 3/4" NPT for pendant mounting (pendants by others)
- Standard adapter plate included for junction box mounting (junction boxes by others)
- Three side-mounted 1/2" NPT knockouts
- Cannot be mounted directly to combustible surfaces
- Beauty Plate accessory available to cover up to 14"x14" opening

ORDER STRUCTURE

FAMILY	WATTAGE (NOMINAL), EQUIVALENCY	GENERATION	VOLTAGE	DISTRIBUTIONS	CCT	FINISH	OPTIONS
CPL= Low Profile Canopy	20= 20W, replaces up to 100W MH 30= 30W, replaces up to 150W MH 40= 40W, replaces up to 175W MH 52= 52W, replaces up to 250W MH	B= Generation B	U= 120-277V H= 347-480V (30W+)	P= Parking Garage Distribution Canopy C= Distribution	40= 4000K 50= 5000K	B= Bronze	Blank= No Option EMO= Battery Backup Rated 0°C (120V or 277V only) EM2= Battery Backup Rated -20°C (120V or 277V only) PC= Photocell (120V-277V only) MS= Motion/ Daylight Sensor (120V-277V only)

CONTROLS:

Motion/Daylight Sensor with Remote Control Compatibility:

0-10V microwave-based motion sensor with integral photocontrol, allowing for three output states: 100%; 10/20/30/50% output; or 0% output. Detection area, hold time, daylight threshold, and dimming level are configurable via DIP switches. At its maximum mounting height of 32 feet, the sensor can detect motion up to 30 feet away. Sensor mounted internally, behind lens which reduces vandalism and provides a cleaner look.

A compatible remote control is available with the sensor, which allows for easy sensor configuration, reprogramming, and troubleshooting when necessary. Users should review supplementary motion sensor datasheets and the product instruction manual for detailed remote control programming and operation. In the event of loss of power, remote control programmed settings return to DIP switch programmed settings.

120-277VAC Photocontrol:

Universal voltage photocontrols turn fixture on and off based on footcandle levels to help conserve energy during daylight hours. The operating temperature of the photocontrol is -30°F-120°F. Photocell mounted external.

WARRANTY:

10-year standard warranty with labor allowance*

(further details available at www.maxlite.com/warranties)

*Warranty Limitations: Product must be rated for the application per the Product Data Sheet (PDS); operated ≤16 hrs; in ambient of -29°F to 104°F. *Up to \$25/unit; labor allowances of up to \$500/unit available for purchase – contact MaxLite representative for details.

MaxLite Makes It!



Don't see what you need? Additional wattages and specifications available upon request - contact your MaxLite rep!

SPECIFICATIONS

		CPL20UB50XXXX	CPL30UB50XXXX	CPL40UB50XXXX	CPL52UB50XXXX
ITEM	SPECIFICATION	DETAILS			
GENERAL PERFORMANCE	Power Consumption (W)	20W	30W	40W	52W
	Equivalent Wattage	up to 100W MH	up to 150W MH	up to 175W MH	up to 250W MH
	Parking Garage - Lumens Delivered	2278 lm	3329 lm	4713 lm	6347 lm
	Canopy Distribution - Lumens Delivered	2374 lm	3431 lm	4935 lm	6539 lm
	Efficacy (lm/W)	120-125	115-118	119-124	123-127
	CRI	≥70			
	Color Temperature (K)	4000K and 5000K			
ELECTRICAL	L70 Lumen Maintenance (hours)	≥100,000 Hrs.			
	Power Factor	≥0.90			
	Input Voltage	120-277V			
	Dimming	0-10V. Dimming Range: 10%-100%			
PHYSICAL	Surge Protection	10kV surge protection included standard			
	Housing	Die-cast Aluminium			
	Lens	Polycarbonate			
CERTIFICATION	Operating Temperature	-40°F to 104°F or -40°C to 40°C			
	Certification	cULus, Supports Title 24 Compliance			
	Material Usage	RoHS compliant; no mercury			
	Environment	Outdoor, wet location			
QUALIFICATION	Warranty	10 Year warranty*			
	DesignLight Consortium	DLC 4.2 Premium			

ORDERING:

ORDER CODE	MODEL NUMBER	DLC PRODUCT ID	NOMINAL WATTAGE	EQUIVALENCY	DISTRIBUTION
1408347	CPL20BUC50B	P3OZNCNPN	20W	100W MH	Canopy
1408349	CPL20BUP50B	PNH1HBCF	20W	100W MH	Parking Garage
102005	CPL30BUC50B	POC9WZRJ	30W	150W MH	Canopy
102001	CPL30BUP50B	PJ6N9J4W	30W	150W MH	Parking Garage
102010	CPL40BUC50B	PQKC3148	40W	175W MH	Canopy
101024	CPL40BUP50B	P0ZD912L	40W	175W MH	Parking Garage
102339	CPL52BUC50B	P0ZN6Q1A	50W	250W MH	Canopy
102335	CPL52BUP50B	PZYTSGJ7	50W	250W MH	Parking Garage

ACCESSORIES			
ORDER CODE	MODEL NUMBER	DESCRIPTION	ACCESSORIES IMAGE
108133	RMHYTHRC-05	REMOTE CTRL PROGRAMMING HC403VRC/HC419VRC	
1409168	CPL-15SQ-PLATE*	CPL SERIES ALUMINUM BEAUTY PLATE FOR 15" x 15" SQUARE HOLES, BRONZE*	

*See page 3 for CPL Cover Plate dimensions

DIMENSIONS

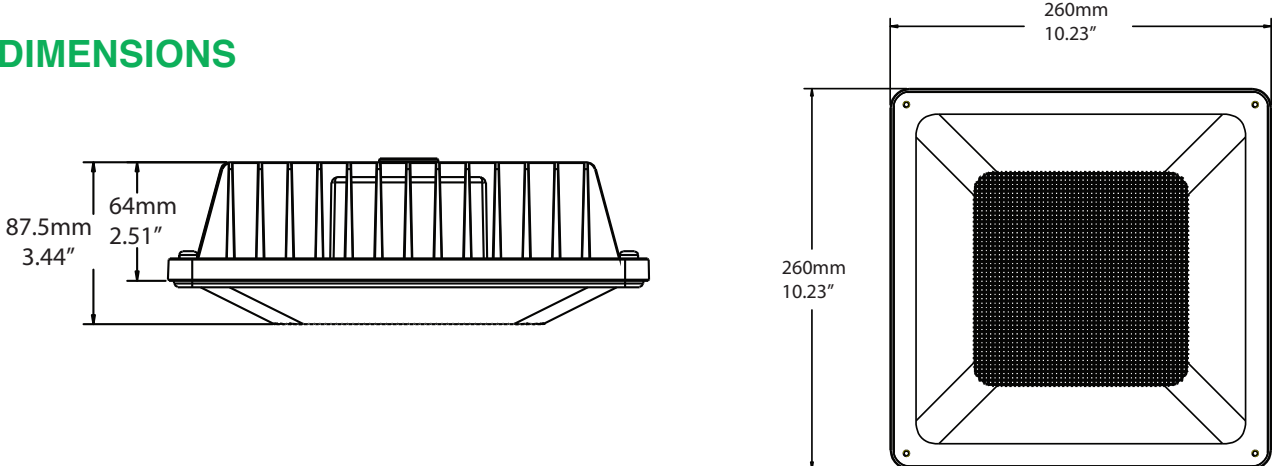

Non Emergency Battery Backup

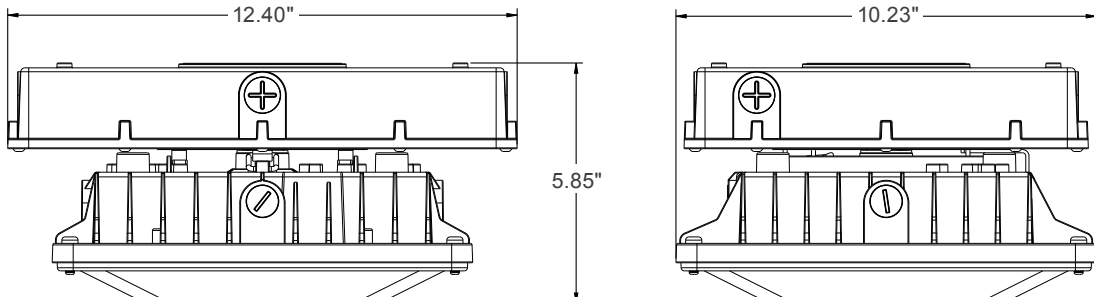

Emergency Battery Backup Option

CPL PLATE DIMENSIONS

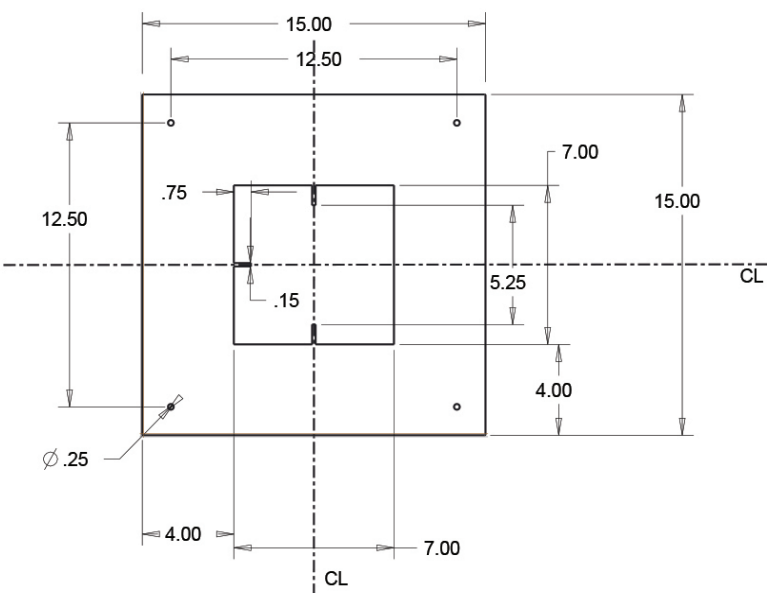

CPL20 FOOTCANDLE:

Each gridline represents one mounting height.
For mounting heights other than noted multiply FC by the below factor.

$$\text{Factor} = \frac{(\text{Chart's Mtg Height})^2}{(\text{Actual Mtg Height})^2}$$

LEGEND

- 0.2 fc
- 0.5 fc
- 1 fc
- 2 fc
- 5 fc

Layouts based on 4000K or 5000K.
Results are 3-5% less for 3000K.
Consult IES file for more precise calculations.

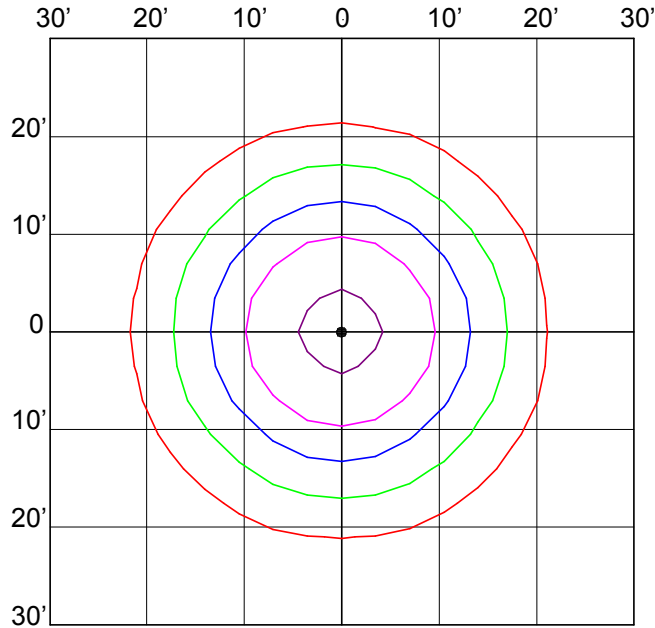

20W, Canopy
2,415 Lumens
10' Mounting Height
Foot-candle Correction Factor:

New Height:	8'	10'	15'	20'
Multiply by:	1.56	1	0.44	0.25

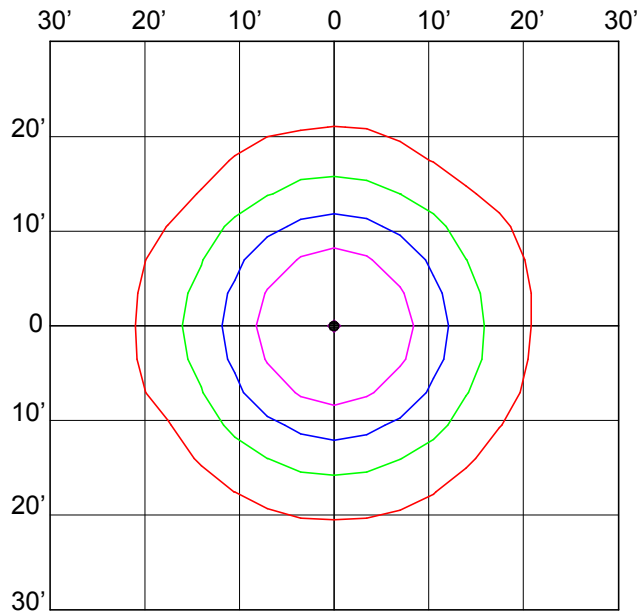

20W, Parking
2,200 Lumens
10' Mounting Height
Foot-candle Correction Factor:

New Height:	8'	10'	15'	20'
Multiply by:	1.56	1	0.44	0.25

CPL40 FOOTCANDLE:

Each gridline represents one mounting height.

For mounting heights other than noted multiply FC by the below factor.

$$\text{Factor} = \frac{(\text{Chart's Mtg Height})^2}{(\text{Actual Mtg Height})^2}$$

LEGEND

- 0.2 fc
- 0.5 fc
- 1 fc
- 2 fc
- 5 fc

Layouts based on 4000K or 5000K.
Results are 3-5% less for 3000K.
Consult IES file for more precise calculations.

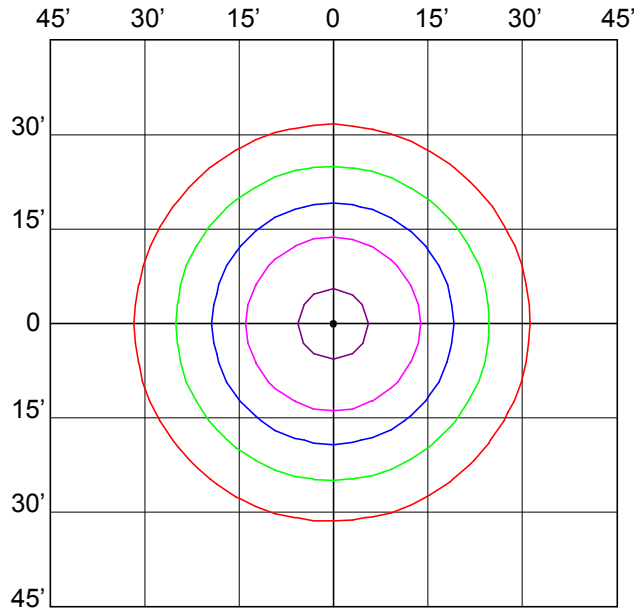

40W, Canopy
5,150 Lumens
15' Mounting Height

Foot-candle Correction Factor:

New Height:	10'	15'	20'	25'
Multiply by:	2.25	1	0.56	0.36

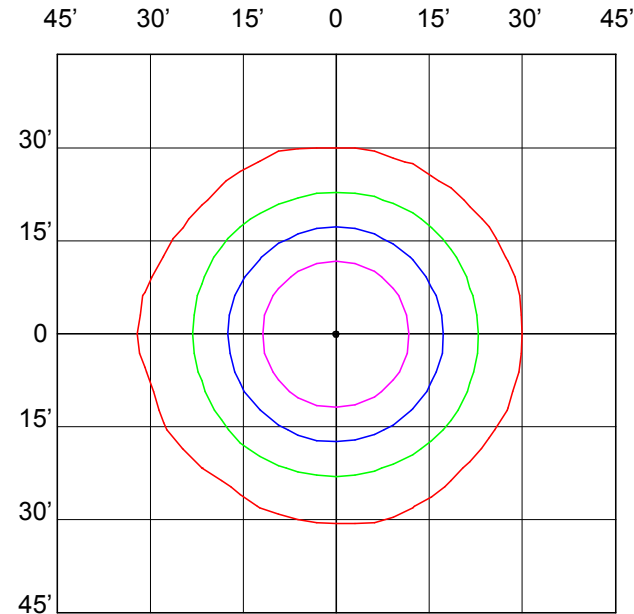

40W, Parking
4,645 Lumens
15' Mounting Height

Foot-candle Correction Factor:

New Height:	10'	15'	20'	25'
Multiply by:	2.25	1	0.56	0.36

CPL52 FOOTCANDLE:

Each gridline represents one mounting height.

For mounting heights other than noted multiply FC by the below factor.

$$\text{Factor} = \frac{(\text{Chart's Mtg Height})^2}{(\text{Actual Mtg Height})^2}$$

LEGEND

- 0.2 fc
- 0.5 fc
- 1 fc
- 2 fc
- 5 fc

Layouts based on 4000K or 5000K.
Results are 3-5% less for 3000K.
Consult IES file for more precise calculations.

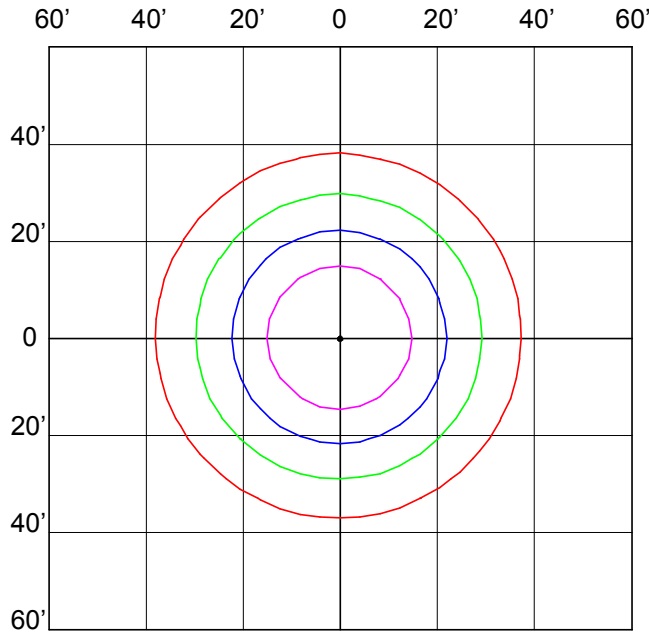

58W, Canopy
6,510 Lumens
20' Mounting Height
Foot-candle Correction Factor:

New Height:	10'	15'	20'	25'
Multiply by:	4	1.78	1	0.64

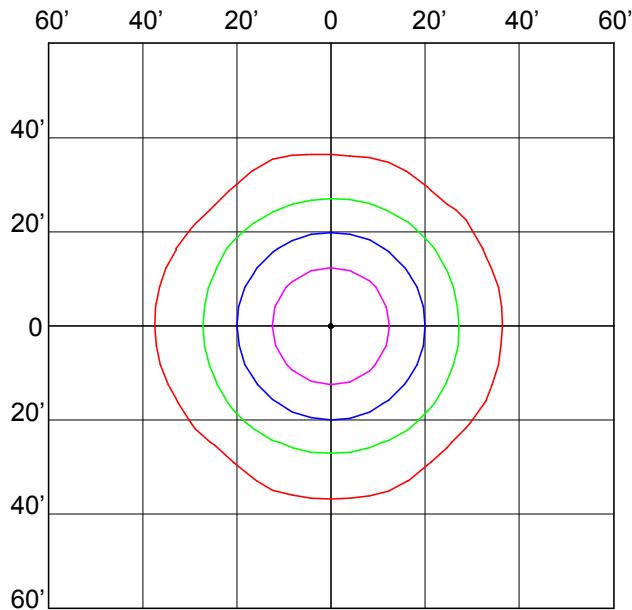

58W, Parking
6,095 Lumens
20' Mounting Height
Foot-candle Correction Factor:

New Height:	10'	15'	20'	25'
Multiply by:	4	1.78	1	0.64