

## LED SLIM AREA LIGHTS

### AR SERIES

Fixture shown with Slipfitter Knuckle



60/75W Model

Fixture shown with Adjustable Wall Mount and Motion Sensor



100/145W Model

Fixture shown with Straight Arm



200/310W Model

Fixture shown with Flexible Tilt Arm and Motion Sensor



### PRODUCT DESCRIPTION:

The LED Slim Area Lights deliver class-leading efficacy in a lightweight design that can be effortlessly applied to new and retrofit outdoor projects. Offered in lumen packages ranging from 7,700lm to over 40,000+lm, the AR Series achieves up to 158 lumens per watt while providing significant long-term energy and maintenance cost savings.

### FEATURES:

- CCT selectable between 3000K/4000K/5000K
- Replaces up to 1,000W MH equivalent
- Universal 120-277V dimming driver standard, 277-480V available
- Controls Ready - simple plug and play Sensor Receptacle enables installation of c-Max, photocell, motion sensor/PC and future network controls without changing the fixture
- Meets ANSI 3G vibration standard for bridges and overpasses
- Comes with 41" 18/3 SO cord
- Trade Agreements Act (TAA) compliant product available - Contact MaxLite for details

### MOUNTING:

- 7.5" Straight Arm<sup>1</sup>, includes labor saving slot pattern which eliminates need to drill holes on most retrofits
- Trunnion Swivel
- 2-3/8" - 3" OD Slipfitter Knuckle
- Flexible Tilt Arm<sup>1</sup>, includes labor saving slot pattern which eliminates need to drill holes on most retrofits
- Adjustable Wall Mount

### WARRANTY:

10-year standard warranty with labor allowance\* (further details available at [www.maxlite.com/warranties](http://www.maxlite.com/warranties))

\*Warranty Limitations: Product must be rated for the application per the Product Data Sheet (PDS); operated ≤16 hrs/day; in ambient of -29°F to 104°F. \*Up to \$25/unit; labor allowances of up to \$500/unit available for purchase – contact MaxLite representative for details.



Mounting Arms include labor saving slot pattern

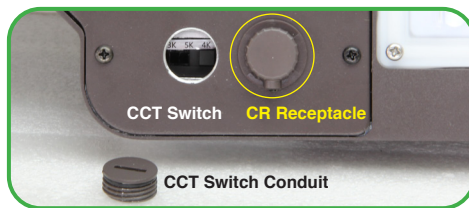







| MODEL SELECTION |  | Typical order example: AR60UT5-50BK      |  |   |                                    |  |   |  |
|-----------------|--|--|--|---|------------------------------------|--|---|--|
| AR              |  |  |  |   |                                    |  |   |  |
| FAMILY          | NOMINAL WATTAGE  | VOLTAGE                                  | DISTRIBUTION   |   | CCT                                | FINISH   | MOUNTING  | OPTIONS  |
| AR= Area Light  | <b>60=</b> 60W, 250W MH/HPS equivalent<br><b>75=</b> 75W, 300W MH/HPS equivalent<br><b>100=</b> 100W, 400W MH/HPS equivalent<br><b>145=</b> 145W, 400W MH/HPS equivalent<br><b>200=</b> 200W, 750W MH/HPS equivalent<br><b>310=</b> 310W, 1,000W MH/HPS equivalent | <b>U=</b> 120-277V<br><b>H=</b> 277-480V | <b>T3=</b> Type III<br><b>T4=</b> Type IV<br><b>T5=</b> Type V | - | <b>CS=</b> CCT Selectable (3/4/5K) | <b>B=</b> Bronze<br><br><i>Contact MaxLite for additional finishes</i> | <b>A=</b> Straight Arm <sup>1</sup><br><b>K=</b> 2-3/8" -3" OD Slipfitter Knuckle<br><b>T=</b> Trunnion Swivel<br><b>F=</b> Flexible (Adjustable) Arm <sup>1</sup><br><b>W=</b> Adjustable Wall Mount | <b>CR=</b> Controls Ready (Order field installable c-Max control node separately)<br><br><b>RPC=</b> NEMA 3-pin receptacle (NEMA twist lock Photocell sold separately)<br><br><b>PR7=</b> NEMA 7-Pin receptacle (control module sold separately) |

**NOTE:**

<sup>1</sup> Arm Mounts fit square poles, for round poles add a round pole adapter - see Accessories table.

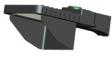
**DLC PREMIUM LISTINGS**

| MODEL #  | DLC ID # | MODEL #   | DLC ID # | MODEL #   | DLC ID # |
|----------|----------|-----------|----------|-----------|----------|
| AR60, T3 | PC7U5Q3R | AR100, T3 | PMR1F0BT | AR200, T3 | P72VJ33N |
| AR60, T4 | PM79R3OT | AR100, T4 | PUCKC89T | AR200, T4 | PIRHLN0X |
| AR60, T5 | P3LDQEBP | AR100, T5 | P4W71WQ2 | AR200, T5 | P9H4BZS6 |
| AR75, T3 | PN6EBZ0Q | AR145, T3 | PG46WKYG | AR310, T3 | POWODT95 |
| AR75, T4 | PFU2GBWZ | AR145, T4 | PJ32ZMFD | AR310, T4 | PXBCH4XH |
| AR75, T5 | PV1RC991 | AR145, T5 | PDCHQFHI | AR310, T5 | PYRAGHCJ |

| ACCESSORIES    |            |  |   |
|----------------|------------|--|---|
| MODEL #        | ORDER CODE | DESCRIPTION  | IMAGE   |
| RPA3-B         | 106239     | 3" ROUND POLE ADAPTER, SLOTTED DRILL PATTERN, BRONZE   |   |
| RPA4-B         | 106240     | 4" ROUND POLE ADAPTER, SLOTTED DRILL PATTERN, BRONZE   |   |
| RPA5-B         | 106241     | 5" ROUND POLE ADAPTER, SLOTTED DRILL PATTERN, BRONZE   |   |
| CN-RDPCB†      | 105569     | C-MAX PHOTOCELL NODE ROUND, BRONZE, IP66, USED WITH CONTROLS READY FIXTURES                            |   |
| CN-RDMSB†*     | 105566     | C-MAX CONTROL NODE ROUND, PIR MOTION SENSOR/PHOTOCELL, BRONZE, IP66, USED WITH CONTROLS READY FIXTURES |  |
| CN-REMOTE      | 105567     | C-MAX REMOTE CONTROL, AT LEAST 1 PER PROJECT TO PROGRAM MOTION SENSOR (CN-RDMSB)                       |  |
| AR-S-HS-GEN2-B | 103658     | HOUSE SIDE SHIELD FOR AR GEN 2 SERIES, BRONZE FINISH, FITS 60W/75W/100W/145W                           |  |
| AR-MAL-L-HS-B  | 1408946    | HOUSE SIDE SHIELD, BRONZE FINISH, FITS 200/310W  |  |
| PCTL-UNV       | 105038     | TWIST-LOCK ELECTRONIC PHOTOCONTROL 120/208/240/277V (USED WITH RPC OPTION, NOT C-MAX)                  |  |
| PCTL-HV        | 105866     | TWIST-LOCK ELECTRONIC PHOTOCONTROL 480V (USED WITH RPC OPTION, NOT C-MAX)                              |  |
| MLRTLPCRSP     | 96268      | SHORTING CAP FOR NEMA TWIST LOCK PHOTOCELL RECEPTACLE (3, 5 OR 7 PIN)                                  |  |

† Requires 1.5M Allen wrench

\* Requires at least 1 remote control (CN-REMOTE) per project to program

| SPECIFICATIONS        |    | AR60   | AR75          | AR100         | AR145         | AR200         | AR310         |
|-----------------------|----|--|---------------|---------------|---------------|---------------|---------------|
| <b>SPECIFICATION</b>  |    | <b>DETAILS</b>   |               |               |               |               |               |
| Nominal Wattage (W)   |    | 60   | 75            | 100           | 145           | 200           | 310           |
| CCT                   |    | Selectable between 3000K, 4000K or 5000K   |               |               |               |               |               |
| CRI                   |    | ≥70  |               |               |               |               |               |
| Lumens Type III       |    | 8,050-8,800  | 9,950-10,900  | 13,500-14,780 | 19,170-20,950 | 27,600-30,190 | 40,350-44,100 |
| BUG Rating            | 3K | B1-U0-G2   | B2-U0-G2      | B2-U0-G2      | B3-U0-G3      | B3-U0-G3      | B3-U0-G4      |
|                       | 4K | B2-U0-G2   | B2-U0-G2      | B2-U0-G3      | B3-U0-G3      | B3-U0-G4      | B4-U0-G4      |
|                       | 5K | B1-U0-G2   | B2-U0-G2      | B2-U0-G3      | B3-U0-G3      | B3-U0-G3      | B3-U0-G4      |
| Lumens Type IV        |    | 7,900-8,650  | 9,790-10,700  | 13,270-14,500 | 18,800-20,550 | 27,100-29,650 | 39,600-43,350 |
| BUG Rating            | 3K | B1-U0-G2   | B1-U0-G2      | B2-U0-G3      | B2-U0-G3      | B3-U0-G4      | B3-U0-G5      |
|                       | 4K | B1-U0-G2   | B2-U0-G2      | B2-U0-G3      | B3-U0-G3      | B3-U0-G5      | B3-U0-G5      |
|                       | 5K | B1-U0-G2   | B1-U0-G2      | B2-U0-G3      | B2-U0-G3      | B3-U0-G5      | B3-U0-G5      |
| Lumens Type V         |    | 8,190-8,950  | 10,140-11,050 | 13,750-15,050 | 19,500-21,340 | 28,100-30,730 | 41,090-44,940 |
| BUG Rating            | 3K | B3-U0-G1   | B3-U0-G2      | B4-U0-G2      | B4-U0-G2      | B5-U0-G3      | B5-U0-G4      |
|                       | 4K | B3-U0-G2   | B3-U0-G2      | B4-U0-G2      | B4-U0-G2      | B5-U0-G3      | B5-U0-G4      |
|                       | 5K | B3-U0-G1   | B3-U0-G2      | B4-U0-G2      | B4-U0-G2      | B5-U0-G3      | B5-U0-G4      |
| Efficacy (lm/W)       |    | 126-149  | 130-154       | 130-153       | 130-154       | 134-158       | 133-157       |
| Dimming               |    | 0-10V and High-end trim  |               |               |               |               |               |
| Power Factor          |    | ≥0.90  |               |               |               |               |               |
| Input Voltage         |    | 120-277V, 277-480V option  |               |               |               |               |               |
| Surge Protection      |    | Standard: 120-277V 10kV, 277-480V 20kA; Special order for 120-277V 20kA                |               |               |               |               |               |
| Housing               |    | Die Cast Aluminum with corrosion resistant powder coat finish                          |               |               |               |               |               |
| Lens                  |    | Impact resistant, UV stabilized Polycarbonate  |               |               |               |               |               |
| Mounting              |    | Die Cast Aluminum: Straight and Flexible Arm, Slip Fitter, Trunnion or Adjustable Wall |               |               |               |               |               |
| EPA (sq ft) 0°/90°    |    | 0.43/1.34  |               | 0.43/1.64     |               | 0.49/2.26     |               |
| Operating Temperature |    | -40°F to 104°F (-40°C to 40°C)   |               |               |               |               |               |
| Listings              |    | FCC, cULus, RoHS, T24 Compliant, ANSI 3G Vibration (Bridges and Overpasses)            |               |               |               |               |               |
| Environment           |    | IP65, WL   |               |               |               |               |               |
| Warranty              |    | 10 Years   |               |               |               |               |               |

**DIMENSIONS:**

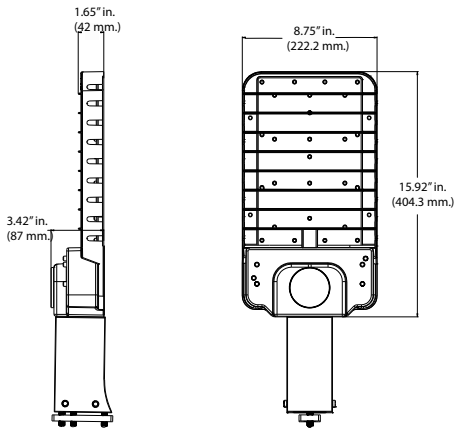

60/75W Model

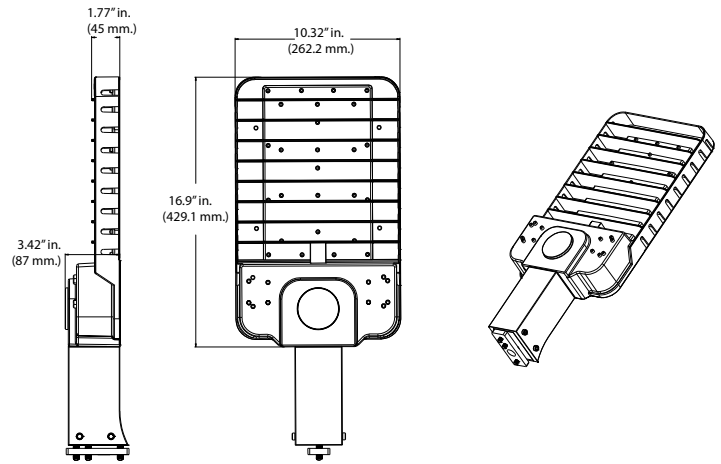

100/145W Model

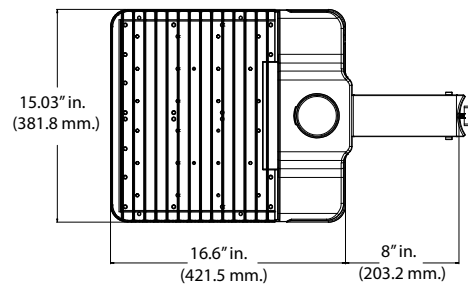
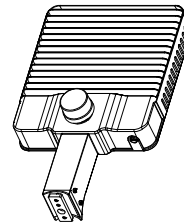
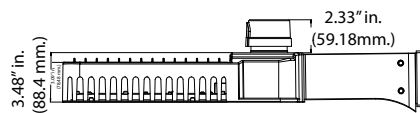

200/310W Model

**MOUNTING:**

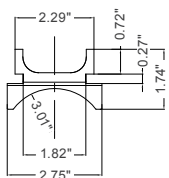
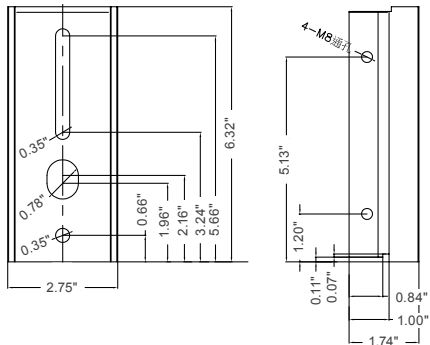

Round Pole Adapter (RPA) 3"

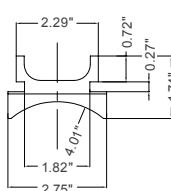
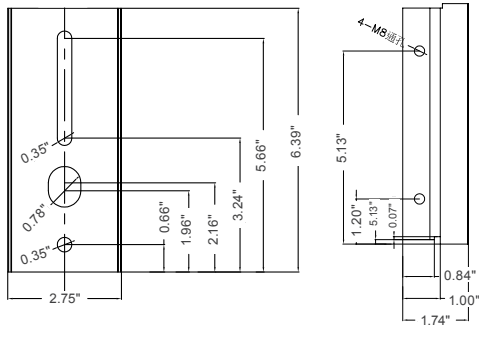

Round Pole Adapter (RPA) 4"

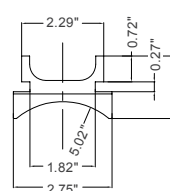
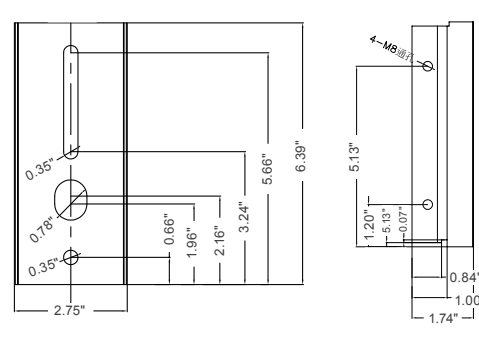

Round Pole Adapter (RPA) 5"

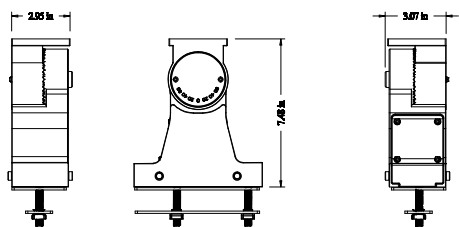
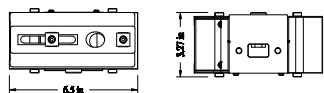

Adjustable Square Arm

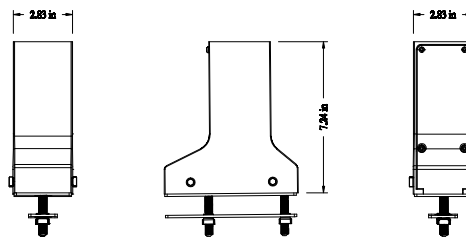
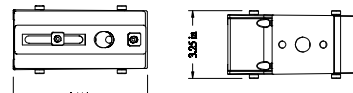

Fixed Square Arm

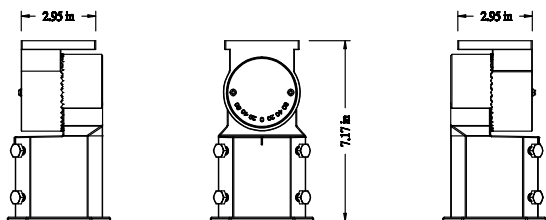
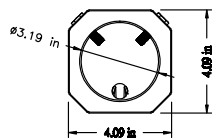

Slipfitter Arm (fits 2 3/8"-3" OD)

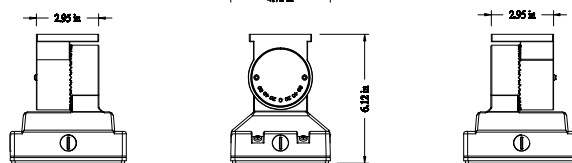
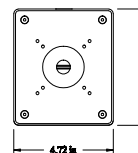

Adjustable Wall Mount

**ISOFOOTCANDLE:**

Each gridline represents one mounting height.

For mounting heights other than noted multiply FC by the below factor.

$$\text{Factor} = \frac{(\text{Chart's Mtg Height})^2}{(\text{Actual Mtg Height})^2}$$

**LEGEND**

- 0.5 fc
- 1 fc
- 2 fc
- 5 fc
- 10 fc

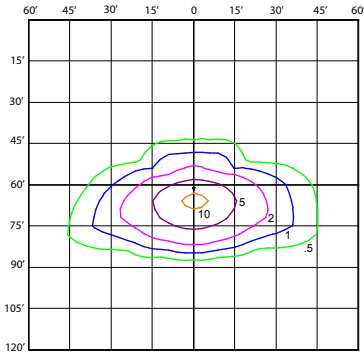

TYPE 3 - 60W  
15' MOUNTING HEIGHT

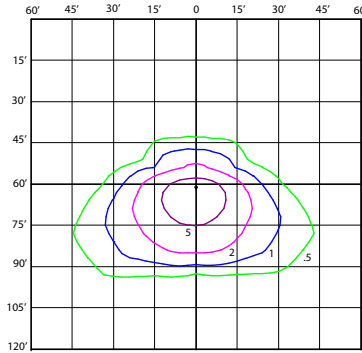

TYPE 4 - 60W  
15' MOUNTING HEIGHT

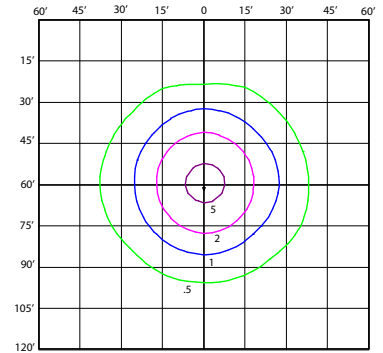

TYPE 5 - 60W  
15' MOUNTING HEIGHT

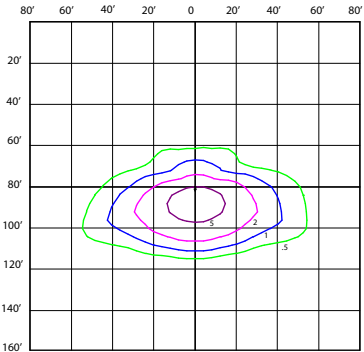

TYPE 3 - 75W  
20' MOUNTING HEIGHT

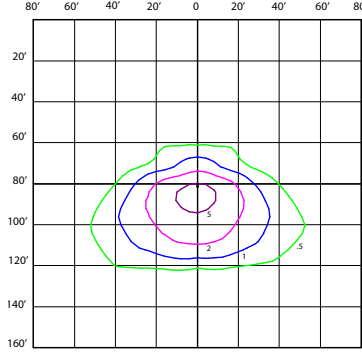

TYPE 4 - 75W  
20' MOUNTING HEIGHT

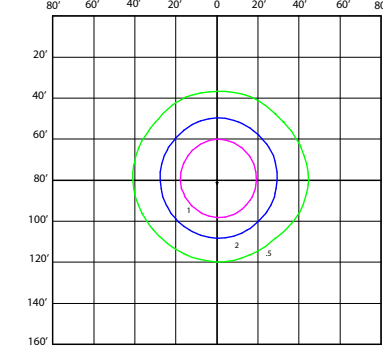

TYPE 5 - 75W  
20' MOUNTING HEIGHT

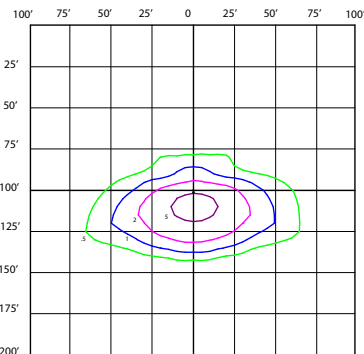

TYPE 3 - 100W  
25' MOUNTING HEIGHT

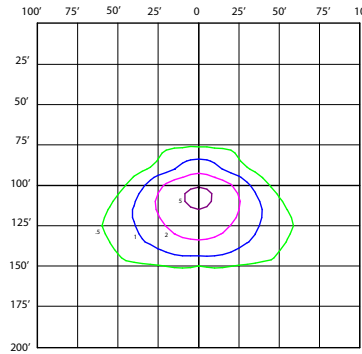

TYPE 4 - 100W  
25' MOUNTING HEIGHT

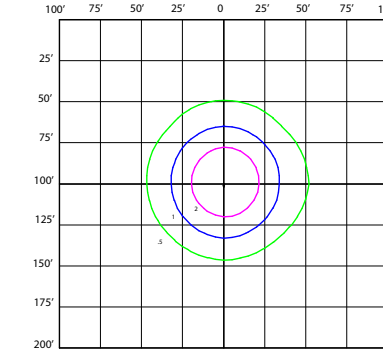

TYPE 5 - 100W  
25' MOUNTING HEIGHT

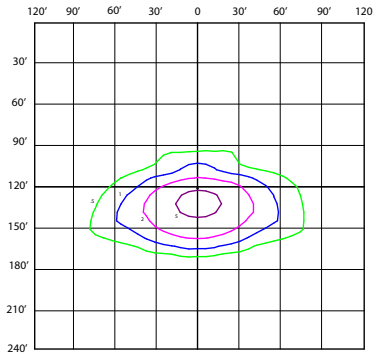

TYPE 3 - 145W  
30' MOUNTING HEIGHT

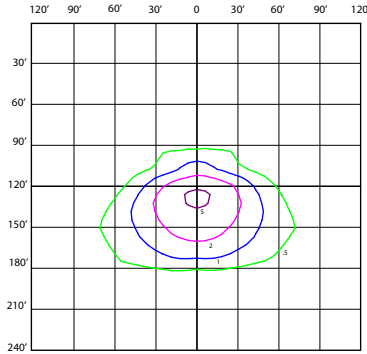

TYPE 4 - 145W  
30' MOUNTING HEIGHT

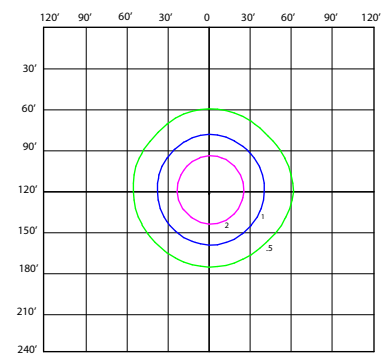

TYPE 5 - 145W  
30' MOUNTING HEIGHT

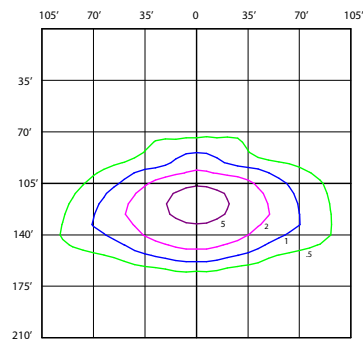

TYPE 3 - 200W  
35' MOUNTING HEIGHT

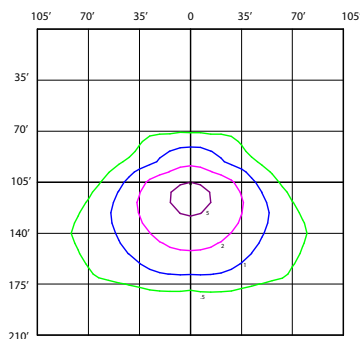

TYPE 4 - 200W  
35' MOUNTING HEIGHT

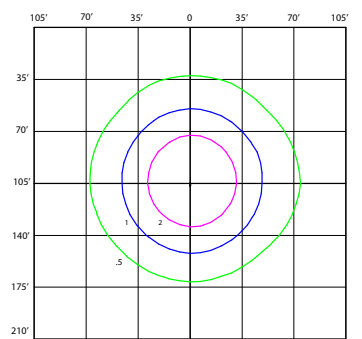

TYPE 5 - 200W  
35' MOUNTING HEIGHT

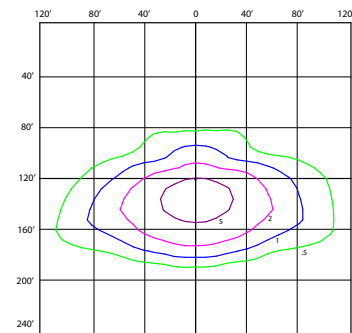

TYPE 3 - 310W  
40' MOUNTING HEIGHT

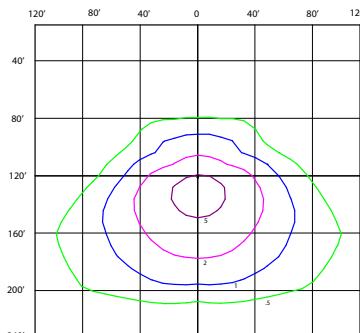

TYPE 4 - 310W  
40' MOUNTING HEIGHT

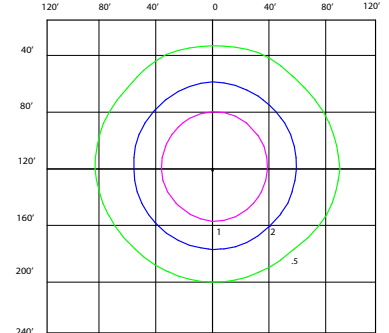

TYPE 5 - 310W  
40' MOUNTING HEIGHT