

## LED SLIM AREA LIGHTS

### AR SERIES

Fixture shown with Slipfitter Knuckle



60/75W Model

Fixture shown with Adjustable Wall Mount and Motion Sensor



100/145W Model

Fixture shown with Straight Arm



Fixture shown with Flexible Tilt Arm and Motion Sensor



200/310W Model



Mounting Arms include labor saving slot pattern

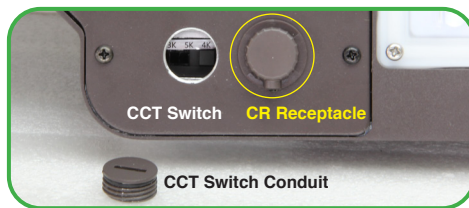

### PRODUCT DESCRIPTION:

The LED Slim Area Lights deliver class-leading efficacy in a lightweight design that can be effortlessly applied to new and retrofit outdoor projects. Offered in lumen packages ranging from 7,700lm to over 40,000+lm, the AR Series achieves up to 158 lumens per watt while providing significant long-term energy and maintenance cost savings.

### FEATURES:

- CCT selectable between 3000K/4000K/5000K
- Replaces up to 1,000W MH equivalent
- Universal 120-277V dimming driver standard, 277-480V available
- Controls Ready - simple plug and play Sensor Receptacle enables installation of c-Max, photocell, motion sensor/PC and future network controls without changing the fixture
- Meets ANSI 3G vibration standard for bridges and overpasses
- Comes with 41" 18/3 SO cord
- Trade Agreements Act (TAA) compliant product available - Contact MaxLite for details

### MOUNTING:

- 7.5" Straight Arm<sup>1</sup>, includes labor saving slot pattern which eliminates need to drill holes on most retrofits
- Trunnion Swivel
- 2-3/8" - 3" OD Slipfitter Knuckle
- Flexible Tilt Arm<sup>1</sup>, includes labor saving slot pattern which eliminates need to drill holes on most retrofits
- Adjustable Wall Mount

### WARRANTY:

10-year standard warranty with labor allowance\* (further details available at [www.maxlite.com/warranties](http://www.maxlite.com/warranties))

\*Warranty Limitations: Product must be rated for the application per the Product Data Sheet (PDS); operated ≤16 hrs/day; in ambient of -29°F to 104°F. \*Up to \$25/unit; labor allowances of up to \$500/unit available for purchase – contact MaxLite representative for details.

MODEL SELECTION		Typical order example: AR60UT5-50BK						
AR								
FAMILY	NOMINAL WATTAGE	VOLTAGE	DISTRIBUTION		CCT	FINISH	MOUNTING	OPTIONS
AR= Area Light	<b>60=</b> 60W, 250W MH/HPS equivalent <b>75=</b> 75W, 300W MH/HPS equivalent <b>100=</b> 100W, 400W MH/HPS equivalent <b>145=</b> 145W, 400W MH/HPS equivalent <b>200=</b> 200W, 750W MH/HPS equivalent <b>310=</b> 310W, 1,000W MH/HPS equivalent	<b>U=</b> 120-277V <b>H=</b> 277-480V	<b>T3=</b> Type III <b>T4=</b> Type IV <b>T5=</b> Type V	-	<b>CS=</b> CCT Selectable (3/4/5K)	<b>B=</b> Bronze  <i>Contact MaxLite for additional finishes</i>	<b>A=</b> Straight Arm <sup>1</sup> <b>K=</b> 2-3/8" -3" OD Slipfitter Knuckle <b>T=</b> Trunnion Swivel <b>F=</b> Flexible (Adjustable) Arm <sup>1</sup> <b>W=</b> Adjustable Wall Mount	<b>CR=</b> Controls Ready (Order field installable c-Max control node separately)  <b>RPC=</b> NEMA 3-pin receptacle (NEMA twist lock Photocell sold separately)  <b>PR7=</b> NEMA 7-Pin receptacle (control module sold separately)

### NOTE:







<sup>1</sup> Arm Mounts fit square poles, for round poles add a round pole adapter - see Accessories table.

**DLC PREMIUM LISTINGS**

MODEL #	DLC ID #
AR60, T3	PC7U5Q3R
AR60, T4	PM79R3OT
AR60, T5	P3LDQEBP
AR75, T3	PN6EBZ0Q
AR75, T4	PFU2GBWZ
AR75, T5	PV1RC991

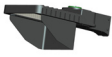
MODEL #	DLC ID #
AR100, T3	PMR1F0BT
AR100, T4	PUCKC89T
AR100, T5	P4W71WQ2
AR145, T3	PG46WKYG
AR145, T4	PJ32ZMFD
AR145, T5	PDCHQFHI

MODEL #	DLC ID #
AR200, T3	P72VJ33N
AR200, T4	PIRHLN0X
AR200, T5	P9H4BZS6
AR310, T3	POWODT95
AR310, T4	PXBCH4XH
AR310, T5	PYRAGHCJ

ACCESSORIES			
MODEL #	ORDER CODE	DESCRIPTION	IMAGE
RPA3-B	106239	3" ROUND POLE ADAPTER, SLOTTED DRILL PATTERN, BRONZE	
RPA4-B	106240	4" ROUND POLE ADAPTER, SLOTTED DRILL PATTERN, BRONZE	
RPA5-B	106241	5" ROUND POLE ADAPTER, SLOTTED DRILL PATTERN, BRONZE	
CN-RDPCB†	105569	C-MAX PHOTOCELL NODE ROUND, BRONZE, IP66, USED WITH CONTROLS READY FIXTURES	
CN-RDMSB†*	105566	C-MAX CONTROL NODE ROUND, PIR MOTION SENSOR/PHOTOCELL, BRONZE, IP66, USED WITH CONTROLS READY FIXTURES	
CN-REMOTE	105567	C-MAX REMOTE CONTROL, AT LEAST 1 PER PROJECT TO PROGRAM MOTION SENSOR (CN-RDMSB)	
AR-S-HS-GEN2-B	103658	HOUSE SIDE SHIELD FOR AR GEN 2 SERIES, BRONZE FINISH, FITS 60W/75W/100W/145W	
AR-MAL-L-HS-B	1408946	HOUSE SIDE SHIELD, BRONZE FINISH, FITS 200/310W	
PCTL-UNV	105038	TWIST-LOCK ELECTRONIC PHOTOCONTROL 120/208/240/277V (USED WITH RPC OPTION, NOT C-MAX)	
PCTL-HV	105866	TWIST-LOCK ELECTRONIC PHOTOCONTROL 480V (USED WITH RPC OPTION, NOT C-MAX)	
MLRTLPCRSP	96268	SHORTING CAP FOR NEMA TWIST LOCK PHOTOCELL RECEPTACLE (3, 5 OR 7 PIN)	

† Requires 1.5M Allen wrench

\* Requires at least 1 remote control (CN-REMOTE) per project to program

SPECIFICATIONS		AR60	AR75	AR100	AR145	AR200	AR310
<b>SPECIFICATION</b>		<b>DETAILS</b>					
Nominal Wattage (W)		60	75	100	145	200	310
CCT		Selectable between 3000K, 4000K or 5000K					
CRI		≥70					
Lumens Type III		8,050-8,800	9,950-10,900	13,500-14,780	19,170-20,950	27,600-30,190	40,350-44,100
BUG Rating	3K	B1-U0-G2	B2-U0-G2	B2-U0-G2	B3-U0-G3	B3-U0-G3	B3-U0-G4
	4K	B2-U0-G2	B2-U0-G2	B2-U0-G3	B3-U0-G3	B3-U0-G4	B4-U0-G4
	5K	B1-U0-G2	B2-U0-G2	B2-U0-G3	B3-U0-G3	B3-U0-G3	B3-U0-G4
Lumens Type IV		7,900-8,650	9,790-10,700	13,270-14,500	18,800-20,550	27,100-29,650	39,600-43,350
BUG Rating	3K	B1-U0-G2	B1-U0-G2	B2-U0-G3	B2-U0-G3	B3-U0-G4	B3-U0-G5
	4K	B1-U0-G2	B2-U0-G2	B2-U0-G3	B3-U0-G3	B3-U0-G5	B3-U0-G5
	5K	B1-U0-G2	B1-U0-G2	B2-U0-G3	B2-U0-G3	B3-U0-G5	B3-U0-G5
Lumens Type V		8,190-8,950	10,140-11,050	13,750-15,050	19,500-21,340	28,100-30,730	41,090-44,940
BUG Rating	3K	B3-U0-G1	B3-U0-G2	B4-U0-G2	B4-U0-G2	B5-U0-G3	B5-U0-G4
	4K	B3-U0-G2	B3-U0-G2	B4-U0-G2	B4-U0-G2	B5-U0-G3	B5-U0-G4
	5K	B3-U0-G1	B3-U0-G2	B4-U0-G2	B4-U0-G2	B5-U0-G3	B5-U0-G4
Efficacy (lm/W)		126-149	130-154	130-153	130-154	134-158	133-157
Dimming		0-10V and High-end trim					
Power Factor		≥0.90					
Input Voltage		120-277V, 277-480V option					
Surge Protection		Standard: 120-277V 10kV, 277-480V 20kA; Special order for 120-277V 20kA					
Housing		Die Cast Aluminum with corrosion resistant powder coat finish					
Lens		Impact resistant, UV stabilized Polycarbonate					
Mounting		Die Cast Aluminum: Straight and Flexible Arm, Slip Fitter, Trunnion or Adjustable Wall					
EPA (sq ft) 0°/90°		0.43/1.34		0.43/1.64		0.49/2.26	
Operating Temperature		-40°F to 104°F (-40°C to 40°C)					
Listings		FCC, cULus, RoHS, T24 Compliant, ANSI 3G Vibration (Bridges and Overpasses)					
Environment		IP65, WL					
Warranty		10 Years					

**DIMENSIONS:**



60/75W Model



100/145W Model



200/310W Model

**MOUNTING:**

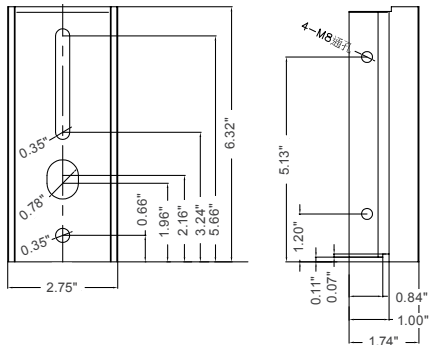

Round Pole Adapter (RPA) 3"



Round Pole Adapter (RPA) 4"



Round Pole Adapter (RPA) 5"



Adjustable Square Arm

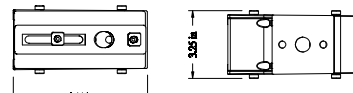

Fixed Square Arm

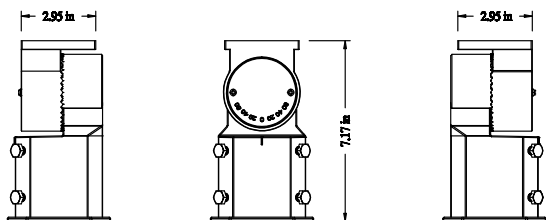

Slipfitter Arm (fits 2 3/8"-3" OD)



Adjustable Wall Mount

**ISOFOOTCANDLE:**

Each gridline represents one mounting height.

For mounting heights other than noted multiply FC by the below factor.

Factor =  $\frac{(\text{Chart's Mtg Height})^2}{(\text{Actual Mtg Height})^2}$

**LEGEND**

- 0.5 fc
- 1 fc
- 2 fc
- 5 fc
- 10 fc



TYPE 3 - 60W  
15' MOUNTING HEIGHT



TYPE 4 - 60W  
15' MOUNTING HEIGHT



TYPE 5 - 60W  
15' MOUNTING HEIGHT



TYPE 3 - 75W  
20' MOUNTING HEIGHT



TYPE 4 - 75W  
20' MOUNTING HEIGHT



TYPE 5 - 75W  
20' MOUNTING HEIGHT



TYPE 3 - 100W  
25' MOUNTING HEIGHT



TYPE 4 - 100W  
25' MOUNTING HEIGHT



TYPE 5 - 100W  
25' MOUNTING HEIGHT



TYPE 3 - 145W  
30' MOUNTING HEIGHT



TYPE 4 - 145W  
30' MOUNTING HEIGHT



TYPE 5 - 145W  
30' MOUNTING HEIGHT



TYPE 3 - 200W  
35' MOUNTING HEIGHT



TYPE 4 - 200W  
35' MOUNTING HEIGHT



TYPE 5 - 200W  
35' MOUNTING HEIGHT



TYPE 3 - 310W  
40' MOUNTING HEIGHT



TYPE 4 - 310W  
40' MOUNTING HEIGHT



TYPE 5 - 310W  
40' MOUNTING HEIGHT