

LED SLIM AREA LIGHTS

AR SERIES

Fixture shown with Slipfitter Knuckle



60/75W Model

Fixture shown with Adjustable Wall Mount and Motion Sensor



100/145W Model

Fixture shown with Straight Arm



200/310W Model

Fixture shown with Flexible Tilt Arm and Motion Sensor



PRODUCT DESCRIPTION:

The LED Slim Area Lights deliver class-leading efficacy in a lightweight design that can be effortlessly applied to new and retrofit outdoor projects. Offered in lumen packages ranging from 7,700lm to over 40,000+lm, the AR Series achieves up to 158 lumens per watt while providing significant long-term energy and maintenance cost savings.

FEATURES:

- CCT selectable between 3000K/4000K/5000K
- Replaces up to 1,000W MH equivalent
- Universal 120-277V dimming driver standard, 277-480V available
- Controls Ready - simple plug and play Sensor Receptacle enables installation of c-Max, photocell, motion sensor/PC and future network controls without changing the fixture
- Meets ANSI 3G vibration standard for bridges and overpasses
- Comes with 41" 18/3 SO cord
- Trade Agreements Act (TAA) compliant product available - Contact MaxLite for details

MOUNTING:

- 7.5" Straight Arm¹, includes labor saving slot pattern which eliminates need to drill holes on most retrofits
- Trunnion Swivel
- 2-3/8" - 3" OD Slipfitter Knuckle
- Flexible Tilt Arm¹, includes labor saving slot pattern which eliminates need to drill holes on most retrofits
- Adjustable Wall Mount

WARRANTY:

10-year standard warranty with labor allowance* (further details available at www.maxlite.com/warranties)

*Warranty Limitations: Product must be rated for the application per the Product Data Sheet (PDS); operated ≤16 hrs/day; in ambient of -29°F to 104°F. *Up to \$25/unit; labor allowances of up to \$500/unit available for purchase – contact MaxLite representative for details.



Mounting Arms include labor saving slot pattern

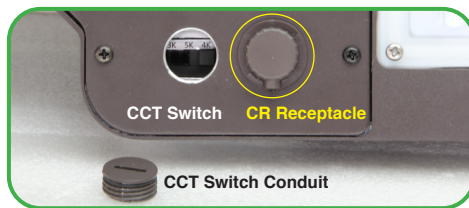





MODEL SELECTION		Typical order example: AR60UT5-50BK						
AR								
FAMILY	NOMINAL WATTAGE	VOLTAGE	DISTRIBUTION		CCT	FINISH	MOUNTING	OPTIONS
AR= Area Light	60= 60W, 250W MH/HPS equivalent 75= 75W, 300W MH/HPS equivalent 100= 100W, 400W MH/HPS equivalent 145= 145W, 400W MH/HPS equivalent 200= 200W, 750W MH/HPS equivalent 310= 310W, 1,000W MH/HPS equivalent	U= 120-277V H= 277-480V	T3= Type III T4= Type IV T5= Type V	-	CS= CCT Selectable (3/4/5K)	B= Bronze <i>Contact MaxLite for additional finishes</i>	A= Straight Arm ¹ K= 2-3/8" -3" OD Slipfitter Knuckle T= Trunnion Swivel F= Flexible (Adjustable) Arm ¹ W= Adjustable Wall Mount	CR= Controls Ready (Order field installable c-Max control node separately) RPC= NEMA 3-pin receptacle (NEMA twist lock Photocell sold separately) PR7= NEMA 7-Pin receptacle (control module sold separately)

NOTE:

¹ Arm Mounts fit square poles, for round poles add a round pole adapter - see Accessories table.

DLC PREMIUM LISTINGS

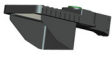
MODEL #	DLC ID #	MODEL #	DLC ID #	MODEL #	DLC ID #
AR60, T3	PC7U5Q3R	AR100, T3	PMR1F0BT	AR200, T3	P72VJ33N
AR60, T4	PM79R3OT	AR100, T4	PUCKC89T	AR200, T4	PIRHLN0X
AR60, T5	P3LDQEBP	AR100, T5	P4W71WQ2	AR200, T5	P9H4BZS6
AR75, T3	PN6EBZ0Q	AR145, T3	PG46WKYG	AR310, T3	POWODT95
AR75, T4	PFU2GBWZ	AR145, T4	PJ32ZMFD	AR310, T4	PXBCH4XH
AR75, T5	PV1RC991	AR145, T5	PDCHQFHI	AR310, T5	PYRAGHCJ

ACCESSORIES			
MODEL #	ORDER CODE	DESCRIPTION	IMAGE
RPA3-B	106239	3" ROUND POLE ADAPTER, SLOTTED DRILL PATTERN, BRONZE	
RPA4-B	106240	4" ROUND POLE ADAPTER, SLOTTED DRILL PATTERN, BRONZE	
RPA5-B	106241	5" ROUND POLE ADAPTER, SLOTTED DRILL PATTERN, BRONZE	
CN-RDPCB†	105569	C-MAX PHOTOCELL NODE ROUND, BRONZE, IP66, USED WITH CONTROLS READY FIXTURES	
CN-RDMSB†*	105566	C-MAX CONTROL NODE ROUND, PIR MOTION SENSOR/PHOTOCELL, BRONZE, IP66, USED WITH CONTROLS READY FIXTURES	
CN-REMOTE	105567	C-MAX REMOTE CONTROL, AT LEAST 1 PER PROJECT TO PROGRAM MOTION SENSOR (CN-RDMSB)	
AR-S-HS-GEN2-B	103658	HOUSE SIDE SHIELD FOR AR GEN 2 SERIES, BRONZE FINISH, FITS 60W/75W/100W/145W	
AR-MAL-L-HS-B	1408946	HOUSE SIDE SHIELD, BRONZE FINISH, FITS 200/310W	
PCTL-UNV	105038	TWIST-LOCK ELECTRONIC PHOTOCONTROL 120/208/240/277V (USED WITH RPC OPTION, NOT C-MAX)	
PCTL-HV	105866	TWIST-LOCK ELECTRONIC PHOTOCONTROL 480V (USED WITH RPC OPTION, NOT C-MAX)	
MLRTLPCRSP	96268	SHORTING CAP FOR NEMA TWIST LOCK PHOTOCELL RECEPTACLE (3, 5 OR 7 PIN)	

† Requires 1.5M Allen wrench

* Requires at least 1 remote control (CN-REMOTE) per project to program

SPECIFICATIONS		AR60	AR75	AR100	AR145	AR200	AR310
SPECIFICATION		DETAILS					
Nominal Wattage (W)		60	75	100	145	200	310
CCT		Selectable between 3000K, 4000K or 5000K					
CRI		≥70					
Lumens Type III		8,050-8,800	9,950-10,900	13,500-14,780	19,170-20,950	27,600-30,190	40,350-44,100
BUG Rating	3K	B1-U0-G2	B2-U0-G2	B2-U0-G2	B3-U0-G3	B3-U0-G3	B3-U0-G4
	4K	B2-U0-G2	B2-U0-G2	B2-U0-G3	B3-U0-G3	B3-U0-G4	B4-U0-G4
	5K	B1-U0-G2	B2-U0-G2	B2-U0-G3	B3-U0-G3	B3-U0-G3	B3-U0-G4
Lumens Type IV		7,900-8,650	9,790-10,700	13,270-14,500	18,800-20,550	27,100-29,650	39,600-43,350
BUG Rating	3K	B1-U0-G2	B1-U0-G2	B2-U0-G3	B2-U0-G3	B3-U0-G4	B3-U0-G5
	4K	B1-U0-G2	B2-U0-G2	B2-U0-G3	B3-U0-G3	B3-U0-G5	B3-U0-G5
	5K	B1-U0-G2	B1-U0-G2	B2-U0-G3	B2-U0-G3	B3-U0-G5	B3-U0-G5
Lumens Type V		8,190-8,950	10,140-11,050	13,750-15,050	19,500-21,340	28,100-30,730	41,090-44,940
BUG Rating	3K	B3-U0-G1	B3-U0-G2	B4-U0-G2	B4-U0-G2	B5-U0-G3	B5-U0-G4
	4K	B3-U0-G2	B3-U0-G2	B4-U0-G2	B4-U0-G2	B5-U0-G3	B5-U0-G4
	5K	B3-U0-G1	B3-U0-G2	B4-U0-G2	B4-U0-G2	B5-U0-G3	B5-U0-G4
Efficacy (lm/W)		126-149	130-154	130-153	130-154	134-158	133-157
Dimming		0-10V and High-end trim					
Power Factor		≥0.90					
Input Voltage		120-277V, 277-480V option					
Surge Protection		Standard: 120-277V 10kV, 277-480V 20kA; Special order for 120-277V 20kA					
Housing		Die Cast Aluminum with corrosion resistant powder coat finish					
Lens		Impact resistant, UV stabilized Polycarbonate					
Mounting		Die Cast Aluminum: Straight and Flexible Arm, Slip Fitter, Trunnion or Adjustable Wall					
EPA (sq ft) 0°/90°		0.43/1.34		0.43/1.64		0.49/2.26	
Operating Temperature		-40°F to 104°F (-40°C to 40°C)					
Listings		FCC, cULus, RoHS, T24 Compliant, ANSI 3G Vibration (Bridges and Overpasses)					
Environment		IP65, WL					
Warranty		10 Years					

DIMENSIONS:



60/75W Model



100/145W Model



200/310W Model

MOUNTING:

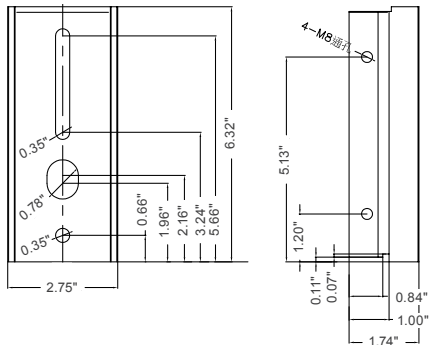

Round Pole Adapter (RPA) 3"

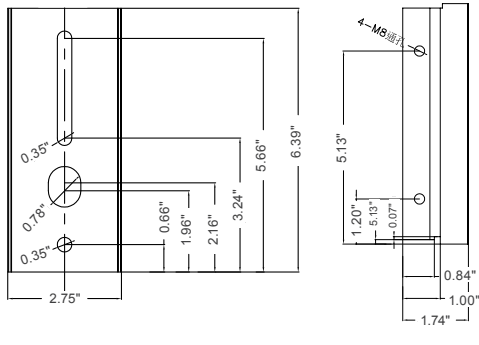
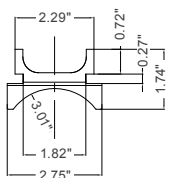

Round Pole Adapter (RPA) 4"

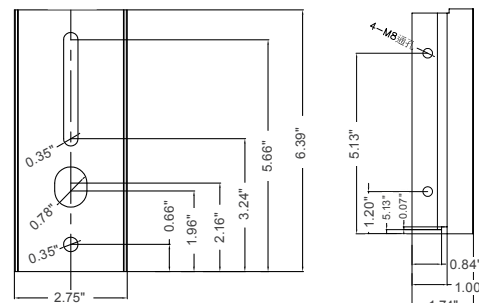
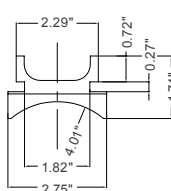

Round Pole Adapter (RPA) 5"

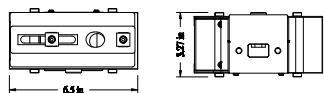
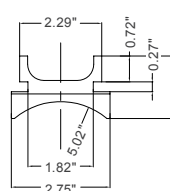

Adjustable Square Arm

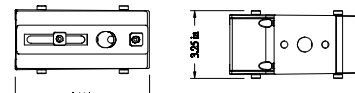
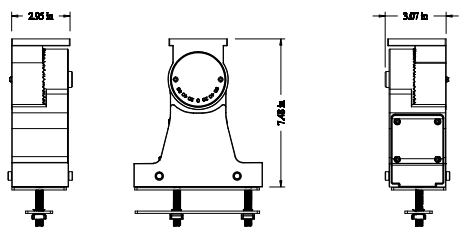

Fixed Square Arm

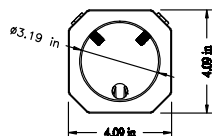
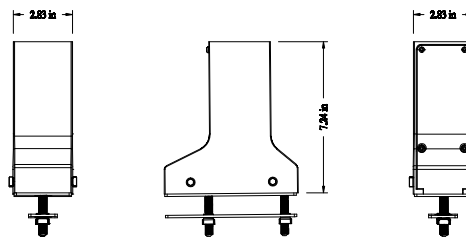

Slipfitter Arm (fits 2 3/8"-3" OD)

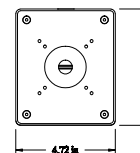
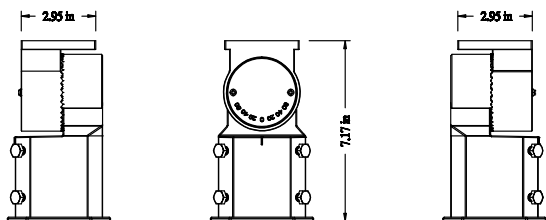

Adjustable Wall Mount

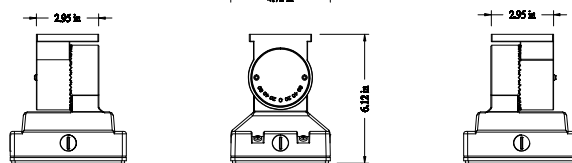

ISOFOOTCANDLE:

Each gridline represents one mounting height.

For mounting heights other than noted multiply FC by the below factor.

Factor = $\frac{(\text{Chart's Mtg Height})^2}{(\text{Actual Mtg Height})^2}$

LEGEND

- 0.5 fc
- 1 fc
- 2 fc
- 5 fc
- 10 fc



TYPE 3 - 60W
15' MOUNTING HEIGHT



TYPE 4 - 60W
15' MOUNTING HEIGHT

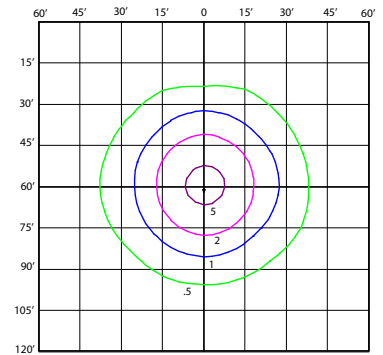

TYPE 5 - 60W
15' MOUNTING HEIGHT



TYPE 3 - 75W
20' MOUNTING HEIGHT



TYPE 4 - 75W
20' MOUNTING HEIGHT

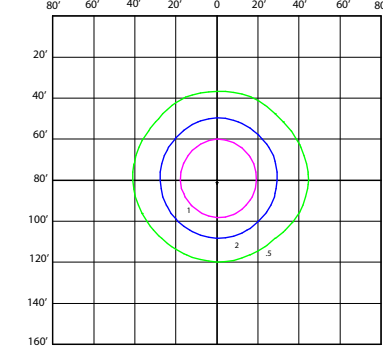

TYPE 5 - 75W
20' MOUNTING HEIGHT



TYPE 3 - 100W
25' MOUNTING HEIGHT



TYPE 4 - 100W
25' MOUNTING HEIGHT

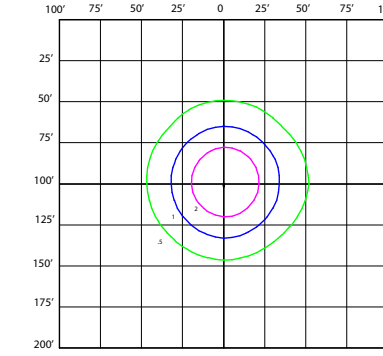

TYPE 5 - 100W
25' MOUNTING HEIGHT



TYPE 3 - 145W
30' MOUNTING HEIGHT



TYPE 4 - 145W
30' MOUNTING HEIGHT



TYPE 5 - 145W
30' MOUNTING HEIGHT

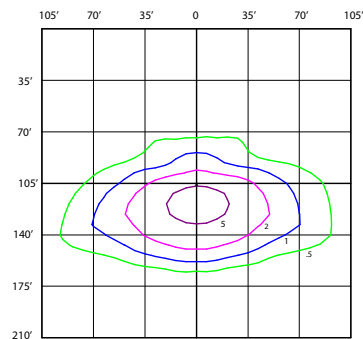

TYPE 3 - 200W
35' MOUNTING HEIGHT

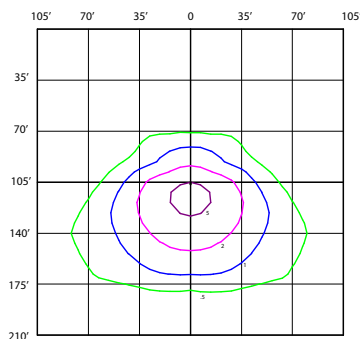

TYPE 4 - 200W
35' MOUNTING HEIGHT

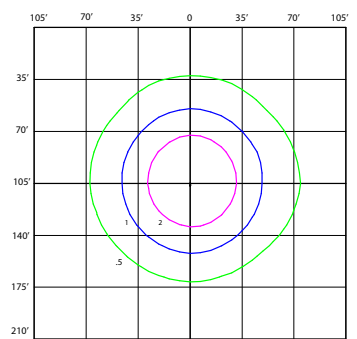

TYPE 5 - 200W
35' MOUNTING HEIGHT



TYPE 3 - 310W
40' MOUNTING HEIGHT



TYPE 4 - 310W
40' MOUNTING HEIGHT

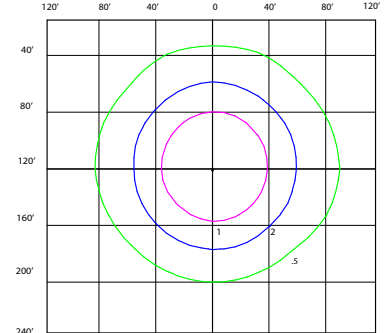

TYPE 5 - 310W
40' MOUNTING HEIGHT