

## LED SLIM AREA LIGHTS

### AR SERIES

Fixture shown with Slipfitter Knuckle



60/75W Model

Fixture shown with Adjustable Wall Mount and Motion Sensor



100/145W Model

Fixture shown with Straight Arm



200/310W Model

Fixture shown with Flexible Tilt Arm and Motion Sensor



Mounting Arms include labor saving slot pattern



### PRODUCT DESCRIPTION:

The LED Slim Area Lights deliver class-leading efficacy in a lightweight design that can be effortlessly applied to new and retrofit outdoor projects. Offered in lumen packages ranging from 7,700lm to over 40,000+lm, the AR Series achieves up to 158 lumens per watt while providing significant long-term energy and maintenance cost savings.

### FEATURES:

- CCT selectable between 3000K/4000K/5000K
- Replaces up to 1,000W MH equivalent
- Universal 120-277V dimming driver standard, 277-480V available
- Controls Ready - simple plug and play Sensor Receptacle enables installation of c-Max, photocell, motion sensor/PC and future network controls without changing the fixture
- Meets ANSI 3G vibration standard for bridges and overpasses
- Comes with 41" 18/3 SO cord
- Trade Agreements Act (TAA) compliant product available - Contact MaxLite for details

### MOUNTING:

- 7.5" Straight Arm<sup>1</sup>, includes labor saving slot pattern which eliminates need to drill holes on most retrofits
- Trunnion Swivel
- 2-3/8" - 3" OD Slipfitter Knuckle
- Flexible Tilt Arm<sup>1</sup>, includes labor saving slot pattern which eliminates need to drill holes on most retrofits
- Adjustable Wall Mount

### WARRANTY:

10-year standard warranty with labor allowance\* (further details available at [www.maxlite.com/warranties](http://www.maxlite.com/warranties))

\*Warranty Limitations: Product must be rated for the application per the Product Data Sheet (PDS); operated ≤16 hrs/day; in ambient of -29°F to 104°F. \*Up to \$25/unit; labor allowances of up to \$500/unit available for purchase – contact MaxLite representative for details.







MODEL SELECTION		Typical order example: AR60UT5-50BK						
AR								
FAMILY	NOMINAL WATTAGE	VOLTAGE	DISTRIBUTION		CCT	FINISH	MOUNTING	OPTIONS
AR= Area Light	<b>60=</b> 60W, 250W MH/HPS equivalent <b>75=</b> 75W, 300W MH/HPS equivalent <b>100=</b> 100W, 400W MH/HPS equivalent <b>145=</b> 145W, 400W MH/HPS equivalent <b>200=</b> 200W, 750W MH/HPS equivalent <b>310=</b> 310W, 1,000W MH/HPS equivalent	<b>U=</b> 120-277V <b>H=</b> 277-480V	<b>T3=</b> Type III <b>T4=</b> Type IV <b>T5=</b> Type V	-	<b>CS=</b> CCT Selectable (3/4/5K)	<b>B=</b> Bronze  <i>Contact MaxLite for additional finishes</i>	<b>A=</b> Straight Arm <sup>1</sup> <b>K=</b> 2-3/8" -3" OD Slipfitter Knuckle <b>T=</b> Trunnion Swivel <b>F=</b> Flexible (Adjustable) Arm <sup>1</sup> <b>W=</b> Adjustable Wall Mount	<b>CR=</b> Controls Ready (Order field installable c-Max control node separately)  <b>RPC=</b> NEMA 3-pin receptacle (NEMA twist lock Photocell sold separately)  <b>PR7=</b> NEMA 7-Pin receptacle (control module sold separately)

#### NOTE:

<sup>1</sup> Arm Mounts fit square poles, for round poles add a round pole adapter - see Accessories table.

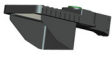
**DLC PREMIUM LISTINGS**

MODEL #	DLC ID #	MODEL #	DLC ID #	MODEL #	DLC ID #
AR60, T3	PC7U5Q3R	AR100, T3	PMR1F0BT	AR200, T3	P72VJ33N
AR60, T4	PM79R3OT	AR100, T4	PUCKC89T	AR200, T4	PIRHLN0X
AR60, T5	P3LDQEBP	AR100, T5	P4W71WQ2	AR200, T5	P9H4BZS6
AR75, T3	PN6EBZ0Q	AR145, T3	PG46WKYG	AR310, T3	POWODT95
AR75, T4	PFU2GBWZ	AR145, T4	PJ32ZMFD	AR310, T4	PXBCH4XH
AR75, T5	PV1RC991	AR145, T5	PDCHQFHI	AR310, T5	PYRAGHCJ

ACCESSORIES			
MODEL #	ORDER CODE	DESCRIPTION	IMAGE
RPA3-B	106239	3" ROUND POLE ADAPTER, SLOTTED DRILL PATTERN, BRONZE	
RPA4-B	106240	4" ROUND POLE ADAPTER, SLOTTED DRILL PATTERN, BRONZE	
RPA5-B	106241	5" ROUND POLE ADAPTER, SLOTTED DRILL PATTERN, BRONZE	
CN-RDPCB†	105569	C-MAX PHOTOCELL NODE ROUND, BRONZE, IP66, USED WITH CONTROLS READY FIXTURES	
CN-RDMSB†*	105566	C-MAX CONTROL NODE ROUND, PIR MOTION SENSOR/PHOTOCELL, BRONZE, IP66, USED WITH CONTROLS READY FIXTURES	
CN-REMOTE	105567	C-MAX REMOTE CONTROL, AT LEAST 1 PER PROJECT TO PROGRAM MOTION SENSOR (CN-RDMSB)	
AR-S-HS-GEN2-B	103658	HOUSE SIDE SHIELD FOR AR GEN 2 SERIES, BRONZE FINISH, FITS 60W/75W/100W/145W	
AR-MAL-L-HS-B	1408946	HOUSE SIDE SHIELD, BRONZE FINISH, FITS 200/310W	
PCTL-UNV	105038	TWIST-LOCK ELECTRONIC PHOTOCONTROL 120/208/240/277V (USED WITH RPC OPTION, NOT C-MAX)	
PCTL-HV	105866	TWIST-LOCK ELECTRONIC PHOTOCONTROL 480V (USED WITH RPC OPTION, NOT C-MAX)	
MLRTLPCRSP	96268	SHORTING CAP FOR NEMA TWIST LOCK PHOTOCELL RECEPTACLE (3, 5 OR 7 PIN)	

† Requires 1.5M Allen wrench

\* Requires at least 1 remote control (CN-REMOTE) per project to program

SPECIFICATIONS		AR60	AR75	AR100	AR145	AR200	AR310
<b>SPECIFICATION</b>		<b>DETAILS</b>					
Nominal Wattage (W)		60	75	100	145	200	310
CCT		Selectable between 3000K, 4000K or 5000K					
CRI		≥70					
Lumens Type III		8,050-8,800	9,950-10,900	13,500-14,780	19,170-20,950	27,600-30,190	40,350-44,100
BUG Rating	3K	B1-U0-G2	B2-U0-G2	B2-U0-G2	B3-U0-G3	B3-U0-G3	B3-U0-G4
	4K	B2-U0-G2	B2-U0-G2	B2-U0-G3	B3-U0-G3	B3-U0-G4	B4-U0-G4
	5K	B1-U0-G2	B2-U0-G2	B2-U0-G3	B3-U0-G3	B3-U0-G3	B3-U0-G4
Lumens Type IV		7,900-8,650	9,790-10,700	13,270-14,500	18,800-20,550	27,100-29,650	39,600-43,350
BUG Rating	3K	B1-U0-G2	B1-U0-G2	B2-U0-G3	B2-U0-G3	B3-U0-G4	B3-U0-G5
	4K	B1-U0-G2	B2-U0-G2	B2-U0-G3	B3-U0-G3	B3-U0-G5	B3-U0-G5
	5K	B1-U0-G2	B1-U0-G2	B2-U0-G3	B2-U0-G3	B3-U0-G5	B3-U0-G5
Lumens Type V		8,190-8,950	10,140-11,050	13,750-15,050	19,500-21,340	28,100-30,730	41,090-44,940
BUG Rating	3K	B3-U0-G1	B3-U0-G2	B4-U0-G2	B4-U0-G2	B5-U0-G3	B5-U0-G4
	4K	B3-U0-G2	B3-U0-G2	B4-U0-G2	B4-U0-G2	B5-U0-G3	B5-U0-G4
	5K	B3-U0-G1	B3-U0-G2	B4-U0-G2	B4-U0-G2	B5-U0-G3	B5-U0-G4
Efficacy (lm/W)		126-149	130-154	130-153	130-154	134-158	133-157
Dimming		0-10V and High-end trim					
Power Factor		≥0.90					
Input Voltage		120-277V, 277-480V option					
Surge Protection		Standard: 120-277V 10kV, 277-480V 20kA; Special order for 120-277V 20kA					
Housing		Die Cast Aluminum with corrosion resistant powder coat finish					
Lens		Impact resistant, UV stabilized Polycarbonate					
Mounting		Die Cast Aluminum: Straight and Flexible Arm, Slip Fitter, Trunnion or Adjustable Wall					
EPA (sq ft) 0°/90°		0.43/1.34		0.43/1.64		0.49/2.26	
Operating Temperature		-40°F to 104°F (-40°C to 40°C)					
Listings		FCC, cULus, RoHS, T24 Compliant, ANSI 3G Vibration (Bridges and Overpasses)					
Environment		IP65, WL					
Warranty		10 Years					

**DIMENSIONS:**



60/75W Model



100/145W Model

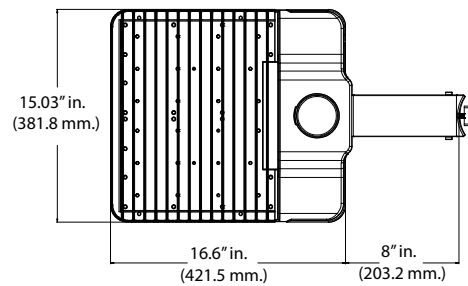

200/310W Model

**MOUNTING:**

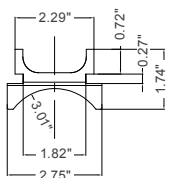
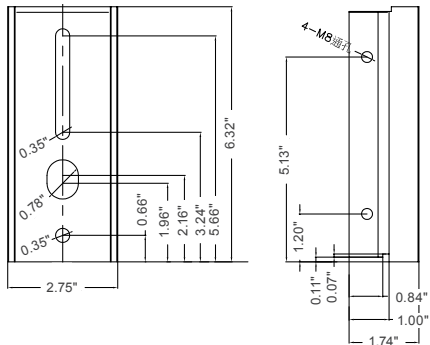

Round Pole Adapter (RPA) 3"

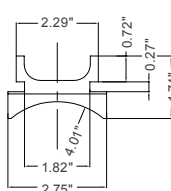
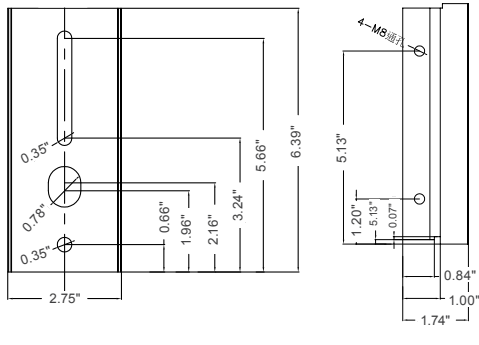

Round Pole Adapter (RPA) 4"

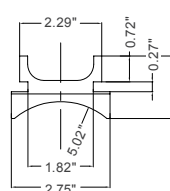
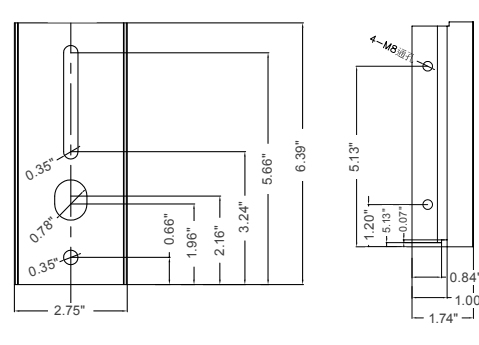

Round Pole Adapter (RPA) 5"

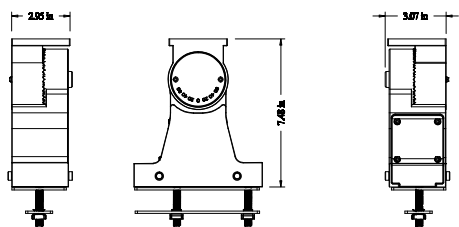
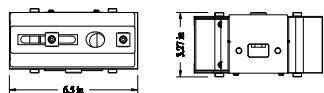

Adjustable Square Arm

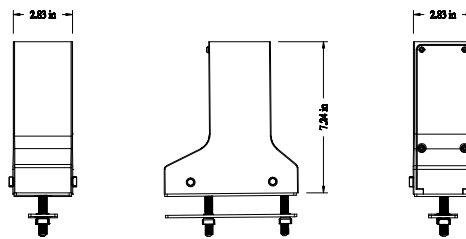
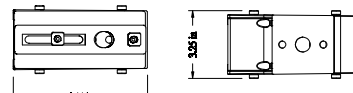

Fixed Square Arm

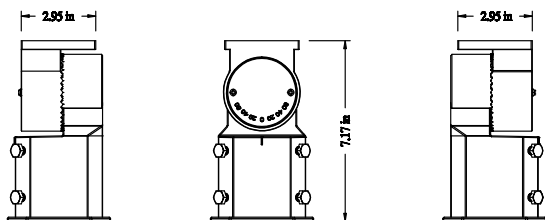
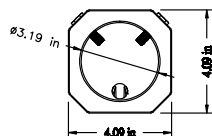

Slipfitter Arm (fits 2 3/8"-3" OD)

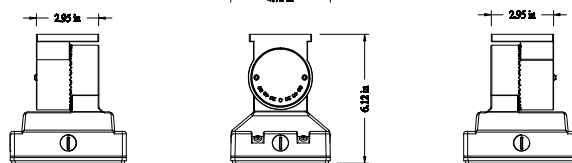
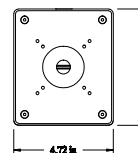

Adjustable Wall Mount

**ISOFOOTCANDLE:**

Each gridline represents one mounting height.

For mounting heights other than noted multiply FC by the below factor.

$$\text{Factor} = \frac{(\text{Chart's Mtg Height})^2}{(\text{Actual Mtg Height})^2}$$

**LEGEND**

- 0.5 fc
- 1 fc
- 2 fc
- 5 fc
- 10 fc

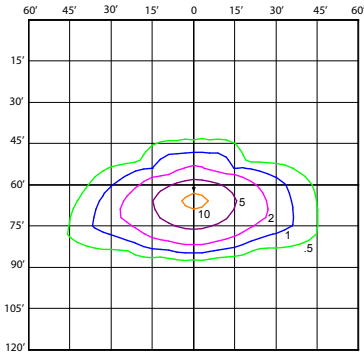

TYPE 3 - 60W  
15' MOUNTING HEIGHT

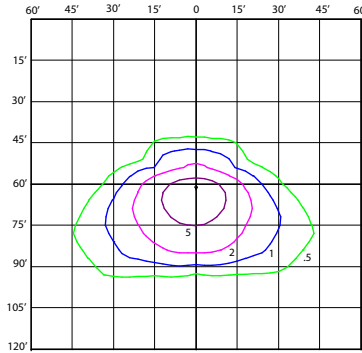

TYPE 4 - 60W  
15' MOUNTING HEIGHT

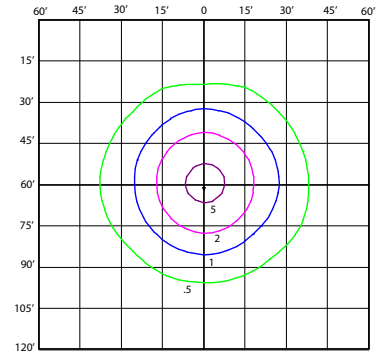

TYPE 5 - 60W  
15' MOUNTING HEIGHT



TYPE 3 - 75W  
20' MOUNTING HEIGHT



TYPE 4 - 75W  
20' MOUNTING HEIGHT

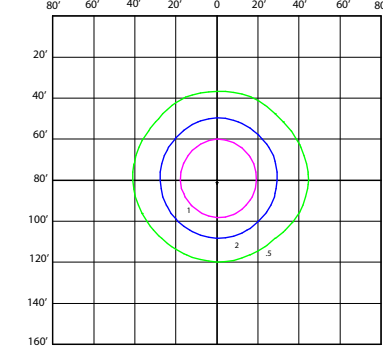

TYPE 5 - 75W  
20' MOUNTING HEIGHT



TYPE 3 - 100W  
25' MOUNTING HEIGHT



TYPE 4 - 100W  
25' MOUNTING HEIGHT

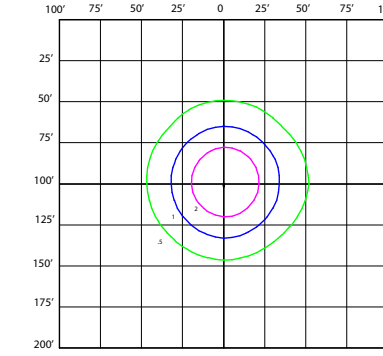

TYPE 5 - 100W  
25' MOUNTING HEIGHT



TYPE 3 - 145W  
30' MOUNTING HEIGHT



TYPE 4 - 145W  
30' MOUNTING HEIGHT



TYPE 5 - 145W  
30' MOUNTING HEIGHT

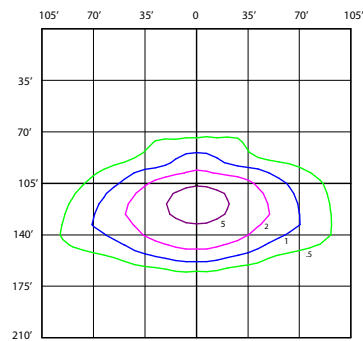

TYPE 3 - 200W  
35' MOUNTING HEIGHT

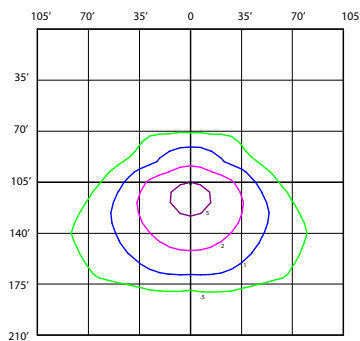

TYPE 4 - 200W  
35' MOUNTING HEIGHT

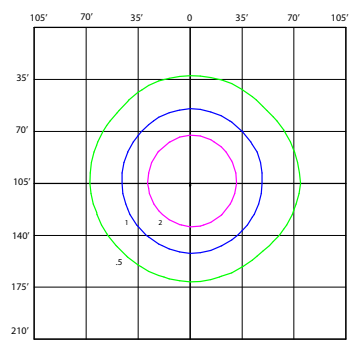

TYPE 5 - 200W  
35' MOUNTING HEIGHT



TYPE 3 - 310W  
40' MOUNTING HEIGHT



TYPE 4 - 310W  
40' MOUNTING HEIGHT

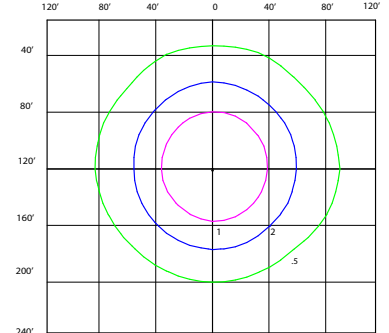

TYPE 5 - 310W  
40' MOUNTING HEIGHT