

LED SLIM AREA LIGHTS AR-MAL SERIES



Fixtures shown with Slipfitter Knuckle



280W Model



60-140W Model

DIMENSIONS: Please see Page 3 and 4 for dimension drawings.

PRODUCT DESCRIPTION:

Say goodbye to the clunky shoebox. The LED Slim Area Lights (AR-MAL) delivers class-leading efficacy in a lightweight design that can be effortlessly applied to new and retrofit outdoor projects. Offered in lumen packages ranging from 7,700lm to over 30,000lm watts, the AR-MAL Series achieves up to 129 lumens per watt while providing significant long-term energy and maintenance cost savings.

FEATURES:

- Replaces up to 1000W MH equivalent
- Type III and Type V optics available
- Universal 120-277V dimming driver standard, 347-480V available
- Dusk-to-dawn and occupancy sensor compatible
- Greater than 50,000 hour L70 lifetime at TM21 standards at 25°C
- 5-year limited warranty

MOUNTING:

- 6" Extruded Straight Arm**
- Trunnion Swivel
- 2-3/8" Slipfitter Knuckle
- All mounting options sold separately

CONTROLS:

Motion/Daylight Sensor: Passive infrared (PIR) sensing technology that reacts to changes in infrared energy (i.e. moving body heat) within the coverage area. This slim, low-profile sensor is designed for installation inside the bottom of a light fixture body and is ideal for outdoor environments. The sensor operates at 120V/230V-240V and single phase 277V. The IP66 rated motion sensor is fully adjustable with high and low dimmed light level options and mounting heights from 8' to 40'.

Please refer to the MS4 Supplementary Datasheet for more product information.

MODEL SELECTION		Typical order example: AR-MAL60UT350-BR					
AR-MAL				-			
FAMILY	NOMINAL WATTAGE	VOLTAGE	DISTRIBUTION	-	CCT	FINISH	CONTROLS
AR-MAL Medium = Area Light	60= 60W, 150W PSMH equivalent 100= 100W, 250W PSMH equivalent 140= 140W, 400W PSMH equivalent 280= 280W, 750W PSMH equivalent	U= 120-277V H= 347-480V	T3= Type III T5= Type V	-	40= *4000K 50= 5000K	BR= Bronze **BL= Black **WH= White	(OMIT)= None MS1= Daylight/Motion Sensor RPC= NEMA 3-pin photocontrol options

MOUNTING SELECTION		Typical order example: AR-MALSK-BR	
AR-MAL		-	
FAMILY	ARM	-	FINISH
AR-MAL = Medium Area Light	***SA= Straight Arm SK= Slipfitter Knuckle TS= Trunnion Swivel		BR= Bronze **BL= Black **WH= White

NOTES:

*4000K is currently unavailable with 280W Models.
 **Black and white finish are special order. Contact MaxLite representative for quantities and lead times.
 ***The straight arm mounting fits square poles. For compatibility with round poles, combine the straight arm mounting with a round pole adaptor. See adaptor selection table on next page.

ROUND POLE ADAPTORS**:**

ORDER CODE	MODEL	DESCRIPTION
107846	AR-MAL-4RPA	4" Round Pole Adaptor for AR-MAL Series, to be used with straight arm
107847	AR-MAL-5RPA	5" Round Pole Adaptor for AR-MAL Series, to be used with straight arm

****Must be used with straight arm mounting

SPECIFICATIONS:

		AR-MAL60	AR-MAL100	AR-MAL140	AR-MAL280
ITEM	SPECIFICATION	DETAILS			
GENERAL PERFORMANCE	Input Power (W)	61	96	135	273
	Lumens Delivered (lm) - 4000K	7,825	12,530	17,135	Not Offered
	Efficacy (lm/W) - 4000K	129	130	127	Not Offered
	Lumens Delivered (lm) - 5000K	7,725	12,360	17,120	31,015
	Efficacy (lm/W) - 5000K	129	129	126	114
	CRI	≥75			
	Lumen Maintenance (L70, TM-21 @ 25°C)	≥50,000			
	Color Temperature	5000K standard, 4000K available			
	Spacing Criteria	Available Upon Request			
	Color Consistency	Proprietary binning for uniform color			
ELECTRICAL	Power Factor (120/277V)	>0.99/>0.89			
	Input Voltage	120-277V standard, 347-480V available			
PHYSICAL	Housing	Die-cast aluminium			
	Lens	Type III, Type V - Frosted lens			
	Mounting	Slip Fitter, Straight Arm, Trunnion Mount options			
	Dimensions	22.48" L x 12.28" W x 3.22" H			24.6" L x 15.28" W 3.48" H
	Weight	16.1 lbs	16.3 lbs	17.0 lbs	24.8 lbs
	EPA (sq. ft)	0.43	0.43	0.43	0.49
	Operating Temperature	-35°C to 55°C			
	Humidity	100%			
QUALIFICATIONS	Qualifications	*DLC Premium, cULus, LM-79, T24 compliant			
	Material Usage	RoHS compliant; no mercury			
	Environment	Outdoor, Wet location			
	Warranty	5 years			

*Type V optic is DLC pending. 280W models are DLC pending

ORDERING:

ORDER CODE	MODEL	FINISH	VOLTAGE	DISTRIBUTION	NOMINAL WATTAGE	CCT
103544	AR-MAL60UT3-50BR	BRONZE	120-277	TYPE III	60	5000K
107412	AR-MAL60UT5-50BR	BRONZE	120-277	TYPE V	60	5000K
103553	AR-MAL100UT3-50BR	BRONZE	120-277	TYPE III	100	5000K
107421	AR-MAL100UT5-50BR	BRONZE	120-277	TYPE V	100	5000K
103562	AR-MAL140UT3-50BR	BRONZE	120-277	TYPE III	140	5000K
107430	AR-MAL140UT5-50BR	BRONZE	120-277	TYPE V	140	5000K
103571	AR-MAL280UT3-50BR	BRONZE	120-277	TYPE III	280	5000K
107439	AR-MAL280UT5-50BR	BRONZE	120-277	TYPE V	280	5000K

*Please contact your MaxLite representative to order products that don't have order codes listed here.

DIMENSIONS:

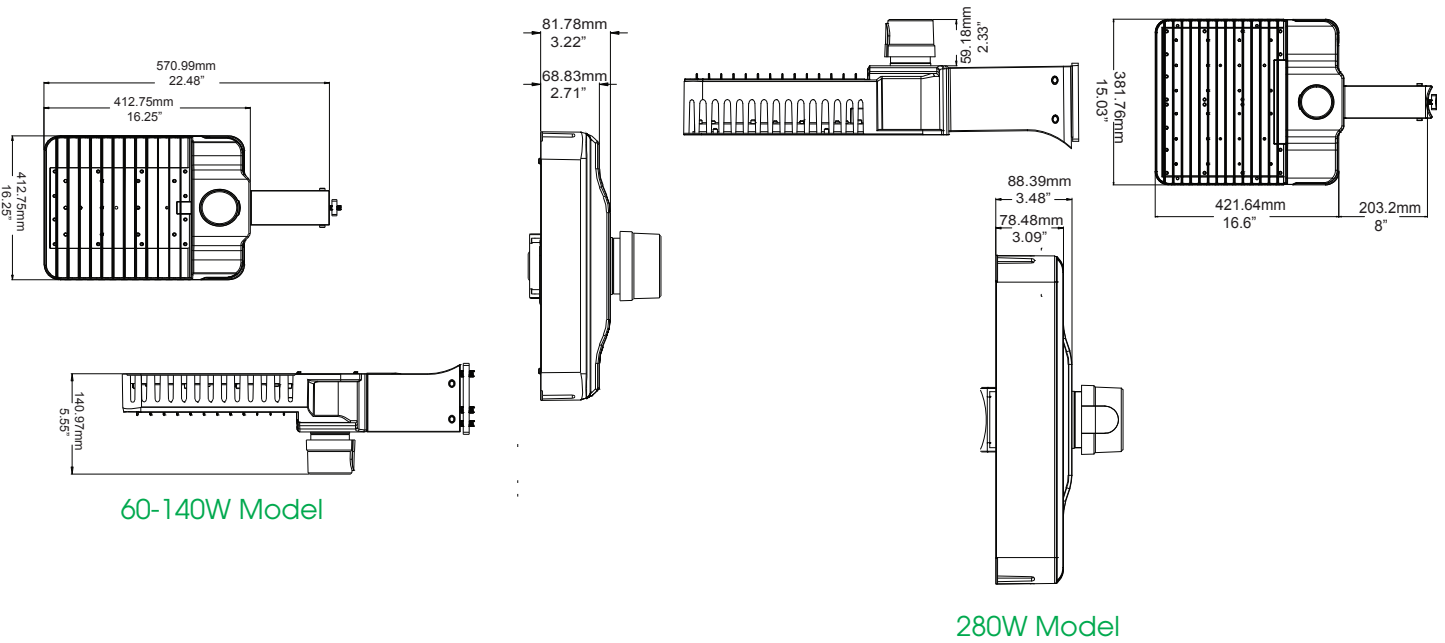

DIMENSIONS:

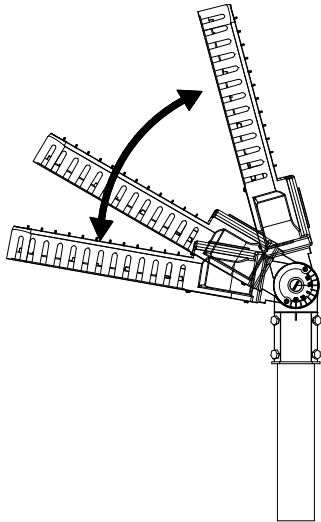

Slip Fitter

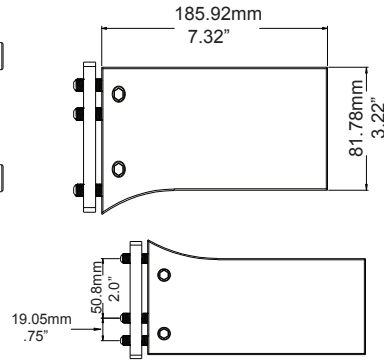
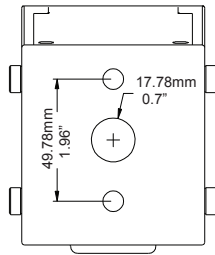

Straight Arm Pole

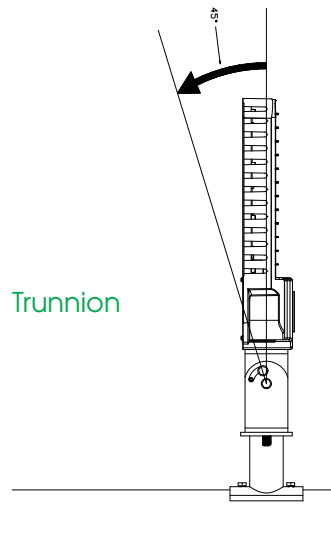

Trunnion