

AluDisc™ Magnetic Series

User Guide

Notes:

1. AluDisc™ mini, AluDisc™ Go and AluDisc™ Pro are only compatible with bare iPhone 12 and later models, Apple or Apple MFM Certified Case with MagSafe.
2. MagSafe Charger (not included) is sold by Apple and Apple authorized resellers.
3. MagSafe Charger is only compatible with bare iPhone 12 and later models, Apple or Apple MFM Certified Case with MagSafe.
4. When using the MagSafe Charger, be sure to install the MagSafe ring first. (included with AluDisc™ mini, AluDisc™ Go and AluDisc™ Pro)
5. For tablets, install the metal pad on the outside of the case. If installed on the inside, the magnetic attraction will be weaker.



Scan the QR code to view the installation video

402030430204

MagSafe Ring

For MagSafe Charger (not included)



- 1 Clean the back surface of MagSafe Charger with the wet wipe.

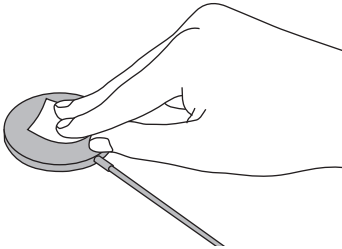

- 2 Remove the liner to reveal the adhesive.



- 3 Place the MagSafe ring on the back of MagSafe Charger. Press evenly and wait for 24 hours before use.

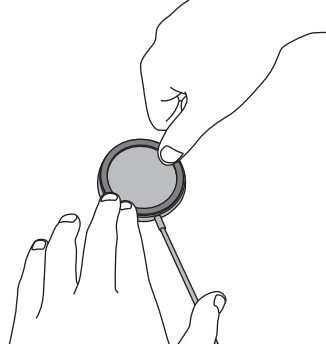

- 4 Attach the MagSafe Charger on the AluDisc™ mini, AluDisc™ Go or AluDisc™ Pro. Install complete.

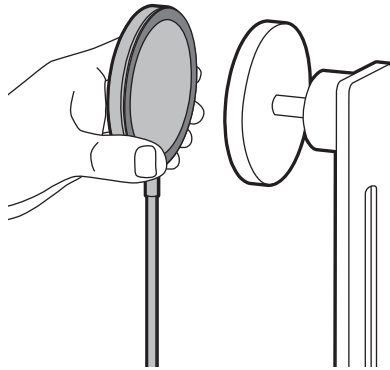

Metal Pad

For tablet



- 1 Clean the surface with the wet wipe.
- 2 Remove the liner to reveal the adhesive.
- 3 Place the metal pad at the center of the back of the tablet. Press evenly and wait for 24 hours before use.
- 4 Install complete.

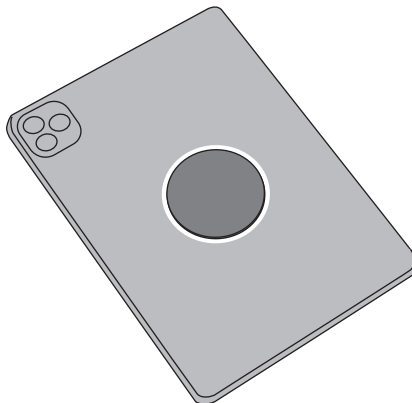

⚠ For tablets, affix the metal pad on the outside of the case. If installed on the inside, the magnetic attraction will be weaker.

AluDisc™ Pro/Max

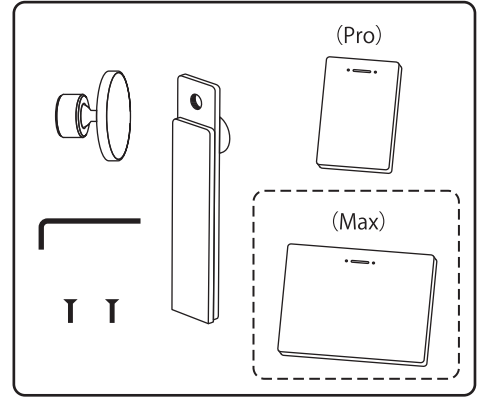

- 1 Screw in to assemble the base with the post.

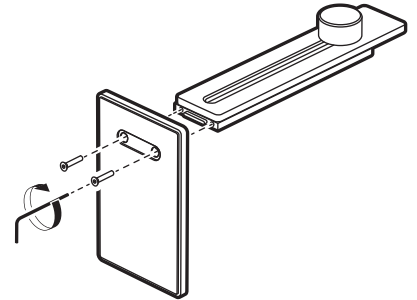

- 2 Screw on the rotating head.

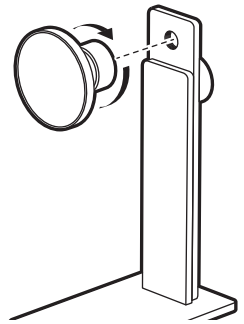

- 3 Adjust the height.

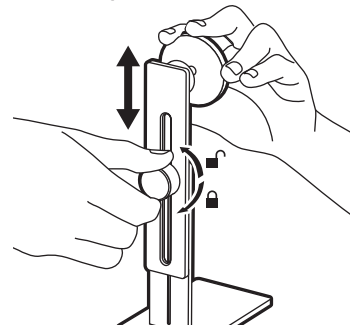

- 4 Snap on the phone/tablet.

⚠ Press/hold the base when removing.

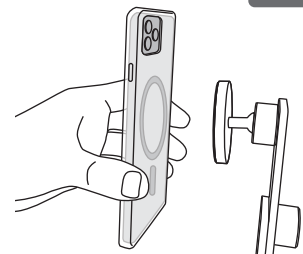

AluDisc™ Go

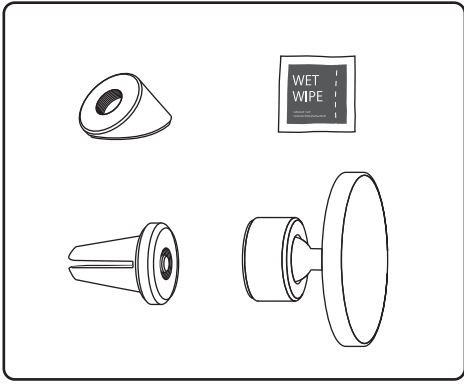

Installing the dashboard base

- 1 Identify desired mounting position on dashboard.

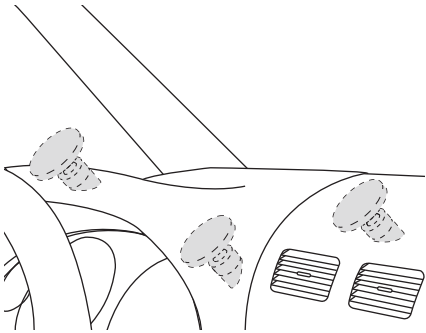

- 2 Clean the surface with the wet wipe.

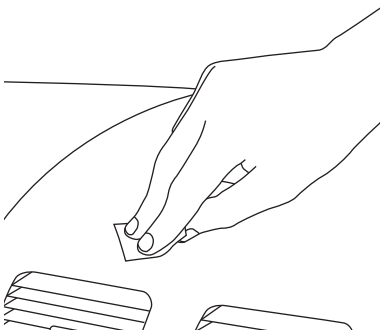

- 3 Remove the liner to reveal the adhesive.

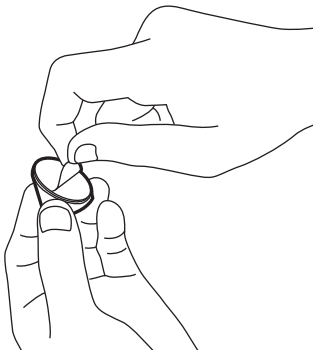

- 4 Press base FIRMLY for 5 seconds and wait for 24 hours before use.

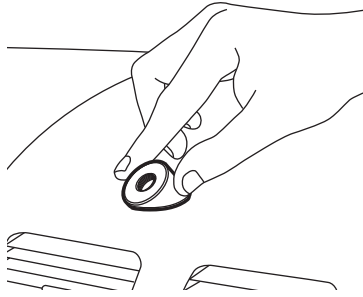

- 5 Screw on the rotating head.

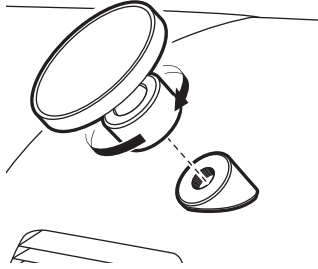

- 6 Snap on the device.

 Press/hold the dashboard base when rotating.

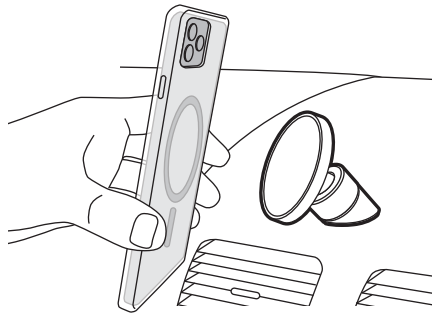

Installing the vent insert

- 1 Screw on the rotating head, and insert into vent.

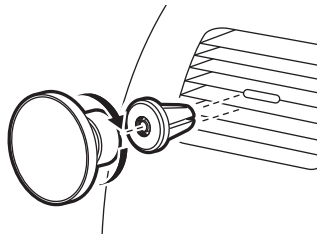

- 2 Snap on the device.

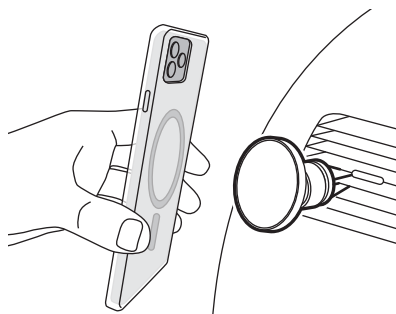

AluDisc™ mini

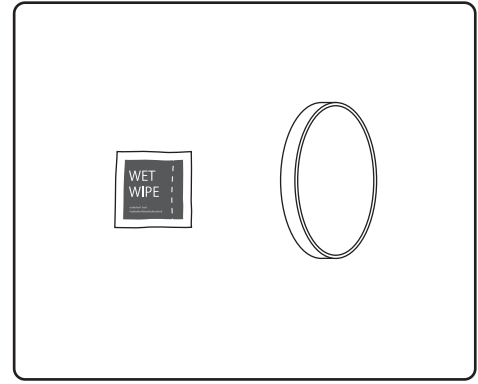

- 1 Clean the surface with the wet wipe.

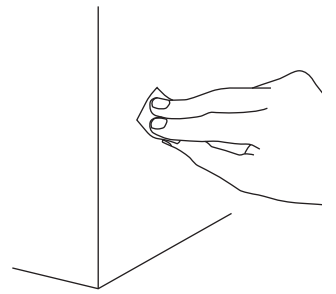

- 2 Remove the liner to reveal the adhesive.

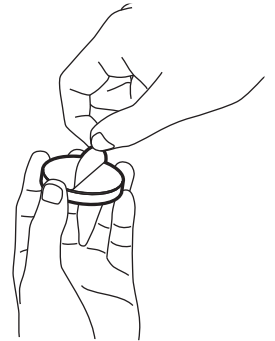

- 3 Press base FIRMLY for 5 seconds and wait for 24 hours before use.

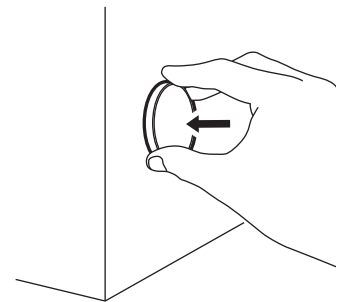

- 4 Snap on the device.

