

TRAILER & RV Parts Catalogue

Edition 3



LOAD FORCE

AUSTRALIA'S RV TRAILER SPARES

Ph: 07 3205 8846

info@trailersparesdirect.com.au

www.trailersparesdirect.com.au

TRAILER SPARES DIRECT

for trailers under 4.5 tonne

CONTENTS

About Trailer Spares Direct	4	Axles and stub axles	29-33
Couplings, plates and spares	5-7	Tips for selecting the right axle	29
Standard couplings	5	Axle rated from 1000kg to 1500kg per axle	30
Override couplings	6	Axle rated from 1800kg to 2500kg per axle	31
Off-road couplings	6	Stub axles	32
Ring couplings	7	Axle pads and nuts	33
Coupling spares	7	Assembled axles	33-34
Coupling plates and bolts	7	Bearing and multi-purpose grease	34
Handbrake levers	8	Bearing identification	34
Master cylinders and spares	9	Bearing tools	35
Hitch pins	9	Bearings	36
Coupling locks	9	Seals	37
Pintle hooks	10	Bearing protectors (buddies) and replacement caps	37
Pintle hook receivers and adapters	10	Identifying hub types	38
Tow balls and accessories	10	Lazy hubs	39
Towbar receiver hitches	11-13	Hub drum assemblies	40-41
Weight distribution systems	14	Disc hubs and rotors	42-43
Chain, shackles, chain mounts and connectors - rated	15	Disc hub identification and measurements	42
Jockey wheels	16-20	9.6 inch disc hubs	43
6 inch jockey wheels	16	10 inch disc hubs	43
8 inch jockey wheels	16	12 inch disc hubs	43
10 inch jockey wheels	18	Disc rotors - ventilated	43
EASYMOVER ratchet jockey wheels	20	Wheel studs and nuts	44
Jockey stands	21-23	Dust caps and bearing protectors	45
Top winding adjustable stands	21	Brake fluid	45
Side winding adjustable stands	22	Brake drum backing plates, brackets and spares	46-48
Over 4000kg rated side winding adjustable stands	23	9 inch hydraulic and spares	46
Adjustable legs	24-25	9 inch mechanical and spares	46
No wheel	24	10 inch electric and spares	47
With wheel	24	12 inch electric and spares	48
Quick release adjustable legs and spares	25	Mounting plates for brake drums	48
Jockey wheel, legs and stand spares	26-28	Brake shoes - LoadForce™	49
Replacement wheels	26	Brake calipers, brackets and spares	50-54
Stand and leg handles - hex head type	26	Mechanical calipers	50
Handles - slotted type	26	Hydraulic calipers	50-54
Jockey wheel handles	27	Caliper mounting brackets	54
Jockey wheel miscellaneous spares	27	Disc pads - LoadForce™	55
Clamps	28		



The American flag identifies parts commonly found on American designed trailers.

CONTENTS

HydraLine™ - flexible stainless steel braided brake line	56-60	Mudguards	82
Single axle HydraLine™ brake line kits	56	Single mudguards - metal fabricated	82
Tandem axle HydraLine™ brake line kits	57	Single mudguards - plastic	82
Tri-axle HydraLine™ brake line kits	59	Tandem mudguards	83
HydraLine™ brake hoses	60	Tri-axle mudguards	83
Associated brake hose fittings	60	Mudguard accessories	83
Brake tube and fittings	61	Mudflaps	83
Brake cables, adjusters and fittings	61	Rims	84
Brake specialist tools	61	Tyres and tubes	85
Hydrastar brake actuators	62-63	Trailer tail lights LED	86-87
Hydrastar spares	63	Maxi Lite LED tail lights	86
Wiring diagram for the Hydrastar unit	63	Narva LED tail lights	86
Batteries and breakaway	64	Trailer tail lights LED kit - Whitevision	87
IQ7 brake actuator	64	Trailer LED light boards	87
Draw bar brake controller	64	Licence plate lights	87
In-car brake controllers - proportional	65-66	Clearance lights / markers	88
Brake controller spares	66	Trailer wire	89
Brake controller installation kits	66	Battery boxes	89
Wiring diagram for the in-cab controllers	66	Reflectors	90-91
Brake kits - single, tandem and tri-axle	67-70	Load resistors	91
Spring measurements	71	Cable ties	91
Bolt-on suspension beams	72	Trailer plugs and sockets	92-95
Single (for plastic or aluminium mudguards)	72	Trailer sockets (car end)	92
Tandem	73	Trailer socket brackets (car end)	93
Eye slipper springs	74	Trailer plugs	93
Parabolic springs	74	Trailer plug adapters	94
Eye eye springs	75	Trailer socket kits (car end)	94
Spring / suspension kits	76-77	Trailer plug wiring diagram	95
Single axle slipper spring kits	76	RV lighting	96-98
Single axle shackle spring kits	76	LED tape strip lighting	96
Off-road 60mm rebound spring kits	76	Interior LED strip lamps	97
Tandem axle rocker spring kits	77	Saturn LED interior lamps	98
Tri-axle rocker spring kits	77	RV plugs, adapters and accessories	99-103
Tandem axle rocker roller spring kits	77		
Spring / suspension spares and weld-on parts	78-79		
U-bolts	80		
U-bolts for use with Jockey wheels or over chassis	81		
U-bolt spares	81		
Fish plates	81		

Contents

Marine trailer hardware	104-106
Wood yoke stems	104
Flat brackets	104
Single stem brackets	104
Twin stem brackets	104
Tandem roller brackets	104
Wobble brackets	105
Tube slide adjuster	105
Eye posts	106
Motor support	106
Winch posts	106
Tinny movers	106
Rollers	107-109
Winch post rollers	107
Keel rollers - Nylon	107
Keel rollers - Poly	108
Keel rollers - Rubber	108
Wobble rollers	109
Roller spindles	109
Skid strip, block and bunks	109
Winches	110
Marine winches	110
Brake winches	111
Winch cables, straps, hooks and spares	111
Jerry can holders	112
Spare wheel carriers	112
Gas bottle holders	112
Caravan steps	112
Tailgate hardware	113
D Shackles	113
Lanolin grease and liquid	113
Zinc sprays and anti-seize	114
Wheel chocks and holders	114
Safety equipment	114
Disclaimer, copyright and terms of sale	115

About Trailer Spares Direct

Trailer Spares Direct manufacture, import and sell the widest range of trailer spare parts for recreation and commercial trailers and RV's under 4.5 tonne. Distribution of this wide range is through wholesale, trade and direct to retail customers Australia wide. This is all backed with exceptional customer service and product knowledge.

Trailer Spares Direct is a division of Direct Source Australia Pty Ltd, a local Australian business established in 2004 with extensive experience in the brake and auto aftermarket industry. HydraLine™ and LoadForce™ are both trademarked brands owned and distributed by Trailer Spares Direct.

HydraLine™ is an innovative product developed to make the installation of hydraulic brake lines quicker and easier. The flexible stainless steel braided brake line is stamped with the name, so you know you are getting the genuine product.

Due to a large number of imported American style trailers, Trailer Spares Direct stocks a wide range of replacement American parts to save costly conversions.

Trailer Spares Direct's product range continues to expand, always based on quality and backed with helpful and friendly service. We have everything you need to get your trailer, or your customers trailer, back on the road. We offer competitive freight rates and ship orders daily throughout Australia. Pick-up and hands on service is available through our local store on the northside of Brisbane.



HYDRALINE
Flexible Stainless Steel Braided Brake Line



The American flag identifies parts commonly found on American designed trailers.

This catalogue and its contents are the copyright of Direct Source Australia Pty Ltd also trading as Trailer Spares Direct – © 2017. All rights reserved.

HydraLine™ and LoadForce™ are both trademarked brands registered and owned by Direct Source Australia Pty Ltd also trading as Trailer Spares Direct.

Couplings, plates and spares

Standard couplings

- A150-2** 50mm quick release coupling with 2 bolt holes rating 2000kg
Painted finish with anti-rattle head adjustment screw and padlock facility
Mounting hole spacing and diameter 102mm x 14mm
Ball to first centre hole 77mm
Complies with AS4177
- A150-2G** 50mm quick release coupling with 2 bolt holes rating 2000kg
Zinc plated finish with anti-rattle head adjustment screw and padlock facility
Mounting hole spacing and diameter 102mm x 14mm
Ball to first centre hole 77mm
Complies with AS4177
- A150-3** 50mm quick release coupling with 3 bolt holes rating 2000kg
Painted finish with anti-rattle head adjustment screw and padlock facility
Mounting hole spacing and diameter 110mm x 51mm x 14mm
Ball to first centre hole 67mm
Complies with AS4177
- A150-3G** 50mm quick release coupling with 3 bolt holes rating 2000kg
Zinc plated finish with anti-rattle head adjustment screw and padlock facility
Mounting hole spacing and diameter 110mm x 51mm x 14mm
Ball to first centre hole 67mm
Complies with AS4177
- A900** 50mm electric coupling with 4 bolt holes and handbrake lever rating 3500kg
Zinc plated finish with anti-rattle head adjustment screw and padlock facility
Anti-swing ratchet on a contoured handbrake lever
Mounting hole spacing and diameter 184mm x 54mm x 14mm
Complies with AS4177
- A900NL** 50mm electric coupling with 4 bolt holes and no handbrake lever
rating 3500kg
Zinc plated finish with anti-rattle head adjustment
screw and padlock facility
Mounting hole spacing and diameter 184mm x 54mm x 14mm
Complies with AS4177
- TBC70** 70mm coupling with 4 bolt holes and handbrake lever rating 4500kg
Zinc finish with anti-rattle head adjustment and padlock facility
Mounting hole spacing and diameter 184mm x 54mm x 14mm
Complies with AS4177



Override couplings

A800 50mm override coupling with 4 bolt holes rating 2000kg
Comes with a heavy-duty spring for 1200kg to 2000kg loads.
Painted finish with anti-rattle head adjustment screw and padlock facility
Reverse lockout facility to disable braking.
Mounting hole spacing and diameter 184mm x 54mm x 14mm
Complies with AS4177



A800Z 50mm override coupling with 4 bolt holes rating 2000kg
Comes with a heavy-duty spring for 1200kg to 2000kg loads.
Zinc plated finish with anti-rattle head adjustment screw and padlock facility
Reverse lockout facility to disable braking.
Mounting hole spacing and diameter 184mm x 54mm x 14mm
Complies with AS4177



A800L 50mm override coupling with 4 bolt holes rating 2000kg
Comes with a lighter spring for 750kg to 1200kg loads.
Zinc finish with anti-rattle head adjustment screw and padlock facility
Reverse lockout facility to disable braking.
Mounting hole spacing and diameter 184mm x 54mm x 14mm
Complies with AS4177



Off-road couplings

PB2000-OR Off-road polyblock override swivel coupling and towbar adapter with zinc finish. Rating 2000kg
Rotational and durable Polyblock with brass bushes and 19mm locking pin.
Grease nipples fitted for easy servicing.
Reverse lockout facility to disable braking when reversing.
4 bolt hole mounting hole spacing and diameter 184mm x 54mm x 14mm.
ADR approved.



PB3000 Off-road polyblock swivel coupling unbraked with towbar adapter rating 3000kg
Rotational and durable Polyblock with brass bushes and 19mm locking pin.
Grease nipples fitted for easy servicing.
Weldable base plate design. ADR approved.



OZHITCH2TG OzHitch off-road override coupling with 4 bolt holes. Galvanised rating 2000kg. The OzHitch is made from a high quality steel using a cast to create a one piece per section method of manufacture to make it stronger. ADR approved



OZHITCH3.5TG OzHitch off-road override coupling galvanised with 4 bolt holes. Rating 3500kg. Dual locking mechanism. The OzHitch is made from a high quality steel using a cast to create a one piece per section method of manufacture to make it stronger. ADR approved



Ring couplings

A791 75mm ring coupling with 4 bolt holes rating 2250kg
40mm ring thickness
Grease nipples fitted for servicing.
Mounting hole spacing and diameter 184mm x 54mm x 14mm
ADR approved.



A760 75mm fixed ring coupling with 3 bolt holes rating 3000kg
40mm ring thickness
Mounting hole spacing and diameter 102mm x 56mm x 5/8 inch
ADR approved.



Coupling spares

CAB Coupling adjuster bolt and nut



CAB

CAB-ARK Coupling adjuster bolt for ARK 2 and 3 bolt couplings



CAB-ARK

CLRLO Coupling latch reverse lockout



CLRLO

CLRLO-TRIGG Coupling latch reverse lockout for Trigg coupling



CLRLO-TRIGG

CTK Coupling trigger kit

CTK-TRIGG Coupling trigger kit for Trigg coupling

PB706 65mm x 20mm bolt and nut for off-road Trigg Polyblock

PB701 Towbar adapter for Trigg Polyblock

PBA Polyblock towbar adapter and car pin

PB703 19mm locking pin for Trigg Polyblock

PB704 Linchpin for Trigg Polyblock

CDH3.5 Coupling D handle for A900 coupling



CDH3.5



PBA



CTK-TRIGG

CTK



PB706



PB701

Coupling plates and bolts

CBP2 75 x 140 x 5mm coupling base plate for A150-2
Mounting hole spacing and diameter 102 x 14mm



CBP2

CBP4 100 x 225 x 8mm coupling base plate for A800 and A900.
Mounting hole spacing and diameter 184 x 54 x 14mm



CBP4

CBPV2 V shape coupling base plate for A150-2. Mounting hole
spacing and diameter 102 x 14mm

CBPV3 V shape coupling base plate for A150-3. Mounting hole
spacing and diameter 110 x 51 x 14mm.

CB112X12 1.5 inch x 0.5 inch high tensile trailer coupling bolt and nut.

CB212X12 2.5 inch x 0.5 inch high tensile trailer coupling bolt and nut.

CB412X12 4.5 inch x 0.5 inch high tensile trailer override coupling bolts.



CBPV2



CBPV3

Handbrake levers

- A803** Hydraulic handbrake bracket for use with A800 override couplings. Features anti-swing ratchet and allows full master cylinder travel. Compatible with 3/4 inch, 7/8 inch or 1 inch master cylinders.
- A803Z** Zinc plated hydraulic handbrake lever for use with A800 override couplings. Features anti-swing ratchet and allows full master cylinder travel. Compatible with 3/4 inch, 7/8 inch or 1 inch master cylinders.
- A807** Mechanical handbrake adapter plate for use with A800 override coupling. Handbrake lever and anti-swing ratchet to suit A-frame drawbar
- A807Z** Zinc plated mechanical handbrake adapter plate for use with A800 override coupling. Handbrake lever and anti-swing ratchet to suit A-frame drawbar
- HBL52** Handbrake lever for 50mm wide drawbar for boat trailers or single drawbar applications.
- HBL76** Handbrake lever for 75mm wide drawbar for boat trailers or single drawbar applications.
- HBL100** Handbrake lever for 100mm wide drawbar for boat trailers or single drawbar applications.
- HBRAKEASSY** Press button ratchet type handbrake assembly. Top mount. Zinc plated finish.
- 619150** Press button ratchet type handbrake assembly. Low profile, side mount. 280mm long handle with cable pulley attached.



Master cylinders and spares

MC34	3/4 inch trailer hydraulic master cylinder *
MC78	7/8 inch trailer hydraulic master cylinder *
MC1	1 inch trailer hydraulic master cylinder *
MC34CAP	Cap for 3/4 inch hydraulic master cylinder
MC78RES	Reservoir and cap for 7/8 inch hydraulic master cylinder
MCBOLTKIT	Bolt and nut for master cylinder clevis
CW1	Copper washer for use with HU4
HU4	Brass hydraulic union suit trailer override master cylinder and suit Trigg and ALKO calipers

* HU4 union and CW1 copper washer are required for installation of all master cylinders.



MC34CAP



MC34



MC78RES



MC78



CW1

HU4



MC1

Hitch pins

HP80	Hitch pin with R clip 65mm-80mm chrome Suits 2 inch x 2 inch class 4 receiver from 65mm to 80mm. Chrome plated finish. Towing rating 3500kg.
MTCP1405	Tow hitch receiver locking pin. Suits 50mm receiver style towbars. Simply remove existing 5/8 inch bolt and nut replace with the 5/8 inch locking stem. 2 keys included and rubber end cap.
MHARHP	Mister Hitches anti-rattle hitch pin lock. Fits all hollow shank and solid shank 2 inch ball mounts and receivers with a 5/8 inch pin hole. Protects the ball mount from theft and hitch rattle when towing or using bike carriers. Includes 2 keys and wrench. Replaces the standard hitch pin or other lock types. 3500kg capacity.
MHARHB	Mister Hitches anti-rattle hitch bracket. Fits all hollow shank and solid shank 2 inch ball mounts and receivers. Powder coated with zinc plated U-clamp includes nyloc nuts. Tightens your hitch into your receiver and stops hitch rattle when towing or using bike carriers and other accessories.



Coupling locks

TCL1	Tow coupling lock, single position
TCL2	Tow coupling lock 2 position locking system. Secures trailer when attached to vehicle and when unattached.
TCLPL	Trailer coupling lock padlock
MTCP1407	Coupling release lever lock for ball couplings supplied with 2 keys. Zinc finish. Suits quick release couplings and Treg, Trigg, AT35 style hitch pins and can also be used as spare wheel lock. Pin diameter 1/4 inch (6.3mm).



MTCP1407



TCL1



TCL2

Pintle hooks

MHPH10 Mister Hitches pintle hook 10 Tonne. Powder coated finish for use with pintle ring coupling. Comes with locking safety catch and mounting hardware. Unique design allows for easy opening and closing. ADR compliant. Mounting positions 85mm x 45mm x 13.5mm. Fits to pintle receiver arm (MHPRA)



MHPC1 Mister Hitches pintle hook combo 6 tonne. Powder coated finish for use with 50mm couplings or pintle ring. Comes with locking safety catch and mounting hardware (4 x Grade 8 nuts and bolts). ADR compliant. Pintle hook capacity: 6000kg; Tow ball capacity: 3500kg. Mounting positions 85mm x 45mm x 13.5mm. Fits to pintle receiver arm (MHPRA)



Pintle hook receivers and adapters

MHPRA Mister Hitches pintle receiver arm for mounting pintle hooks on vehicles with 2 x 2 inch towbar receivers. 8 hole with 4 mounting positions. 2 inch solid steel shank arm with heavy-duty 1/2 inch thick mounting plate and 5/8 inch hitch pin hole. Black powder coat finish. Working capacity: 4546kg (10000LBS).



MHPTBA Mister Hitches pintle tow ball adapter 4.5 tonne. Attaches to standard pintle hook mounting point and comes with a high tensile 12.9 grade mounting hardware kit and 32mm to 22mm tow ball reducing bush. Can be mounted to pintle receiver arm (MHPRA).



MHRB Tow ball reducing bush zinc plated. Reduces 1-1/4 inch shank tow balls to fit 7/8 inch shank 50mm tow balls.



Tow balls and accessories

TB50 50mm tow ball chrome rated 3500kg
Shank size: 1 inch diameter x 52mm in length.



TB50ES 50mm tow ball chrome extended shank 80mm long
Towing capacity: 2500kg
Shank size: 7/8 inch diameter and 80mm long.



TB50HR1 50mm tow ball 1 inch hi-rise chrome
Towing capacity: 2000kg
Shank size: 7/8 inch diameter and 51mm long.



TB70-4.5T 70mm tow ball towing capacity 4500kg
Shank size: 1.25 inch diameter x 68mm long.



MHBWS Tow ball weight scales. Tested to Australian Standards. Quality compression spring. Range 100kg to 350kg.

TBS41B Tow ball multi spanner – 3 tools in one. Tightening and removing tow ball, D shackles and axle nuts. Comfort grip. Chrome plated finish.

AC5005 Tow ball cover chrome plated plastic. Size: 50mm. Snaps on and holds securely. Keeps tow ball clean and enhances your vehicles appearance.



Towbar receiver hitches

* Always refer to the tow capacity of the towbar and vehicle.

MH001 Mister Hitches towbar receiver hitch ball mount. 190mm with 2 inch drop or 3/4 inch rise. Raises or lowers ball to the right level for towing. Black powder coated finish. Fits 2 x 2 inch towbar receivers. Gross trailer weight: 2722kg. Tongue weight: 272kg. Drop: 50mm (2 inch) Rise: 19mm (3/4 inch). Length: 190mm (measured from centre of pin hole to centre of ball hole). Ball hole size: 7/8 inch.



MH001HD Mister Hitches heavy-duty towbar receiver hitch ball mount. 51mm drop or 31mm rise with short shank. Reversible fit, either raises or lowers ball to the right level for towing. Black powder coated finish. Fits 2 x 2 inch towbar receivers. Extra heavy-duty 25mm thick x 75mm wide ball platform. Gross trailer weight: 3650kg. Tongue weight: 365kg. Drop: 51mm. Rise: 31mm. Length: 201mm (measured from centre of pin hole to centre of ball hole). Ball hole size: 7/8 inch.



MH002 Mister Hitches towbar receiver hitch ball mount. 254mm long with 2 inch drop or 3/4 inch rise. Reversible fit, either raises or lowers ball to the right level for towing. Black powder coated finish. Fits 2 x 2 inch towbar receivers. Gross trailer weight: 2722kg. Tongue weight: 272kg. Drop: 50mm (2 inch). Rise: 19mm (3/4 inch). Length: 254mm (measured from centre of pin hole to centre of ball hole). Ball hole size: 7/8 inch.



MH002HD Mister Hitches heavy-duty towbar receiver ball mount. 51mm drop or 31mm rise. Reversible raises or lowers the ball to the right level for towing. Black powder coated finish. Fits 2 x 2 inch towbar receivers. Extra heavy-duty 25mm thick x 75mm wide ball platform. Gross trailer weight: 3650kg. Tongue weight: 365kg. Ball hole size: 7/8 inch. Drop: 51mm. Rise: 31mm. Length: 254mm (measured from centre of the pin hole to the centre of ball hole)



MH004HD Mister Hitches heavy-duty towbar receiver ball mount. 102mm drop or 76mm rise. Reversible raises or lowers ball to the right level of towing. Black powder coated finish. Fits 2 x 2 inch towbar receivers. Extra heavy-duty 25mm thick x 75mm wide ball platform. Gross trailer weight: 3650kg. Tongue weight: 365kg. Ball hole size: 7/8 inch. Drop: 51mm. Rise: 76mm. Length: 254mm (measured from centre of pin hole to centre of ball hole).



MH006 Mister Hitches towbar receiver ball mount. 292mm with 6 inch drop or 4 3/4 inch rise. Reversible to raise or lower for the right level for towing. Black powder coated finish. Fits 2 x 2 inch towbar receivers. Gross trailer weight: 2268kg. Tongue weight: 227kg. Ball hole size: 7/8 inch. Drop: 152mm (6 inch). Rise: 121mm (4 3/4 inch). Length: 292mm (measured from the centre of pin hole to the centre of ball hole).



MH314 Mister Hitches towbar receiver ball mount. 273mm with 3 1/4 inch drop or 2 inch rise. Reversible raises or lowers ball to the right level for towing. Black powder coated finish. Fits 2 x 2 inch towbar receivers. Gross trailer weight: 2286kg. Tongue weight: 227kg. Ball hole size: 7/8 inch. Drop: 83mm (3 1/4 inch). Rise: 50mm (2 inch). Length: 273mm (measured from centre of pin hole to centre of ball hole).



MH402 Mister Hitches towbar receiver ball mount. Reversible 50mm drop or 30mm rise to get right level for towing. Black powder coated finish. 25 year warranty. Fits 40mm receivers (eg Subaru, VE Commodore). Gross trailer weight: 1600kg. Tongue weight: 160kg. Ball hole size: 7/8 inch. Drop: 50mm. Rise: 30mm. Length: 220mm (measured from centre of pin hole to centre of ball hole).



40mm receiver

MH404 Mister Hitches towbar receiver ball mount. Reversible 82mm drop or 61mm rise for right level for towing. Black powder coated finish. 25 year warranty. Fits 40mm receivers (eg. Subaru, VE Commodore). Gross trailer weight: 1600kg. Tongue weight: 160kg. Ball hole size: 7/8 inch. Drop: 82mm. Rise: 61mm. Length: 239mm (measured from centre of pin hole to centre of ball hole).



40mm receiver

Towbar receiver hitches...contd

* Always refer to the tow capacity of the towbar and vehicle.

MHABM Mister Hitches heavy-duty adjustable towbar receiver ball mount 16 stage. Adjustable and reversible fit with 432mm (17 inch) adjustable vertical travel. Includes 2 x 5/8 inch hitch pins and clips. Black powder coated finish. Fits 2 x 2 inch towbar receivers. Gross trailer weight: 2722kg. Tongue weight: 272kg. Ball hole size: 7/8 inch. Max drop: 232mm. Max rise: 200mm. Length: 305mm (measured from centre of pin hole to centre of ball hole).



MHABM-5T Mister Hitches heavy-duty adjustable towbar receiver ball mount 12 stage. Adjustable and reversible receiver hitch with 12 stages. 6 stages of drop at: 80mm, 100mm, 130mm, 140mm, 160mm, 180mm. 6 stages of rise at: 30mm, 60mm, 80mm, 100mm, 110mm, 145mm. Fits 2 x 2 inch towbar receivers and uses 12.9 Grade high tensile bolts. Black powder coated finish. Gross trailer weight: 2500kg. Tongue weight: 250kg. Max drop: 180mm. Max rise: 145mm. Length: 295mm (Measured from centre of pin hole to centre of ball hole).



MHABM-5XHD Mister Hitches extra heavy-duty adjustable towbar receiver ball mount 12 stage. Adjustable and reversible receiver hitch with 6 stages of drop: 80mm, 110mm, 130mm, 140mm, 160mm, 190mm and 6 stages of rise 50mm, 80mm, 105mm, 110mm, 135mm, 165mm. 9mm dual support gussets for added strength. Uses 12.9 grade high tensile 16mm bolts. 25mm x 75mm heavy-duty ball platform. Black powder coated finish. Fits 2 x 2 inch towbar receivers. Gross trailer weight: 4000kg. Tongue weight: 400kg. Ball hole size: 7/8 inch. Max drop: 190mm. Max rise: 165mm. Length: 305mm (measured from centre of pin hole to centre of ball hole).



MHABM-MU Mister Hitches adjustable multi-use towbar receiver ball mount. Tow and use the receiver mounted bike carrier at the same time. Quick adjustable drop and rise to suit most application. Ball platform is reversible for 8 adjustments. 2 x 2 inch receivers. Top receiver not be used for towing - capacity 160kg. Black powder coated finish. Gross trailer weight: 2722kg. Tongue weight: 272kg. Ball hole size: 7/8 inch (22mm). Drop: 51mm (2 inch). Length: 305mm (measured from centre of pin hole to centre of ball hole).



MHFBM2 Mister Hitches 4500kg ION forged towbar receiver hitch ball mount with 2 inch drop or 1 inch rise. Solid shank and drop forged for extreme durability. Reversible raises or lowers ball to the right level for towing. Fits 2 x 2 inch towbar receivers. Gross trailer weight: 4500kg. Tongue weight: 450kg. Ball hole size: 1 1/4 inch (reducing bush available to suit standard 7/8 inch / 50mm tow balls). Drop: 50mm (2 inch) Rise: 25mm (1 inch). Length: 224mm (measured from centre of pin hole to centre of ball hole).



MHFBM4 Mister Hitches forged towbar receiver ball mount with 4 inch drop or 3 inch rise. Drop forged and a solid shank for extreme durability. Reversible by raising or lowering the ball to the right level for towing. Fits 2 x 2 inch receivers. Gross trailer weight: 4500kg. Tongue weight: 450kg. Ball hole size: 1 1/4 inch (available is a reducing bush to reduce 1 1/4 inch to standard 7/8 inch to suit 50mm tow balls). Drop: 102mm (4 inch). Rise: 76mm (3 inch). Length: 242mm (measured from centre of pin hole to centre of ball hole).



Towbar receiver hitches...contd

* Always refer to the tow capacity of the towbar and vehicle.

MHFBMA2

Aluminium forged towbar receiver ball mount. One piece high grade aluminium and weld-free forged construction offering greater capacity. Gross trailer weight: 3630kg. Tongue weight: 363kg. Reversible by raising or lowering ball to the right level for towing. Drop: 51mm. Rise: 25mm. Length: 203mm. 25 year warranty.



MHFBMA4

Aluminium forged towbar receiver ball mount. One piece high grade aluminium and weld-free forged construction offers greater capacity. Reversible by raising or lowering the ball to the right level for towing. Drop: 102mm. Rise: 80mm. Length: 205mm. Gross trailer weight: 3630kg. Tongue weight: 363kg. 25 year warranty.



MHFBMA6

Aluminium forged towbar receiver ball mount. One piece high grade aluminium and weld-free forged construction offers greater capacity. Reversible by raising or lowering the ball to the right level for towing. Drop: 152mm. Rise: 130mm. Length: 237mm. Gross trailer weight: 3630kg. Tongue weight: 363kg. 25 year warranty.



MHRE9

Mister Hitches Hitch extender. Use with bike carriers when clearance is required for spare tyres. Black powder coat finish. Fits 2 x 2 inch towbar receivers. Gross trailer weight: 1600kg. Tongue weight: 160kg. Length: 228.6mm (measured between the pin hole centres). Total length: 356mm.



MHRE14

Mister Hitches Hitch extender. Use with bike carriers when clearance is required for spare tyres. Hitch capacity is reduced by approximately a third when using this hitch extender. Black powder coat finish. Fits 2 x 2 inch towbar receivers. Length: 356mm (measured between pin hole centres). Total length: 483mm.



MHSBM-1

Mister Hitches multi-use tow ball receiver ball mount. Able to tow and use a receiver mounted bike carrier at the same time. Top receiver not to be used for towing - capacity 160kg. 2 x 2 inch receiver mounts. Black powder coated finish. Gross trailer weight: 2722kg. Tongue weight: 272kg. Ball hole size: 7/8 inch (22mm). Drop: 51mm (2 inch). Length: 316mm (measured from centre of pin hole to centre of ball hole).



MHSBR

Mister Hitches step bumper universal towing towbar receiver hitch. Ideal for use on ATV, Farm machinery, or fitting to the front of vehicles for guiding a caravan or trailer into tight spots. Mounting hardware included such as bolts, nuts, washers and mounting plates. Reversible mounting positions. Black powder coated on enamel finish. Gross trailer weight: 1600kg. Tongue weight: 160kg.



MHARHB

Mister Hitches anti-rattle hitch bracket. Fits all hollow shank and solid shank 2 inch ball mounts and receivers. Powder coated with zinc plated U-clamp includes nyloc nuts. Tightens your hitch into your receiver and stops hitch rattle when towing or using bike carriers and other accessories.



Weight distribution

Mister Hitches Weight Distribution Systems are made from high grade steel and come with a 25 year manufacturers warranty. They are designed to evenly distribute the weight, levelling the ride from the towing vehicle through to the trailer or caravan. This increases the stability and control through improved steering and the correction of vehicle sag and creates a smoother towing experience.

Weight distribution systems are not suitable for off road use and some override braking systems.



- MHWDR6** Mister Hitches Weight Distribution System suitable for caravans with a ball weight of between 135kg and 275kg (600lb). Kit comes complete with solid steel shank, ball mount / head assembly, instructions etc. Solid steel shank is fully reversible and ball mount head are adjustable in rise up to 165mm and down to 63.5mm. The ball head angle is also adjustable giving many fitment positions. Features mount holes for sway bars. 31 inch spring bars are made from high grade steel. Comes with a 25 year manufacturers warranty. The spring bar chain brackets will fit "A" frames up to 3 inches wide x 8 inches deep.
- MHWDR8** Mister Hitches Weight Distribution System suitable for caravans with a ball weight of between 227kg and 365kg (800lb). Kit comes complete with solid steel shank, ball mount / head assembly, instructions etc. Solid steel shank is fully reversible and ball mount head are adjustable in rise up to 165mm and down to 63.5mm. The ball head angle is also adjustable giving many fitment positions. Features mount holes for sway bars. 31 inch spring bars are made from high grade steel. Comes with a 25 year manufacturers warranty. The spring bar chain brackets will fit "A" frames up to 3 inches wide x 8 inches deep.

Weight distribution components

- MHWDS10** Mister Hitches Weight Distribution standard shank found in the weight distribution kits. Length: 323mm. Drop (top of shank to top of ball platform): 63.5mm. Rise (top of shank to top of ball platform): 165mm. Shank overall height: 235mm. Shank is solid steel 50mm square suits Hayman Reese style towbar receivers.

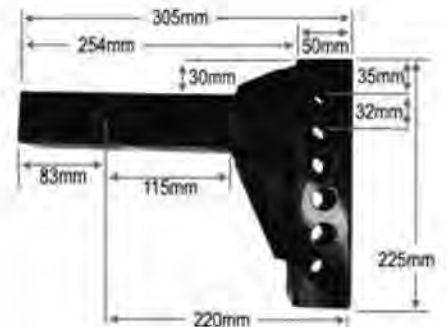

- MHWDS1011** Mister Hitches long shank to suit Weight Distribution System. This is optional when extra height or drop is required. Length: 323mm. Drop: 135mm. Rise: 254mm. Shank overall height: 286mm. Shank is solid steel 50mm square suits Hayman Reese style towbar receivers.



- MHWDS1014** Mister Hitches Extra long shank to suit Weight Distribution System. This is optional when extra height or drop is required. Length: 323mm. Drop: 229mm. Rise: 30mm. Shank overall height: 356mm. Shank is solid steel 50mm square suits Hayman Reese style towbar receivers.

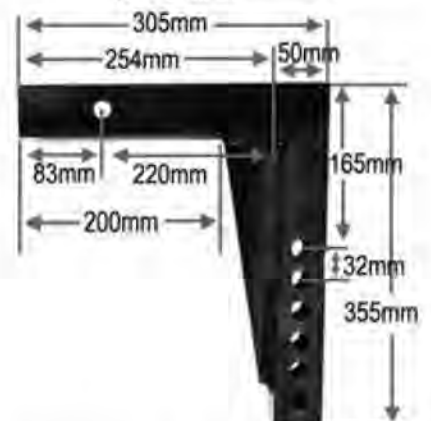

Chain, shackles, chain mounts

Pre-cut rated chain lengths

TC8-500	8mm zinc trailer safety chain rated to 1600kg* pre-cut to 500mm
TC8-1000	8mm zinc trailer safety chain rated to 1600kg* pre-cut to 1000mm
TC10-500	10mm zinc trailer safety chain rated to 2500kg* pre-cut to 500mm
TC10-1000	10mm zinc trailer safety chain rated to 2500kg* pre-cut to 1000mm
TC13-1000	13mm zinc trailer safety chain rated to 3500kg* pre-cut to 1000mm
TC10T-1000	T Grade (Grade 80) chain rated to 3200kg* for use above 3500kg ATM pre-cut to 1000mm



TC10 and TC13



TC10T-1000

Rated chain per metre *Minimum purchase length 3 metres.*

TC8	8mm zinc trailer safety chain rated to 1600kg*
TC10	10mm zinc trailer safety chain rated to 2500kg*
TC13	13mm zinc trailer safety chain rated to 3500kg*

* Load rated product and Australian Standards Compliant

Rated D shackles

DS8R	8mm D shackle rated to 750kg*
DS10R	10mm D shackle rated to 1000kg*
DS11R	11mm D shackle rated to 1500kg*
DS13R	13mm D shackle rated to 2000kg*
DS16R	16mm D shackle rated to 3200kg*

* Load rated product.



Chain connectors (hammerlocks) - rated

CC8R	8mm chain connector rated to 2000kg*
CC10R	10mm chain connector rated to 3150kg*
CC13R	13mm chain connector rated to 5300kg*

* Load rated product



Weld-on chain mounts - rated *Required on trailers above 3500kg ATM*

HLCL3.15	Weld-on bracket and chain connector rated to 3150kg*
HLCL5.3	Weld-on bracket and chain connector rated to 5300kg*



HLCL5.3

* Load rated product

Jockey wheels Spares available for most of our range of Jockey wheels and stands on pages 26, 27, 28.

6 inch jockey wheels

JWN6C-ECO 6 inch economy jockey wheel with clamp. Solid rubber wheel with nylon web bore.
 Wheel: 150mm x 50mm (6 inch x 2 inch)
 Lift: 225mm.
 Static load capacity: 350kg.



JWN6S-ECO 6 inch economy jockey wheel swivel/swing-up. With welded pin locking swivel bracket. Solid rubber wheel with nylon web bore.
 Lift: 225mm. Static load capacity: 350kg.



JWN6SU-ECO 6 inch economy jockey wheel swivel/swing-up. U-bolt with welded pin locking swivel bracket. For fixing with 2, 3, 4, 5 and 6 inch U-bolts. Solid rubber wheel with nylon web bore.
 Lift: 225mm. Static load capacity: 350kg.



8 inch jockey wheels - medium

JW4Z 8 inch jockey wheel clamp-on. Rubber tyre with zinc plated steel centre and roller bearings
 Wheel: 200mm x 55mm (8 inch x 2 inch).
 Lift: 225mm. Static load capacity: 700kg.



JW4ZB 8 inch jockey wheel swivel/swing-up bolt/weld-on with pin locking swivel bracket welded in position. Rubber tyre with zinc plated steel centre and roller bearings
 Wheel: 200mm x 55mm (8 inch x 2 inch).
 Lift: 225mm. Static load capacity: 700kg.



JW4ZUB

8 inch jockey wheel swivel/swing-up. U-bolt type with pin locking swivel bracket welded in position for fixing with 2, 3, 4, 5, and 6 inch U-bolts. Rubber tyre with zinc plated steel centre and roller bearings. Wheel: 200mm x 55mm (8 inch x 2 inch). Lift: 225mm. Static load capacity: 700kg.

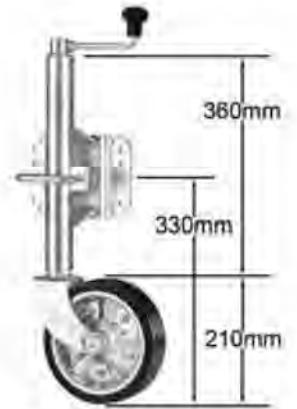

JW4ZEHNC

8 inch jockey wheel extra height no clamp. Rubber tyre with zinc plated steel centre and roller bearings. Wheel: 200mm x 55mm (8 inch x 2 inch). Lift: 225mm. Static load capacity: 700kg.

JW4ZEHNC is the same dimensions as this model shown but does not come with the clamp.



JWSW-4ZEH

8 inch jockey wheel extra height, side winding with clamp. Rubber tyre with zinc plated steel centre and roller bearings. Wheel: 200mm x 55mm (8 inch x 2 inch). Lift: 225mm. Static load capacity: 700kg.



U-bolts for mounting to chassis on page 81



10 inch jockey wheels

JW10C 10 inch jockey wheel clamp-on
 'Pneumatic look' solid cushion tyre with steel centre and bronze bush bore.
 Wheel: 4.10/3.50 x 4 tyre (10 inch). Lift: 225mm. Static load capacity: 650kg.



JW10S 10 inch jockey wheel swivel/swing-up weld/bolt-on with pin locking swivel bracket welded in position.
 'Pneumatic look' solid cushion tyre with steel centre and bronze bush bore.
 Wheel: 4.10/3.50 x 4 tyre (10 inch). Lift: 225mm. Static load capacity: 850kg.



JW10UBS 10 inch jockey wheel swivel/swing-up U-bolt type with pin locking swivel bracket welded in position for fixing with 2, 3, 4, 5 and 6 inch U-bolts.
 'Pneumatic look' solid cushion tyre with steel centre and bronze bush bore. Wheel: 4.10/3.50 x 4 tyre (10 inch).
 Lift: 225mm. Static load capacity: 850kg.



JWSW-11UBHDG 10 inch heavy-duty galvanised jockey wheel. Includes heavy-duty side winding assembly. Pin locking swivel bracket welded in lower position for fixing with U-bolts.
 Solid cushion tyre with galvanised steel centre and bronze bore bush. Wheel: 4.10/3.50 x 4 (10 inch). Lift: 225mm.
 Static load capacity: 1000kg.



JWN10SUP

10 inch pneumatic economy jockey wheel swivel/swing-up with low welded pin locking swivel bracket for fixing with 2, 3, 4, 5 and 6 inch U-bolts.
Pneumatic 4.10/3.50 x 4 (10 inch) tyre with steel centre and bearings.
Lift: 225mm. Static load capacity: 350kg.



JWN10EL

10 inch jockey wheel 'pneumatic look' extended height no clamp.
'Pneumatic look' solid cushion tyre 4.10/3.50 x 4 (10 inch) with steel centre and bronze bush bore.
Lift: 225mm. Static load capacity: 850kg.
* HDCLAMP48 or LDSBI is not included and is required.
See page 28



JW8UBG

10 inch extra heavy-duty jockey wheel swivel/swing-up U-bolt galvanised. Heavy-duty pin locking swivel bracket welded in position. For fixing with 4 and 5 inch U-bolts. Solid rubber tyre 250mm x 50mm (10 inch x 2 inch) with aluminium centre plain bore.
Lift: 225mm. Static load capacity: 1250kg.



JW11UBHDG

10 inch heavy-duty jockey wheel swivel/swing-up U-bolt galvanised. Heavy-duty pin locking swivel bracket welded in low position. For fixing with 2, 3, 4, 5 and 6 inch U-bolts. Also includes heavy-duty winding handle and thrust bearing. Solid cushion tyre 4.10/3.50 x 4 (10 inch) with galvanised steel centre and bronze bush bore.
Lift: 225mm. Static load capacity: 1000kg.



EASYMOVER ratchet jockey wheels

Designed for minimal effort and increased manoeuvrability, EASYMOVER by Manutec operates on either side of the draw bar with the same efficiency and has the unique feature of an unrestricted handle stroke. This enables the operator to determine the most comfortable drive stroke length and operating stance. Benefits of solid tyre jockey wheels: 100% reliability (no flats); more even load-share between the wheels; greater load capacity.

- EM1S 10 inch 'EASYMOVER' ratchet driven solid rubber jockey wheel with clamp.
Solid cushion 4.10/3.50 x 4 (10 inch) tyre with steel centre.
Lift: 225mm. Unit weight: 15.4kg. Static load capacity: 750kg.



- EM1SB 10 inch 'EASYMOVER' ratchet driven swivel/swing up solid rubber jockey wheel with pin locking swivel bracket welded in position.
Solid cushion 4.10/3.50 x 4 (10 inch) tyre with steel centre.
Lift: 225mm. Unit weight: 16.5kg. Static load capacity: 750kg.

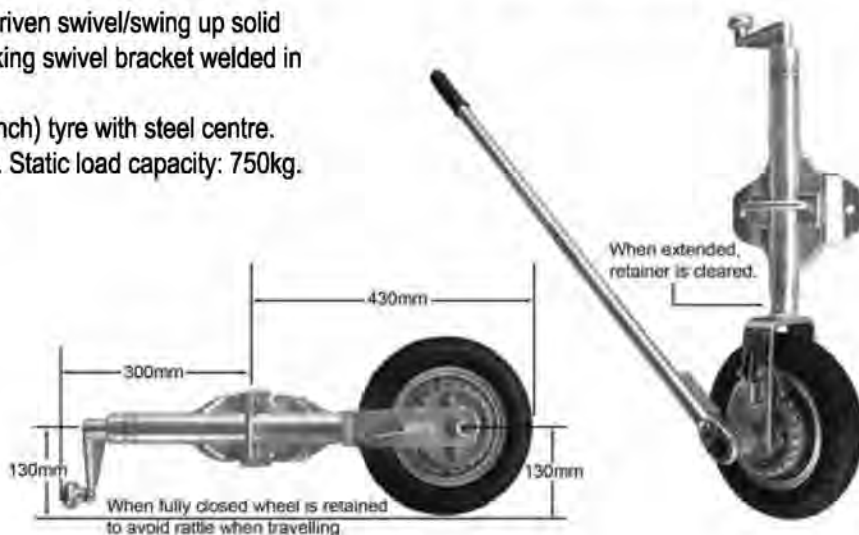

- EM2SHDC 10 inch 'EASYMOVER' ratchet driven twin solid rubber jockey wheel includes heavy-duty clamp (HDCLAMP48).
2 x Solid rubber wheel with steel centre 4.10/3.50 x 4 (10 inch).
Lift: 225mm. Unit weight 22.3kg.
Static load capacity: 900kg.



Jockey stands

Top winding adjustable stands

JS14 Standard adjustable stand with clamp. Top winding.
Lift: 225mm. Static load capacity: 650kg.



JS14B Standard adjustable stand with swivel/swing up.
Top winding with pin locking swivel bracket welded in position.
Lift: 225mm. Static load capacity: 650kg.

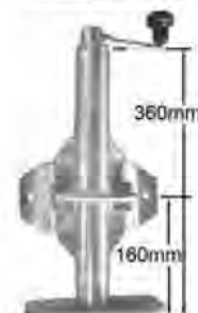

ASHDX Heavy-duty adjustable stand with extra height and heavy-duty pin locking swivel bracket supplied loose.
Top winding.
Lift: 225mm. Static load capacity: 1250kg.



JS27 Standard adjustable stand extended length with clamp.
Top winding. Lift: 225mm.
Static load capacity: 650kg



JSN1250HD Heavy-duty adjustable stand swivel/swing-up. Square tube 60mm x 60mm with heavy-duty swivel bracket welded in position. Top winding. Lift: 225mm. Static load capacity: 1250kg.



Side winding adjustable stands

ASSW-LN

Adjustable stand side winding.
Outer: 50 x 50 x 3mm. Lift: 210mm. Load rating: 750kg.

Mounting tube 622000 on page 28



ASSW-L

Adjustable stand side winding with pin locking swivel bracket welded for swing-up.
Outer: 50 x 50 x 3mm. Lift: 210mm. Load rating: 750kg.



ASSW-MLH

Adjustable stand side winding loose handle *, no swivel bracket or mounting tube.

Outer: 60 x 60 x 4mm. Lift: 350mm. Load rating: 1000kg

* Replacement loose handle AS-LOOSEHANDLE on page 26

Mounting tube 622000 on page 28
Swivel bracket SCLHD2000 on page 28

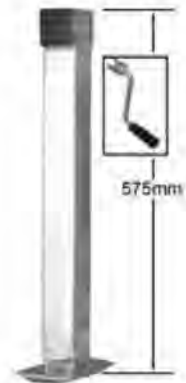

ASSW-DL

Adjustable stand heavy-duty side winding with drop leg.
Outer: 70 x 70 x 4mm. Lift: 350mm. Load rating: 1500kg.

Mounting tube 622000 on page 28
Swivel bracket SCLHD2000 on page 28



ASSW-DLLH

Adjustable stand heavy-duty side winding with drop leg and loose handle. *

Outer: 70 x 70 x 4mm. Lift: 350mm. Load rating: 1500kg

* Replacement loose handle AS-LOOSEHANDLE on page 26

Mounting tube 622000 on page 28
Swivel bracket SCLHD2000 on page 28

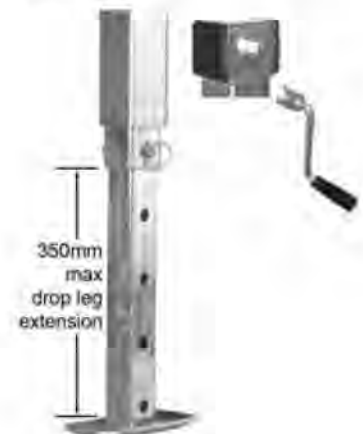

ASSW-H

Adjustable stand heavy-duty side winding.
Outer: 70 x 70 x 4mm. Lift: 350mm. Load rating: 2000kg.

Mounting tube 622001 on page 28



ASSW-1.4M

Adjustable stand side winding with loose handle. *
Outer: 60 x 60 x 4mm. Lift: 350mm. Load rating: 1000kg.

* Replacement loose handle AS-LOOSEHANDLE on page 26

Mounting tube 622000 on page 28



Over 4000kg rated side winding adjustable stands

ASSW-HD

Adjustable stand heavy-duty side winding black paint.
Outer: 80 x 80 x 4mm.
Closed height: 580mm.
Lift: 310mm. Load rating: 4000kg

Mounting tube 622001 on page 28



622110

Heavy-duty side winding landing leg 110 x 110mm square.
Static load capacity: 4500kg.
Zinc plated.

Mounting tube 622001 on page 28



Adjustable legs

No wheel

ALFM5 500mm adjustable leg zinc weld-on, no wheel.
Metric thread, hex head handle fitting.
Swing arc is away from operator.



ALFM6 600mm adjustable leg zinc weld-on, no wheel.
Metric thread, hex head handle fitting.
Swing arc is away from operator.



ALFP5 500mm adjustable leg zinc weld-on, no wheel.
Power thread, slotted type handle fitting.
Swing arc is towards operator.



ALFP6 600mm adjustable leg zinc weld-on, no wheel.
Power thread, slotted type handle fitting.
Swing arc is towards operator.



With wheel

ALRM5 500mm adjustable leg zinc weld-on, with wheel.
Metric thread, hex head handle fitting.
Swing arc is away from operator.



ALRM6 600mm adjustable leg zinc weld-on, with wheel.
Metric thread, hex head handle fitting.
Swing arc is away from operator.



ALRP5 500mm adjustable leg zinc weld-on, with wheel.
Power thread, slotted type handle fitting.
Swing arc is towards operator.



ALRP6 600mm adjustable leg zinc weld-on, with wheel.
Power thread, slotted type handle fitting.
Swing arc is towards operator.



Quick release adjustable legs

- Part numbers starting with ALQR are quick action stabilising legs.
- Pull handle to swing leg into lowest lock position (variable); take up support weight using hex head handle.
- These quick release legs are stabilising legs and not to be used as levelling legs. Support capacity varies depending on the angle of the leg and surface grip of the leg. A more vertical position will give greater load capacity, but will reduce stability.

ALQR1	400mm quick release adjustable leg weld-on. Lift: 120mm.
ALQR2	460mm quick release adjustable leg weld-on. Lift: 180mm.
ALQR3	520mm quick release adjustable leg weld-on. Lift: 140mm.
ALQR4LP	620mm quick release adjustable leg weld-on with large steel foot. Lift: 180mm.



Accessories and spares for Quick release adjustable legs

ALQRAF	Aluminium foot (large) for ALQR adjustable legs.
ALQRPCF	Plastic cover foot for ALQR adjustable legs.
ALQRWOM	Weld-on mounting bracket with bolts/nyloc nuts for ALQR adjustable legs.
PLASCAP-ALQTOP	Replacement plastic top cap to suit adjustable quick release legs (ALQR)
PLASCAPS50X50	Replacement plastic end caps for adjustable quick release legs (ALQR) with 50mm x 50mm tube
655901	Alko Big Foot corner steady feet (each)
655902	Alko Big Foot hardware kit



ALQRAF



ALQRPCF



ALQRWOM



655901



655902

Jockey wheel, legs and stand spares

Replacement wheels

JW6	6 inch (150mm) nylon wheel, 12mm shaft size – ARK
JW8	8 inch (200mm) solid rubber wheel with steel rim, 22mm shaft size - ARK
JW1505013	6 inch (150mm) solid rubber wheel, 13mm nylon bore
JW8-M	8 inch (200mm) solid rubber wheel, 16mm steel web bore
JW2005516ZC	8 inch (200mm) rubber tyre, zinc steel centre, 16mm roller bearing
JW10	10 inch (250mm) solid rubber wheel, steel rim, 16mm shaft size.
JW10P	10 inch (250mm) pneumatic rubber wheel, steel rim, 16mm shaft size.
JW350X4SR	10 inch (250mm) solid cushion rubber wheel, zinc plated centre, 19mm bronze bushes.



JW6

JW10



JW1505013

JW10P



JW8-M



JW2005516ZC



JW8



JW350X4SR

Stand and leg handles - hex head type

LH1M	Handle for quick release adjustable leg (ALQR) hex head 19mm length 600mm
LH2M	Handle for adjustable leg hex head type 19mm length 700mm
LH3M	Handle for adjustable leg hex head type 19mm length 900mm
LH2MD	Handle for adjustable leg hex head type 19mm length 590mm for electric drill application
AS-LOOSEHANDLE	Loose handle 19mm hex head type for adjustable stands ASSW-MLH, ASSW-DLLH

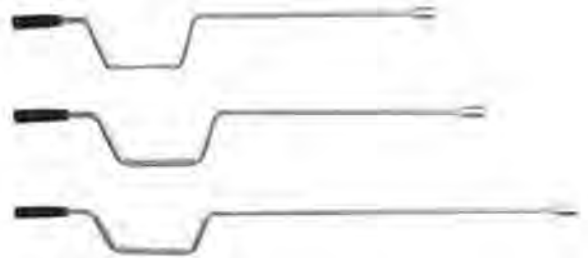

LH2MD use with a drill



Stand and leg handles - slotted type

LH1P	Handle for adjustable leg slotted type length 550mm
LH2P	Handle for adjustable leg slotted type length 700mm
LH3P	Handle for adjustable leg slotted type length 900mm
LH2PD	Handle for adjustable leg slotted type length 570mm for electric drill application

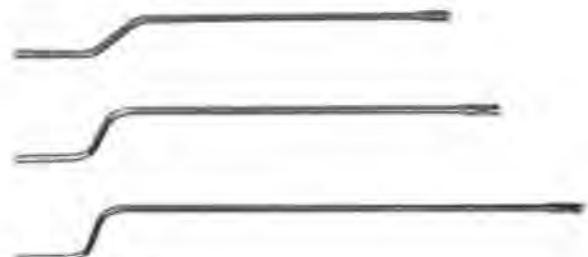

LH2PD use with a drill

Jockey wheel handles

JWH	Jockey wheel handle for standard Ark 350kg rated type jockey wheels.
JWH-GS	Jockey wheel handle grub screw type for all standard jockey wheels manufactured pre-2001.
JWH-HD	Jockey wheel handle heavy-duty for Ark 500kg rated jockey wheels.
JWH-RP	Jockey wheel handle roll pin type for all standard jockey wheels.
JWHANDLE-ECO	Jockey wheel handle for economy jockey wheels.
JWHANDLE-HDL	Jockey wheel extra-long handle with heavy-duty roll pin.
JWHANDLE-HDS	Jockey wheel handle with heavy-duty roll pin.
AS-LOOSEHANDLE	Loose handle 19mm hex head type for adjustable stands ASSW-MLH, ASSW-DLLH
629601	Jockey wheel handle Alko grub screw type
629625	Jockey wheel handle Alko dowel pin style.



JWHANDLE-HDS



JWHANDLE-HDL



JWH-GS



JWH-HD



JWH-RP



JWHANDLE-ECO



JWH



629625

Jockey wheel miscellaneous spares

JWAXLE20	Axle Shaft 3/4 inch (20mm) for JW9/10/10HD/11HD models
JWBTR16	Thrust race bearing ID 17mm OD 35mm for use with Manutec standard jockey wheels
JWBTR20	Thrust race bearing ID:17mm OD:35mm for use with Manutec heavy-duty jockey wheels and stands.
JWSCREW16	Lifting screw, 16mm power thread for standard and heavy-duty Manutec jockey wheels
629602SP	Jockey wheel thrust bearing for Alko jockey wheels under 500kg



JWAXLE20



JWBTR16



JWSCREW16

Clamps

CLAMP	Fixed clamp with 2 holes bolt-on or weld-on, for use with standard 48mm OD shaft jockey wheels.
FCL8	Fixed clamp with 8 holes for U-bolts, for use with 350kg jockey wheels.
FCL2HD	Heavy-duty clamp with 2 holes, bolt-on or weld-on, for use with 500kg jockey wheels.
SCL2	Swivel clamp with 2 holes for use with 350kg jockey wheels.
SCL8	Swivel clamp with 8 holes for use with 350kg jockey wheels.
SCLHD2000	Pin locking swivel bracket for heavy-duty adjustable stands with 70mm x 70mm outer tube. ASSW-H and ASSW-DL. Load capacity: 2000kg.
DOUBLECLAMP	Weld-on double clamp. Gives extra support on standard and medium range of jockey wheels and stands. Also ideal on extra height jockey wheels using 48mm outside diameter tube.
HDCLAMP48	Heavy-duty clamp weld-on for medium and heavy-duty range of jockey wheels and stands using 48mm outside diameter tube.
HDCLAMP60	Heavy-duty clamp weld-on for heavy-duty jockey wheels and stands with 60mm outside diameter tube.
LDSB1	Pin locking swivel/swing-up bracket bolt-on or weld-on for standard and medium jockey wheels and stands using 48mm outside diameter tube.
622000	Weld-on chassis mounting tubes (swivel) for landing legs. Rating 1000kg. OD tubes: 50mm and 60mm.
622001	Heavy-duty weld-on chassis mounting tubes (swivel) for landing legs. Rating 4000kg OD tubes: 60mm and 75mm
HDSB1	Heavy-duty pin locking swing up bracket for use with heavy-duty jockey wheels and stands with a 60mm outside diameter tube. Bolt-on or weld-on.
629935	Adjustable swivel jockey wheel bracket for Alko jockey wheels
CLAMP-ALKO	Jockey wheel clamp for standard Alko 350kg jockey wheels
DBLCLAMPHDL	Handle for double clamp with retaining bar
LDSB-HANDLE	Swing-up mechanism handle
CLAMPHANDLE	Clamp handle for standard clamp complete with retaining washer.



CLAMP



FCL8



FCL2HD



HDCLAMP48



HDCLAMP60



DOUBLECLAMP



SCL2



SCL8



SCLHD2000



LDSB1



HDSB1



629935



LDSB-HANDLE



DBLCLAMPHDL



CLAMPHANDLE



622000



622001

Axles and stub axles

- We stock a wide range of axle lengths in widths of 39mm round, 40mm square, 45mm square and 50mm square as well as stub axles.
- Axels are supplied with marine turn as default.
- Axles are available in black painted steel or galvanised finishes.
- Custom build lengths of axles, drop and overlay axles as well as assembled axles are all available on request.
- All axles and stub axles come with axle nuts, washers and split pins.

Straight axles are the most common type and our full listing of 39mm round, 40mm square, 45mm square, 50mm square axles and their ratings are listed in the following section. Ratings are determined by the lowest rating between the material and the bearing. Our ratings for straight axles are as follows:

- 39mm round with LM bearing (also called Holden bearing) = 1000kg (1 tonne)
- 40mm square with LM bearing (also called Holden bearing) = 1200kg (1.2 tonne)
- 45mm square with slimline (SL) bearing (also called Ford bearing) = 1500kg (1.5 tonne)
- 45mm square with parallel bearing = 1800kg (1.8 tonne)
- 50mm square with TX bearing = 2500kg (2.5 tonne)

Also available are overlay axles, a straight solid length of steel with stub axles welded on top of the steel; or drop axles, a straight solid length of steel with extra space created by welding drop plates between the steel and the stub axle.

Selecting the right axle

When selecting an axle for your trailer you need to consider the following:

Trailer ATM: the load rating of the axle must support the maximum ATM rating. For multiple axle trailers divide the ATM by the number of axles to determine the minimum load capacity of each axle.

Maximum trailer width in Australia is 2.5metres.

Tip-to-tip measurement: measure the overall length of the axle including the end of the spindle. This is called a tip-to-tip measurement. If you are unable to supply us with a tip-to-tip measurement and it is an existing trailer then we will need a face-to-face measurement. We can then work out a tip-to-tip from this.

A face-to-face measurement: From the face of the hub where the wheel bolts on, to the face on the other side where the wheel bolts on.

If it's a new trailer and you have built the chassis to get a face to face measurement follow the following steps:

A.

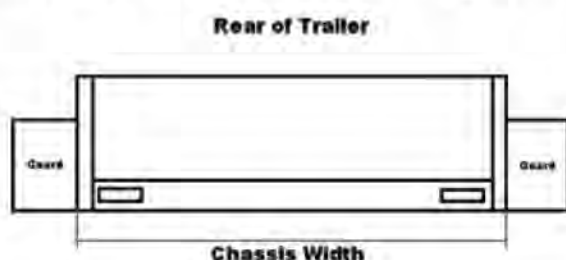

B. The clearance between the chassis and the wheel

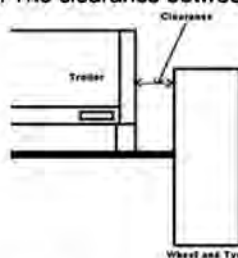

C.

The backspace of the rim. Put the wheel complete with tyre on a flat surface with the inside of the rim facing the flat surface and measure the distance from the surface to the inside of the rim.



A= Your chassis width = _____

B= Clearance = _____

C= Backspace = _____

(depending on the brakes you are using, your backspace may vary)

Face to face measurement = $A + (B \times 2) + (C \times 2)$

Axles rated from 1000kg to 1500kg per axle

All axles come with axle nuts, washers and split pins.

Length (tip to tip)	Rating and axle type with bearing						Sold as marine turn by default.	
	1000kg per axle = 39mm round with LM bearing		1200kg per axle = 40mm square with LM Bearing		1500kg per axle = 45mm square with slimline bearing			
	Black steel	Galvanised	Black steel	Galvanised	Black steel	Galvanised		
55 inch (1400mm)	AXS3955	AXS3955G	AXS4055	AXS4055G	AXS4555	AXS4555G		
56 inch (1425mm)	AXS3956	AXS3956G	AXS4056	AXS4056G	AXS4556	AXS4556G		
57 inch (1450mm)	AXS3957	AXS3957G	AXS4057	AXS4057G	AXS4557	AXS4557G		
58 inch (1475mm)	AXS3958	AXS3958G	AXS4058	AXS4058G	AXS4558	AXS4558G		
59 inch (1500mm)	AXS3959	AXS3959G	AXS4059	AXS4059G	AXS4559	AXS4559G		
60 inch (1525mm)	AXS3960	AXS3960G	AXS4060	AXS4060G	AXS4560	AXS4560G		
61 inch (1550mm)	AXS3961	AXS3961G	AXS4061	AXS4061G	AXS4561	AXS4561G		
62 inch (1575mm)	AXS3962	AXS3962G	AXS4062	AXS4062G	AXS4562	AXS4562G		
63 inch (1600mm)	AXS3963	AXS3963G	AXS4063	AXS4063G	AXS4563	AXS4563G		
64 inch (1625mm)	AXS3964	AXS3964G	AXS4064	AXS4064G	AXS4564	AXS4564G		
65 inch (1650mm)	AXS3965	AXS3965G	AXS4065	AXS4065G	AXS4565	AXS4565G		
66 inch (1675mm)	AXS3966	AXS3966G	AXS4066	AXS4066G	AXS4566	AXS4566G		
67 inch (1700mm)	AXS3967	AXS3967G	AXS4067	AXS4067G	AXS4567	AXS4567G		
68 inch (1730mm)	AXS3968	AXS3968G	AXS4068	AXS4068G	AXS4568	AXS4568G		
69 inch (1755mm)	AXS3969	AXS3969G	AXS4069	AXS4069G	AXS4569	AXS4569G		
70 inch (1780mm)	AXS3970	AXS3970G	AXS4070	AXS4070G	AXS4570	AXS4570G		
71 inch (1805mm)	AXS3971	AXS3971G	AXS4071	AXS4071G	AXS4571	AXS4571G		
72 inch (1830mm)	AXS3972	AXS3972G	AXS4072	AXS4072G	AXS4572	AXS4572G		
73 inch (1855mm)	AXS3973	AXS3973G	AXS4073	AXS4073G	AXS4573	AXS4573G		
74 inch (1880mm)	AXS3974	AXS3974G	AXS4074	AXS4074G	AXS4574	AXS4574G		
75 inch (1905mm)	AXS3975	AXS3975G	AXS4075	AXS4075G	AXS4575	AXS4575G		
76 inch (1930mm)	AXS3976	AXS3976G	AXS4076	AXS4076G	AXS4576	AXS4576G		
77 inch (1955mm)	AXS3977	AXS3977G	AXS4077	AXS4077G	AXS4577	AXS4577G		
78 inch (1980mm)	AXS3978	AXS3978G	AXS4078	AXS4078G	AXS4578	AXS4578G		
79 inch (2005mm)	AXS3979	AXS3979G	AXS4079	AXS4079G	AXS4579	AXS4579G		
80 inch (2030mm)	AXS3980	AXS3980G	AXS4080	AXS4080G	AXS4580	AXS4580G		
81 inch (2060mm)	AXS3981	AXS3981G	AXS4081	AXS4081G	AXS4581	AXS4581G		
82 inch (2085mm)	AXS3982	AXS3982G	AXS4082	AXS4082G	AXS4582	AXS4582G		
83 inch (2110mm)	AXS3983	AXS3983G	AXS4083	AXS4083G	AXS4583	AXS4583G		
84 inch (2135mm)	AXS3984	AXS3984G	AXS4084	AXS4084G	AXS4584	AXS4584G		
85 inch (2160mm)	AXS3985	AXS3985G	AXS4085	AXS4085G	AXS4585	AXS4585G		
86 inch (2185mm)	AXS3986	AXS3986G	AXS4086	AXS4086G	AXS4586	AXS4586G		
87 inch (2210mm)	AXS3987	AXS3987G	AXS4087	AXS4087G	AXS4587	AXS4587G		
88 inch (2235mm)	AXS3988	AXS3988G	AXS4088	AXS4088G	AXS4588	AXS4588G		
89 inch (2260mm)	AXS3989	AXS3989G	AXS4089	AXS4089G	AXS4589	AXS4589G		
90 inch (2285mm)	AXS3990	AXS3990G	AXS4090	AXS4090G	AXS4590	AXS4590G		
91 inch (2310mm)	AXS3991	AXS3991G	AXS4091	AXS4091G	AXS4591	AXS4591G		
92 inch (2335mm)	AXS3992	AXS3992G	AXS4092	AXS4092G	AXS4592	AXS4592G		
93 inch (2360mm)	AXS3993	AXS3993G	AXS4093	AXS4093G	AXS4593	AXS4593G		
94 inch (2390mm)	AXS3994	AXS3994G	AXS4094	AXS4094G	AXS4594	AXS4594G		
95 inch (2415mm)	AXS3995	AXS3995G	AXS4095	AXS4095G	AXS4595	AXS4595G		

Axes rated from 1800kg to 2500kg per axle

All axes come with axle nuts, washers and split pins.

Length (tip to tip)	Rating and axle type with bearing			
	1800kg per axle = 45mm square with parallel bearing		2500kg per axle = 50mm square with TX bearing	
	Black steel	Galvanised	Black steel	Galvanised
64 inch (1625mm)	AXS4564P	AXS4564PG	AXS5064TX	AXS5064TXG
65 inch (1650mm)	AXS4565P	AXS4565PG	AXS5065TX	AXS5065TXG
66 inch (1675mm)	AXS4566P	AXS4566PG	AXS5066TX	AXS5066TXG
67 inch (1700mm)	AXS4567P	AXS4567PG	AXS5067TX	AXS5067TXG
68 inch (1730mm)	AXS4568P	AXS4568PG	AXS5068TX	AXS5068TXG
69 inch (1760mm)	AXS4569P	AXS4569PG	AXS5069TX	AXS5069TXG
70 inch (1780mm)	AXS4570P	AXS4570PG	AXS5070TX	AXS5070TXG
71 inch (1805mm)	AXS4571P	AXS4571PG	AXS5071TX	AXS5071TXG
72 inch (1830mm)	AXS4572P	AXS4572PG	AXS5072TX	AXS5072TXG
73 inch (1855mm)	AXS4573P	AXS4573PG	AXS5073TX	AXS5073TXG
74 inch (1880mm)	AXS4574P	AXS4574PG	AXS5074TX	AXS5074TXG
75 inch (1905mm)	AXS4575P	AXS4575PG	AXS5075TX	AXS5075TXG
76 inch (1930mm)	AXS4576P	AXS4576PG	AXS5076TX	AXS5076TXG
77 inch (1955mm)	AXS4577P	AXS4577PG	AXS5077TX	AXS5077TXG
78 inch (1980mm)	AXS4578P	AXS4578PG	AXS5078TX	AXS5078TXG
79 inch (2005mm)	AXS4579P	AXS4579PG	AXS5079TX	AXS5079TXG
80 inch (2035mm)	AXS4580P	AXS4580PG	AXS5080TX	AXS5080TXG
81 inch (2060mm)	AXS4581P	AXS4581PG	AXS5081TX	AXS5081TXG
82 inch (2080mm)	AXS4582P	AXS4582PG	AXS5082TX	AXS5082TXG
83 inch (2110mm)	AXS4583P	AXS4583PG	AXS5083TX	AXS5083TXG
84 inch (2135mm)	AXS4584P	AXS4584PG	AXS5084TX	AXS5084TXG
85 inch (2160mm)	AXS4585P	AXS4585PG	AXS5085TX	AXS5085TXG
86 inch (2185mm)	AXS4586P	AXS4586PG	AXS5086TX	AXS5086TXG
87 inch (2210mm)	AXS4587P	AXS4587PG	AXS5087TX	AXS5087TXG
88 inch (2230mm)	AXS4588P	AXS4588PG	AXS5088TX	AXS5088TXG
89 inch (2260mm)	AXS4589P	AXS4589PG	AXS5089TX	AXS5089TXG
90 inch (2285mm)	AXS4590P	AXS4590PG	AXS5090TX	AXS5090TXG
91 inch (2310mm)	AXS4591P	AXS4591PG	AXS5091TX	AXS5091TXG
92 inch (2335mm)	AXS4592P	AXS4592PG	AXS5092TX	AXS5092TXG
93 inch (2360mm)	AXS4593P	AXS4593PG	AXS5093TX	AXS5093TXG
94 inch (2390mm)	AXS4594P	AXS4594PG	AXS5094TX	AXS5094TXG
95 inch (2415mm)	AXS4595P	AXS4595PG	AXS5095TX	AXS5095TXG

Sold as marine turn by default.

Bearing turn profiles - examples



39mm round axle with LM bearing with marine turn



40mm square axle with LM bearing with marine turn



45mm square axle with slimline bearing with marine turn



45mm square axle with parallel bearing with an electric turn



50mm square axle with TX bearing with marine turn

Stub axles 39mm round LM bearing rating 1000kg

SAX3910 39mm round 10 inch (254mm) long stub axle LM bearing

SAX3912 39mm round 12 inch (304mm) long stub axle LM bearing



Stub axles 40mm square LM bearing rating 1200kg

SAX4010 40mm square 10 inch (254mm) long stub axle LM bearing

SAX4012 40mm square 12 inch (304mm) long stub axle LM bearing



Stub axles 45mm round slimline bearing rating 1500kg

SAX4512RD 45mm round 12 inch (304mm) long stub axle slimline bearing



Stub axles 45mm square slimline bearing rating 1500kg

SAX4510 45mm square 10 inch (254mm) long stub axle slimline bearing

SAX4512 45mm square 12 inch (304mm) long stub axle slimline bearing



Stub axles 45mm square parallel bearing rating 1800kg

SAX4510P 45mm square 10 inch (254mm) long stub axle parallel bearing

SAX4512P 45mm square 12 inch (304mm) long stub axle parallel bearing



Stub axles 50mm square parallel bearing rating 2000kg

SAX5012P 50mm square 12 inch (304mm) long stub axle parallel bearing

SAX5025P 50mm square 25 inch (635mm) long stub axle parallel bearing*



Stub axles 50mm square TX bearing rating 2500kg

SAX5014TX 50mm square 14 inch (355mm) long stub axle TX bearing, marine turn with collar rating 2500kg

SAX5025TX 50mm square 25 inch (635mm) long stub axle TX bearing, marine turn with collar rating 2500kg *



* Commonly used for independent suspension arms.

All axles and stub axles come with axle nut, washer and split pins.
All axles and stub axles are provided as marine turn by default.

Axle pads and nuts

AP8	40 x 8mm axle pad
AP8G	40 x 8mm galvanised axle pad
AXNK1-C	Axle nut, washer and split pin 1 inch coarse thread
AXNK1-F	Axle nut, washer and split pin 1 inch fine thread
AXNK34	Axle nut, washer and split pin to suit 3/4 inch
AXNK78	Axle nut, washer and split pin to suit 7/8 inch
SPLITPIN	Replacement split pin



Assembled axles

With the widest range of braking product, we assemble axles with brakes. The wide range includes combinations of mechanical, electrical, disc brakes; including stainless steel ventilated disc rotors, galvanised, painted, stainless, aluminium parts. Our brake section includes options to be fitted or talk to our team for the best combination for your trailer.

Assembled axles will incur a lead time, please ask about the timeframe before placing your order.

These items are a custom build and are a non-refundable item, please ensure your axle length and brake choice is correct. Guidelines on selecting axles are on page 29 or contact us directly.

Unbraked lazy axles

39mm round axle with LM bearings rated 1000kg with lazy hubs

40mm square axle with LM bearings rated 1200kg with lazy hubs



Assembled axles with 9 inch hydraulic drum

40mm square axle with LM bearings rated 1200kg with 9 inch hydraulic drum brakes

45mm square axle with slimline bearings rated 1500kg with 9 inch hydraulic drum brakes

Assembled axles with 9 inch mechanical drum

40mm square axle with LM bearings 1200kg rated with 9 inch mechanical drum

Assembled axles with electric drum brakes

40mm square axle with LM bearings 1200kg rated with 10 inch electric drum brakes

45mm square axle with slimline bearings 1500kg rated with 10 inch electric drum brakes

45mm square axle with parallel bearings 1800kg rated with 10 inch electric drum brakes

45mm square axle with parallel bearings 1800kg rated with 12 inch electric drum brakes

50mm square axle with TX bearings 2500kg rated with 12 inch electric drum brakes



Assembled axles with mechanical disc brakes

40mm square axle with LM bearings 1200kg rated with 10 inch mechanical disc brakes

45mm square axle with slimline bearings 1500kg rated with 10 inch mechanical disc brakes

45mm square axle with slimline bearings 1500kg rated with 12 inch mechanical disc brakes

45mm square axle with parallel bearings 1800kg rated with 12 inch mechanical disc brakes

50mm square axle with TX bearings 2000kg rated with 12 inch mechanical disc brakes



Assembled axles with hydraulic disc brakes

40mm square axle with LM bearings 1200kg rated with 10 inch hydraulic disc brakes assembled

45mm square axle with slimline bearings 1500kg rated with 10 inch hydraulic disc brakes assembled

45mm square axle with slimline bearings 1500kg rated with 12 inch hydraulic disc brakes assembled

45mm square axle with parallel bearings 1800kg rated with 12 inch hydraulic disc brakes assembled

50mm square axle with TX bearings 2500kg rated with 12 inch hydraulic disc brakes assembled



Bearing and multi-purpose grease

Morey's RED-i Waterproof Marine Grease is designed for the environmentally conscious user. RED-i allows users to minimise the negative impact on the environment while exceeding the toughest demands and highest performance standards maintaining a cleaner environment leaving a legacy of superiority in all areas. Containing polymers, anti-wear agents, tackiness additives and rust and corrosion inhibitors. This grease is designed to "stay-in-place" and lubricate under the most severe operating conditions found in marine service. It is unsurpassed in resisting water wash-out and protecting against wear in shock loading applications.

43004-MG Morey red-i marine grease 450g cartridge

430045-MG Morey red-i marine grease 500g tub

43005-MG Morey red-i marine grease 2.5kg tin

Also available in 20kg size.



Morey red-i

Bearing identification

This listing contains only some common bearing combinations. Different applications may have other bearing numbers and combinations that are not shown in this table.

Bearing type	Inner bearing/cone		Outer bearing/cone	
	Number	Dimensions (ID x OD x width)	Number	Dimensions (ID x OD x width)
LM (Holden)	LM67048/10	31.750mm x 59.131mm x 15.875mm	LM11949/10	19.050mm x 45.237mm x 15.494mm
Slimline (Ford)	LM68149/10	34.988mm x 59.131mm x 15.875mm	LM12749/10	21.986mm x 45.237mm x 15.494mm
Composite	LM67048/10	31.750mm x 59.131mm x 15.875mm	LM12749/10	21.986mm x 45.237mm x 15.494mm
Parallel	LM68149/10	34.988mm x 59.131mm x 15.875mm	LM68149/10	34.988mm x 59.131mm x 15.875mm
M/T	25580/20	44.450mm x 82.931mm x 23.812mm	LM67048/10	31.750mm x 59.131mm x 15.875mm
TB500	30308	40mm x 90mm x 25.25mm	15123/245	31.750mm x 62mm x 18.161mm
Dexter axle model D60	25580/20	44.450mm x 82.931mm x 23.812mm	15123/245	31.750mm x 62mm x 18.161mm
USA 1.8t / Dexter axle model D35	L68149/11	34.987mm x 59.975mm x 15.875mm	L44649/10	26.99mm x 50.292mm x 14.224mm
Dexter axle model D44	L68149/11	34.988mm x 59.974mm x 15.875mm	LM67048/10	31.75mm x 59.131mm x 15.875mm
USA / Dexter Can be hub 8-91A	L44643	25.4mm x 50.292mm x 14.224mm	L44643	25.4mm x 50.292mm x 14.224mm
USA / Dexter	L44649/10	26.99mm x 50.292mm x 14.224mm	L44649/10	26.99mm x 50.292mm x 14.224mm
TX	30210/10	50mm x 90mm x 21.75mm	15123/245	31.750mm x 62mm x 18.161mm
ALKO 1.5t	LM29749/10	38.1mm x 65.088mm x 18.034mm	LM67048/10	31.750mm x 59.131mm x 15.875mm
ALKO 2t	30210/10	50mm x 90mm x 21.75mm	15123/245	31.750mm x 62mm x 18.161mm
ALKO 3t	30210/10	50mm x 90mm x 21.75mm	LM29749/10	38.1mm x 65.088mm x 18.034mm

Bearing tools

- 22200 Universal bearing packer
- DKCG-481N STM eco trigger grease gun
- DKCG-500 STM lever grease gun 450g



Bearings

Quality economy bearings

HBS32	LM outer bearing set LM11949/10
HBL32	LM inner bearing set LM67048/10
FBS35	Slimline outer bearing set LM12749/10
FBL35	Slimline inner bearing set L68149/10
TXS60	TX outer bearing set 15123/245
TXL60	TX inner bearing set 30210/10
USBS35	USA bearing outer L44649/10
USBL35	USA bearing inner L68149/11
25580/20-C	Bearing set Dexter, M/T and others



*LM is also called Holden bearing
Slimline is also called Ford bearing*

Quality premium bearings - Koyo, Timken or NSK

LM11949/10	LM outer bearing set Dimensions: 19.050mm (0.75 inch) ID; 45.237mm (1.7810 inch) OD; 15.494mm (0.61 inch) width.
LM67048/10	LM inner bearing set dimensions: 31.750mm (1.25 inch) ID; 59.131mm (2.3280 inch) OD; 15.875mm (0.6250) width.
LM12749/10	Slimline outer bearing set Dimensions: 21.986mm ID; 45.237mm OD; 15.494mm width.
L68149/10	Slimline inner bearing set Dimensions: 34.988mm ID; 59.131mm OD; 15.875mm width.
L44649/10	Bearing set (outer USA) Dimensions: 26.99mm (1.0625 inch) ID; 50.292mm (1.98 inch) OD; 14.224mm (0.56 inch) width.
L68149/11	Bearing set (inner USA) Dimensions: 34.987mm (1.3775 inch) ID; 59.975mm (2.3280 inch) OD; 15.875mm (0.6250 inch) width.
30210/10	Bearing set Dimensions: 50mm ID; 90mm OD; 21.75mm width
LM501349/14	Bearing set Dimensions: 41.275mm ID; 73.431mm OD; 21.430mm width.
25580/20	Bearing set Dimensions: 44.450mm ID; 82.931mm OD; 25.400mm width.
LM29749/10	Bearing set Dimensions: 38.1mm ID; 65.088mm OD; 18.034mm width.
15123/245	Bearing set outer bearing Dimensions: 31.75mm ID; 62mm OD; 19.05mm width.
30205	Bearing set Dimensions: 25mm ID; 52mm OD; 16.25mm width.
32007	Bearing set Dimensions: 35mm ID; 62mm OD; 18mm width.
L44643/10	Bearing set (USA) Dimensions: 25.4mm (1 inch) ID; 50.292mm (1.98 inch) OD; 14.224mm (0.56 inch) width.



*This flag identifies parts commonly
found on American designed trailers*



Seals

BS32	Seal 37 x 59 x 10mm (for LM bearings)	
BS35	Seal 44 x 59 x 10mm (for slimline bearings)	
BS60	Seal 60 x 90 x 13mm (for TX bearings, Alko 2000kg and 3000kg)	
MS32	Marine seal 37 x 59 x 10mm (for LM bearings)	
MS35	Marine seal 44 x 59 x 10mm (for slimline bearings)	
MS60	Marine seal 60 x 90 x 13mm (for TX bearings Alko 2000kg and 3000kg)	
493015	Seal 52 x 69 x 10mm (for Alko 1500kg)	
493017	Marine seal 52 x 69 x 10mm (for Alko 1500kg)	
13751983312	Seal 1.375 x 1.983 x 0.312 inch	
15001987250	Seal 1.500 x 1.987 x 0.250 inch	
171256500	Seal 1.71 x 2.56 x 0.5 inch	
1752328255	Seal 1.75 x 2.328 x 0.255 inch	
18130037	Seal 1.81 x 3.00 x 0.37 inch	
193730037	Seal 1.937 x 3.000 x 0.312 inch	
2003376400	Seal 2.00 x 3.376 x 0.4 inch	
2003376400MS	Marine seal 2.00 x 3.376 x 0.4 inch	
21253376500	Seal 2.125 x 3.376 x 0.5 inch	
2253375500	Seal 2.25 x 3.375 x 0.5 inch	
23133746	Seal 2.31 x 3.37 x 0.46 inch	



Bearing protectors (bearing buddies)

BP45	45mm stainless steel bearing protector 1 pair with caps	
BP51	51mm (1.98 inch) bearing protector with caps for USA hubs. 1 pair	
BP63	63mm stainless steel bearing protector . 1 pair	



Replacement caps for bearing protectors

BP45CAPS	Replacement caps for BP45 Bearing protectors 1 pair
BP51C	Replacement caps for BP51 Bearing protectors 1 pair
BP63C	Replacement caps for BP63 Bearing protectors 1 pair



Identifying hub types

All of the hub assemblies at Trailer Spares Direct come with seals, bearings with the cups (races already pressed), studs and stud nuts and dust caps. Lazy hubs, hub drums and disc hubs all come in a range of different stud pattern and bearing combinations, so when you are replacing a hub it is important to identify the correct hub from your trailer. For example, it is possible to have a Ford stud pattern with LM (Holden) bearings. Our complete listing follows this section.

The best way to identify your hub is to bring the old hub into the store so we can do this for you. Alternatively, the following is a guide to determine what hub type you are replacing.

1. Number and size of studs on your hub.
2. Work out the stud pattern by measuring the PCD (Pitch circle diameter).
The diagram below illustrates how to do this on 4, 5 and 6 stud hubs.

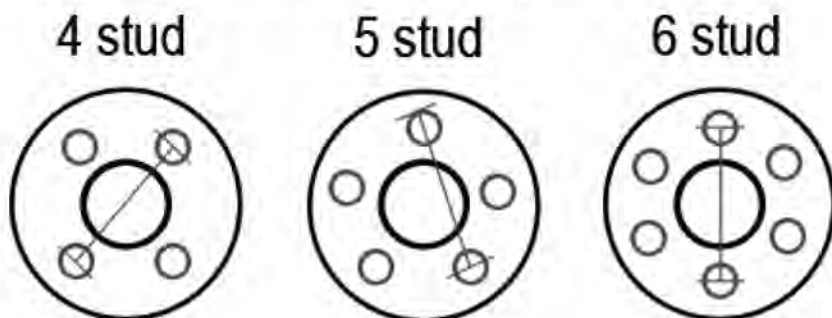

Stud pattern identification

Type	Number of studs	Stud diameter (Inches)	PCD (Inches)	PCD (mm)	Stud distance (mm)
HT Holden	5	7/16	4 15/16 (4.9375)	108	63
HQ Holden	5	7/16	4 3/4 (4.75)	120.6	71
Commodore	5	7/16	4 25/32 (4.7813)	120	71
Ford Falcon	5	1/2	4.5	114.3	67
Ford 4 stud	4	1/2	4.5	114.3	81
Ford 100	5	1/2	5.5	140	82
Land Cruiser	6	1/2	5.5	139.7	70
Land Cruiser	5	9/16	5.91	150	88
Nissan	6	1/2	5.5	139.7	70
Land Rover	5	5/8	6.5	165.1	97
Land Rover	5	9/16	6.5	165.1	97
Mini / Torana	4	7/16	4.0	101.6	72
Gemini	4	7/16		100.0	71

3. Identify inner and outer bearing. Bearings have the number stamped into them and you can refer to our bearing identification table on page 35.





Lazy hubs

All hub assemblies come complete with studs, nuts, bearings, seal and dust cap.

*Trailer studs are 7/16 inch, 1/2 inch or 9/16 inch.

5.5 inch hub assembly

- HT140G 5.5inch hub assembly HT stud LM bearing galvanised.
For use with 8inch aluminium rims (RIM8HT)
- IH20004X4G 5.5 inch hub assembly 4 x 1/2inch studs, 4inch PCD.
Suits USA 2000lb axles with parallel L44649/10 bearing galvanised. 
- IH20005X4.5G 5.5 inch hub assembly 5 x 1/2inch studs, 4.5inch PCD (Ford).
Suits USA 2000lb axles with parallel L44649/10 bearing galvanised 



IH20004X4G

6 inch hub assembly

- CD150 6 inch hub assembly Commodore 5 stud LM bearing
- CD150G 6 inch hub assembly Commodore 5 stud LM bearing galvanised
- CDF150 6 inch hub assembly Commodore 5 stud slimline bearing
- CDF150G 6 inch hub assembly Commodore 5 stud slimline bearing galvanised
- FD150 6 inch hub assembly Ford 5 stud slimline bearing
- FD150G 6 inch hub assembly Ford 5 stud slimline bearing galvanised
- FH150 6 inch hub assembly Ford 5 stud LM bearing
- FH150G 6 inch hub assembly Ford 5 stud LM bearing galvanised
- GH150 6 inch hub assembly Gemini 4 stud LM bearing
- TH150G 6 inch hub assembly Toyota/Nissan 4 stud galvanised
- HQ150 6 inch hub assembly HQ 5 stud LM bearing
- HQ150G 6 inch hub assembly HQ 5 stud LM bearing galvanised
- HQF150 6 inch hub assembly HQ 5 stud slimline bearing
- HT150 6 inch hub assembly HT 5 stud LM bearing
- HT150G 6 inch hub assembly HT 5 stud LM bearing galvanised
- HTF150 6 inch hub assembly HT 5 stud slimline bearing
- HTF150G 6 inch hub assembly HT 5 stud slimline bearing galvanised
- FD150GUS1.8 6 inch hub assembly Ford 5 stud USA 1.8t bearing galvanised 



FH150



HT150G



FD150GUS1.8

7.5 inch hub assembly

- F100H190G 7.5 inch hub assembly F100 5 Stud LM bearing galvanised
- F100F190G 7.5 inch hub assembly F100 5 Stud slimline bearing galvanised
- LF190 7.5 inch hub assembly 6 stud slimline bearing
- LF190G 7.5 inch hub assembly 6 stud slimline bearing galvanised
- LF1905 7.5 inch hub assembly LandCruiser 5 stud slimline bearing
- LF1905G 7.5 inch hub assembly LandCruiser 5 stud slimline bearing galvanised
- LH190 7.5 inch hub assembly 6 stud LM bearing
- LH190G 7.5 inch hub assembly 6 stud LM bearing galvanised
- LH1905 7.5 inch hub assembly LandCruiser 5 stud LM bearing
- LH1905G 7.5 inch hub assembly LandCruiser 5 stud LM bearing galvanised
- LP190G 7.5 inch hub assembly 6 stud parallel bearing galvanised
- LP1905G 7.5 inch hub assembly LandCruiser 5 stud parallel bearing galvanised
- LTX190G 7.5 inch hub assembly 6 stud TX bearing galvanised. Suits K12TX disc rotors
- LTX1905G 7.5 inch hub assembly LandCruiser 5 stud TX bearing galvanised. Suits K12LC5TX disc rotors

Hub drum assemblies

9 inch hub drums All drum assemblies come complete with studs, nuts, bearings, seal and dust cap.

HD9X134FD	9 x 1.75 inch hub drum Ford 5 stud slimline bearing
HD9X134FH	9 x 1.75 inch hub drum Ford 5 stud LM bearing
HD9X134HQ	9 x 1.75 inch hub drum HQ 5 stud LM bearing
HD9X134HQF	9 x 1.75 inch hub drum HQ 5 stud slimline bearing
HD9X134HT	9 x 1.75 inch hub drum HT 5 stud LM bearing
HD9X134HTF	9 x 1.75 inch hub drum HT 5 stud slimline bearing
HD9X134LF	9 x 1.75 inch hub drum 6 stud slimline bearing
HD9X134LH	9 x 1.75 inch hub drum 6 stud LM bearing
HD9X134CD	9 x 1.75 inch hub drum Commodore 5 stud LM bearing
HD9X134CDF	9 x 1.75 inch hub drum Commodore 5 stud slimline bearing
HD9X134LF5	9 x 1.75 inch hub drum LandCruiser 5 stud slimline bearing
HD9X134LH5	9 x 1.75 inch hub drum LandCruiser 5 stud LM bearing
HD9X134LRH	9 x 1.75 inch hub drum Land Rover 5 stud LM bearing (9/16 165mm PCD)
HD9X134LRF	9 x 1.75 inch hub drum Land Rover 5 stud slimline bearing (9/16 165mm PCD)
HD9X134F100H	9 x 1.75 inch hub drum Ford F100 LM bearing
HD9X134F100F	9 x 1.75 inch hub drum Ford F100 slimline bearing



*Trailer studs are 7/16 inch, 1/2 inch or 9/16 inch.

10 inch hub drums All drum assemblies come complete with studs, nuts, bearings, seal and dust cap.

HD10X2COM	10 x 2.25 inch hub drum Commodore 5 stud LM bearing
HD10X2COMF	10 x 2.25 inch hub drum Commodore 5 stud slimline bearing
HD10X2FD	10 x 2.25 inch hub drum Ford 5 stud slimline bearing
HD10X2FDP	10 x 2.25 inch hub drum Ford 5 stud parallel bearing
HD10X2FH	10 x 2.25 inch hub drum Ford 5 stud LM bearing
HD10X2HQ	10 x 2.25 inch hub drum HQ 5 stud LM bearing
HD10X2HQF	10 x 2.25 inch hub drum HQ 5 stud slimline bearing
HD10X2HT	10 x 2.25 inch hub drum HT 5 stud LM bearing
HD10X2HTF	10 x 2.25 inch hub drum HT 5 stud slimline bearing
HD10X2LF	10 x 2.25 inch hub drum 6 stud slimline bearing
HD10X2LH	10 x 2.25 inch hub drum 6 stud LM bearing
HD10X2LF5	10 x 2.25 inch hub drum LandCruiser 5 stud slimline bearing
HD10X2LP	10 x 2.25 inch hub drum 6 stud parallel bearing



*Trailer studs are 7/16 inch, 1/2 inch or 9/16 inch.

10 inch hub drums (contd...)

HD10X2FDUS1.8	10 x 2.25 inch hub drum Ford 5 stud US1.8 bearing	
HD10X2LUS1.8	10 x 2.25 inch hub drum 6 stud US1.8 bearing	
HD10X2LP5	10 x 2.25 inch hub drum LandCruiser 5 stud parallel bearing	
HD10X2LH5	10 x 2.25 inch hub drum LandCruiser 5 stud LM bearing	
HD10X2LRH	10 x 2.25 inch hub drum Land Rover 5 stud LM bearing (9/16 165mm PCD)	
HD10X2LRF	10 x 2.25 inch hub drum Land Rover 5 stud slimline bearing (9/16 165mm PCD)	
HD10X2LRP	10 x 2.25 inch hub drum Land Rover 5 stud parallel bearing (9/16 165mm PCD)	<i>*Trailer studs are 7/16 inch, 1/2 inch or 9/16 inch.</i>
HD10X2F100H	10 x 2.25 inch hub drum Ford F100 LM bearing	
HD10X2F100F	10 x 2.25 inch hub drum Ford F100 slimline bearing	
HD10X2F100P	10 x 2.25 inch hub drum Ford F100 parallel bearing	

12 inch hub drums All drum assemblies come complete with studs, nuts, bearings, seal and dust cap.

HD12X2LTX	12 x 2.25 inch hub drum 6 stud TX bearing
HD12X2LTX5	12 x 2.25 inch hub drum LandCruiser 5 stud TX bearing
HD12X2LCD	12 x 2.25 inch hub drum 6 stud with Dexter bearing combination 25580/20 and 15123/245



HD12X2LTX

12 inch brake drums (drum only) Extended length wheel studs for use with 2 piece drums and rotors

BDP12L	12 x 2.25 inch brake drum 6 stud used with ALKO 1.5t, 2.0t and 3t lazy hub
--------	--



BDP12L

Disc hub measurements and identification

Part	Hat height	Diameter of disc	Spigot diameter	Rotor thickness
DH34FDUS1.8	60mm	9.6 inch	73mm	3/4 inch
DH12HTFG-VELOX	128mm	10 inch	57mm	1/2 inch
DH12HTG-VELOX	128mm	10 inch	57mm	1/2 inch
DH58CDG-10	78mm	10 inch	60mm	5/8 inch
DH58CDFG-10	78mm	10 inch	60mm	5/8 inch
DH58HQG-10	78mm	10 inch	60mm	5/8 inch
DH58HQFG	78mm	10 inch	60mm	5/8 inch
DH58FDG-10	78mm	10 inch	60mm	5/8 inch
DH58FHG-10	78mm	10 inch	60mm	5/8 inch
DH58HTG-10	78mm	10 inch	60mm	5/8 inch
DH58HTFG-10	78mm	10 inch	60mm	5/8 inch
DH78FDGUS1.8	62mm	10 inch	65mm	7/8 inch
DH585LFG	64mm	12 inch	75mm	5/8 inch
DH585LPG	64mm	12 inch	106mm	5/8 inch
DH58LFG	64mm	12 inch	75mm	5/8 inch
DH58LPG	64mm	12 inch	106mm	5/8 inch
DH58LTXG	80mm	12 inch	105mm	5/8 inch
DH585LTXG	80mm	12 inch	105mm	5/8 inch
K10	61mm	11 inch	76mm	7/8 inch
K10SS	61mm	11 inch	76mm	7/8 inch
K10FDHT	61mm	11 inch	76mm	7/8 inch
K12	75mm	12 inch	93mm	7/8 inch
K12SS	75mm	12 inch	93mm	7/8 inch
K12TX	75mm	12 inch	108mm	7/8 inch
K12SSTX	75mm	12 inch	108mm	7/8 inch
K12LC5TX	75mm	12 inch	108mm	7/8 inch

Definition of measurements:

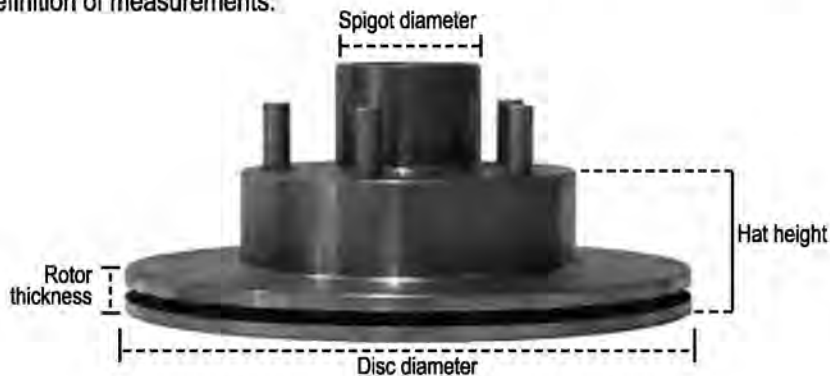

Example of Velox disc hub - its main difference is the higher hat height.

Disc hubs and rotors

9.6 inch disc hub

DH34FDUS1.8 9.6 inch (245mm) x 3/4 inch disc hub ventilated Ford stud USA 1.8t bearing



DH34FDUS1.8

10 inch disc hubs

DH12HTFG-VELOX 10 x 1/2 inch disc hub HT 5 stud slimline bearing Velox type galvanised

DH12HTG-VELOX 10 x 1/2 inch disc hub HT 5 stud LM bearing Velox type galvanised

DH58CDG-10 10 x 5/8 inch disc hub Commodore 5 stud LM bearing galvanised

DH58CDFG-10 10 x 5/8 inch disc hub Commodore 5 stud slimline bearing galvanised

DH58HQG-10 10 x 5/8 inch disc hub HQ 5 stud LM bearing galvanised

DH58HQFG-10 10 x 5/8 inch disc hub HQ 5 stud slimline bearing galvanised

DH58FDG-10 10 x 5/8 inch disc hub Ford 5 stud slimline bearing galvanised

DH58FHG-10 10 x 5/8 inch disc hub Ford 5 stud LM bearing galvanised

DH58HTG-10 10 x 5/8 inch disc hub HT 5 stud LM bearing galvanised

DH58HTFG-10 10 x 5/8 inch disc hub HT 5 stud slimline bearing galvanised

DH78FDGUS1.8 10 inch (255mm) x 7/8 inch disc hub ventilated Ford 5 stud USA 1.8t bearing



DH58FHG-10

12 inch disc hubs

DH585LFG 12 x 5/8 inch disc hub LandCruiser 5 stud slimline bearing galvanised

DH585LPG 12 x 5/8 inch disc hub LandCruiser 5 stud parallel bearing galvanised

DH58LFG 12 x 5/8 inch disc hub 6 stud slimline bearing galvanised

DH58LPG 12 x 5/8 inch disc hub 6 stud parallel bearing galvanised

DH58LTXG 12 x 5/8 inch disc hub 6 stud TX bearing galvanised

DH585LTXG 12 x 5/8 inch disc hub LandCruiser 5 stud TX bearing galvanised



DH58LTX

Disc rotors - Ventilated

K10 275mm x 24mm Ford 5 stud dacromet disc rotor ventilated



K10SS 275mm x 24mm Ford 5 stud stainless steel disc rotor ventilated



K10FDHT 275mm x 24mm Multi-drill for both Ford and HT 5 stud patterns dacromet disc rotor ventilated

K12 310mm x 24mm 6 stud dacromet disc rotor ventilated



K12SS 310mm x 24mm 6 stud stainless steel disc rotor ventilated



K12TX 310mm x 24mm 6 stud dacromet disc rotor ventilated for parallel and TX lazy hubs

K12SSTX 310mm x 24mm 6 stud stainless steel disc rotor ventilated for parallel and TX lazy hubs

K12LC5TX 310mm x 24mm LandCruiser 5 stud dacromet disc rotor ventilated for parallel and TX lazy hubs



K10



K12SS



K10FDHT

Wheel studs and nuts

SN716	7/16 inch steel wheel nut
SN716C	7/16 inch steel wheel nut chrome
SN12	1/2 inch steel wheel nut
SN12C	1/2 inch steel wheel nut chrome
SN916	9/16 inch steel wheel nut
WS716	7/16 inch wheel stud
WS12	1/2 inch wheel stud
WS12LCS	1/2 inch wheel stud short knurl
WS12LCL	1/2 inch wheel stud long knurl
WS916LCS	9/16 inch wheel stud short knurl
WS916LCL	9/16 inch wheel stud long knurl
WSM12X1.5LCS	M12 x 1.5 wheel stud short knurl
WSM14X1.5LCS	M14 x 1.5 wheel stud short knurl
WSM14X1.5LCL	M14 x 1.5 wheel stud long knurl



Long knurl studs are normally used with 2 piece drums

Wheel stud identification

Part	Thread size	Thread length	Knurl diameter	Knurl length
WS716	7/16 UNF	30mm	14mm	8.5mm
WS12	1/2 UNF	26mm	14mm	11mm
WS12LCS	1/2 UNF	36mm	16mm	11mm
WS12LCL	1/2 UNF	33mm	16mm	20mm
WS12ES	1/2 UNF	36mm	15.6mm	14.5mm
WS916LCS	9/16 UNF	32mm	15.7mm	22.3mm
WS916LCL	9/16 UNF	37.5mm	15.5mm	10.5mm
WSM12X1.5LCS	M12 x 1.5	26mm	14mm	10mm
WSM14X1.5LCS	M14 x 1.5	36mm	15.7mm	12mm
WSM14X1.5LCL	M14 x 1.5	35mm	15.7mm	18mm

Dust caps

DC2	45mm dust cap
DC2US	51mm (1.98 inch) dust cap for USA hubs 
DC2.5US	62mm (2.5 inch) dust cap for USA hubs 
DC2.5	64mm dust cap
DC3	76.5mm dust cap
DC-VELOX	Rubber dust cap for Velox style aluminium wheels



DC2



DC2.5US

Bearing protectors (bearing buddies)

BP45	45mm stainless steel bearing protector 1 pair with caps
BP51	51mm (1.98 inch) bearing protector with caps for USA hubs. 1 pair 
BP63	63mm stainless steel bearing protector . 1 pair



Replacement caps for bearing protectors

BP45CAPS	Replacement caps for BP45 Bearing protectors 1 pair
BP51C	Replacement caps for BP51 Bearing protectors 1 pair
BP63C	Replacement caps for BP63 Bearing protectors 1 pair



BP45

Brake Fluid

EGBF500	Enviro Gold Brake Fluid 500ml Bottle (Dot 4 Grade 3)
EGBF5	Enviro Gold Brake Fluid 5L Pack (Dot 4 Grade 3)
EGBF20	Enviro Gold Brake Fluid 20l Drum (Dot 4 Grade 3)



Brake drum backing plates and spares

9 inch hydraulic

- HBP90L 9 inch left hand hydraulic backing plate assembly with park brake
 HBP90R 9 inch right hand hydraulic backing plate assembly with park brake



9 inch hydraulic spares

- HBP90BS LoadForce™ 9 x 1.75 inch hydraulic brake shoe set of 4
 HBP90WC 9 inch hydraulic brakes wheel cylinder bore size 13/16 inch
 HBP90SRP 9 inch hydraulic backing plate shoe retaining pin, spring and cup
 HBP90SRS 9 inch hydraulic backing plate shoe retracting spring - bottom spring
 HBP90TS 9 inch hydraulic backing plate top spring
 HBP90BOLTKIT Nut and bolt kit for mounting one hydraulic backing plate to bracket

9 inch hydraulic backing plates require 1 x HBP90BOLTKIT bolt kit to mount to the bracket.



HBP90SRS



HBP90WC



HBP90SRP



HBP90BS



HBP90TS

Weld-on mounting plates are on page 48

9 inch mechanical

- MBP90L 9 inch left hand mechanical backing plate assembly
 MBP90R 9 inch right hand mechanical backing plate assembly



9 inch mechanical spares

- MBP90BS LoadForce™ 9 x 1.75 inch mechanical drum brake shoe set of 4
 MBP90ADJ Mechanical drum brake adjuster
 MBP90SRS 9 inch mechanical backing plate shoe retracting spring
 MBP90BOLTKIT Nut and bolt kit for mounting one mechanical backing plate to bracket
 MBP90TS Mechanical backing plate top spring

9 inch mechanical backing plates require 1 x MBP90BOLTKIT bolt kit to mount to the bracket.



MBP90ADJ



MBP90SRS

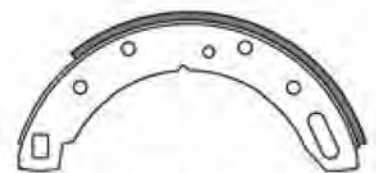

MBP90BS

Weld-on mounting plates are on page 48

10 inch electric

- EBP10L 10 inch left hand electric backing plate assembly with park brake
 EBP10R 10 inch right hand electric backing plate assembly with park brake



10 inch electric brake drum spares

- EBP10BS LoadForce™ 10 x 2.25 inch standard Australian electric brake shoe set of 4
 EBP10MOVAL 10 inch electric magnet oval 1.5amp
 EBP10MC 10 inch electric brake magnet clip
 EBP10MS Electric brake magnet spring
 EBP10MLLH 10 inch electric brake magnet lever left hand
 EBP10MLRH 10 inch electric brake magnet lever right hand
 EBP10SRP 10 inch electric shoe retaining pin, spring and cup
 EBP10SRS 10 inch electric shoe retracting spring
 EBP10SAS 10 inch electric shoe adjuster spring
 EBP10PLS 10 inch electric park brake lever spring
 EBP10PLLH 10 inch electric park lever left hand
 EBP10PLRH 10 inch electric park lever right hand
 EBP10ANS 10 inch electric adjuster nut and screw
 EBP10ASS 10 inch electric adjuster screw socket
 NN716UNF Nyloc nuts for 10 inch backing plates

10 inch electric backing plates need 4 x NN716UNF nyloc nuts to mount to the bracket.

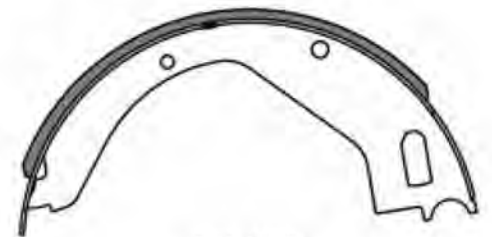

EBP10BS



EBP10MLRH

EBP10MOVAL

Off-road magnets

- EBP10MOL 10 inch electric magnet off-road left hand
 EBP10MOR 10 inch electric magnet off-road right hand



Off-road magnet



EBP10MC



EBP10ANS



EBP10ASS



EBP10PLS



EBP10SAS



EBP10SRP



EBP10SRS

12 inch electric

EBP12L	12 inch left hand electric backing plate assembly with park brake
EBP12R	12 inch right hand electric backing plate assembly with park brake



12 inch electric brake drum spares

EBP12BS	LoadForce™ 12 x 2 inch standard Australian electric brake shoes set of 4
EBP12MOVAL	12 inch electric magnet oval 3.0amp
EBP12SRS	12 inch electric shoe retracting spring
EBP12BOLTKIT	Nyloc nut and bolt kit for 12 inch backing plate
EBP12MLRH	12 inch magnet lever right hand backing plate
EBP12MLLH	12 inch magnet lever left hand backing plate
EBP10SRP	10 inch and 12 inch electric shoe retaining pin, spring and cup

12 inch electric backing plates need 1 x EBP12BOLTKIT bolt kit to mount to the bracket.

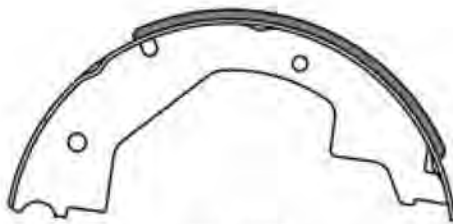

EBP12BS



EBP10SRP



EBP12SRS



EBP12MOVAL

Mounting plates for brake drum backing plates

ABH40R	Weld-on mounting plate for 40mm round axle and 9 inch hydraulic brake
ABH40S	Weld-on mounting plate for 40mm square axle and 9 inch hydraulic brake
ABH45R	Weld-on mounting plate for 45mm round axle and 9 inch hydraulic brake
ABH45S	Weld-on mounting plate for 45mm square axle and 9 inch hydraulic brake
ABE40R	Weld-on mounting plate for 40mm round axle and 9 inch mechanical or 10 inch electric brakes
ABE40S	Weld-on mounting plate for 40mm square axle and 9 inch mechanical or 10 inch electric brakes
ABE43R	Weld-on mounting plate for 43mm round electric turn axle and 10 inch electric brakes
ABE45R	Weld-on mounting plate for 45mm round axle and 9 inch mechanical or 10 inch electric brakes
ABE45S	Weld-on mounting plate for 45mm square axle and 9 inch mechanical or 10 inch electric brakes
ABE50S	Weld-on mounting plate for 50mm square axle and 9 inch mechanical or 10 inch electric brakes
ABE50S-12	Weld-on mounting plate for 50mm square axle and 12 inch electric brakes



ABE40R

Brake shoes



HBP90BS	LoadForce™ 9 x 1.75 inch hydraulic brake shoe set of 4
MBP90BS	LoadForce™ 9 x 1.75 inch mechanical drum brake shoe set of 4
EBP10BS	LoadForce™ 10 x 2.25 inch standard Australian electric brake shoe set of 4
EBP10BS-DEXTER	LoadForce™ 10 x 2.25 inch Dexter electric brake shoes set of 4
EBP12BS	LoadForce™ 12 x 2 inch standard Australian electric brake shoes set of 4
EBP12BS-DEXTER	LoadForce™ 12 x 2 inch Dexter electric brake shoe set of 4



MBP90BS



EBP10BS



EBP12BS



HBP90BS



EBP10BS-DEXTER



EBP12BS-DEXTER

Be aware there are many different Dexter shoes please check profile picture.



Brake calipers and spares *All calipers come with brake pads.*

A100 Mechanical caliper

A100 Mechanical galvanised cast iron caliper. Fits on 1/2 inch up to 5/8 inch disc. 2x A100BOLT bolts required for mounting. Includes brake pads.



Spare parts for A100 caliper

DPT LoadForce™ A100 mechanical disc pad set of 4 (also suits Trigg hydraulic A200, Ark and Alko mechanical caliper, Meher)
 A100BOLT Bolt to mount A100 mechanical caliper (also suits A200 hydraulic caliper)
 A101 Caliper arm - straight for A100 mechanical caliper
 A102 T-pad galvanised for A100 mechanical caliper
 A103 Caliper arm - 90 degree for A100 mechanical caliper
 SPRSS100 Stainless return spring for A100 mechanical caliper
 SSA-M Stainless slide tube for ARK and Alko mechanical 42mm length x 17mm diameter (1 pair)
 SSTH-M Stainless slide tube for Trigg mechanical and hydraulic 38mm length x 19mm diameter (1 pair)



DPT



SSTH-M

A103

A101

A102

A100BOLT

SPRSS100

Caliper mounting brackets are on page 54

A200 Hydraulic calipers

A200 A200 hydraulic galvanised cast iron caliper. Fits on 1/2 inch up to 5/8 inch disc.*
 2x A100BOLT bolts required for mounting.
 Includes brake pads. (Trigg style)



**HU4 union and CWI copper washer are required for installation of A200 calipers*

Spare parts for A200 caliper

DPT LoadForce™ A200 hydraulic disc pad set of 4 (also suits mechanical A100, Ark and Alko mechanical caliper, Meher)
 A100BOLT Bolt to mount A200 hydraulic caliper (also suits A100 mechanical caliper)
 SSTH-M Stainless slide tube 38 x 19mm for Trigg mechanical and hydraulic (1 pair)
 A200OR Piston O-ring for Trigg A200 caliper
 A202 Stainless steel piston for Trigg A200
 BS1 Stainless steel bleeder screw for Trigg A200

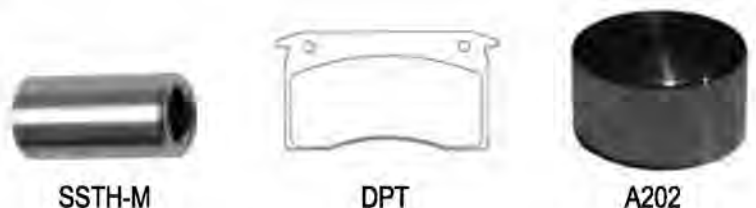

SSTH-M

DPT

A202

TA300 hydraulic caliper

All calipers come with brake pads.

- TA300 TA300 hydraulic galvanised cast iron caliper. Fits on 1/2 inch up to 5/8 inch disc.*
Designed to be a replacement for the A200 caliper.
1x TA300BOLTKIT required for mounting.
- TA300-SS TA300 stainless steel brake caliper. Fits on 1/2 inch up to 5/8 inch disc.*
1x TA300BOLTKIT required for mounting.

*HU4 union and CW1 copper washer are required for installation of TA300, TA300-SS calipers



Spare parts for TA300 caliper

- DPTA300 LoadForce™ TA300 caliper disc pad set of 4 (also suits Alko AL400 caliper, Meher, Trojan)
- TA300BOLTKIT Bolt kit to mount TA300 caliper contains 2 bolts and washers
- SPTA300 Slide pin kit for TA300 caliper (1 pair)
- CKTA300 Seal kit for Trojan TA300 caliper includes all rubber components (also suits Alko AL400)
- CPTA300-SS Stainless steel piston for Trojan TA300 hydraulic caliper (also suits Alko AL400)
- BS38X24TPI Bleed screw for TA300 caliper

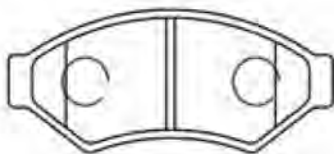

DPTA300



SPTA300



BS38X24TPI



CKTA300



CPTA300-SS

Caliper mounting brackets are on page 54

AL400 hydraulic caliper

All calipers come with brake pads.

- AL400 AL400 hydraulic galvanised cast iron brake caliper. Fits on 1/2 inch up to 5/8 inch disc. Comes with mounting bolts. Trojan, MK7, Alko and Meher style.



Spare parts for AL400 caliper

- DPTA300 LoadForce™ AL400 hydraulic caliper disc pad set of 4 (also suits TA300 caliper, Meher)
- CKTA300 Seal kit for AL400 and Alko caliper includes all rubber components (also suits TA300)
- CPTA300-SS Stainless steel piston for AL400 and Alko hydraulic caliper (also suits TA300)
- SPAL400 Slide pin kit brass with bolts for AL400 and Alko caliper. Replaces original stainless slides with acorn nuts



DPTA300



CPTA300-SS



CKTA300



SPAL400

UFP DB35 brake calipers

All calipers come with brake pads.



- DB35-A UFP DB35 aluminium brake caliper. Fits on 19mm (3/4 inch) up to 24mm disc. 1 x UFPBOLTKIT required for mounting
- DB35-SS UFP DB35 stainless steel brake caliper. Fits on 19mm (3/4 inch) up to 24mm disc. 1 x UFPBOLTKIT required for mounting
- DB35-PB-L UFP DB35 brake caliper left side with park brake. Fits on 19mm (3/4inch) up to 24mm disc. 1 x UFPBOLTKIT required for mounting
- DB35-PB-R UFP DB35 brake caliper right side with park brake. Fits on 19mm (3/4 inch) up to 24mm disc. 1 x UFPBOLTKIT required for mounting



DB35-A



DB35-PB-L

Spare parts for UFP DB35 and UFP Park Brake caliper

- DPUFP35 LoadForce™ UFP35 caliper disc pad set of 4
- DPUFP35-PB LoadForce™ UFP35 park brake caliper Disc pad set of 4
- CKUFP35 Seal kit for UFP35 caliper
- CPUFP35 Stainless steel piston for UFP35 caliper
- UFPBOLTKIT Bolt kit for mounting UFP caliper
- CKUFP35-PB Seal kit for UFP35-PB park brake caliper
- BSUFP35 Bleed screw for DB35
- SSUFP35 Stainless steel slide pin for UFP35 caliper (1 pair)
- WCUFP35 Wire anti-rattle clip for DB35



CPUFP35



CKUFP35-PB

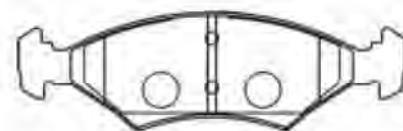

DPUFP35

Caliper mounting brackets are on page 54

Spare parts for UFP42 caliper



- CKUFP42 Seal kit for UFP42 caliper
- DPUFP42 LoadForce™ UFP42 caliper disc pad set of 4

Kodiak 225 calipers

All calipers come with brake pads. 

- DBC-225-DAC Kodiak 225 dacromet brake caliper. Fits on 19mm (3/4 inch) up to 24mm disc
- DBC-225-SS Kodiak 225 stainless steel brake caliper. Fits on 19mm (3/4 inch) up to 24mm disc



Spare parts for Kodiak 225 caliper

- DPK225 LoadForce™ Kodiak 225 disc pad set of 4
- CKK225 Seal kit includes all rubber components for Kodiak 225 caliper
- CPK225 Stainless steel piston for Kodiak 225 caliper
- SPK225 Stainless slide pin bolts pair for Kodiak 225 caliper
- BSK225 Brass bleeder screw for Kodiak 225 caliper
- HU15 Hydraulic 90° union for Kodiak 225 caliper



BSK225



HU15



CKK225



CPK225

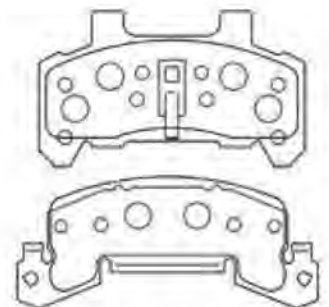

DPK225

Caliper mounting brackets are on page 54

Tiedown 46304 caliper

All calipers come with brake pads.

- 46304 Tiedown 46304 aluminium brake caliper suits ventilated rotors. Mounting bolts not included.



Spare parts for Tiedown 46304 caliper

- DPTD LoadForce™ Tiedown 46304 caliper disc pad set of 4
- CKTD Piston seal kit for Tiedown 46304 caliper
- CPTD Stainless steel piston for Tiedown 46304 caliper
- SPTD Slide pin bolts pair for Tiedown 46304 caliper

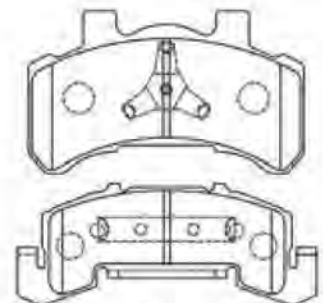

DPTD

Spare parts for Dexter 6K-8K caliper



- CKD4 Seal kit for Dexter 6K & 8K caliper
- DPD4 LoadForce™ Dexter 6K & 8K caliper disc pad set of 4

Spare parts for PBR calipers

BS10X1-L	Brass bleeder screw long 10x1mm (38mm) for PBR caliper
BS10X1-S	Brass bleeder screw short 10x1mm (33mm) for PBR caliper
CKPBR1	Seal kit for PBR type 1 caliper
CKPBR2	Seal kit for PBR type 2 caliper
CPPBR1	Stainless steel piston for PBR type 1 caliper
CPPBR2	Stainless steel piston for PBR type 2 caliper
SPPBR	Stainless slide pins pair for PBR Type 1 and Type 2 calipers
HU5-M10	Brass union for PBR Type 1 and Type 2 calipers
CW1	Copper washer for HU5-M10 union



CKPBR2



CPPBR2



BS10X1-S



CPPBR1



CW1



HU5-M10

Caliper mounting brackets

ABT40-10	Mounting bracket for A100, A200, TA300 calipers to 40mm square axle and 10 inch discs
ABT45-10	Mounting bracket for A100, A200, TA300 calipers to 45mm square axle and 10 inch discs
ABT45-12	Mounting bracket for A100, A200, TA300 calipers to 45mm square axle and 12 inch discs
ABT50-12	Mounting bracket for A100, A200, TA300 calipers to 50mm square axle and 12 inch discs
ABAL400-10-40	Mounting bracket for AL400 caliper to 40mm square axle and 10 inch discs
ABAL400-12-45	Mounting bracket for AL400 caliper to 45mm square axle and 12 inch discs
ABAL400-12-50	Mounting bracket for AL400 caliper to 50mm square axle and 12 inch discs
ABUFP40-10	Mounting bracket for UFP35 caliper to 40mm square axle and 10 inch discs
ABUFP45-10	Mounting bracket for UFP35 caliper to 45mm square axle and 10 inch disc
ABUFP50-10	Mounting bracket for UFP35 caliper to 50mm square axle and 10 inch disc
ABUFP45-12	Mounting bracket for UFP35 caliper to 45mm square axle and 12 inch disc
ABUFP50-12	Mounting bracket for UFP35 caliper to 50mm square axle and 12 inch disc
ABK10-40	Mounting bracket for Kodiak 225 caliper to 40mm square axle and 10 inch disc
ABK10-45	Mounting bracket for Kodiak 225 caliper to 45mm square axle and 10 inch disc
ABK10-50	Mounting bracket for Kodiak 225 caliper to 50mm square axle and 10 inch disc
ABK12-45	Mounting bracket for Kodiak 225 caliper to 45mm square axle and 12 inch disc
ABK12-50	Mounting bracket for Kodiak 225 caliper to 50mm square axle and 12 inch disc
ABPBR2-10-45	Mounting bracket for PBR type 2 caliper to 45mm square axle and 10 inch disc
ABPBR2-12-45	Mounting bracket for PBR type 2 caliper to 45mm square axle and 12 inch disc
ABPBR2-12-50	Mounting bracket for PBR type 2 caliper to 50mm square axle and 12 inch disc



ABT40-10



ABAL400-10-40



ABUFP50-12



ABK12-50



ABPBR2-12-50

Disc pads

DPT	LoadForce™ A100 mechanical and A200 hydraulic caliper disc pad set of 4
DPTA300	LoadForce™ TA300, Trojan, AL400 caliper, Meher disc pad set of 4
DPPBR1	LoadForce™ PBR type 1 caliper disc pad set of 4
DPPBR2	LoadForce™ PBR type 2 caliper disc pad set of 4
DPK225	LoadForce™ Kodiak 225 caliper disc pad set of 4
DPUFP35	LoadForce™ UFP35 caliper disc pad set of 4
DPUFP35-PB	LoadForce™ UFP35 park brake caliper disc pad set of 4
DPUFP42	LoadForce™ UFP42 caliper disc pad set of 4
DPTD	LoadForce™ Tie down 46304 caliper disc pad set of 4
DPDMX	LoadForce™ Deemaxx caliper disc pad set of 4
DPD4	LoadForce™ Dexter 6k-8k caliper disc pad set of 4

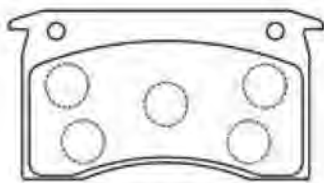

DPT

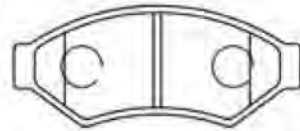

DPTA300



DPUFP35



DPPBR1

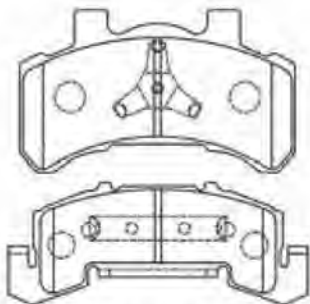

DPTD

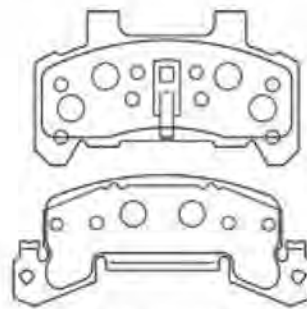

DPK225

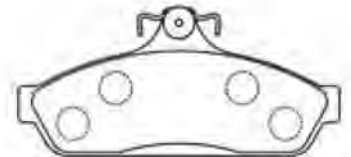

DPPBR2

Marine series disc pads

with stainless steel backing plate and ceramic material.

MDPT	LoadForce™ Marine series A100 mechanical and A200 hydraulic caliper disc pad set of 4
MDPTA300	LoadForce™ Marine series TA300, Trojan, AL400, Alko, Meher disc pad set of 4
MDPPBR2	LoadForce™ Marine series PBR Type 2 caliper disc pad set of 4
MDPK225	LoadForce™ Marine series Kodiak 225 caliper disc pad set of 4
MDPUFP35	LoadForce™ Marine series UFP35 caliper disc pad set of 4



HydraLine™

HydraLine™ is flexible stainless steel braided brake hose which outlasts conventional steel brake tubing due to its durable material in harsh environments. It is made from braided stainless steel and stainless fittings with a hardened Teflon inner tube that limits the chance of swelling under hydraulic pressure compared to conventional rubber brake line. Comes with a 1 year limited warranty. Meets Australian and International standards SAE1401J. Also complies to USA DOT standards.

Quicker to fit up, with no flaring required on tubing, HydraLine™ takes about 1/5th of the time to fit in comparison to conventional brake tubing. There are also less joins than conventional steel brake tubing, adding to the strength and durability.

HydraLine™ comes in straight fittings for lead lines, for the length of the trailer, and right angle fittings to fit into calipers. The HydraLine™ fittings have flared ends for fitting into the inverted flare in either a brass 3 way Tee piece or the union in the caliper. Calipers should be supplied with their own union, however if your caliper does not have this you will need to purchase one for the HydraLine™ to lock into the caliper correctly.

HydraLine™ can be installed in two ways:

- by sliding the flexible line up the box section of the trailer and pulling through holes where required. This is not only a neater finish to the trailer, but also means the brake line is protected inside the trailer.
- utilising stainless steel P clips to fasten the HydraLine™ to the I beam, box or C section of the trailer. See page 60.



HYDRALINE

Flexible Stainless Steel Braided Brake Line

Single axle HydraLine™ brake line kits

HL2500-1 Single axle HydraLine kit with 2500mm lead line. Suits most camper/box trailers.

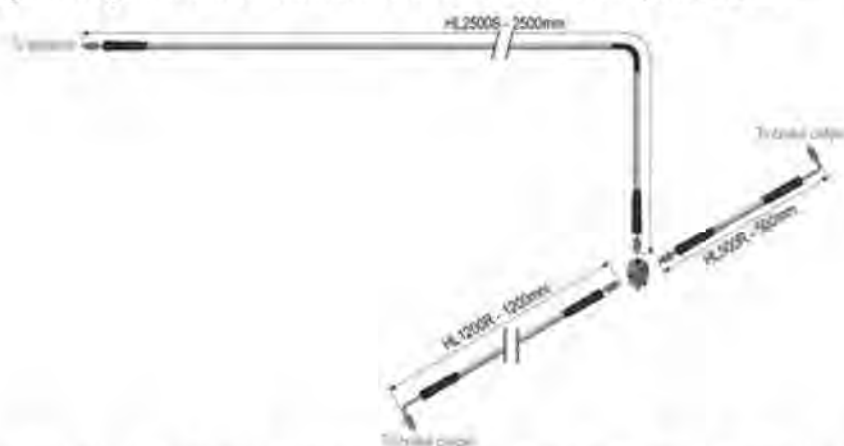

HL3500-1 Single axle HydraLine kit with 3500mm lead line. Suits most boat and large camper/box trailers.



HL4500-1 Single axle HydraLine kit with 4500mm lead line for boat trailers up to 7.0 metres (23ft).

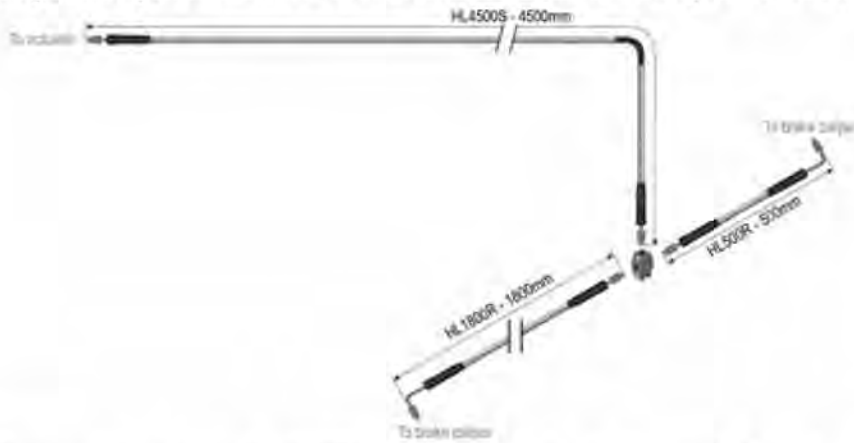

HL5500-1 Single axle HydraLine kit with 5500mm lead line for boat trailers up to 7.0 metres (23ft).

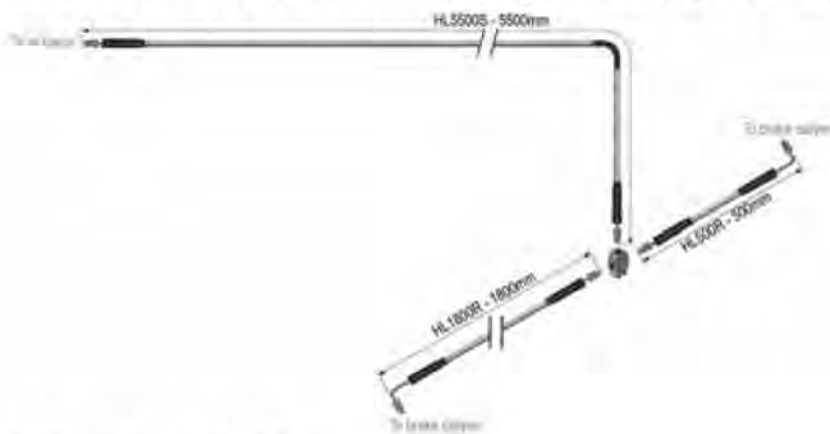

Tandem axle HydraLine™ brake line kits

HL2500-2 Tandem axle HydraLine kit with 2500mm lead line. Suits most camper/box trailers.

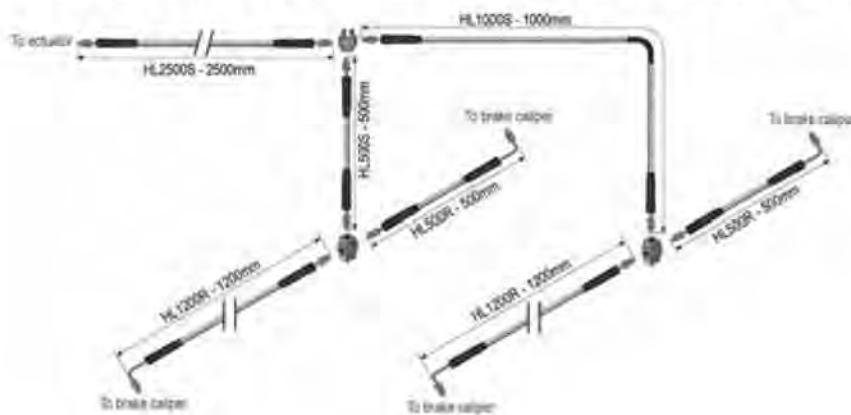

HL3500-2 Tandem axle HydraLine kit with 3500mm lead line for boat trailers up to 6.0 metres (20ft).

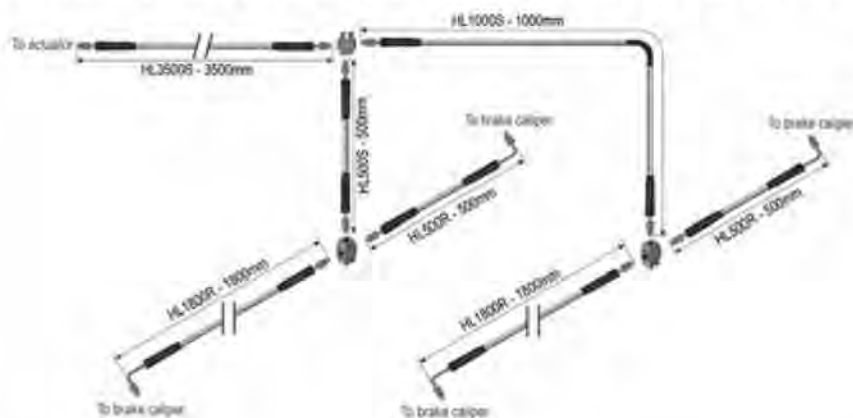

HL4500-2

Tandem axle HydraLine kit with 4500mm lead line for boat trailers up to 7.0 metres (23ft).

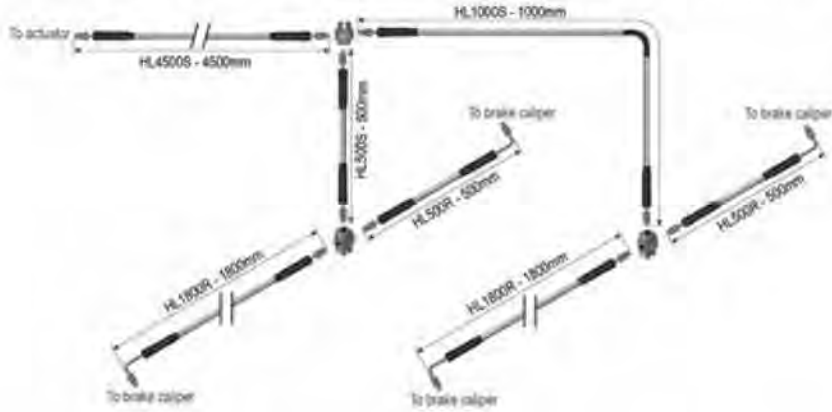

HL5500-2

Tandem axle HydraLine kit with 5500mm lead line for boat trailers up to 7.0 metres (23ft).

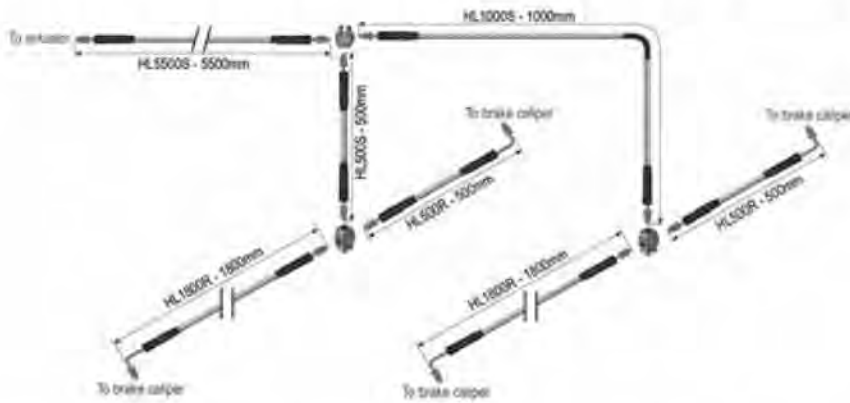

HL6500-2

Tandem axle HydraLine kit with 6500mm lead line for boat trailers up to 8.0 metres (26ft).

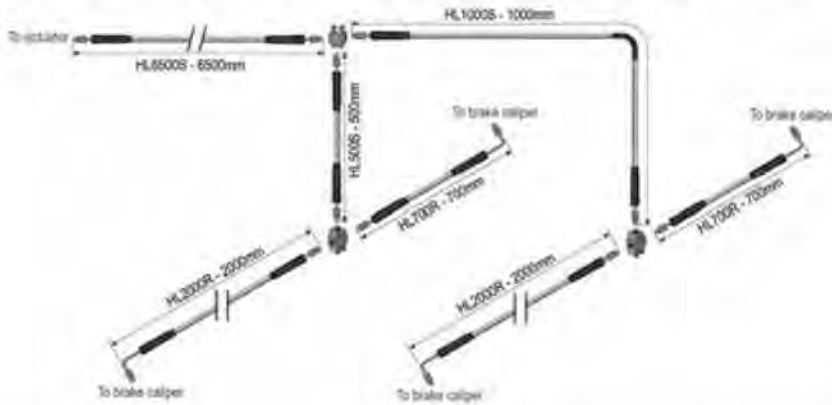

HL7500-2

Tandem axle HydraLine kit with 7500mm lead line for boat trailers up to 9.0 metres (30ft).

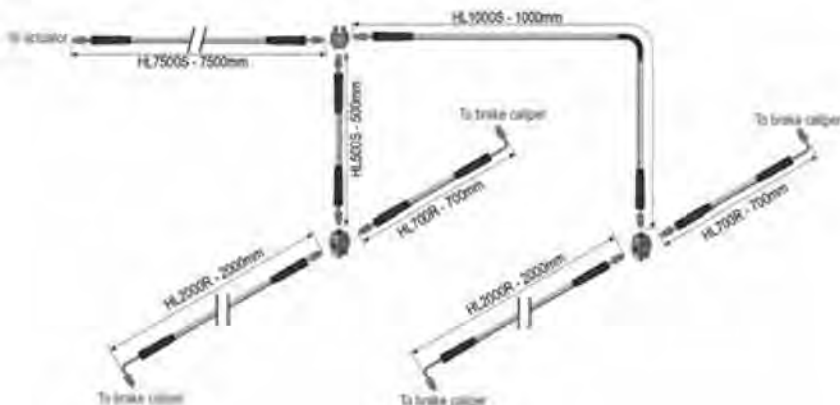

Tri-axle HydraLine™ brake line kits

HL5500-3 Tri-axle HydraLine kit with 5500mm lead line for boat trailers up to 7.0 metres (23ft).

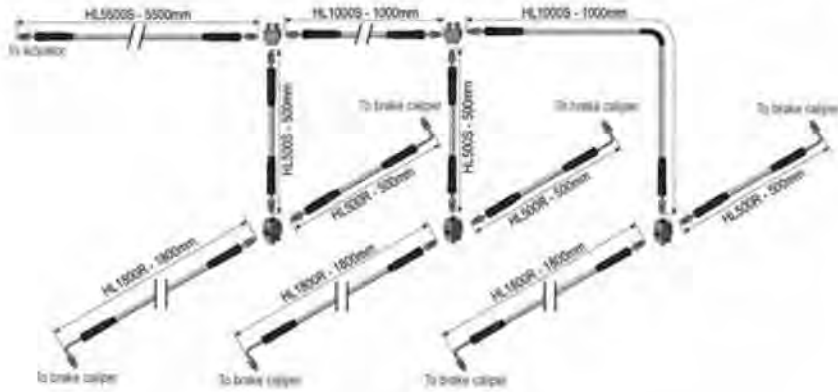

HL6500-3 Tri-axle HydraLine kit with 6500mm lead line for boat trailers up to 8.0 metres (26ft).

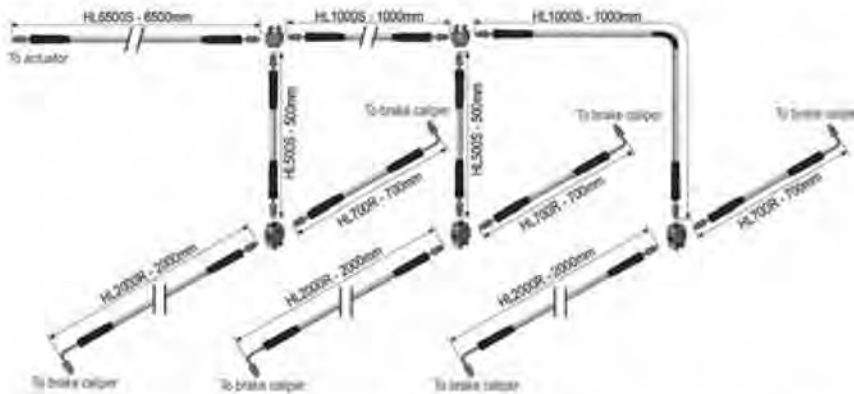

HL7500-3 Tri-axle HydraLine kit with 7500mm lead line for boat trailers up to 9.0 metres (30ft).

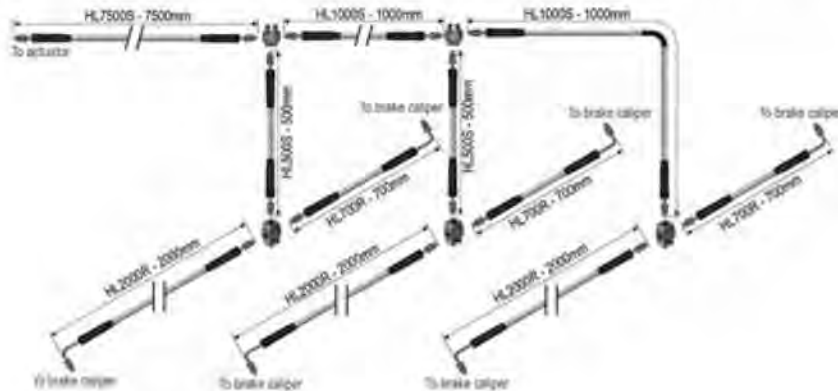

HYDRALINE

Flexible Stainless Steel Braided Brake Line

HydraLine™ is a registered trademark of Direct Source Australia Pty Ltd, parent company to Trailer Spares Direct. Genuine HydraLine products are stamped with the HydraLine brand.

HydraLine™ brake hoses

HL500R	500mm HydraLine brake hose with 90 degree bend
HL500S	500mm HydraLine brake hose
HL700R	700mm HydraLine brake hose with 90 degree bend
HL1000S	1000mm HydraLine brake hose
HL1200R	1200mm HydraLine brake hose with 90 degree bend
HL1800R	1800mm HydraLine brake hose with 90 degree bend
HL2000R	2000mm HydraLine brake hose with 90 degree bend
HL2500S	2500mm HydraLine brake hose
HL3500S	3500mm HydraLine brake hose
HL4500S	4500mm HydraLine brake hose
HL5500S	5500mm HydraLine brake hose
HL6500S	6500mm HydraLine brake hose
HL7500S	7500mm HydraLine brake hose
HL8500S	8500mm HydraLine brake hose



Associated brake hose fittings

PCSS14	1/4 inch stainless steel P clip Pack quantity 10 for hanging the HydraLine brake hose to the chassis
HU2	2 way brass joiner suit 3/16 inch tube
HU3	3 way brass tee suit 3/16 inch tube



All calipers should be supplied with their own brake line union.
If you do not have this union, please purchase:

HU4 for Trojan, Alko, Meher, Trigg and Ark calipers

HU5-M10 for PBR type 1 and 2 calipers.

CW1 Copper washer is required for use with both HU4 and HU5.



HU4



HU5-M10



CW1

Brake tube and fittings

CW1	Copper washer
HBV	Hydraulic shut off handbrake valve allows 2 hydraulic systems to operate on the same line
HU1-10	10 x 1mm zinc plated tube nut
HU1-3/8	3/8 inch 24tpi brass tube nut
HU1-3/8SS	3/8 inch 24tpi stainless steel tube nut
HU2	2 way brass joiner suit 3/16 inch tube
HU3	3 way brass tee for 3/16 inch tube
HU4	Brass hydraulic union for trailer override master cylinder and for Trigg and Alko calipers
HU5-M10	3/8 inch 24tpi M10x1 hydraulic union to suit PBR calipers
HU15	90° hydraulic union for Kodiak 225 calipers
PCSS14	1/4 inch stainless steel P clip. Pack quantity 10



HBV



HU3



HU1-3/8SS



HU4



HU15



HU5-M10

Brake cables, adjusters and fittings

BC7	7m brake cable wire kit 4mm wire with 4 x 4mm clamps
BC10	10m brake cable wire kit 4mm wire with 4 x 4mm clamps
BCP	Brake cable pulley and adjuster
BCGP	Brake cable guide pulley
CC4	Cable clamp 4mm galvanised
BCPBOLTKIT	Bolt kit for installation of BCP



BCGP



BC10



BCP



CC4

Brake specialist tools

2424	Brake spring tool
2314-T	Double ended brake shoe retaining cup spring tool
2033	3.5 inch (90mm) brake adjusting tool
72530JUT	Flaring kit 7 piece double ended 3/16 - 1 inch



2424



2033



2314-T

HYDRASTAR BRAKE ACTUATOR

Hydrastar brake actuators

In Australia, if you are towing a trailer weighing more than 2 tonnes, you are required to have a braking system fitted to the trailer including a breakaway system to ensure your trailer can stop if it separates from the tow vehicle. You must also be able to override the brakes from the driver's seat, by using an in-cab controller.

Compatible with the largest range of in car controllers

The driver must be able to control the brakes from the driver's seat. One of the advantages of the Hydrastar over other systems, is its ability to be used with a wide range of controllers. It is also the only actuator that is directly compatible with the more advanced in-cab brake controllers, such as the Tekonsha Prodigy P2 and P3. A full listing of brake controllers that have been tested by the manufacturers of Hydrastar are available on our website, it lists whether these are compatible or not.

Quality brand you can trust

Hydrastar HBA Series is the leading braking system on the market. For over 15 years Hydrastar has been the most popular choice for trailer brake actuators and is still the best on the market today.

The Hydrastar eliminates the brake drag common with surge actuators on downhill grades and also works easily in reverse. It is easy to operate; the trailer brakes engage when the tow vehicle brake pedal is applied or overridden by an in-cab controller.

Product selection

Hydrastar units are available in 1000 psi for trailers up to 3 tonne with drum or disc brakes, 1200 psi for trailers up to 3.5 tonne with disc brakes and 1600 psi unit for those larger trailers greater than 3.5 tonne with disc brakes.

A battery and breakaway kit are required to complete the Hydrastar package. The breakaway switch is fitted to both the trailer and the tow vehicle ensuring that should the trailer become separated from the tow vehicle, the breakaway switch is activated and the trailer brakes are applied.

2 Year Warranty

Hydrastar HBA Series comes with a 2 year warranty for peace of mind. We are authorised for warranty repairs and servicing, so you know if you buy from us, we can help should you need it. We also stock a range of spare parts for servicing needs.

381-7065	Hydrastar HBA10 1000psi for trailers up to 3t with drum or disc brake applications
381-7066	Hydrastar HBA12 1200psi gen7 for trailers up to 3.5t with disc brake applications
381-7067	Hydrastar HBA16 1600psi gen7 for trailers over 3.5t with disc brake applications



Maintenance on Hydrastar units

We recommend the use of Dot 4 brake fluid in the Hydrastar units. Regular maintenance should be carried out to increase the longevity of the unit. Bleeding of the full brake system should be carried out regularly from the Hydrastar unit right through to the calipers to ensure the full hydraulic system is clear of any grit that can damage the mechanisms of the unit.

Hydrastar spares

HBASK	Hydrastar gasket and seal kit
496-200	Hydrastar circuit board
275-7007	Hydrastar hydraulic pump cartridge
32-7640	Hydrastar reservoir cap
496-173	Solenoid coil assembly
496-183	Hydrastar electric motor
192-7088	1/2 inch connector nut
192-7089	Hydrastar union
394-54	Hydrastar valve solenoid
43-9002	T25 screw for Hydrastar
43-8986	Hex head bolt for Hydrastar electric motor
43-9020	Hydrastar filter screen and inlet tube
75-1029	Hydrastar manifold hydraulic
75-1030	Hydrastar tank housing
84-35	Hydrastar bleeder valve screw
93-8226	Hydrastar end plate
93-8227	Hydrastar end plate 90 degree bracket



HBASK



496-200



496-173



496-183



32-7640

Wiring diagram for the Hydrastar unit

This wiring diagram is in the installation instructions that come with the Hydrastar unit.

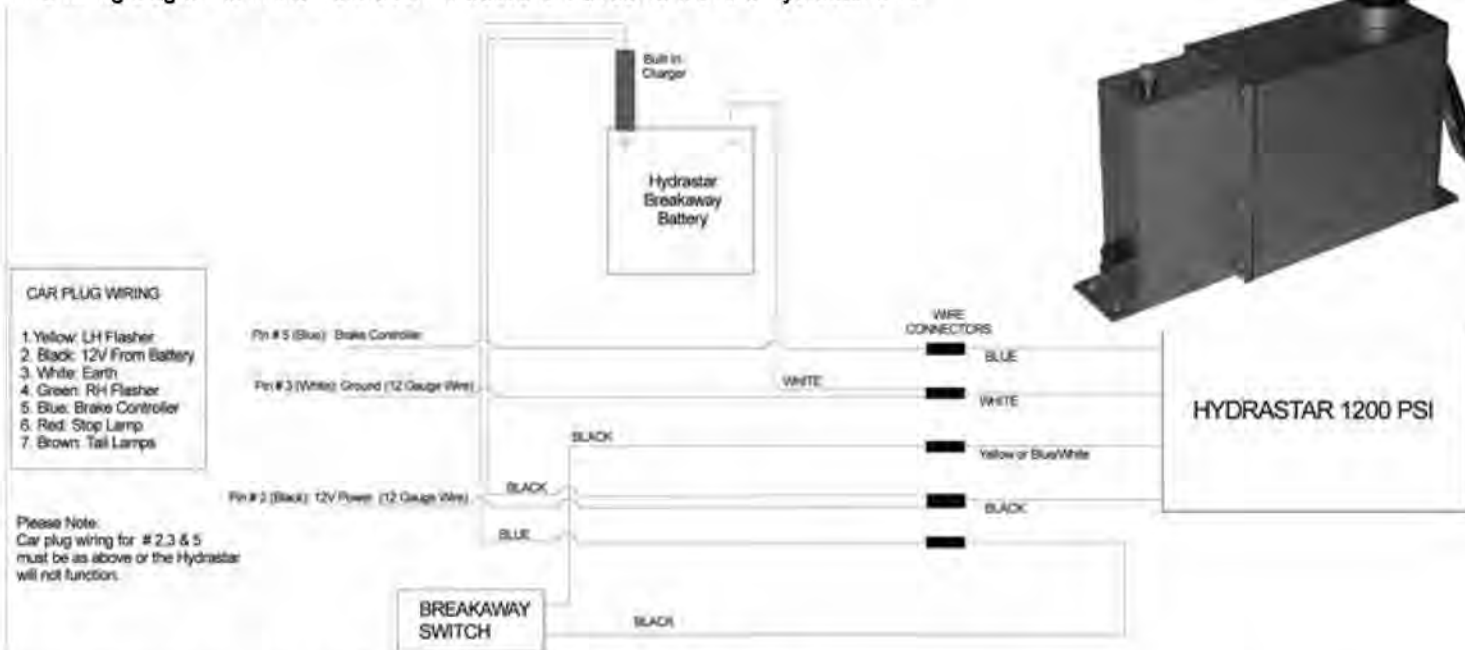

Some common mistakes to avoid during installation of the unit.

- The power (black) wire from the car's battery to the car's socket in pin no. 2 (reverse) **must be** at least a 6mm gauge wire. The same gauge wire (6mm), must be used from the trailer plug pin no. 2 to the Hydrastar.
- The brake (blue) wire from the brake controller to the car's socket in pin no. 5 (service brakes) **must be** at least a 5mm gauge wire. The same gauge wire (5mm) must be used from the trailer plug pin no. 5 to the Hydrastar.

Note: the blue and black wires in the 7 core trailer wire are not heavy enough a gauge wire to power the unit properly.

Batteries and breakaway

- 50-85-312 5amp breakaway kit for use with Hydrastar and 12v electric drum brakes
- 2005-P Breakaway switch
- 496-BAT 5 amp battery only
- 50-85-104 Breakaway battery maintainer diode
- 50-85-201 Replacement battery box only for 5 amp
- H05000 Hayman Reese Smartcheck wireless battery monitor allows remote monitoring of the charge of up to four batteries located in the vehicle or the trailer.



50-85-312



2005-P



50-85-104



50-85-201



H05000



496-BAT

IQ7 brake actuator

- 355002E IQ7 Electric hydraulic brake actuator contains a compressed air chamber for stopping performance. Maximum pressure is 1000psi. Built-in breakaway system activates if the trailer and tow vehicle are separated. Can be used with existing brake controllers. Comes with a 3 year warranty (When installed by an authorised AL-KO iQ7 installer).





Draw bar brake controller

- DBC 12V electric brake controller for mounting on draw bar.
 - Dial on unit for adjusting braking power.
 - Suitable for trailers with one braked axle under 2000kg ATM.

**The draw bar controller is not compatible with the Hydrastar.*



In cab brake controllers - proportional

- 90195 **Tekonsha P3 brake controller**
P3 is the industry's most advanced electric trailer brake control. Features include:
- 5 storable setting options for pulling different trailers or for setting preferences of multiple drivers.
 - Switch between Electric brakes and Electric over Hydraulic applications.
 - Distinct, easy to see LCD display with multiple colour and contrast options
 - Highly advanced, easy-to-understand, roadside diagnostics
 - Easy access, "Up-Front" controls
 - A "flashing red" warning system alerts user to "No Trailer Brake" situations
 - Snap-in mounting clip allows user to remove and store the controller when not in use
 - Limited lifetime warranty
- 
- 90885 **Tekonsha Prodigy P2 controller**
- Reverse battery protection for both vehicle and breakaway
 - Designed to work with electronic over hydraulic brake systems
 - Electric trailer brake control for up to 4 braking axles
 - Numerous mounting options - including 360 degree vertical rotation
 - "Boost" feature gives users the ability to apply more initial trailer braking power when towing heavier trailers
 - Continual diagnostics check for proper connection, shorted magnet conditions and more
 - Quick and easy disconnect feature allows user to remove and store the controller when not in use
 - Limited lifetime warranty
- 
- 90160 **Tekonsha Primus IQ controller***
- Electric trailer brake control for up to 3 braking axles
 - Self-diagnostics features will illuminate LED readout when issues occur.
 - Easy-to-set system allows the driver maximum flexibility when determining how the trailer should respond to a braking event.
 - Diagnostic features incorporated in LED display
 - Snap-in mounting clip allows user to remove and store the controller when not in use
 - Limited Lifetime Warranty
- *The primus IQ controller is not compatible with the Hydrastar unit.*
- 
- 9030 **Tekonsha Voyager controller**
- Broad control range makes setting quick and easy
 - As braking power is applied, the LED changes colour gradually from green (completed circuit) to red, to indicate relative braking power
 - Minimises false braking for smoother ride
 - Electric trailer brake control for up to 4 braking axles
 - 5 year limited warranty
- 
- H06000 **Hayman Reese CompactIQ™ proportional brake controller**
- Dial and LED indicator can be mounted in a spare switch panel.
 - Includes a "boost" feature to apply more or less braking when needed
 - LED indicator shows the status of braking system
 - Compatible with Electronic Stability Control systems
 - Electric trailer brake control for single, tandem and tri- braking axles
 - 3 year warranty
- 

Brake wiring kit required for installation of controllers are on page 66

Brake controller spares

- 5901 Cradle to suit Tekonsha P3
- 7686 Cradle to suit Tekonsha Prodigy P2
- 7894 Harness to suit Tekonsha Voyager, Primus, Prodigy P2, P3 and Hayman Reese CompactIQ



5901



7894

You don't need to buy 2 separate controllers for use in 2 vehicles. Just buy an extra wiring kit, a harness and a cradle. Move the controller between the vehicles.

Brake controller installation kits

- BCWK Brake controller wire kit (multi-fit up to 30 amp) for trailers up to tri-axle. Includes 7.5m each of 6mm black and 5mm blue wire, connectors and circuit breakers.



Wiring diagram for the in-cab controller

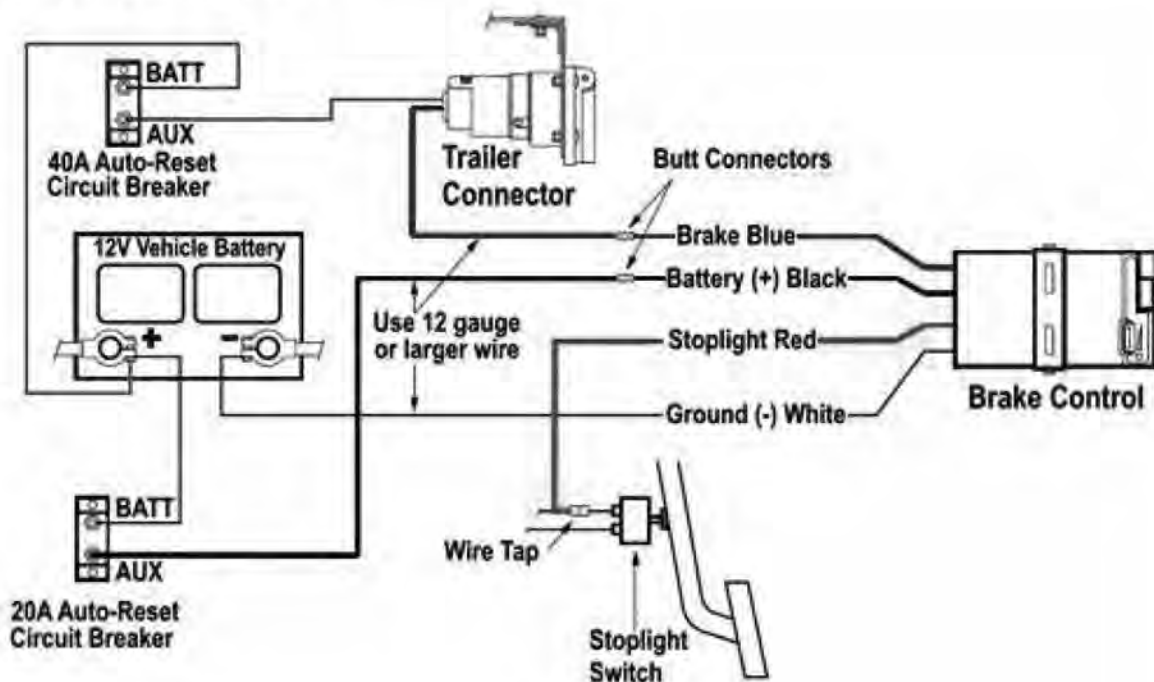

Brake kits – single, tandem and tri-axle

Whether you are building a new trailer, converting or upgrading the brakes on your existing trailer, the brake kit includes couplings and all braking components. Disc hub or drum hub assembly are not included due to the variety of options of stud and bearing combinations.

We have a kit suitable for all trailers up to 4.5 tonne including caravans, campers, box, multi-purpose and boat trailers with the following brake options:

- mechanical override brakes
- mechanical drum brakes
- hydraulic override brakes
- hydraulic disc brakes.

Determining the right braking system for your trailer depends on the trailer application, the aggregate trailer mass (ATM) of your trailer and the wheel size.

The ADR guidelines* for braking requirements on trailers are:

(*guidelines supplied as a guide only. ADR's are available from the Government website)

ATM (aggregate trailer mass) Braking requirements

Up to 750kg No brakes are required

750kg – 2000kg At least one axle must be braked.

2000kg – 4500kg All wheels must be braked, all trailers must be fitted with a breakaway system that applies the brakes for minimum 15mins if the trailer is separated from the tow vehicle.

Mechanical override marinised disc brake kit

TBKM-1 Trailer brake kit mechanical disc single axle for 10 inch or 12 inch x 1/2 inch to 3/4 inch discs

The kit includes:

- 1 x A800 override coupling and 4 x coupling bolts
- 1 x Handbrake lever
- 1 x BCP Brake cable pulley and the nut and bolt required for installation
- 1 x BC7 Brake cable kit includes 7m of wire and 4 cable clamps.
- 2 x A100 calipers and 4 x A100 Bolts
- 2 x Caliper brackets to suit A100. Disc type and axle size required.



TBKM-2

Trailer brake kit mechanical disc tandem axle for 10 inch or 12 inch x 1/2 inch to 3/4 inch discs

The kit includes:

- 1 x A800 override coupling and 4 x coupling bolts
- 1 x Handbrake lever
- 1 x BCP Brake cable pulley and the nut and bolt required for installation
- 1 x BC10 Brake cable kit including 10m of wire and 4 cable clamps.
- 4 x A100 calipers and 8 x A100 bolts
- 4 x Caliper brackets to suit A100. Disc type and axle size required.



Single axle hydraulic override marinised disc brake kit

TBKHO1-1

Trailer brake kit hydraulic override single axle for 10 inch discs

The kit includes:

- 1 x A800 override coupling and 4 x coupling bolts
- 1 x A803Z handbrake lever
- 1 x MC34 master cylinder, including copper washer, hydraulic union and nuts and bolts for installation
- 1 x HydraLine kit - for the size, we need your measurement from coupling to the axle
- 2 x TA300 Hydraulic galvanised calipers
- 2 x Caliper brackets suit TA300. Disc type and axle size required.
- 1 x 500ml Enviro Gold Brake Fluid



Mechanical drum brake kit

TBKMD-1

Trailer brake kit mechanical drum single axle

Kit includes:

- 1 x A800 override coupling and 4 x coupling bolts to mount
- 1 x A807 handbrake lever
- 1 x BCP Brake cable pulley and the nut and bolt required for installation
- 1 x BC7 Brake cable kit including 7m of wire and 4 cable clamps
- 1 x MBP90R 9 inch Mechanical backing plate assembly right
- 1 x MBP90L 9 inch Mechanical backing plate assembly left
- 2 x Axle weld-on brake mounting plate to suit 9 inch mechanical drum and axle size
- 2 x MBP90BOLTKIT bolt kit for mounting backing plates.



Tandem trailer electric/hydraulic brake kit

TBKHT2-2-1200

Trailer brake kit electric/hydraulic marinised tandem axle for 10 inch or 12 inch x 5/8 inch to 7/8 inch discs

Kit includes:

- 1 x Hydrastar HBA12 1200psi unit with 2 year warranty
- 1 x Battery breakaway kit 5amp 12v
- 1 x HydraLine kit – for the size, we need your measurement from Hydrastar to the first axle
- 4 x DB35-A UFP aluminium hydraulic brake calipers
- 4 x Axle caliper brackets to suit DB35 UFP calipers. Disc type and axle size required.
- 4 x Bolts to suit UFP DB35 calipers
- 2 x 500ml Enviro Gold Brake Fluid, Dot 4 grade 3.

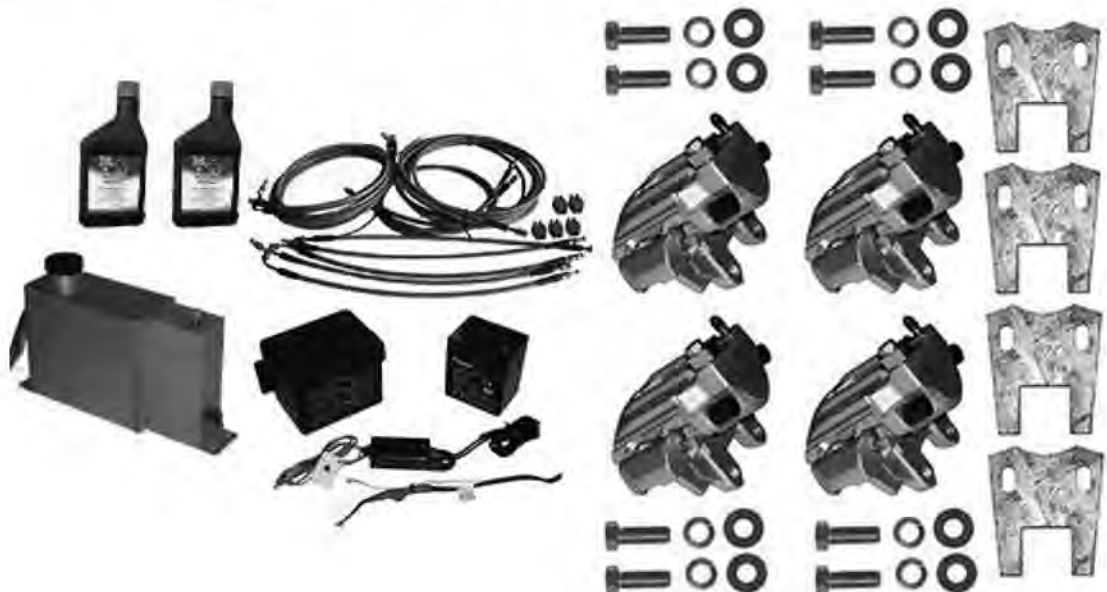

TBKHT2-2

Trailer brake kit electric/hydraulic marinised tandem axle for 12 inch x 5/8 inch to 7/8 inch discs

Kit includes:

- 1 x Hydrastar HBA16 1600psi unit with 2 year warranty
- 1 x Battery breakaway kit 5amp 12v
- 1 x HydraLine kit – for the size, we need your measurement from Hydrastar to the axle.
- 4 x DB35-A UFP aluminium hydraulic brake calipers
- 4 x Axle caliper brackets to suit DB35 UFP calipers. Disc type and axle size required.
- 4 x Bolts to suit UFP DB35 calipers
- 2 x 500ml Enviro Gold Brake Fluid, Dot 4 grade 3.

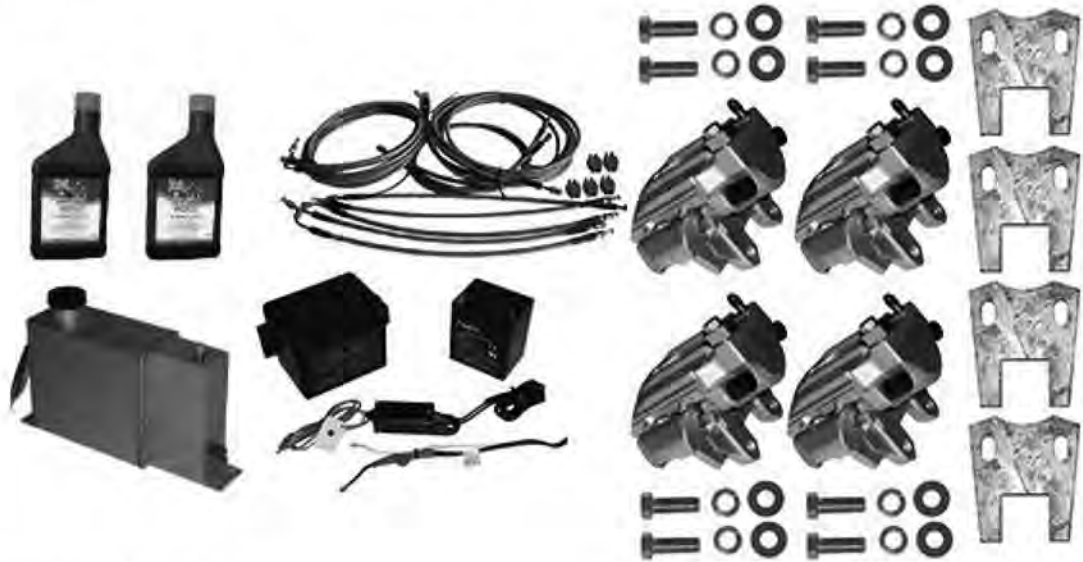

Tri-axle trailer electric/hydraulic brake kit

TBKHT2-3

Trailer brake kit type 2 electric/hydraulic marinised tri-axle for 10 inch or 12 inch x 5/8 inch to 7/8 inch discs

Kit includes:

- 1 x Hydrastar HBA16 1600psi unit with 2 year warranty
- 1 x Battery breakaway kit 5amp 12v
- 1 x HydraLine kit - for the size, we need your measurement from Hydrastar to the axle
- 6 x DB35-A UFP Hydraulic aluminium brake calipers
- 6 x Axle caliper brackets to suit UFP DB35 calipers. Disc type and axle size required.
- 6 x Bolt kit for mounting UFP DB35 calipers
- 2 x 500ml Enviro Gold Brake Fluid Dot 4 grade 3.

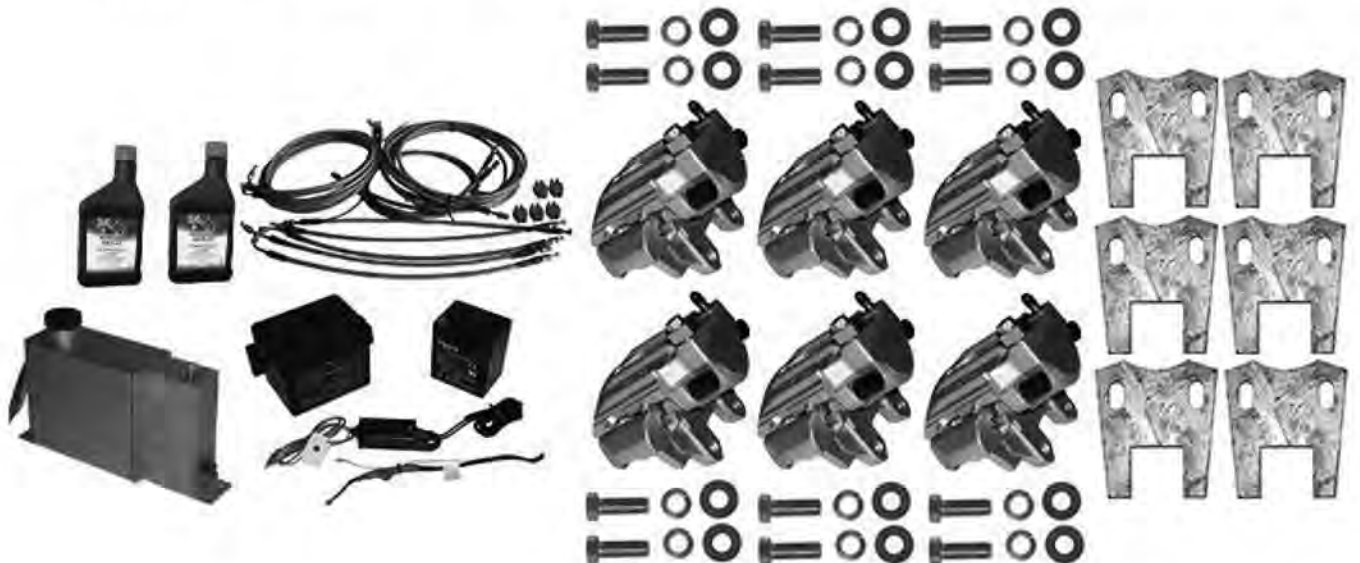

Spring measurements

Eye to Eye (shackle) springs 45mm and 60mm wide

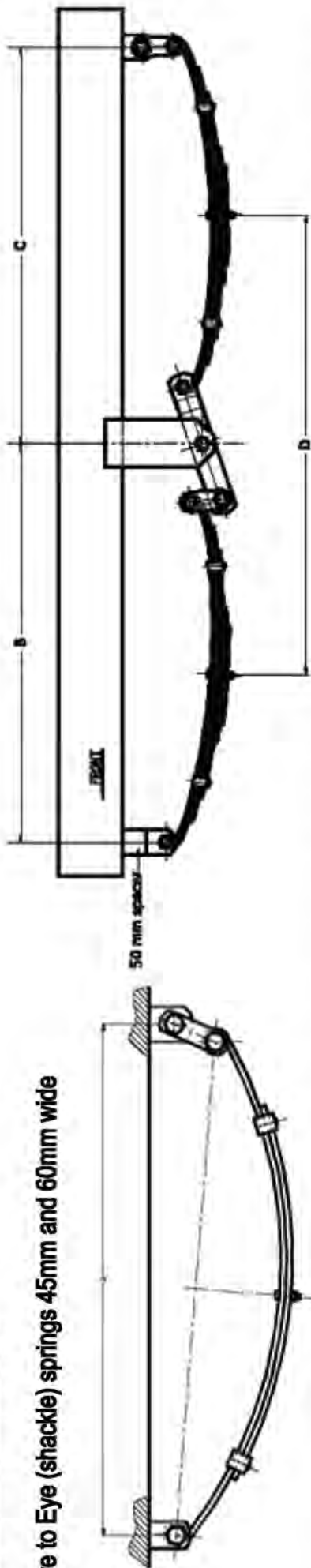

Capacity for two springs	Description	Length of spring from eye to tail	Free camber	Eye to centre bolt	Shackle bolt diameter	Spring bush dimensions	Single axle set up dimension "A" (no load)	B	C	Nominal axle centres minimum "D"	Part number for one spring (no hangers included)	Spring surface finish
700 kg	45mm x 8mm x 2 leaf	711mm	120mm	355mm	9/16"	9/16" x 45mm	735mm	830mm	825mm	960mm	ES2916 ES2D	Black Dac / Galv
850 kg	45mm x 8mm x 3 leaf	711mm	120mm	355mm	9/16"	9/16" x 45mm	735mm	830mm	825mm	960mm	ES3916 ES3D	Black Dac / Galv
1100 kg	45mm x 8mm x 4 leaf	711mm	120mm	355mm	9/16"	9/16" x 45mm	735mm	830mm	825mm	960mm	ES4916 ES4D	Black Dac / Galv
1300 kg	45mm x 8mm x 5 leaf	711mm	120mm	355mm	9/16"	9/16" x 45mm	735mm	830mm	825mm	960mm	ES5916 ES5D	Black Dac / Galv
1500 kg	45mm x 8mm x 6 leaf	711mm	120mm	355mm	9/16"	9/16" x 45mm	735mm	830mm	825mm	960mm	ES6916 ES6D	Black Dac / Galv
1900 kg	45mm x 8mm x 8 leaf	711mm	120mm	355mm	9/16"	9/16" x 45mm	735mm	830mm	825mm	960mm	ES8916 ES8D	Black Dac / Galv
2250 kg	60mm x 7mm x 7 leaf	685mm	117mm	385mm	16mm	16mm x 60mm	710mm	805mm	800mm	1020mm	ES7X60 ES7X60D	Black Dac / Galv
2700 kg	60mm x 7mm x 9 leaf	685mm	117mm	385mm	16mm	16mm x 60mm	710mm	805mm	800mm	1020mm	ES9X60 ES9X60D	Black Dac / Galv

Bolt-on suspension beams

Our innovative designed bolt-on suspension beams take the headache out of DIY trailer builds. The suspension beam already has the correct spring spacings, simply bolt it or fix with U-bolts onto your chassis. All beams are heavy-duty and hot dipped galvanised; made to last the distance. Single suspension beams are available for combining with our range of plastic or metal mudguards on page 82.

Single galvanised suspension beams for plastic guards

- SB13P-L Suspension beam for single slipper left hand. U-bolt to 50mm chassis or fix with bolts to other chassis sizes. Combine with 13 inch plastic mudguards, sold separately.
- SB13P-R Suspension beam for single slipper right hand. U-bolt to 50mm chassis or fix with bolts to other chassis sizes. Combine with 13 inch plastic mudguards, sold separately.
- SB14P-L Suspension beam for single slipper left hand. U-bolt to 50mm chassis or fix with bolts to other chassis sizes. Combine with 14 inch plastic mudguards, sold separately.
- SB14P-R Suspension beam for single slipper right hand. U-bolt to 50mm chassis or fix with bolts to other chassis sizes. Combine with 14 inch plastic mudguards, sold separately.

Plastic guard options in 13 inch and 14 inch, both in white and silver.

See page 82 for full listing. Guards are sold separately.



** Slipper spring range on page 74*

Single galvanised suspension beams for aluminium and metal guards

- SB14A-L Suspension beam for single slipper left hand. U-bolt to 50mm chassis or fix with bolts to other chassis sizes. Combine with your choice of 14 inch aluminium or galvanised steel mudguards. Mudguards sold separately.
- SB14A-R Suspension beam for single slipper right hand. U-bolt to 50mm chassis or fix with bolts to other chassis sizes. Combine with your choice of 14 inch aluminium or galvanised steel mudguards. Mudguards sold separately.

14 inch guard options both in 9inch wide and 10inch wide in a range of materials; aluminium, galvanised steel, plain checkerplate steel, plain steel. See page 82 for full listing. Guards are sold separately.



Tandem galvanised suspension beam assembly

All beams are heavy-duty and hot dipped galvanised; made to last the distance. Bolts into any size I beam, box or C section. Tandem suspension beam assemblies are sold as pairs (left and right side of trailer) and include mudguards, springs and hardware.

Tandem slipper spring suspension beam assembly

SBSSK2000G-2 Heavy-duty galvanised tandem suspension beam slipper spring assembly for a trailer with 2000kg ATM and 13 inch wheels. Sold as pairs and includes aluminium mudguards, 5 leaf slipper springs and hardware.



Tandem rocker spring suspension beam assembly

SBRK2200G-2 Heavy-duty galvanised suspension beam rocker spring assembly for a tandem trailer with 2200kg ATM and 14 inch wheels. Sold as pairs and includes aluminium mudguards, 4 leaf eye eye springs and hardware.

SBRK2600G-2 Heavy-duty galvanised suspension beam rocker spring assembly for a tandem trailer with 2600kg ATM and 14 inch wheels. Sold as pairs and includes aluminium mudguards, 5 leaf eye eye springs and hardware.

SBRK3000G-2 Heavy-duty galvanised suspension beam rocker spring assembly for a tandem trailer with 3000kg ATM and 14 inch wheels. Sold as pairs and includes aluminium mudguards, 6 leaf eye eye springs and hardware.

SBRK3800G-2 Heavy-duty galvanised suspension beam rocker spring assembly for a tandem trailer with 3800kg ATM and 15 inch wheels. Sold as pairs and includes aluminium mudguards, 8 leaf eye eye springs and hardware.



Eye slipper springs

Eye slipper spring 6mm x 45mm wide

SS313	3 leaf 6mm x 45mm wide 600kg rating per pair
SS313D	3 leaf 6mm x 45mm wide 600kg rating per pair dacromet
SS413	4 leaf 6mm x 45mm wide 900kg rating per pair
SS413D	4 leaf 6mm x 45mm wide 900kg rating per pair dacromet
SS513	5 leaf 6mm x 45mm wide 1000kg rating per pair
SS513D	5 leaf 6mm x 45mm wide 1000kg rating per pair dacromet
SS613	6 leaf 6mm x 45mm wide 1200kg rating per pair
SS613D	6 leaf 6mm x 45mm wide 1200kg rating per pair dacromet
SS713	7 leaf 6mm x 45mm wide 1350kg rating per pair
SS713D	7 leaf 6mm x 45mm wide 1350kg rating per pair dacromet
SS913	9 leaf 6mm x 45mm wide 1600kg rating per pair
SS913D	9 leaf 6mm x 45mm wide 1600kg rating per pair dacromet

**Supplied with 1/2 inch bush*



Parabolic spring

PS600G	Parabolic spring 600kg rating per pair galvanised
PS1000G	Parabolic spring 1000kg rating per pair galvanised
PS1400G	Parabolic spring 1400kg rating per pair galvanised



Spring/Suspension hardware is on pages 78-79.

Eye eye springs

Eye eye spring 8mm x 45mm wide x 710mm long

ES3916	3 leaf 8mm x 45mm x 711mm 850kg rating per pair
ES3D	3 leaf 8mm x 45mm x 711mm 850kg rating per pair dacromet
ES4916	4 leaf 8mm x 45mm x 711mm 1100kg rating per pair
ES4D	4 leaf 8mm x 45mm x 711mm 1100kg rating per pair dacromet
ES5916	5 leaf 8mm x 45mm x 711mm 1300kg rating per pair
ES5D	5 leaf 8mm x 45mm x 711mm 1300kg rating per pair dacromet
ES6916	6 leaf 8mm x 45mm x 711mm 1500kg rating per pair
ES6D	6 leaf 8mm x 45mm x 711mm 1500kg rating per pair dacromet
ES8916	8 leaf 8mm x 45mm x 711mm 1900kg rating per pair
ES8D	8 leaf 8mm x 45mm x 711mm 1900kg rating per pair dacromet

*Supplied with 9/16 inch bush



ES6916

Off set eye eye spring 8mm x 45mm wide x 710mm long

ES5D-OS	5 leaf off set 8mm x 45mm x 711mm 1300kg rating per pair dacromet
ES6D-OS	6 leaf off set 8mm x 45mm x 711mm 1500kg rating per pair dacromet
ES8D-OS	8 leaf off set 8mm x 45mm x 711mm 1900kg rating per pair dacromet



ES5D-OS

Eye eye spring 8mm x 45mm wide x 630mm long low profile

ES4-630LPD	4 leaf 8mm x 45mm wide x 630 long low profile (90mm free camber) 1300kg rating per pair dacromet
ES5-630LPD	5 leaf 8mm x 45mm wide x 630 long low profile (90mm free camber) 1500kg rating per pair dacromet

*Supplied with 9/16 inch bush

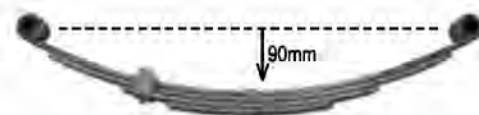

ES4-630LPD

Eye eye spring 8mm x 45mm wide x 835mm long

ES7EL	7 leaf 8mm x 45mm wide x 835mm long 1600kg rating per pair
-------	--



ES7EL

Eye eye spring 7mm x 60mm x 685mm

ES7X60	7 leaf 7mm x 60mm wide x 685mm long 2250kg rating per pair
ES7X60D	7 leaf 7mm x 60mm wide x 685mm long 2250kg rating per pair dacrome
ES9X60	9 leaf 7mm x 60mm wide x 685mm long 2750kg rating per pair
ES9X60D	9 leaf 7mm x 60mm wide x 685mm long 2750kg rating per pair dacrome.



ES7X60

Spring/suspension kits

Single axle kits include two springs plus pins, bushes and all weld-on components. Where listed as galvanised all weld-on components are galvanised and springs are dacromet.

Single axle slipper spring kits

SSK600-1	600kg rated single axle slipper spring kit
SSK600G-1	600kg rated single axle galvanised/dacromet slipper spring kit
SSK900-1	900kg rated single axle slipper spring kit
SSK900G-1	900kg rated single axle galvanised/dacromet slipper spring kit
SSK1000-1	1000kg rated single axle slipper spring kit
SSK1000G-1	1000kg rated single axle galvanised/dacromet slipper spring kit
SSK1200-1	1200kg rated single axle slipper spring kit
SSK1200G-1	1200kg rated single axle galvanised/dacromet slipper spring kit
SSK1350-1	1350kg rated single axle slipper spring kit
SSK1350G-1	1350kg rated single axle galvanised/dacromet slipper spring kit
SSK1600-1	1600kg rated single axle slipper spring kit
SSK1600G-1	1600kg rated single axle galvanised/dacromet slipper spring kit



Single axle slipper spring kit

Single axle shackle spring kits

ESK850-1	850kg rated single axle shackle spring kit
ESK850G-1	850kg rated single axle galvanised/dacromet shackle spring kit
ESK1100-1	1100kg rated single axle shackle spring kit
ESK1100G-1	1100kg rated single axle galvanised/dacromet shackle spring kit
ESK1300-1	1300kg rated single axle shackle spring kit
ESK1300G-1	1300kg rated single axle galvanised/dacromet shackle spring kit
ESK1500-1	1500kg rated single axle shackle spring kit
ESK1500G-1	1500kg rated single axle galvanised/dacromet shackle spring kit
ESK1900-1	1900kg rated single axle shackle spring kit
ESK1900G-1	1900kg rated single axle galvanised/dacromet shackle spring kit
ESK2250-1	2250kg rated single axle shackle spring kit
ESK2250G-1	2250kg rated single axle galvanised/dacromet shackle spring kit



Single axle shackle spring kit

Off-road 60mm rebound spring kits

Sold as per side (two required). Complete with mounting hardware.

ES6OR	6 leaf off-road rebound spring kit 1340kg rating
ES7OR	7 leaf off-road rebound spring kit 1530kg rating
ES8OR	8 leaf off-road rebound spring kit 1720kg rating
ES9OR	9 leaf off-road rebound spring kit 2000kg rating
ES10OR	10 leaf off-road rebound spring kit 2500kg rating
658005	Shock absorber kit contains 2 shocks and hardware



ES7OR

Tandem axle rocker spring kits

RSK2000-2	2000kg tandem axle rocker spring kit
RSK2200G-2	2200kg tandem axle galvanised/dacromet rocker spring kit
RSK2600-2	2600kg tandem axle rocker spring kit
RSK2600G-2	2600kg tandem axle galvanised/dacromet rocker spring kit
RSK3000-2	3000kg tandem axle rocker spring kit
RSK3000G-2	3000kg tandem axle galvanised/dacromet rocker spring kit
RSK3800-2	3800kg tandem axle rocker spring kit
RSK3800G-2	3800kg tandem axle galvanised/dacromet rocker spring kit
RSK4500-2	4500kg tandem axle rocker spring kit
RSK4500G-2	4500kg tandem axle galvanised/dacromet rocker spring kit
RSK5400-2	5400kg tandem axle rocker spring kit
RSK5400G-2	5400kg tandem axle galvanised/dacromet rocker spring kit

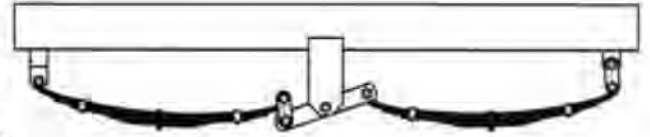

Tri-axle rocker spring kits

RSK3300-3	3300kg tri-axle rocker spring kit
RSK3900-3	3900kg tri-axle rocker spring kit
RSK3900G-3	3900kg tri-axle galvanised/dacromet rocker spring kit
RSK4500-3	4500kg tri-axle rocker spring kit
RSK4500G-3	4500kg tri-axle galvanised/dacromet rocker spring kit
RSK5100G-3	5100kg tri-axle galvanised/dacromet rocker spring kit



Tandem axle rocker roller spring kits

RRSK2000-2	2000kg tandem axle rocker roller spring kit up to 14 inch wheels only
RRSK3000-2	3000kg tandem axle rocker roller spring kit up to 14 inch wheels only
RRSK4000-2	4000kg tandem axle rocker roller spring kit 15 and 16 inch wheels only
RRSK4000D-2	4000kg tandem axle dacromet rocker roller spring kit 15 and 16 inch wheels only
RRSK4500-2	4500kg tandem axle rocker roller spring kit 15 and 16 inch wheels only
RRSK4500D-2	4500kg tandem axle dacromet rocker roller spring kit 15 and 16 inch wheels only



Spring/suspension spares and weld-on

Spring hangers

SH12	45mm x 1/2 inch spring hanger
SH12G	45mm x 1/2 inch galvanised spring hanger
SH916	45mm x 9/16 inch heavy-duty spring hanger
SH916G	45mm x 9/16 inch galvanised spring hanger
SH916EL	45mm x 9/16 inch heavy-duty extended length 50mm drop spring hanger
SH58-50	50mm x 5/8 inch spring hanger
SH58-60	60mm x 5/8 inch heavy-duty spring hanger
SH58-60G	60mm x 5/8 inch heavy-duty galvanised spring hanger
SH58EL-60	60mm x 5/8 inch heavy-duty extended length 50mm drop spring hanger
SH58EL-60G	60mm x 5/8 inch heavy-duty galvanised extended length 50mm drop spring hanger



SH12



SH916



SH916EL

Shackle pins and bolts

SBN12	1/2 inch x 3.5 inch shackle bolt and nut
SP916	9/16 inch x 3.5 inch shackle pin and nut
SP916G	9/16 inch x 3.5 inch greaseable shackle pin and nut
SP58	5/8 inch shackle pin and nut
SP58G	5/8 inch greaseable shackle pin and nut
SP16	16mm x 100mm shackle pin for 60mm springs
SP16G	16mm x 100mm greaseable shackle pin for 60mm wide springs
SP18G	18mm x 100mm greaseable shackle pin for 60mm springs
SP19G	19mm x 85mm greaseable shackle pin for roller rocker centre pivot



SBN12



SP916



SP916G

Shackle plate

SP2.5	2.5 inch 40 x 8mm shackle plate (65mm hole centre)
SP2.5-60	2.5 inch 40 x 8mm shackle plate for 16mm pin
SP2.5-60G	2.5 inch 40 x 8mm shackle plate for 16mm pin galvanised
SP3	3 inch 40 x 8mm shackle plate (75mm hole centre)
SP3G	3 inch 40 x 8mm shackle plate (75mm hole centre) galvanised
SP3-60	3 inch 40 x 8mm shackle plate (75mm hole centre) for 16mm pins
SP3-60G	3 inch 40 x 8mm shackle plate (75mm hole centre) galvanised for 16mm pins
SP3.5	3.5 inch 40 x 8mm shackle plate (90mm hole centre)



SP3

Axle pads

AP8	40x8mm axle pad
AP8G	40x8mm galvanised axle pad



AP8

Shackle bush and rollers

SB12	Nylon shackle bush 1/2 inch x 3.5 inch - 22mm (7/8) outer
SB12-3/4	Nylon spring bush 1/2 inch inner 3/4 inch outer
SB916	Nylon spring shackle bush 9/16 inch x 45mm - 22mm (7/8) outer
SB916-3/4	Nylon spring bush 9/16 inch inner 3/4 inch outer
SB58	Nylon shackle bush 5/8 inch x 45mm - 22mm (7/8) outer
SB58-60	Nylon spring shackle bush 5/8 inch for 60mm wide spring - 22mm (7/8) outer
SR60-S	Steel roller for 60mm roller rocker springs



SB12



SR60-S



DJ45

Dumb jack

DJ45	Dumb jack for 45mm wide springs
DJ60	Dumb jack for 60mm wide springs



DJ60

Spring keeper

SSK45	Slipper spring keeper for 45mm wide springs
SSK45G	Slipper spring keeper for 45mm wide springs galvanised
SSK60	Slipper spring keeper for 60mm wide springs



SSK45

Rocker arms

RAB	Rocker arm banana
RASTD	Rocker arm standard
RASTDG	Rocker arm standard galvanised
RASTD60	Rocker arm standard for 60mm springs use with 16mm rocker pin and nylon bush
RASTD60G	Rocker arm standard for 60mm springs galvanised use with 16mm rocker pin and nylon bush
RASTD60-18	Rocker arm standard for 60mm springs brass bush for use with 18mm rocker pin
RASTD60G-18	Rocker arm standard for 60mm springs galvanised brass bush for use with 18mm rocker pin
RAU60	Rocker arm cast iron for 60mm roller rocker spring



RAB



RASTD

Rocker centre perch

RCPL	165mm rocker centre perch long
RCPLG	165mm galvanised rocker centre perch long
RCPM	140mm rocker centre perch medium
RCPMG	140mm galvanised rocker centre perch medium
RCP60	Rocker centre perch for 60mm springs
RCP60G	Rocker centre perch for 60mm springs galvanised
RCP60-18	Rocker centre perch for 60mm spring use with 18mm rocker pin
RCP60G-18	Rocker centre perch for 60mm springs galvanised use with 18mm rocker pin



RAU60



RCPL



RCPM

U-bolts

1/2 inch round U-bolts

UBR39X3.5G	39mm round x 3.5 inch galvanised U-bolt
UBR39X4.5G	39mm round x 4.5 inch galvanised U-bolt
UBR45X4.5G	45mm round x 4.5 inch galvanised U-bolt
UBR45X5.5G	45mm round x 5.5 inch galvanised U-bolt
UBR45X7G	45mm round x 7 inch galvanised U-bolt
UBR50X6	50mm round x 6 inch U-bolt



1/2 inch square U-bolts

UBS40X4.5G	40mm square x 4.5 inch galvanised U-bolt
UBS40X5.5G	40mm square x 5.5 inch galvanised U-bolt
UBS45X5.5G	45mm square x 5.5 inch galvanised U-bolt
UBS45X6G	45mm square x 6 inch galvanised U-bolt
UBS45X7G	45mm square x 7 inch galvanised U-bolt
UBS50X3G	50mm square x 3 inch galvanised U-bolt
UBS50X4.5G	50mm square x 4.5 inch galvanised U-bolt
UBS50X5.5G	50mm square x 5.5 inch galvanised U-bolt
UBS50X7G	50mm square x 7 inch galvanised U-bolt
UBS50X8G	50mm square x 8 inch galvanised U-bolt



1/2 inch U-bolts

5/8 inch U-bolts

UBS45X6.25X58	45mm square x 6.25 inch U-bolt
UBS50X6.5X58	50mm square x 6.5 inch U-bolt
UBS50X6.5X58G	50mm square x 6.5 inch galvanised U-bolt
UBS50X7X58	50mm square x 7 inch U-bolt
UBR45X5.5X58	45mm round x 5.5 inch U-bolt
UBR60X6.5X58	60mm round x 6.5 inch U-bolt



5/8 inch U-bolts

U-bolts for use with Jockey wheels and legs or other applications over chassis

UBS50X3G 50mm x 3 inch (75mm) square galvanised U-bolt
With nuts and spring washers.



UBS75X3G 75mm x 3 inch (75mm) square galvanised U-bolt
With nuts and spring washers



UBS75X4G 75mm x 4 inch (100mm) square galvanised U-bolt
With nuts and spring washers.



UBS100X3G 100mm x 3 inch (75mm) square galvanised U-bolt
With nuts and spring washers.



UBS100X5G 100mm x 5 inch (125mm) square galvanised U-bolt
With nuts and spring washers.



U-bolt spares

UBNN12G 1/2 inch galvanised nyloc nut

UBFW12G 1/2 inch galvanised flat washer

UBFW58G 5/8 inch galvanised flat washer

Fish plates

FP45 8mm thick fish plate for use with 45mm wide spring

FP45G 8mm thick galvanised fish plate for use with 45mm wide spring

FP45-58G 10mm thick galvanised heavy-duty fish plate for use with 45mm wide spring and 5/8 inch U-bolts

FP60 8mm thick fish plate for use with 60mm wide spring and 1/2 inch U-bolts

FP60G 8mm thick galvanised fish plate for use with 60mm wide spring and 1/2 inch U-bolts

FP60-58 10mm thick heavy-duty fish plate for use with 60mm wide spring and 5/8 inch U-bolts

FP60G-58 10mm thick galvanised heavy-duty fish plate for use with 60mm wide spring and 5/8 inch U-bolts



FP45



FP60-58

Mudguards

Single mudguards - metal 4 fold

MG8X6GAL	8 inch wheel 490mm long x 6 inch wide galvanised
MG13X8	13 inch wheel 670mm long x 8 inch wide black steel
MG13X8GAL	13 inch wheel 670mm long x 8 inch wide galvanised
MG14X9	14 inch wheel 855mm long x 9 inch wide black steel
MG14X9A	14 inch wheel 855mm long x 9 inch wide aluminium
MG14X9GAL	14 inch wheel 855mm long x 9 inch wide galvanised
MG14X10	14 inch wheel 855mm long x 10 inch wide black steel
MG14X10CP	14 inch wheel 855mm long x 10 inch wide checker plate
MG14X10GAL	14 inch wheel 855mm long x 10 inch wide galvanised
MG15X10	15 inch wheel 980mm long x 10 inch wide black steel
MG15X10CP	15 inch wheel 980mm long x 10 inch wide checker plate
MG15X12	15 inch wheel 980mm long x 12 inch wide black steel
MG15X12CP	15 inch wheel 980mm long x 12 inch wide checker plate
MG16X10	16 inch wheel 980mm long x 10 inch wide black steel

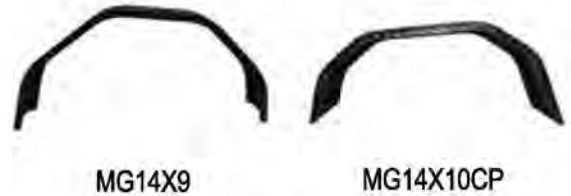

Mudguard length is the space across the base as shown below

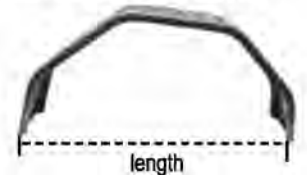

Single mudguards - plastic

MG10P-S	9-10 inch plastic mudguard silver
MG10P-W	9-10 inch plastic mudguard white
MG13P-S	13 inch plastic mudguard silver
MG13P-W	13 inch plastic mudguard white
MG14P-S	14-15 inch plastic mudguard silver
MG14P-W	14-15 inch plastic mudguard white
MGB	Plastic mudguard support bracket fits 10 inch, 13 inch and 14 inch guard



Heavy-duty bolt in suspension beams for single mudguards on page 72

Tandem mudguards - 4 fold

MGTAN1600-A	1600 x 250mm aluminium
MGTAN1650X9	1650mm x 9 inch black steel
MGTAN1650X9GAL	1650mm x 9 inch galvanised
MGTAN1700-A	1700 x 250mm aluminium
MGTAN1740X10	1740mm x 10 inch black steel
MGTAN1740X10CP	1740mm x 10 inch checker plate
MGTAN1740X10GAL	1740mm x 10 inch galvanised
MGTAN1850-A	1850 x 250mm aluminium
MGTAN1860X10	1860mm x 10 inch black steel
MGTAN1860X10CP	1860mm x 10 inch checker plate
MGTAN1860X10GAL	1860mm x 10 inch galvanised
MGTAN1860X12	1860mm x 12 inch black steel



MGTAN1650X9



MGTAN1740X10CP



Tri-axle mudguards

MGTRI2570X9	2570mm x 9 inch black steel
MGTRI2720X9	2720mm x 9 inch black steel

Mudguard accessories

MGSB12	Mudguard support bracket 12 inch galvanised
92180	Weld-on zinc tube including bolt for mudguard support bracket
92182	Weld-on u-frame bracket 50mm x 3mm for mudguard support bracket
SSS304121	1/2 inch bolt 304 stainless for 92182
NS30412	1/2 inch hex nut 304 stainless for 92182
SSS304256M	Stainless set screw 25mm x 6mm for aluminium mudguards
NSS6MN	Stainless steel nut 6mm nyloc for aluminium mudguards
WSS6M	Stainless steel washer 6mm x 12mm for aluminium mudguards
WSS6X19M	Stainless steel washer 6mm x 19mm for aluminium mudguards



92180



92182



MGSB12

Mudflaps

MF165X120S	165mm x 120mm silver plastic mudflap
MF165X120W	165mm x 120mm white plastic mudflap
MF225X180S	225mm x 180mm silver plastic mudflap
MF225X180W	225mm x 180mm white plastic mudflap



MF165X120S

Rims

13 inch steel – Sunraysia style

RIM13X4.5-5HT	13 x 4.5 inch 5 stud HT pattern white
RIM13X4.5-5HTG	13 x 4.5 inch 5 stud HT pattern galvanised
RIM13X4.5-5FD	13 x 4.5 inch 5 stud Ford pattern white
RIM13X4.5-5FDG	13 x 4.5 inch 5 stud Ford pattern galvanised



RIM13X4.5-5FDG

14 inch steel – Sunraysia style

RIM14X6-5FD	14 x 6 inch 5 stud Ford pattern white
RIM14X6-5FDG	14 x 6 inch 5 stud Ford pattern galvanised
RIM14X6-5HT	14 x 6 inch 5 stud HT pattern white
RIM14X6-5HTG	14 x 6 inch 5 stud HT pattern galvanised
RIM14X6-5HQ	14 x 6 inch 5 stud HQ pattern white
RIM14X6-5HQG	14 x 6 inch 5 stud HQ pattern galvanised
RIM14X6-6	14 x 6 inch 6 stud pattern white



RIM14X6-5FD

15 inch steel – Sunraysia style

RIM15X7-5FD	15 x 7 inch 5 stud Ford pattern white
RIM15X7-6	15 x 7 inch 6 stud pattern white
RIM15X7-6G	15 x 7 inch 6 stud pattern galvanised



RIM15X7-6

16 inch steel – Sunraysia style

RIM16X7-6	16 x 7 inch 6 stud pattern white
RIM16X7-5LC	16 x 7 inch LandCruiser 5 stud pattern white

13 inch aluminium

RIM13X5-5KOYAHT	13 x 5 inch HT stud pattern Koya machined aluminium
RIM13X5-5KOYAFD	13 x 5 inch Ford stud pattern Koya machined aluminium

14 inch aluminium

RIM14X6-5KOYAFD	14 x 6 inch Ford stud pattern Koya machined aluminium
RIM14X6-5KOYAHT	14 x 6 inch HT stud pattern Koya machined aluminium

15 inch aluminium

RIM15X6.5-5KOYAFD	15 x 6.5 inch Ford stud pattern Koya machine aluminium
RIM15X6.5-6KOYA	15 x 6.5 inch 6 stud pattern Koya machined aluminium
RIM15X7-6STAMP	15 x 7 inch 6 stud pattern Stampede alloy rim silver



RIM15X6.5-6KOYA

Smaller size aluminium

RIM8HT	8 inch alloy HT stud pattern (suits 140mm lazy hub)
RIM8INT	8 inch alloy Integral
RIM9HT	9 inch alloy HT stud pattern
RIM10HT	10 inch alloy HT stud pattern
RIM10INT	10 inch alloy integral rim

An integral is a one piece rim and hub compatible with LM or slimline bearings.



RIM8INT



RIM8HT

Tyres and tubes

Light truck tyres

T1558013	155/80R13 light trailer tyre 435kg rating per tyre
T155138	155R13 8ply light truck tyre 515kg rating per tyre
T165138	165R13 8ply light truck tyre 670kg rating per tyre
T185148	185R14 8ply light truck tyre 850kg rating per tyre
T195148	195R14 8ply light truck tyre 950kg rating per tyre
T20565R15C	205/65R15 light truck tyre 850kg rating per tyre
T20565R16C	205/65R15 light truck tyre 975kg rating per tyre
T22570R15C	225/70R15 light truck tyre 1120kg rating per tyre
T21560R16C	215/60R16 light truck tyre 1000kg rating per tyre



All terrain tyres

T23575R15	235/75R15 all terrain tyre 920kg rating per tyre
T26575R16	265/75R16 all terrain tyre 1250kg rating per tyre

Off-road mud tyres

T31X10.5R15MT	31 inch x 10.5 inch R15 off-road mud tyre
T24575R16MT	245/75R16 off-road mud tyre
T26575R16MT	265/75 R16 off-road mud tyre



* Rims sold separately.

Tyres and tubes for small aluminium rims

Tube required for 8, 9 or 10 inch tyres.

T4804008	8 inch 6 ply 4.8 x 4.00 x 8 335kg rating per tyre
TUBE8	Tube for 8 inch 4.80/4.00 x 8 tyre
T600X9	9 inch 6 ply 6.00 x 9 inch tyre 510kg rating per tyre
TUBE9	Tube for 9 inch 6.00 x 9 tyre
T500106	10 inch 6 ply 5.00 x 10 inch tyre 440kg rating per tyre
TUBE10	Tube for 5.00 x 10 tyre

Free tyre fitting available when you purchase both rim and tyre from us.

Trailer lights LED

MaxiLite LED tail lights

MX102BL2 MaxiLite 12V LED trailer lamp with licence plate lamp. Slimline 100mm x 100mm x 26mm lamps with inbuilt reflectors. Fully sealed with tinned cable and stainless steel fittings. ADR approved and 3 year warranty.



MX152BL2 MaxiLite 12V LED trailer lamp with licence plate lamp. Slim line 150mm x 80mm x 26mm lamps with inbuilt reflectors. Fully sealed with tinned cable and stainless steel fittings. ADR approved and 3 year warranty.



Narva LED tail lights

93440BL2 12 volt LED slimline trailer lamp pack with licence plate lamp and 0.5m hardwired tinned cable per lamp and stainless steel fittings. Includes: 1 x 12v LED slimline stop/tail, direction indicator lamp with inbuilt retro-reflector and 0.5m hardwired tinned cable; 1 x 12V LED slimline stop/tail, direction indicator and licence plate lamp and inbuilt retro reflector with 0.5m hardwired tinned cable. 5 year LED warranty with Narva. ADR approved.



93640BL2 12 volt LED slimline trailer lamp pack with licence plate lamp and 0.5m hardwired tinned cable per lamp and stainless steel fittings. Includes: 1 x 12v LED slimline stop/tail direction indicator lamp with inbuilt retro reflector and 0.5m hardwired tinned cable; 1 x 12v LED slimline stop/tail, direction indicator and licence plate lamp with inbuilt retro reflector and 0.5m hardwired tinned cable. 5 year LED warranty with Narva. ADR approved.



93642TP 12 Volt LED slimline submersible trailer lamp pack with 9m of hardwired cable per lamp. Includes: 1 x 12V LED slimline stop/tail, direction indicator lamp with inbuilt retro reflector and 9 metres of hardwired cable; 1 x 12V LED slimline stop/tail, direction indicator with licence plate lamp, inbuilt retro reflector and 9 metres of hardwired cable. ADR approved. 5 year LED warranty with Narva.



93812BL2 10-30 volt LED slimline rear stop/tail and direction indicator lamp pack. Includes 0.5m hardwired cable and black bases. Current draw: Tail:0.02A at 10-30V; Stop: 0.08A at 10-30V; Indicator: 0.08A at 10-30V. ADR approved.



Trailer Tail lights LED Kit - White Vision

Provide easy and quick method to wiring trailers. It features a quick fitting plug and go wiring system that eliminates the need for joining wiring, soldering or using scotch locks saving time and consumables. The lights and the wiring are all connected in just seconds using specially developed one-way connectors so each connection is perfect every time. Each trailer kit includes: 2 x LED lamps, All plug and go wiring required; Trailer connectors not included.

TLK55 Trailer light kit LED 10-30 volt with licence plate light 5.5metre lead line 1.4metre rear. Includes CRL14LEDLH and CRL14LEDRH tail lights

TLK71 Trailer light kit LED 10-30 volt with licence plate light 7.1metre lead line 1.7metre rear. Includes CRL14LEDLH and CRL14LEDRH tail lights



Trailer LED light boards

TB153L Trailer LED light board 1.5m long with 8 metres of cable moulded to universal socket. Comes with 3 interchangeable plug system with flat and round plugs.

TB1853L Trailer Led light board 1.85m long with 8 metres of cable moulded to universal socket. Comes with 3 interchangeable plug system with flat and round plugs.



Licence plate lights

MX700BL2 MaxiLite 10-30V multi-voltage LED licence lamp kit. Retail packaged as set of 2. Fully sealed with 150mm hardwired cable and with black mounting base. ADR approved and 3 year warranty.



10-30 volt LED licence plate lamp with 0.5m cable

Dimensions: 41mm x 97mm.

Current draw: 0.03A at 10-30V.

5 year LED warranty with Narva.

ADR approved. ADR48/00 CRN/E mark 41307 – two units required.



90862BL LED licence plate lamp in charcoal/black housing and 0.5m cable. Details as above. Retail packaged

90862 As per 90862BL except non-retail packaged. Economically priced.

90862CBL LED licence plate lamp in chrome/black housing and 0.5m cable. Details as above. Retail packaged.

90862WBL LED licence plate lamp in white housing and 0.5m cable. Details as above. Retail packaged.



Clearance lights / markers

MX580BL MaxiLite 10-30V multi-voltage LED red amber side marker lamp with black mounting base. Fully sealed with 0.4m hardwired cable. ADR approved and 3 year warranty.

10-33v LED markers with black deflector base and 0.5m cable

Dimensions: 35mm x 57mm x 21mm deep.

Current draw: 0.04A at 10-33V.

5 year LED warranty with Narva.

ADR approved. ADR45/00 CRN/E mark 41395.

91402BL LED side marker red/amber side. Details as above. Retail packaged

91402 As 91402BL except non-retail packaged. Economically priced.

91412BL LED front end outline marker lamp (white). Details as above. Retail packaged.

91412 As 91412BL except non-retail packaged. Economically priced.

91422BL LED side marker, external cabin or front end outline marker lamp (amber). Details as above. Retail packaged.

91422 As 91422BL except non-retail packaged. Economically priced.

91432BL LED rear end outline marker lamp (red). Details as above. Retail packaged.

91432 As 91432BL except non-retail packaged. Economically priced.

10-33v LED markers with oval white or chrome deflector base and 0.5m cable

Dimensions: 45mm x 90mm x 26mm deep.

Current draw: 0.04A at 10-33V.

5 year LED warranty with Narva.

ADR approved. ADR45/00 CRN/E mark 41395.

91404CBL LED side marker lamp red/amber with oval chrome base. Details as above. Retail packaged.

91404WBL LED side marker lamp red/amber with oval white base. Details as above. Retail packaged.

91414WBL LED front end outline marker lamp (white) with oval white base. Details as above. Retail packaged.

91424WBL LED side marker, external cabin or front end outline marker lamp (amber) with oval white base. Details as above. Retail packaged.

91434WBL LED rear end outline marker lamp (red) with oval white base. Details as above. Retail packaged.

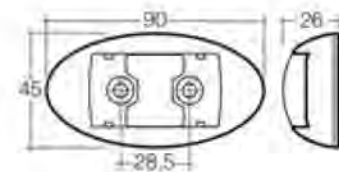
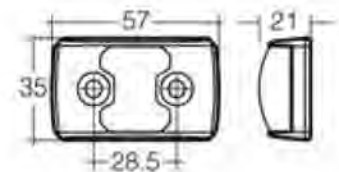

Trailer wire

7 core trailer wire Complies with Australian and New Zealand standard AS/NZS3808.

5872	7 core, 2.5mm 5amp trailer wire. Sold per metre.
5873	7 core, 3mm 10amp trailer wire. Sold per metre.
5874	7 core, 4mm 15amp trailer wire. Sold per metre
5872-30TC	7 core 2.5mm 5amp trailer wire 30m roll
5873-30TC	7 core 3mm 10amp trailer wire 30m roll
5874-30TC	7 core 4mm 15amp trailer wire 30m roll



5872



5874



5873-30TC

Twin core wire Note: the term mm as opposed to mm² is an industry reference and is not the actual cable size.

5823	Twin core 3mm 10amp wire. Sold per metre
5824	Twin core 4mm 15amp wire. Sold per metre
5826	Twin core 6mm 50amp wire. Sold per metre
5828	Twin core 8mm 100amp wire. Sold per metre
5823-30TW	Twin core 3mm 10amp wire 30m roll
5824-30TW	Twin core 4mm 15amp wire 30m roll
5826-30TW	Twin core 6mm 50amp wire 30m roll



5823



5826

Battery boxes

Ideal for securing batteries in areas exposed to the elements e.g. Ute trays. Supplied strap and fittings ensure secure hold when mounted. Includes multiple cable access points and vent holes.

BB285	Standard battery box Suits N50 size batteries Internal size: H:200mm W:190mm L:285mm External size: H:260mm W:275mm L:360mm
BB330	Large battery box Suits N70 size batteries Internal size: H:200mm W:190mm L:330mm External size: H:260mm W:250mm L:410mm
PBT100	Standard plastic battery tray made from plastic and suits common battery sizes up to N50Z. Recessed slots in base so the battery does not make contact with tray fasteners. Size: 185mm x 280mm
PBT200	Large plastic battery tray made from made from plastic and suits common battery sizes up to N70Z. Recessed slots in base so the battery does not make contact with tray fasteners. Size: 185mm x 340mm.



Reflectors

All reflectors are ADR approved.

- 84000BL Clear retro reflector 65mm dia. with fixing bolt.
Pack quantity 2 ADR approved. ADR 47/00 CRN/E mark 15408
- 84001BL Amber retro reflector 65mm dia. with fixing bolt.
Pack quantity 2 ADR approved. ADR 47/00 CRN/E mark 15409
- 84002BL Red retro reflector 65mm dia. with fixing bolt.
Pack quantity 2 ADR approved. ADR 47/00 CRN/E mark 15410
- 84005BL Clear retro reflector 65mm dia. with self-adhesive.
Pack quantity 2 ADR approved. ADR 47/00 CRN/E mark 15411
- 84006BL Amber retro reflector 65mm dia. with self-adhesive.
Pack quantity 2 ADR approved. ADR 47/00 CRN/E mark 15412
- 84007BL Red retro reflector 65mm dia. with self-adhesive.
Pack quantity 2 ADR approved. ADR 47/00 CRN/E mark 15413
- 84010BL Clear retro reflector 60mm dia. with central fixing hole.
Pack quantity 2. ADR approved. ADR 47/00 CRN/E mark 15444
- 84011BL Amber retro reflector 60mm dia. with central fixing hole.
Pack quantity 2. ADR approved. ADR 47/00 CRN/E mark 15445
- 84012BL Red retro reflector 60mm dia. with central fixing hole.
Pack quantity 2. ADR approved. ADR 47/00 CRN/E mark 15446
- 84020BL Clear retro reflector 80mm dia. with central fixing hole.
Pack quantity 2. ADR approved. ADR 47/00 CRN/E mark 15414
- 84021BL Amber retro reflector 80mm dia. with central fixing hole.
Pack quantity 2. ADR approved. ADR 47/00 CRN/E mark 15415
- 84022BL Red retro reflector 80mm dia. with central fixing hole.
Pack quantity 2. ADR approved. ADR 47/00 CRN/E mark 15416
- 84030BL Clear retro reflector 90mm x 40mm with dual fixing holes.
Pack quantity 2. ADR approved. ADR 47/00 CRN/E mark 15657
- 84031BL Amber retro reflector 90mm x 40mm with dual fixing holes.
Pack quantity 2. ADR approved. ADR 47/00 CRN/E mark 15658
- 84032BL Red retro reflector 90mm x 40mm with dual fixing holes.
Pack quantity 2. ADR approved. ADR 47/00 CRN/E mark 15659
- 84035BL Clear retro reflector 70mm x 28mm with self-adhesive.
Pack quantity 2. ADR approved. ADR 47/00 CRN/E mark 15643
- 84036BL Amber retro reflector 70mm x 28mm with self-adhesive.
Pack quantity 2. ADR approved. ADR 47/00 CRN/E mark 15644
- 84037BL Red retro reflector 70mm x 28mm with self-adhesive.
Pack quantity 2. ADR approved. ADR 47/00 CRN/E mark 15645
- 84050BL Clear retro reflector 94mm x 44mm with self-adhesive.
Pack quantity 2. ADR approved. ADR 47/00 CRN/E mark 15435.
- 84051BL Red retro reflector 94mm x 44mm with self-adhesive.
Pack quantity 2. ADR approved. ADR 47/00 CRN/E mark 15443.
- 84052BL Amber retro reflector 105mm x 55mm with self-adhesive.
Pack quantity 2. ADR approved. ADR 47/00 CRN/E mark 15441.



84030BL

84035BL



84031BL

84036BL



84032BL

84037BL

All part numbers ending with "BL" are retail packaged.



84050BL



84051BL



84052BL

- 84060BL Clear retro reflector 105mm x 55mm with self-adhesive. Pack quantity 2. ADR approved. ADR 47/00 CRN/E mark 15442.
- 84061BL Amber retro reflector 105mm x 55mm with self-adhesive. Pack quantity 2. ADR approved. ADR 47/00 CRN/E mark 15441.
- 84062BL Red retro reflector 105mm x 55mm with self-adhesive. Pack quantity 2. ADR approved. ADR 47/00 CRN/E mark 15440.
- 84082BL Red retro reflector 80mm diameter round in white plastic holder with dual fixing holes.
- AR2070 Reflex reflector amber 20mm x 70mm. Non-retail packaged.
- AR4060 Reflex reflector amber 40mm x 60mm. Non-retail packaged.
- AR7545 Reflex reflector amber 75mm x 45mm screw/self-adhesive. Non-retail packaged.
- CR2070 Reflex reflector clear 20mm x 70mm. Non-retail packaged.
- CR4060 Reflex reflector clear 40mm x 60mm. Non-retail packaged.
- CR7545 Reflex reflector clear 75mm x 45mm screw / self-adhesive. Non-retail packaged.
- RR2070 Reflex reflector red 20mm x 70mm. Non-retail packaged.
- RR4060 Reflex reflector red 40mm x 60mm. Non-retail packaged.
- RR7545 Reflex reflector red 75mm x 45mm screw/ self-adhesive. Non-retail packaged.



84060BL



AR2070



AR7545



84082BL

All part numbers ending with "BL" are retail packaged.

Load resistors

- 90034BL Load resistor 12 v 21 w (single). Retail packaged.
- 90034BL2 Load resistor 12 v 21 w (2 pack). Retail packaged.



Cable ties

Black cable ties. UV weather resistant with bent tips for easy entry.

- 56300 Cable tie 2.5mm x 100mm Pack quantity 25
- 56302 Cable tie 3.6mm x 140mm Pack quantity 25
- 56304 Cable tie 4.8mm x 200mm Pack quantity 25
- 56306 Cable tie 4.8mm x 380mm Pack quantity 25
- 56308 Cable tie 4.8mm x 360mm Pack quantity 25
- 56310 Cable tie 7.5mm x 360mm Pack quantity 10



Trailer plugs and sockets

Narva 7 and 12 pin trailer connectors comply with all relevant ADRs. Flat connectors comply with Australian Standard AS4177.5-2004. Large and small round connectors comply with AS2513-1982 while heavy-duty connectors meet the AS4735-2003 standard as required for vehicles and trailers over 3.5 tonnes.

Trailer sockets (car end)

82023BL 6 pin small round plastic socket. Amp rating per pole 15A at 12V. Retail packaged.

82022BL 7 pin small round plastic socket. Amp rating per pole 15A at 12V. ADR compliant ADR42/04. Retail packaged.

82022 As above, non-retail packaged.

82032BL 7 pin small round metal socket. Amp rating per pole 15A at 12V. ADR compliant ADR42/04. Retail packaged.

82032 As above, non-retail packaged.

82033BL 6 pin small round metal socket. Amp rating per pole 15A at 12V. Retail packaged.

82042BL 7 pin flat 'quickfit' plastic socket. Amp rating per pole 15A at 12V. ADR compliant ADR42/04. Retail packaged.

82042 As above, non-retail packaged.

82052BL 7 pin large round plastic socket. Amp rating per pole 30A at 12V. ADR compliant ADR42/04, 64/00. Retail packaged.

82052 As above, non-retail packaged.

82062BL 7 pin large round metal socket. Amp rating per pole 30A at 12V. ADR compliant ADR42/04, 64/00. Retail packaged.

82062 As above, non-retail packaged.

82072BL 12 pin flat plastic socket. 7 pole amp rating per pole 15A at 12V. 5 pole amp rating per pole 35A at 12V. ADR compliant ADR42/04. Retail packaged.

57200BL Heavy-duty 50amp connector housing with copper terminals. (Anderson-type plug) Impact resistant polycarbonate housing and silver plated solid copper terminals. Amp rating: 50A Suits cable size: 8mm². Operating temperature: -20° – 105° C. Retail packaged.

57200 As 5720BL except non-retail packaged.

57200RBL Heavy-duty 50amp red connector keyed differently to prevent accidental connection to grey/black connector. Retail packaged.

57245BL Handle kit suits 50amp connectors

57247BL Rubber dust cover suits 50amp connectors



All part numbers ending with "BL" are retail packaged.

Trailer socket brackets (car end)

- 82305BL Flat bracket for small round plastic sockets.
82305 As above, non-retail packaged.
- 82310BL Angled bracket for small round plastic sockets
82310 As above, non-retail packaged.
- 82315BL Flat bracket for small round metal sockets
82315 As above, non-retail packaged.
- 82320BL Angled bracket for small round metal socket
82320 As above, non-retail packaged.
- 82325BL Angled bracket for large round plastic and metal sockets



Trailer plugs

- 82122BL 6 pin small round plastic trailer plug. Amp rating per pole 15A at 12V
Retail packaged.
- 82121BL 7 pin small round plastic trailer plug. Amp rating per pole 15A at 12V
ADR compliant ADR42/04. Retail packaged.
82121 As above, non-retail packaged.
- 82131BL 7 pin small round metal trailer plug. Amp rating per pole 15A at 12V
ADR compliant ADR42/04. Retail packaged.
82131 As above, non-retail packaged.
- 82132 6 pin small round metal plug. Amp rating per pole 15A at 12V
- 82141BL 7 pin flat 'quickfit' plastic trailer plug. Amp rating per pole 15A at 12V
ADR compliant ADR42/04. Retail packaged.
82141 As above, non-retail packaged.
- 82161BL 7 pin large round metal trailer plug. Amp rating per pole 30A at 12V
ADR compliant ADR42/04, 64/00 Retail packaged.
82161 As above, non-retail packaged.
- 82181BL 7 pin large round plastic trailer plug. Amp rating per pole 30A at 12V
ADR compliant ADR42/04, 64/00
82181 As above, non-retail packaged.
- 82171BL 12 pin flat plastic trailer plug
7 pole amp rating per pole 15A at 12V
5 pole amp rating per pole 35A at 12V
ADR compliant ADR42/04
- 57200BL Heavy-duty 50amp connector housing with copper terminals. (Anderson-type plug)
Impact resistant polycarbonate housing and silver plated solid copper terminals. Amp
rating: 50A. Suits cable size: 8mm². Operating temperature: -20° – 105° C
57200 As per 57200BL except non-retail packaged.
- 57200RBL Heavy-duty 50amp red connector keyed differently to prevent accidental connection to
grey/black connector
- 57245BL Handle kit suits 50amp connectors
- 57247BL Rubber dust cover suits 50amp connectors



Trailer plug adapters

82205BL	7 pin small round socket on car to 6 pin small round plug on trailer
82210BL	6 pin small round socket on car to 7 pin small round plug on trailer
82215BL	7 pin small round socket on car to 7 pin flat plug on trailer
82220BL	6 pin small round socket on car to 7 pin flat plug on trailer
82280BL	6 pin small round socket on car to 7 pin large round plug on trailer
82225BL	7 pin flat socket on car to 7 pin small round plug on trailer
82230BL	7 pin flat socket on car to 6 pin small round plug on trailer
82245BL	7 pin flat socket on car to 7 pin large round plug on trailer
82235BL	7 pin large round socket on car to 7 pin flat plug on trailer
82270BL	7 pin large round socket on car to 6 pin small round plug on trailer
82265BL	7 pin large round socket on car to 7 pin small round plug on trailer
82275BL	7 pin small round socket on car to 7 pin large round plug on trailer



Trailer socket kits (car end)

82045BL	7 pin flat socket kit. Retail packaged. Pre-wired with 1.25m harness and supplied with wire-tap connectors Amp rating per pole 15A at 12V ADR compliant ADR42/04
82025BL	7 pin small round plastic socket kit. Retail packaged. Pre-wired with 1.5m harness and supplied with wire-tap connectors Amp rating per pole 15A at 12V ADR compliant ADR42/04



*All part numbers ending with
'BL' are retail packaged.*

Trailer plug wiring diagram

SMALL ROUND*

*Cable entry view

7 Pin Round Plug & Socket

PIN No.	CIRCUIT	COLOUR
1	Left-hand turn	Yellow
2	Reversing signal	Black
3	Earth return	White
4	Right-hand turn	Green
5	Service brakes	Blue
6	Stop lamps	Red
7	Rear lamps, clearance & side marker lamps	Brown



7 Pin Plug



7 Pin Socket

6 Pin Round Plug & Socket

PIN No.	CIRCUIT	COLOUR
1	Rear lamps, clearance & side marker lamps	Brown
2	Left-hand turn	Yellow
3	Right-hand turn	Green
4	Stop lamps	Red
5	Service brakes	Blue
6	Earth return	White



6 Pin Plug



6 Pin Socket

FLAT*

12 Pin Flat Plug & Socket

PIN No.	CIRCUIT	COLOUR
1	Left-hand turn	Yellow
2	Reversing signal	Black
3	Earth return	White
4	Right-hand turn	Green
5	Service brakes	Blue
6	Stop lamps	Red
7	Rear lamps, clearance & side marker lamps	Brown
8	Battery charger/winch	Orange
9	Auxiliaries/battery lead	Pink
10	Earth return	White
11	Rear fog lamp	Grey
12	Auxiliaries	Violet



12 Pin Plug



12 Pin Socket

7 Pin Flat Plug & Socket

PIN No.	CIRCUIT	COLOUR
1	Left-hand turn	Yellow
2	Reversing signal	Black
3	Earth return	White
4	Right-hand turn	Green
5	Service brakes	Blue
6	Stop lamps	Red
7	Rear lamps, clearance & side marker lamps	Brown



7 Pin Plug



7 Pin Socket

LARGE ROUND*

7 Pin Round Plug & Socket

PIN No.	CIRCUIT	COLOUR
1	Left-hand turn	Yellow
2	Reversing signal	Black
3	Earth return	White
4	Right-hand turn	Green
5	Service brakes	Blue
6	Stop lamps	Red
7	Rear lamps, clearance & side marker lamps	Brown



7 Pin Plug



7 Pin Socket

5 Pin Round Plug & Socket

PIN No.	CIRCUIT	COLOUR
2	Left-hand turn	Yellow
3	Earth return	White
5	Right-hand turn	Green
6	Stop lamps	Red
7	Rear lamps, clearance & side marker lamps	Brown



5 Pin Plug



5 Pin Socket

HEAVY DUTY*

7 Pin H/Duty Round Plug & Socket

PIN No.	CIRCUIT	COLOUR
1 (31)	Earth Return	White
2 (58L)	Left-hand rear, clearance & marker	Black
3 (1)	Left-hand turn	Yellow
4 (54)	Stop lamps	Red
5 (R)	Right-hand turn	Green
6 (58R)	Right-hand rear, clearance & marker	Brown
7 (Centre)	Reversing/Auxiliary	Blue



7 Pin Plug



7 Pin Socket

Manufactured in accordance with the SAEJ560 Standard and in accordance with the Australian Standard AS4735-2003. These connectors are rated at 40A continuous duty. Pin number 1 is self grounded (die cast only) with a peak rating of 70A and accepts wire sizes from 4-8mm².

RV lighting

86830BL Porch light with off/on rocker switch 12v
*12V globe included.

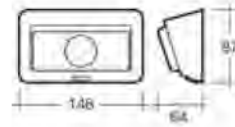

87780BL 9-33 volt LED awning lamp. Modern design with high output LEDs delivering long life and ultra-low current draw. Pre-wired and surface mounted with virtually unbreakable polycarbonate lens.
Current draw: 0.16A at 12V, 0.08A at 24V.
5 year LED warranty from Narva

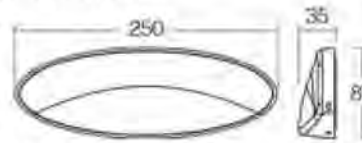

87792 12v LED awning lamp with PIR sensor. Contemporary, sleek design suitable for modern vans, caravans and motor home exteriors. Features a passive infrared (PIR) motion sensor. Delivers a powerful bright white light. Features low current draw, polycarbonate lens and IP66 rating. Current draw: 0.5A at 12V.



87656BL 9-33 volt LED interior swivel lamp with on/off switch. A compact and modern styled interior light utilising six powerful LEDs which produce a smooth spread of crisp white light. Ideal for campers, caravans and mobile homes. Allows easy beam adjustment with 350 degree swivel and 35 degree tilt. Current draw 0.05A at 12V, 0.03A at 24V.

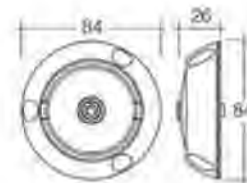

LED tape strip lighting

Flexible LED strip lighting is commonly used in the lighting industry to illuminate cupboards, alcoves and wall recesses where the strip can be hidden yet provide a soft backlit or specific down light illumination, it is perfect for caravans, campers and marine applications. For a softer light output, wall-wash or back-lighting, the 'ambient' types are recommended with a cool white colour temperature. Ideal for boat foot wells, caravan cabinets, under benches etc.

If you want maximum power for full room illumination, 'high output' models are available. Ideal for both interior and exterior fitment around your vehicle, caravan, camper trailer, boat etc. Pre-cut and pre-wired lengths of 300m, 600m and 1.2m are available, packed in individual blister packs. Can be cut to desired lengths with terminals included at 3 LED intervals for soldering. Heat shrink can be used to protect and finish the connection professionally.



87800BL 12 volt LED tape, ambient output, cool white (6000°K) 300mm long.
Flexible LED tape provides a soft, cool white ambient light ideal for background illumination. Self-adhesive with strong 3M™ backing tape.

87801BL 12 volt LED tape, ambient output, cool white (6000°K) 600mm long.
Flexible LED tape provides a soft, cool white ambient light ideal for background illumination. Self-adhesive with strong 3M™ backing tape.

87802BL 12 volt LED tape, ambient output, cool white (6000°K) 1.2m long.
Flexible LED tape provides a soft, cool white ambient light ideal for background illumination. Self-adhesive with strong 3M™ backing tape.

87805BL 12 volt LED tape, high output, cool white (6000°K) 300mm long.
Flexible LED tape provides superior light output. Self-adhesive with strong 3M™ backing tape.

87806BL 12 volt LED tape, high output, cool white (6000°K) 600mm long.
Flexible LED tape provides superior light output. Self-adhesive with strong 3M™ backing tape.



Interior LED strip lamps

Stylish, innovative and versatile strip lamps.

Customise your caravan or RV interior with these sleek and stylish LED strip lamps. Using the supplied interchangeable end caps, the lamps can be surface mounted or corner mounted out of the way for a neat, unobtrusive finish. Multiple lamps can also be interconnected to create continuous lengths of lighting, adding an elegant and professional touch.



- 87524BL** 12/24 volt LED strip lamp 150mm long. Sleek, low profile design with SMD LEDs for a smooth yet powerful light output. Includes changeable ends for surface or corner mounting and can be interconnected to create customised lengths. Fully sealed IP66. Current draw: 0.09A at 12V, 0.05A at 24V. 5 year LED warranty from Narva



- 87526BL** 12/24 volt LED strip lamp 300mm long. Sleek, low profile design with SMD LEDs for a smooth yet powerful light output. Includes changeable ends for surface or corner mounting and can be interconnected to create customised lengths. Fully sealed IP66. Current draw: 0.15A at 12V, 0.07A at 24V. 5 year LED warranty from Narva



- 87550BL** 12v high powered LED strip lamp 83mm long. Ultra-slim, low profile and robust aluminium housing with high powered SMD LED set within a durable and watertight epoxy resin. Impact and vibration resistant, they are ideal for exterior fitment and a broad spread of bright white light and low current draw makes them perfect for fitment to caravans, tool boxes, ute canopies and more. Current draw 0.05A at 12V

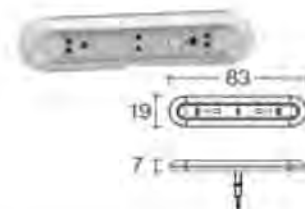

- 87551BL** 12v high powered LED strip lamp 133mm long. Ultra-slim, low profile and robust aluminium housing with high powered SMD LED set within a durable and watertight epoxy resin. Impact and vibration resistant, they are ideal for exterior fitment and a broad spread of bright white light and low current draw makes them perfect for fitment to caravans, tool boxes, ute canopies and more. Current draw 0.10A at 12V



- 87552BL** 12v high powered LED strip lamp 183mm long. Ultra-slim, low profile and robust aluminium housing with high powered SMD LED set within a durable and watertight epoxy resin. Impact and vibration resistant, they are ideal for exterior fitment and a broad spread of bright white light and low current draw makes them perfect for fitment to caravans, tool boxes, ute canopies and more. Current draw 0.15A at 12V



- 87553BL** 12v high powered LED strip lamp 283mm long. Ultra-slim, low profile and robust aluminium housing with high powered SMD LED set within a durable and watertight epoxy resin. Impact and vibration resistant, they are ideal for exterior fitment and a broad spread of bright white light and low current draw makes them perfect for fitment to caravans, tool boxes, ute canopies and more. Current draw 0.25A at 12V



- 87554** 12v high powered LED strip lamp 533mm long. Ultra-slim, low profile and robust aluminium housing with high powered SMD LED set within a durable and watertight epoxy resin. Impact and vibration resistant, they are ideal for exterior fitment and a broad spread of bright white light and low current draw makes them perfect for fitment to caravans, tool boxes, ute canopies and more. Current draw 0.50A at 12V



Saturn LED interior lamps

The range of Saturn LED interior lamps features advanced technology combined with outstanding craftsmanship and design. Manufactured using the latest SMD LEDs, Saturn lamps maintain an incredibly low profile for an elegant and non-intrusive appearance. Offering superior performance, reliability with an ultra-low current draw, the lamps feature a dimming function and an inbuilt touch sensitive on/dim/off switch.

For added convenience, the lamps memory function recalls the last setting used with centrally switched. Available in a selection of shapes and sizes to suit all aspects of interior lighting, the lamps are deceptively robust and feature a virtually unbreakable polycarbonate lens and an IP66 rating which makes them suitable in wet areas. Surface mountable and requiring only a 10mm hole for the cable exit.



87501BL 12v Saturn 75mm round LED interior lamp with touch sensitive on/off switch. Ultra-slim design. Ideal for surface mount down-lighting, requiring only a 10mm hole for cable exit. Current draw: 0.03A at 12V

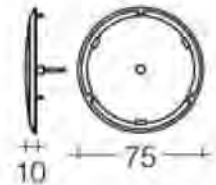

87503BL 12 volt Saturn 130mm LED interior lamp with touch sensitive on/off switch. Ultra-slim surface mount design maximises headroom in enclosed cabin areas. Current draw: 0.20A at 12V.

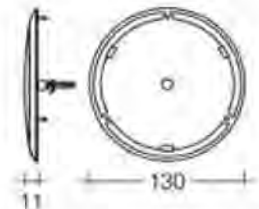

87505BL 12v Saturn 180mm round LED interior lamp with touch sensitive on/off switch. Smooth yet powerful LEDs with an inbuilt Off/On switch. The lamp is surface mountable and ideal for illuminating central and living areas. Current draw: 0.35A at 12V

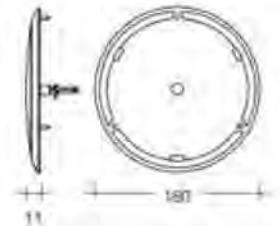

87509BL 12v Saturn 185mm x 150mm rectangular LED interior lamp with touch sensitive on/off switch. Smooth yet powerful LEDs with an inbuilt off/on switch. A large elegant lamp, surface mountable and ideal for illuminating central and living areas. Current draw: 0.40A at 12V



87513BL 12v Saturn 220mm x 100mm rectangular LED interior lamp with touch sensitive on/off switch. Smooth yet powerful LEDs with an inbuilt on/off switch. Ultra-slim surface mount design maximises headroom for enclosed cabin areas. Current draw: 0.30A at 12V

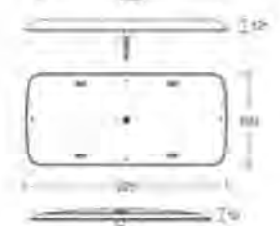

87517BL 12v Saturn 200mm x 120mm oval LED interior lamp with touch sensitive on/off switch. Smooth yet powerful LED with an inbuilt on/off switch. Elegant oval design compliments modern interiors and is surface mountable requiring only a 10mm hole for cable exit. Current draw: 0.30A at 12V

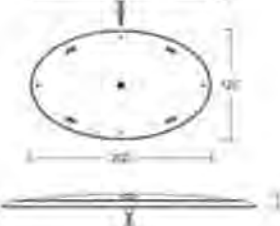

87521BL 12v Saturn 280mm x 110mm oval LED interior lamp with touch sensitive on/off switch. Smooth yet powerful LEDs with an inbuilt off/on switch. A large elegant oval lamp, surface mountable and ideal for illuminating central and living areas. Current draw: 0.40A at 12V.

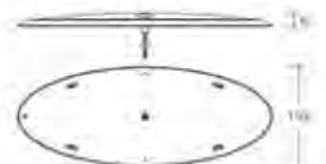

RV plugs, adapters and accessories

- 57200BL Heavy-duty 50amp connector housing with copper terminals. (Anderson-type plug)
Impact resistant polycarbonate housing and silver plated solid copper terminals.
Amp rating: 50A Suits cable size: 8mm². Operating temperature: -20° – 105° C
- 57200 As 57200BL, except non-retail packaged.
- 57200RBL Heavy-duty 50amp red connector keyed differently to prevent accidental connection to grey/black connector. Retail packaged.
- 57245BL Handle kit suits 50amp connectors
- 57247BL Rubber dust cover suits 50amp connectors
- 81135BL Easy to read LED volt meter displays accurate battery voltage level for quick reference.
Can be installed with or without the mounting panel. Volt meter range: 6-33V DC.
Mounting opening: 29mm dia.
- 81136BL Easy to read LED volt meter displays accurate battery voltage level for quick reference.
Can be installed with or without the mounting panel. Volt meter range: .05-20 AMP.
- 81145BL Easy to read LED volt meter displays accurate battery voltage level for quick reference.
Features dustproof accessory socket cover and heavy-duty construction
Amp rating 20A at 12V, 10A at 24V
Volt meter range: 6–33V DC
- 81148BL Easy to read LED volt and Amp meters display accurate battery voltage level and
amperage draw for quick reference
Volt meter range: 6–33V DC
Amp meter range: 0.5–20Amp
- 81010BL Cigarette lighter plug with off/on rocker switch and LED indicator.
Features fuse protection, 300mm straight lead and an adapter for European vehicles.
Amperage rating 8amp at 12v.
- 81012BL Cigarette lighter plug with on/off rocker switch, LED indicator and spiral lead.
Features fuse protection, spiral lead that extends to 3 metres and an adapter for
European vehicles. Amperage rating 8A at 12V.
- 81016BL Cigarette lighter gun style plug with LED indicator.
Features unique pistol grip design, fuse protection, 300mm straight lead and an adapter
for European vehicles. Amperage rating 10A at 12V.
- 81018BL Cigarette lighter gun style plug with LED indicator and spiral lead
Features unique pistol grip design, fuse protection, spiral lead that extends to 3.5
metres and an adapter for European vehicles. Amperage rating 10A at 12V.
- 81023BL Heavy-duty in-line accessory socket
Features moulded dustproof cover and 1m straight lead. Amperage rating 20A at 12V,
10A at 24V.



- 81024BL Cigarette lighter plug. High current carrying capacity for use with a large variety of 12V and 24V DC applications. Includes an adapter for European vehicles. 1m straight lead. Amperage rating 20A at 12V, 10A at 24V.
- 81033BL Heavy-duty adapter. Cigarette lighter plug to twin accessory sockets. Ideal for powering multiple appliances with cigarette lighter plugs from vehicles accessory socket. Features dustproof covers and 150mm straight lead. Amperage rating 20A at 12V, 10A at 24V.
- 81034BL Battery clips with extended lead and accessory socket. Features battery clips with 450mm of straight lead for direct connection to battery. Amperage rating 10A at 12V, 5A at 24V.
- 81039BL Twin USB power adapter. Ideal for running multiple electronic items, this compact USB adapter offers a flush factory finish when fitted. Features an illuminated LED fascia to indicate the sockets are active and provides easy night-time use. Suitable for use with 12V or 24V vehicles and power supplies. Output 5V, 2.5A.
- 81040BL Cigarette lighter plug with adjustable twin accessory sockets. Features 4 adjustable positions through to 90°, fuse protection, illuminated ring (green) and an adapter for European vehicles. Amperage rating 10A at 12V.
- 81044BL Cigarette lighter plug with adjustable twin accessory sockets and lighter fixture. Features 4 adjustable positions through to 90°, fuse protection, illuminated ring (green) and an adapter for European vehicles. Amperage rating 10A at 12V.
- 81042BL Heavy-duty adapter. Cigarette lighter plug to Merit and accessory sockets. Ideal for powering appliances with cigarette lighter or Merit plugs from a vehicles accessory socket. Features dustproof cover and 150mm straight lead. Amperage rating 16A at 12V, 8A at 24V.
- 81043BL Heavy-duty adapter. Merit plug to Merit and accessory sockets. Ideal for powering appliances with cigarette lighter or Merit plugs from a Merit socket. Features dustproof cover and 150mm straight lead. Amperage rating 16A at 12V, 8A at 24V.
- 81047BL 5m heavy-duty accessory extension lead. Features 5m heavy-duty cable for maximum power efficiency. Amperage rating 20A at 12V, 10A at 24V.
- 81048BL Cigarette lighter plug with extended lead and triple accessory sockets. Features fuse protection, 1 metre lead and an adapter for European vehicles. Amperage rating 8A at 12V, 4A at 24V.



All part numbers ending with "BL" are retail packaged.



81054BL

Twin USB power adapter kit

An all-in-one kit ideal for powering modern electronic devices including tablets, PDAs, smart phones, GPS etc. Features a 75cm retractable adapter lead for tangle free storage and 3 interchangeable tips including Micro USB, Apple® and Nokia® 2mm connectors. Suitable for use with 12V or 24V vehicles and power supplies. Output 5V, 2.5A.



81150BL

Heavy-duty surface mount Merit socket

Features dustproof cover and stylish surface mount plastic housing. Moulded housing allows fitment to interior or exterior panels for easy installation. Amperage rating 16A at 12V, 8A at 24V.



81154BL

Moulded housing allows fitment to interior or exterior panels for easy installation. Amperage rating 16A at 12V, 8A at 24V.

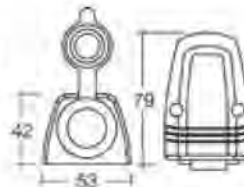

81025BL

Heavy-duty surface mount accessory socket

Features dustproof cover and stylish surface mount plastic housing. Moulded housing allows fitment to interior or exterior panels for easy installation. Amperage rating 20A at 12V, 10A at 24V.



81025WBL

Heavy-duty surface mount accessory socket – white for RV and marine applications. Features dustproof cover and stylish surface mount plastic housing. Moulded housing allows fitment to interior or exterior panels for easy installation. Amperage rating 20A at 12V, 10A at 24V.



81026BL

Heavy-duty accessory socket. Features dustproof cover and heavy-duty construction. The fitting mechanism allows installation into interior or exterior panels including steel and aluminium. Can be installed with or without the mounting panel. Amperage rating 20A at 12V, 10A at 24V. Mounting opening 29mm dia.

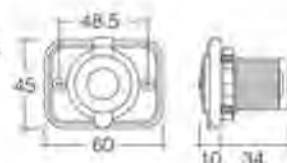

81028BL

Accessory socket with optional mounting panel. Features dustproof cover and 300mm lead. Can be mounted with or without the mounting panel. Amperage rating 10A at 12V, 5A at 24V. Mounting opening 28mm dia.



81130BL

Heavy-duty Merit socket. Features dustproof cover and heavy-duty construction. The fitting mechanism allows installation into interior or exterior panels including steel and aluminium. Can be installed with or without the mounting panel. Amperage rating 16A at 12V, 8A at 24V. Mounting opening 29mm dia.



81132BL

Heavy-duty Engel type socket. Features dustproof cover and heavy-duty construction. The fitting mechanism allows installation into interior or exterior panels including steel and aluminium. Can be installed with or without the mounting panel. Amperage rating 15A at 12V, 7.5A at 24V. Mounting opening 29mm dia.



81134BL

Heavy-duty dual USB socket. Features dustproof cover and heavy-duty construction. The fitting mechanism allows installation into interior or exterior panels including steel or aluminium. Can be installed with or without the mounting panel. Output 5V, 2.5A. Mounting opening 29mm dia.



81140BL Heavy-duty twin accessory / Merit sockets
Features dustproof covers and heavy-duty construction. The fitting mechanism allows installation into interior or exterior panels including steel and aluminium. Amperage rating: Accessory socket 20A at 12V, 10A at 24V; Merit socket 16A at 12V, 8A at 24V. Mounting opening 29mm dia. per socket.



81027BL Heavy-duty twin accessory sockets. Features dustproof covers and heavy-duty construction. The fitting mechanism allows installation into interior or exterior panels including steel and aluminium. Amperage rating 20A at 12V, 10A at 24V per socket. Mounting opening 29mm dia. per socket.

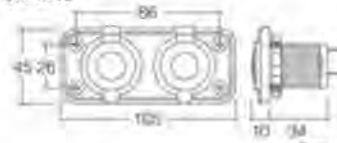

81142BL Heavy-duty twin Merit/Engel type sockets
Features dustproof covers and heavy-duty construction. The fitting mechanism allows installation into interior or exterior panels including steel and aluminium. Amperage rating: Merit socket 16A at 12V, 8A at 24V; Engel type socket 15A at 12V, 7.5A at 24V. Mounting opening 29mm dia. per socket.



81144BL Heavy-duty twin accessory / dual USB sockets. Features dustproof covers and heavy-duty construction. The fitting mechanism allows installation into interior or exterior panels including steel and aluminium. Amperage rating: Accessory socket 20A at 12V, 10A at 24V; USB output 5V, 2.5A. Mounting opening 29mm dia. per socket.



81160BL Heavy-duty twin surface mount accessory sockets
Features dustproof covers and stylish surface mount plastic housing. Moulded housing allows fitment to interior or exterior panels for easy installation. Amperage rating 20A at 12V, 10A at 24V per socket.

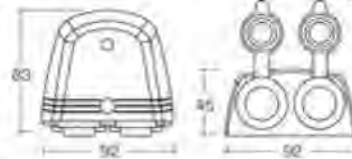

81160WBL Heavy-duty twin surface mount accessory sockets in white for RV and Marine applications.
Features dustproof covers and stylish surface mount plastic housing. Moulded housing allows fitment to interior or exterior panels for easy installation. Amperage rating 20A at 12V, 10A at 24V per socket.



81164BL Heavy-duty twin surface mount accessory / Merit sockets
Features dustproof covers and stylish surface mount plastic housing. Moulded housing allows fitment to interior and exterior panels for easy installation. Amperage rating: Accessory socket 20A at 12V, 10A at 24V; Merit socket 16A at 12V, 8A at 24V.



81168BL Heavy-duty twin surface mount accessory/dual USB sockets
Features dustproof covers and stylish surface mount plastic housing. Moulded housing allows fitment to interior and exterior panels for easy installation. Amperage rating: Accessory socket 20A at 12V, 10A at 24V; USB output 5V, 2.5A.

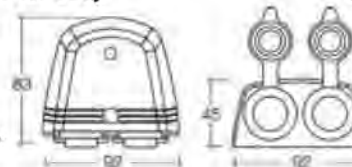

81168WBL Heavy-duty twin surface mount accessory/dual USB sockets
Features dustproof covers and stylish surface mount plastic housing
Amp rating: Accessory Socket 20A at 12V, 10A at 24V
USB Output 5V, 2.5A



82100BL Heavy-duty in-line Merit socket
Features dustproof cover and heavy-duty construction. Solder/push on terminals. Amperage rating 16A at 12V, 8A at 24V.



82103BL Thermoplastic Merit socket
Plastic body noncorrodible, ideal for marine applications.
Fitted with push on terminals.
Amperage rating 16A at 12v, 8A at 24V.



82104BL Aluminium Merit socket
Fitted with screw terminal and thermoplastic lid.
Amperage rating 20A at 12V, 10A at 24V.



82105BL Aluminium Merit socket
Fitted with thermoplastic lid, separate power and earth terminals.
Amperage rating 20A at 12V, 10A at 24V.



82106BL Thermoplastic Merit plug
Amperage rating 20A at 12V, 10A at 24V.



82107BL Features right angle housing for further fitment options.
Ideal for tight spaces
Amperage rating 20A at 12V, 10A at 24V



82109BL Thermoplastic Engel type plug
With screw fitting for secure connection.
Amperage rating 15A at 12V, 7.5A at 24V.



82110BL Combination cigarette lighter plug/Merit plug. Fits all standard accessory sockets, and Merit sockets when the red tip is removed. Features LED power on indicator and fuse protection.
Amperage rating 15A at 12V, 8A at 24V.



81060BL 12v vehicle fan with high/low setting, fixed mounting bracket and hard wired cable. Features a 200mm flexible arm, impact resistant protective grille and super quiet operation. Ideal for caravans, motor-homes and truck cabins. Current draw: 0.27A high, 0.19A Low.



81064BL 12v vehicle fan with high/low setting and cigarette lighter plug.
Features a 200mm flexible arm, impact resistant protective grille and super quiet operation. Ideal for caravans, motor-homes and truck cabins.
Current draw: 0.27A high, 0.19A low



Marine trailer hardware

Wood yoke stems

91801	6 inch wood yoke straight 20mm stem galvanised
91802	8 inch wood yoke straight 20mm stem galvanised
91811	8 inch wood yoke angled 20mm stem galvanised
91803	12 inch wood yoke straight 20mm stem galvanised
91812	12 inch wood yoke angled 20mm stem galvanised
92111	8 inch square wood yoke 40mm stem galvanised
92112	8 inch square wood yoke 40mm stem galvanised drilled yoke
92113	8 inch square wood yoke slimline suit fixed wobble arm



91811



92112



91803



92113

Flat brackets

92001	3 inch flat bracket galvanised
92002	4 inch flat bracket galvanised
92003	4.5 inch flat bracket galvanised
92004	6 inch flat bracket galvanised
92005	8 inch flat bracket galvanised
92006	8 inch flat bracket with 20mm hole galvanised
92008	12 inch flat bracket 26mm hole heavy-duty 50 x 6mm galvanised



92003



92051

Single stem brackets

92050	4.5 inch stem bracket - 6 inch x 20mm square
92051	6 inch stem bracket - 6 inch x 20mm square
92052	8 inch stem bracket - 6 inch x 20mm square

Twin stem brackets

92053	8 inch twin stem flat bracket galvanised - 8 inch x 18mm square stem. Hole size to fit 16mm spindle. Distance between stems 115mm.
92055	8 inch twin stem flat bracket - 8 inch x 18mm square stem. Hole size to fit 18mm spindle. Distance between stems 115mm.
92056	6 inch twin stem flat bracket - 6 inch x 18mm square stem. Hole size to fit 16mm spindle. Distance between stems 90mm



92056

Tandem roller brackets

92060	4.5 inch tandem roller bracket galvanised
92061	6 inch tandem roller bracket galvanised
92062	8 inch tandem roller bracket galvanised
GBKT150DR	6 inch tandem roller bracket assembly with pins galvanised heavy-duty
GBKT200DR	8 inch tandem roller bracket assembly with pins galvanised heavy-duty
GBKT300DR	12 inch tandem roller bracket assembly with pins galvanised heavy-duty



92061



GBKT200DR

Wobble brackets

92080	Double wobble bracket - 18mm big clamp
92081	Double wobble bracket - 22mm big clamp
92085	Single wobble bracket - 18mm
92090	Long bend wobble bracket - left hand
92091	Long bend wobble bracket - right hand
92092	Short bend wobble bracket - left hand
92093	Short bend wobble bracket - right hand
92079	Quad wobble roller bracket galvanised
GBKTDWRB	Double wobble roller bracket assembly with washers galvanised
GBKTQWRB	Quad wobble roller bracket assembly galvanised
92114	Dual fixed wobble arm
92115	Adjustable wobble arm
92125	Double wobble roller mounting arm 600 x 50 x 50mm suit 72mm wide pivot block
92125-30	Double wobble roller mounting arm 600 x 50 x 50mm
92127	Triple wobble roller mounting arm 600 x 75 x 50mm suit 72mm wide pivot block
92129	Rubber block for wobble roller arm
92103	Multi-roller pivot block



GBKTQWRB



GBKTDWRB



92093



92085



92090



92080



92115



92114



92103



92079

Tube side adjuster

92118	40mm tube slide adjuster 2 x 2 inch
92119	40mm tube slide adjuster 3 x 2 inch
92120	40mm tube slide adjuster 4 x 2 inch
92121	40mm tube slide adjuster 3 x 3 inch
92150	50mm tube slide adjuster 2 x 1 inch
92151	50mm tube slide adjuster 2 x 2 inch
92152	75mm tube slide adjuster 3 x 2 inch
92152-3	75mm tube slide adjuster 3 x 3 inch
92153	100mm tube slide adjuster 4 x 2 inch
92161	50mm tube slide adjuster 2 inch x 1 inch x 6 inch
92162	50mm tube slide adjuster 2 inch x 2 inch x 8 inch
92163	75mm tube slide adjuster 3 inch x 2 inch x 8 inch
92180	3 inch weld-on tube side adjuster with bolt
92182	Weld-on U-frame bracket 50mm x 3mm for use with mudguard support bracket
NS30412	1/2 inch hex nut 304 stainless for use with 92182
SSS304121	1/2 inch bolt 304 stainless for use with 92182



92125



92127



92125-30



92161



92163



92152



92180



92182



92120

Eye posts

92171	6 inch eye post suit 16mm pin galvanised
92172	8 inch eye post suit 16mm pin galvanised
92173	12 inch eye post suit 16mm pin galvanised
92174	12 inch eye post suit 20mm pin galvanised



Motor support

MSB1	Motor support bracket
MSB2	Motor support bracket long inner
MSBR	Replacement rubber for motor support bracket
MSKWB1	Motor support key way bolt-on
MSKWC1	Motor support key way clamp-on 2 x 1 inch
MSKWC2	Motor support key way clamp-on 2 x 2 inch
MSKWW1	Motor support key way weld-on



Winch posts

WP1	2 x 2 inch galvanised light duty winch post to suit 50-75mm draw bar
WP2	3 x 2 inch galvanised medium duty winch post to suit 75-100mm draw bar
WP3	3 x 3 inch galvanised heavy-duty winch post to suit 75-100mm draw bar



Tinny movers

JWTW	Clamp on tinny mover wheel
------	----------------------------



Rollers

Winch post rollers

FEC3NB	3 inch front end cap blue nylon 13mm centre hole
FEC3P	3 inch front end cap red poly
FECPSR	2.5 inch front end cap red poly soft 17mm centre hole
FEC25R	2.5 inch front end cap black rubber
FEC25TR	2.5 inch front end cap taper black rubber
BR3NB	3 inch bow roller blue nylon 17mm centre hole
BR3R	3 inch bow roller rubber 17mm centre hole
BR2P	2 inch bow roller poly red 12mm centre hole
BR3P	3 inch bow roller red poly soft 17mm centre hole
WPVB2PR	2 inch winch post V block poly red.
WPVB3PR	3 inch winch post V block poly red.
WPVB4PR	4 inch winch post V block poly red.
WPVB3R	3 inch winch post V block black rubber.
WPVB4R	4 inch winch post V block black rubber. 100mm x 55mm base 85mm UV stable.
WPVB44R	4 inch x 4 inch winch post V block black rubber.



FEC3NB



BR3NB



FEC3P



BR3R



FEC25R



BR2P



FEC25TR



WPVB4R

Keel rollers – Nylon

KR4NB	4 inch keel roller blue nylon 17mm centre hole. UV stable polypropylene. Non-marking.
KR4.5NB	4.5 inch keel roller blue nylon 17mm centre hole. UV stable polypropylene. Non-marking.
KR6NB	6 inch keel roller blue nylon 17mm centre hole UV stable polypropylene. Non-marking.
KR6SCNB	6 inch keel roller self-centring blue nylon 17mm centre hole UV stable polypropylene. Non-marking.
KR8CNB	6 inch keel roller concave blue nylon 17mm centre hole. UV stable polypropylene. Non-marking.
KR8CNB-20	8 inch keel roller concave blue nylon 20mm centre hole UV stable polypropylene. Non-marking.
KR8NB	8 inch keel roller blue nylon. 17mm centre hole for use with 16mm spindle. UV stable polypropylene. Non-marking.
KR8NB-20	8 inch keel roller blue nylon 20mm centre hole. UV stable polypropylene. Non-marking.
KR8SCNB	8 inch keel roller self-centring blue nylon. 17mm centre hole for use with 16mm spindle. UV stable polypropylene. Non-marking.
KR8SRNB	8 inch Sydney keel roller blue nylon. 17mm centre hole for use with 16mm spindle. UV stable polypropylene. Non-marking.
KR8SRNB-22	8 inch Sydney keel roller blue nylon 22mm centre hole. UV stable polypropylene. Non-marking.



KR4NB



KR6NB



KR8CNB-20



KR8SCNB

Keel rollers – Poly

KR4PSR	4 inch keel roller red poly soft. 17mm centre hole for use with 16mm spindle. UV stable polyurethane. Non-marking.
KR4.5NBAC	4.5 inch keel roller tough poly red alloy centre. 17mm centre hole for use with 16mm spindle. UV stable polyurethane. Non-marking
KR4.5PSR	4.5 inch keel roller red poly soft 17mm centre hole for use with 16mm spindle. UV stable polyurethane. Non-marking
KR6PSR	6 inch keel roller red poly soft 17mm centre hole for use with 16mm spindle. UV stable polyurethane. Non-marking
KR6SCPSR	6 inch keel roller self-centring red poly soft 17mm centre hole for use with 16mm spindle. UV stable polyurethane. Non-marking
KR8PSR	8 inch keel roller red poly soft 17mm centre hole for use with 16mm spindle. UV stable polyurethane. Non-marking
KR8PSR-21	8 inch keel roller red poly soft 21mm centre hole. UV stable polyurethane. Non-marking.
KR8SCPSR	8 inch keel roller self-centring red poly soft 17mm centre hole for use with 16mm spindle. UV stable polyurethane. Non-marking
KR8CPSR	8 inch keel roller concave red poly soft. 17mm centre hole. UV stable polyurethane. Non-marking.
KR8CPSR-22	8 inch keel roller concave red poly soft. 22mm centre hole. UV stable polyurethane. Non-marking.
KR12CPSR	12 inch keel roller concave red poly soft. 25mm centre hole. UV stable polyurethane. Non-marking.
BR6P	6 inch bilge roller red poly soft. UV stable polyurethane. Non-marking.
BR8P-22	8 inch flat bilge roller red poly soft. UV stable polyurethane. Non-marking
BR12P	12 inch flat bilge roller red poly soft. UV stable polyurethane. Non-marking



Keel rollers - rubber

KR4R	4 inch keel roller black rubber 17mm centre hole for use with 16mm spindle. UV stable.
KR4.5R	4.5 inch keel roller black rubber 17mm centre hole. UV stable.
KR6R	6 inch keel roller black rubber 17mm centre hole. UV stable.
KR8R	8 inch keel roller black rubber 17mm centre hole. UV stable.
KR8SCR	8 inch keel roller self-centring black rubber 17mm centre hole. UV stable.
BR8R	Bilge roller 8 inch rubber
BR12R	Bilge roller 12 inch rubber
DBGR300X24	12 inch dog bone roller grey non-marking rubber



Wobble rollers

WR3RB20	3 inch wobble roller ribbed blue 20mm centre hole
WR3RB26	3 inch wobble roller ribbed blue 26mm centre hole
WR3RG20	3 inch wobble roller ribbed grey 20mm centre hole
WR3RG26	3 inch wobble roller ribbed grey 26mm centre hole
WR3RR20	3 inch wobble roller ribbed red 20mm centre hole
WR3RR26	3 inch wobble roller ribbed red 26mm centre hole
WR4SB20	4 inch wobble roller smooth blue 20mm centre hole
WR4SB26	4 inch wobble roller smooth blue 26mm centre hole
WR4SBLK20	4 inch wobble roller smooth black 20mm centre hole
WR4SBLK26	4 inch wobble roller smooth black 26mm centre hole
WR4SR20	4 inch wobble roller smooth red 20mm centre hole
WR4SR26	4 inch wobble roller smooth red 26mm centre hole



WR4SB20



WR3RR26



WR3RG26

Roller spindles

RS135	135mm x 16mm roller spindle zinc plated
RS145	145mm x 16mm roller spindle zinc plated for 4.5 inch flat bracket.
RS203	203mm x 16mm roller spindle zinc plated for 6 inch flat bracket
RS235	235mm x 16mm roller spindle zinc plated
RS240	240mm x 18mm roller spindle zinc plated
RS279	279mm x 16mm roller spindle zinc plated
RS285	285mm x 18mm roller spindle zinc plated
RS340	340mm x 18mm roller spindle zinc plated
RS358	358mm x 23mm roller spindle zinc plated
RSW16	Roller spindle washer for 16mm spindle galvanised
RSW18	Roller spindle washer for 18mm spindle galvanised
RSW24	Roller spindle washer for 24mm spindle galvanised
SPSS3.2X40	Split pin 3.2 x 40mm stainless steel
SPSS3.2X50	Split pin 3.2 x 50mm stainless steel



RSW24



Skid strip, block and bunks

BTSS15	1.5m long blue nylon skid strip
BTSS30	3.0m long blue nylon skid strip
BTSB30	30cm long blue nylon skid block
BTSB15	1.5m long blue nylon skid block



BTSB30



BTSS15



BTSS30

Winches

Marine winches

- SMW003C** Tinny winch with a 3:1 gear ratio and pulling capacity of 300kg. Comes with 6m x 4mm cable and S hook. Suitable for pulling a small Tinny boat trailer or large Jet ski trailer. A compact design with Dacromet finish. Unit weight: 2.52kg NATA tested.
- SMW005W** Tinny winch with a 3:1 gear ratio and pulling capacity of 300kg. Comes with 4.5 metre webbing strap and S hook. Suitable for pulling a small Tinny boat trailer or large Jet ski trailer. A compact design with Dacromet finish. Unit weight: 2.3kg NATA tested.
- SWM007R** Tinny winch with a 3:1 gear ratio and pulling capacity of 300kg. Comes with 6m of HMPE dynema rope with S hook and removable handle. Direct lift capacity is 300kg and is suitable for a small tinny boat or large Jet Ski trailer. Unit weight: 2.15kg. Dacromet finish and NATA tested.
- MW212C** Marine winch with a 3:1 gear ratio and pulling capacity of 500kg. Single speed winch that comes with 6m x 4mm cable and S hook. Unit weight: 4.44kg. Dacromet finish. NATA tested.
- MW202W** Marine winch with a 3:1 gear ratio and pulling capacity of 500kg. Comes with 6m of webbing and S hook. Unit weight: 4.33kg. Dacromet finish and NATA tested.
- MW201R** Marine winch with a 3:1 gear ratio and pulling capacity of 500kg. Comes with 6m HMPE dynema rope and S hook. Unit weight: 4.12kg. Dacromet finish and NATA tested.
- MW214C** Marine winch with a 3:1 gear ratio and pulling capacity of 500kg. Single speed winch that comes with 6m x 4mm cable and S hook. Unit weight: 4.44kg. Dacromet finish. NATA tested.
- MW204W** Marine winch with 5:1 gear ratio and pulling capacity of 700kg. Comes with 6m of webbing and Snap hook. Unit weight: 4.55kg. Dacromet finish and NATA tested.
- MW203R** Marine winch with 5:1 gear ratio and pulling capacity of 700kg. Comes with 6m of HMPE dynema rope with Snap hook. Unit weight: 4.33kg. Dacromet finish and NATA tested.
- MW220C** Marine winch with a 10:1/5:1/1:1 gear ratio and pulling capacity of 1000kg. Comes with 7.5m x 6mm cable and Snap hook. Unit weight: 5.98kg. This 3 speed winch is suitable of pulling boats up to 20 feet in length. Dacromet finish and NATA tested.



- MW208W** Marine winch with a 10:1/5:1/1:1 gear ratio and pulling capacity of 1000kg. Comes with 7.5m webbing strap and Snap hook. Unit weight: 5.39kg. This 3 speed winch is suitable for pulling boats up to 20 feet in length. Dacromet finish and NATA tested.
- MW207R** Marine winch with 10:1 / 5:1 / 1:1 gear ratio and pulling capacity of 1000kg. Comes with 7.5m HMPE dynema rope and snap hook. Unit weight: 5.15kg. Dacromet finish. NATA tested.
- MW223C** Marine winch with a 15:1/5:1/1:1 gear ratio and pulling capacity of 1500kg. Comes with 7.5m x 7mm cable and Snap hook. Unit weight: 7.3kg. This 3 speed winch is suitable for pulling boats up to 20 feet in length. Dacromet finish and NATA tested.
- MW209R** Marine winch with a 15:1/ 5:1 / 1:1 gear ratio and pulling capacity of 1500kg. Comes with 7.5m HMPE dynema rope and snap hook. Unit weight: 6.5kg. Dacromet finish and NATA tested.



Brake winches

- BW230C** Brake winch with a 5:1 gear ratio and direct lift capacity of 300kg. Comes with 7.5m x 5mm cable and Snap hook. The self actuating ratchet mechanism ensures the suspension of loads and 'jerk-free' movements when lowering a load under pressure. Unit weight: 5.56kg. Dacromet finish. NATA tested.
- BW260C** Brake winch with a 10:1 gear ratio and direct lift capacity of 500kg. Comes with 7.5m x 6mm cable and Snap hook. The self actuating ratchet mechanism ensures the suspension of loads and 'jerk-free' movements when lowering a load under pressure. Unit weight: 6.09kg. Dacromet finish. NATA tested.



Winch cables, straps, hooks and spares

- WC4MM** 4mm x 6m winch cable and hook - 500kg
- WC5MM** 5mm x 7.5m winch cable with snap hook - 800kg
- WC6MM** 6mm x 7.5m winch cable with snap hook - 1000kg
- WS6M** 6m winch strap with s hook - 1000kg
- WR5MM** 5mm x 6m winch rope (HMPE) with s hook - 1500kg
- WR7MM** 7mm x 7.6m winch rope (HMPE) with snap hook 2650kg breaking capacity
- WR8MM** 8mm x 7.6m winch rope (HMPE) with snap hook 3750kg breaking capacity
- WH22** 22mm hex head winch handle



Jerry can holders

- JCH1 Jerry can holder zinc plated for 20L cans.
Inside dimensions 370 x 180 x 295mm (depth)
- JCH1-FL Front load jerry can holder zinc plated for 20L cans.
Inside dimensions 370 x 180 x 295mm (depth)



JCH1



JCH1-FL

Spare wheel carriers

- SWC-FDHT Ford and HT pattern spare wheel carrier. Comes with mounting plate and bolts to fit to chassis.
- SWC-FDHT-L Heavy-duty Ford, HT and 6 stud pattern spare wheel carrier. Comes with mounting plate and bolts to fit to chassis.
- SWC-LC5 LandCruiser 5 stud pattern spare wheel carrier
- SWC-FD Ford pattern galvanised spare wheel carrier
- SWC-HT HT pattern galvanised spare wheel carrier
- SWCHTTM Top mount HT stud pattern spare wheel carrier
- SWC-UBOLT U-bolt for spare wheel carrier
- TRF35 Trailer rescue kit slimline bearing
- TRH32 Trailer rescue kit LM bearing



SWC-HT



SWC-UBOLT



SWCHTTM



SWC-FDHT



SWC-FDHT-L



TRF35

Gas bottle holders

- GBH-4.5 4 to 4.5kg gas bottle holder, bolt/weld-on type zinc plated
- GBH-9 9kg gas bottle holder, bolt/weld-on type zinc plated
- GBHA-4.5 4kg adjustable galvanised gas bottle holder with zinc plated brackets for weld-on
- GBHA-9 9kg adjustable galvanised gas bottle holder with zinc plated brackets for weld-on
- GBHA-4.5RI Protective rubber insert to suit 4.5kg adjustable gas bottle holder. Rubber protects gas bottle against wear from the steel.
- GBHA-9RI Protective rubber insert to suit 9kg adjustable gas bottle holder. Rubber protects gas bottle against wear from the steel.



GBH-4.5

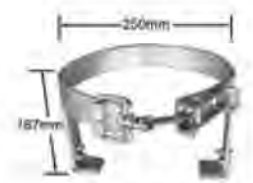

GBHA-4.5



GBH-9



GBHA-9

Caravan steps

- SGSPG Single step galvanised
- DBSP Two stage folding double step zinc finish



SGSPG



DBSP

Tailgate hardware

MTLOCKSS	Stainless steel T latch handle
GC15Z	Gate catcher zinc plated
LP6	Linchpin 6mm
LP8	Linchpin 8mm
LP10	Linchpin 10mm
RCLIP	R clip
TGAB19	Tailgate anti-rattle latch bolt type comes with nyloc nut
TGAW19	Tailgate anti-rattle latch weld-on type
TGC60B	Tailgate catches 1 pair – left and right sides
TGH100	Tailgate hinge 20mm diameter x 100mm length weld-on
TGH100G	Tailgate greaseable weld-on hinge 16mm diameter x 100mm
TGH50	Tailgate hinge 13mm diameter x 60mm length weld-on
A86A	Tailgate over centre adjustable latch with padlock facility.
RT-LASHRING	Lashing D-ring 124mm x 115mm



GC15Z



TGH100



LP6



TGH50



TGAB19



TGAW19



A86A



TGH100G



R CLIP



MTLOCKSS

D shackles

DS6	6mm D shackle
DS8	8mm D shackle
DSS8B	8mm D shackle stainless
DS10	10mm D shackle
DSS10B	10mm D shackle stainless
DS12	12mm D shackle
DSS12B	12mm D shackle stainless
DS16	16mm D shackle
DS20	20mm D shackle



DSS8B

Lanolin

EG350L	Enviro Gold lanolin liquid 350g aerosol spray
EG500L	Enviro Gold heavy-duty lanolin liquid 500ml trigger spray
EG1L	Enviro Gold heavy-duty lanolin liquid 1 litre flask
EG5L	Enviro Gold heavy-duty lanolin liquid 5 litre flask
EG500G	Enviro Gold lanolin grease 500g tub
EG2.5G	Enviro Gold lanolin grease 2.4kg tub
EG4G	Enviro Gold lanolin grease 4kg tub



Zinc sprays and anti-seize

- WO100 2 in 1 silver zinc 400g aerosol spray
- WO101 Industrial grade liquid zinc 400g aerosol spray
- WO103 2 in 1 black zinc 400g aerosol spray
- WO401 Anti-seize 450g brush top lid



Wheel chocks and holders ** Larger sizes available.*

- 10719 Rubber wheel chock 120mm (H) x 100mm (W) x 205mm (L)
- 10719WCH Stainless steel wheel chock holder for 2 x 10719 chocks



10719

10719WCH

Safety equipment

Fire extinguishers and blankets *Larger fire extinguishers available.*

- FE15DC Fire extinguisher with bracket and hose 1.5kg dry chemical powder
- FE1DC Fire extinguisher 1kg dry chemical with bracket
- FS100 Fire blanket 1.0m x 1.0m
- FS120 Fire blanket 1.2m x 1.2m
- FS128 Fire blanket 1.2m x 1.8m



FE15DC



FE1DC

First aid kits

- 856603 First aid kit handy soft pack green
- 856623 Handy deluxe first aid kit
- 854318 Remote area / 4WD first aid kit



856603



856623



854318

Safety triangles

- 84200 Emergency safety triangle set of 3
Heavy-duty container includes 3 safety triangles made to international standards of reflectivity, stability and operating markings. Complies with Australian standards. Features – Non-skid rubber feet keeping the triangle in place in high wind and passing traffic. Placement instructions permanently printed on case and triangle. Provides reflectors with high reflective capability for night time use. Fluorescent inner triangle warns daytime traffic. No tools required to setup. Complies with Australian Standard AS3790.



DISCLAIMER

The information contained in this catalogue is for general information purposes only and is provided by Trailer Spares Direct, a registered business of Direct Source Australia Pty Ltd. While we endeavour to keep the information up to date and correct at the time of print, we make no representations or warranties of any kind, express or implied, about the completeness, accuracy, reliability, suitability or availability with respect to the catalogue or the information, products, services, or related graphics contained on the catalogue for any purpose. Any reliance you place on such information is therefore strictly at your own risk. You need to make your own enquiries to determine if the information or products are appropriate for your intended use.

In no event will we be liable for any loss or damage including without limitation, indirect or consequential loss or damage, or any loss or damage whatsoever arising from loss of data or profits arising out of, or in connection with, the use of this catalogue.

COPYRIGHT NOTICE

This catalogue and its contents are the copyright of Direct Source Australia Pty Ltd also trading as Trailer Spares Direct – © 2017. All rights reserved.

Any redistribution or reproduction of part or all of the contents in any form is prohibited other than the following. You may print or download contents to a local hard disk for your personal and non-commercial use only. You may copy some extracts only to individual third parties for their personal use, but only if you acknowledge the catalogue as the source of the material.

You may not, except with our express written permission, distribute or commercially exploit the content. You may not transmit it or store it on any other website or other form of electronic retrieval system.

TERMS OF SALE, WARRANTIES AND RETURNS

Trailer Spares Direct and Direct Source Australia Pty Ltd terms of sale are in accordance with the Australian Consumer Protection legislation. Our terms of sale, information on warranties and returns can be found on our website: www.trailersparesdirect.com.au.

Alternatively for more information please contact the office on 07 3205 8846.

Please be aware custom made parts are non-refundable, these include, but are not limited to: axles made to size, overlay and drop axles, assembled axles.



HYDRALINE
Flexible Stainless Steel Braided Brake Line

TRAILER SPARES DIRECT
for trailers under 4.5 tonne

TRAILER SPARES DIRECT

a division of Direct Source Australia Pty Ltd

Ph: 07 3205 8846

info@trailersparesdirect.com.au
www.trailersparesdirect.com.au

ABN: 54 126 430 840

LOAD FORCE
AUSTRALIA'S RV TRAILER SPARES