



## INSTRUCTION MANUAL

**Models:** FGPH061; FGPH062; FGPH063; FGPH064; FGPH065; FGPH066; FGPH070; FGPH071

**DBK Technitherm Limited**

Unit 11, Llantrisant Business Park, Llantrisant, CF72 8LF, Wales, United Kingdom

Tel: +44 (0) 1443 23 79 27 Fax: +44 (0) 1443 23 78 67 Email: [info-uk@dbk-group.com](mailto:info-uk@dbk-group.com) Web: <http://drymatic.com>

Patented in Australia (AU2009272484), United States (US8720080 & US9015960), Great Britain (GB2462066 & GB2488873) and patents pending in Europe (EP2307838 & EP2498036).

All worldwide design rights and copyright reserved.

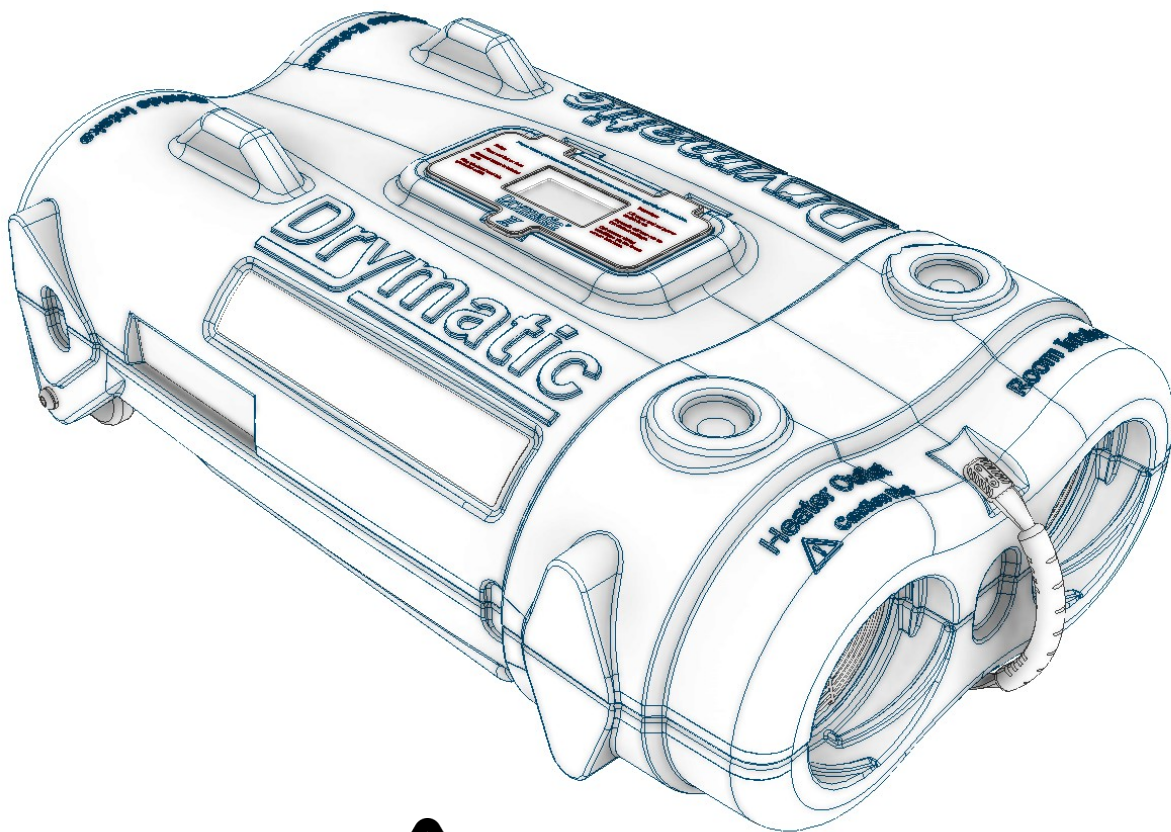

### WARNING!

Ensure that you have read and understood this manual before operating the machine.

Do not overload sockets or extension leads - Check power ratings before use.

Risk of electric shock - Do not open the unit or try to reach through the grills.

Hot surfaces - Do not touch heater outlet or grill whilst product is in operation. Once stopped allow the unit to cool down before touching.

Do not block or twist ducts. This could cause the unit to overheat or hinder performance.

Only try to use this machine flat or on it's side.

Product for indoor commercial use only.

# Congratulations on Your Purchase!

Congratulations and thank you on your purchase of a Drymatic product! In order to get the most out of your Drymatic please take the time to read this user guide and familiarise yourself with the machines operation and features.

## Contents:

Warranty:	1	Storage and Transport:	11
Safety and Warnings:	2	Maintenance:	12
Introduction:	3	Trouble Shooting:	14
Component Identification:	3	Replacement Parts:	14
Quick Setup:	5	Model Identification:	15
Advanced Settings:	7	Product Specification:	15
Setup Tips:	9		

## Warranty Information:

Please complete and mail, fax or email your warranty registration card complete with bill of sale/receipt to activate your warranty. DBK Technitherm offers a standard one year warranty from date of purchase on Drymatic and an additional four years on the rotomoulded housing. Contact details can be found on the cover of this instruction manual. Please see the component identification section to locate your model and serial number.

### Drymatic Limited Warranty Card

Drymatic Model Number FGPH Serial Number \_\_\_\_\_

Date of Purchase     /     /     Purchased From \_\_\_\_\_

Title \_\_\_\_\_ First Name \_\_\_\_\_ Surname \_\_\_\_\_

Address \_\_\_\_\_

Phone ( \_\_\_\_\_ ) \_\_\_\_\_ Email \_\_\_\_\_

Signature \_\_\_\_\_ Date     /     /

## IMPORTANT SAFETY INFORMATION:



**HANDLE WITH CARE!**



**KEEP AWAY FROM CHILDREN!**



**RISK OF ELECTRIC SHOCK!**



**RISK OF BURNS!**

- Do not alter or modify your Drymatic in any way. Use only replacement parts approved by DBK, modifications/repairs not covered in the maintenance section of this manual and the use of unapproved parts will void any remaining warranty. Contact your local Drymatic distributor for assistance.
- Check hoses for wear and damage, replace when needed. Heater hose must be rated to 100°C (212°F).
- Product for indoor commercial use only. It must be kept dry at all times away from rain, water or snow.
- Handle the unit carefully. Always operate the unit on a flat stable surface. Do not drop, throw or place the unit in area it may fall. Rough handling may damage the unit, create dangerous operating conditions and will void the warranty.
- Lift within your limits. Drymatic weighs up to 32kg (71lb), seek assistance if necessary. Please see transport section.
- Never pull or lift the product via the mains cord.
- Children of less than 12 years should be kept away unless continuously supervised.
- This appliance can be used by children from 16 years and above and persons with reduced physical, sensory or mental capabilities or lack of experience and knowledge if they have been given supervision or instruction concerning use of the appliance in a safe way and understand the hazards involved. Children shall not play with the appliance. Cleaning and user maintenance shall not be made without supervision.
- Children aged from 12 years and less than 16 years shall only switch on/off the appliance provided that it has been placed or installed in its intended normal operating position and they have been given supervision or instruction.
- If the supply cord is damaged, it must be replaced by the manufacturer, its service agent or similarly qualified persons in order to avoid a hazard. Always grasp the plug (not the cord) to unplug.
- To provide a continued protection against electric shock, connect to properly grounded outlets only. Do not use an adaptor, never cut off third prong.
- Do not overload sockets or extension leads - Check power ratings and condition before use. The heater shall not be located immediately below a socket outlet.
- The unit must be operated on a matched voltage circuit protected by a Ground Fault Circuit Interrupter (GFCI) device.
- Always unplug the unit before transporting, servicing and cleaning or whilst the unit is not in use.
- **WARNING:** Do not block heater or twist any ducts. This will cause the unit to overheat and limit airflow.
- **WARNING:** This heater is equipped with a device to control the room temperature that could require training to operate. Do not use this heater in small rooms when they are occupied by persons not capable of leaving the room on their own, unless constant supervision or instruction is provided.
- Do not touch heater outlet, grills or hose whilst product is in operation as surfaces will become hot and cause burns. Once stopped allow the unit to cool down before touching. Do not open or try to reach through grills. Particular attention has to be given where children and vulnerable people are present.
- Keep away from open flames and heat sources or where vapours from gasoline, solvents, thinners or any other flammable materials may be present.

## Introduction:

Drymatic is an intelligent heat drying and air exchange system designed to dry a room as quickly as possible. By constantly optimising and exchanging moist air with warm dry air in a controlled manner Drymatic greatly speeds up the drying process whilst making it more efficient. The addition of heat and controlled air exchanges also increases the performance of conventional drying equipment.

### How it works:

Drymatic has two modes of operation: Recirculation and Exhaust Mode. In recirculation mode air in the room is continuously heated up until either a temperature or humidity limit is reached. Raising the temperature of the air allows it to hold more water which promotes evaporation. This means that more moisture will be drawn out of the wet structure/contents of the room and retained in the air. In exhaust mode this now moist and humid air is then exchanged and replaced with dry air which has been heated before it enters the room. By continuously monitoring the temperature and humidity of the air Drymatic can cycle between these modes to maximise the amount of water removed from the room.

### Features:

- **High performance drying with monitoring system to maximise efficiency.**
- **Rotomoulded housing that is strong, portable and stackable.**
- **Quick-fix fast and easy ducting system.**
- **Simple power up and go operation.**

## Component Identification:

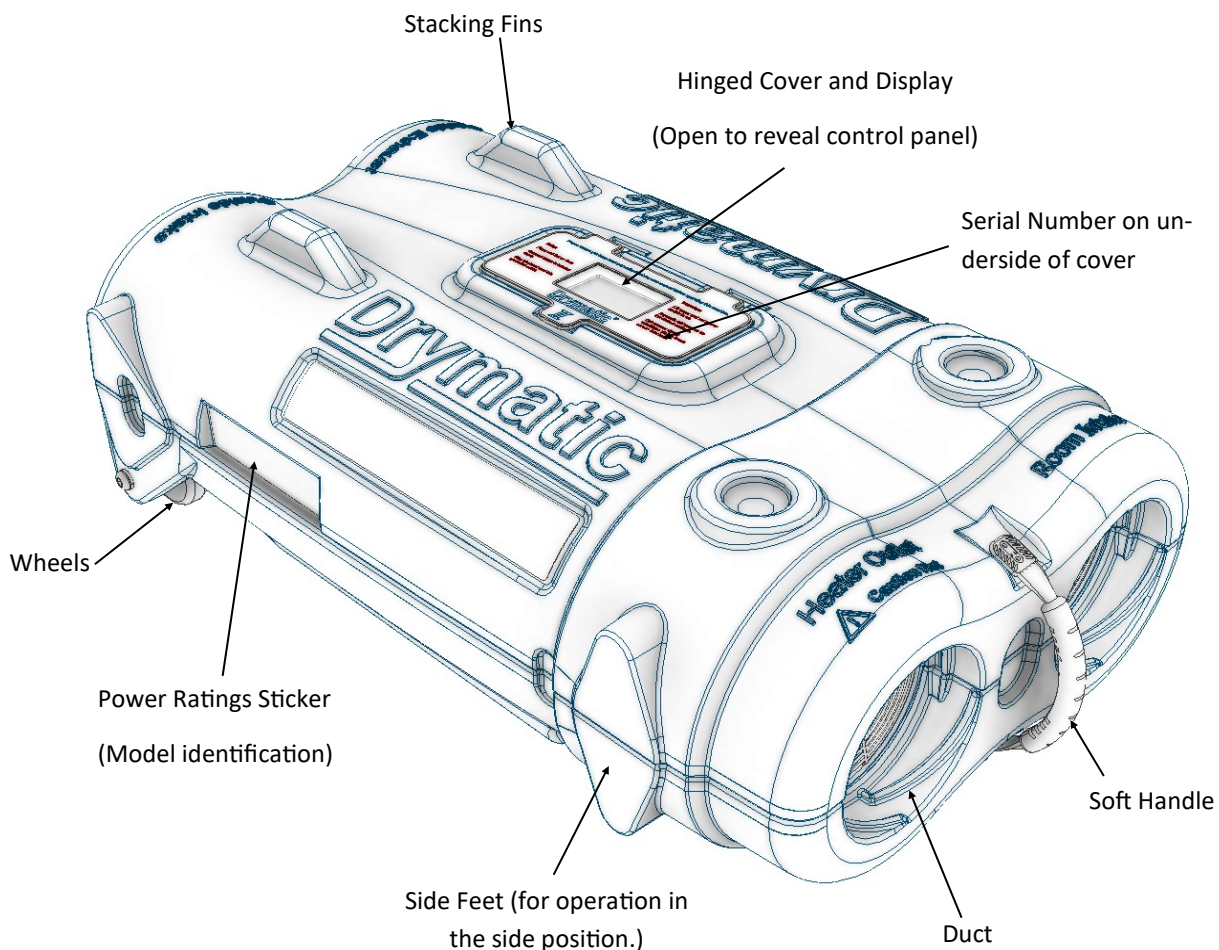



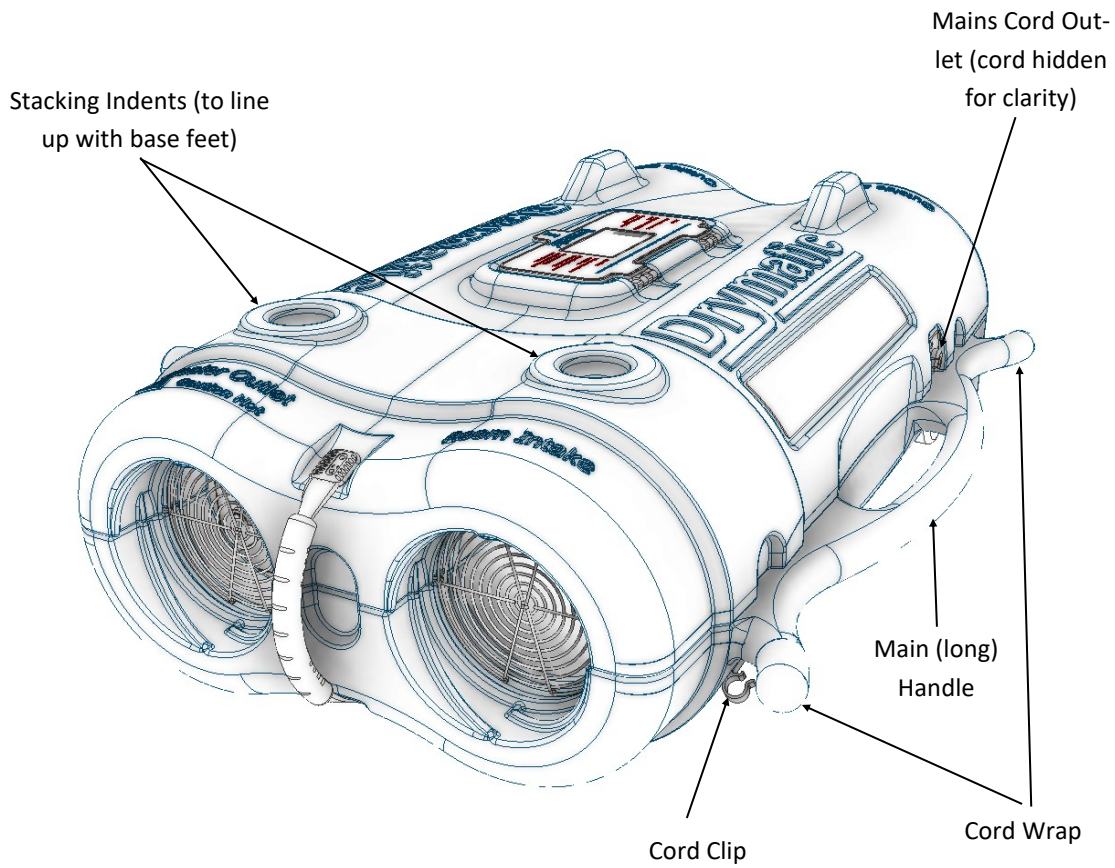

**Control Panel Parts**

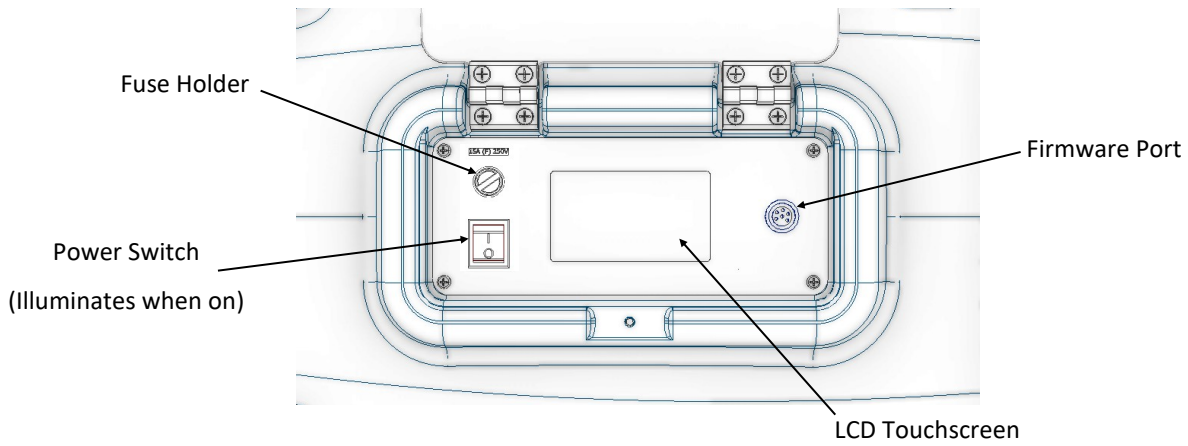

**Quick-fix Duct Parts**

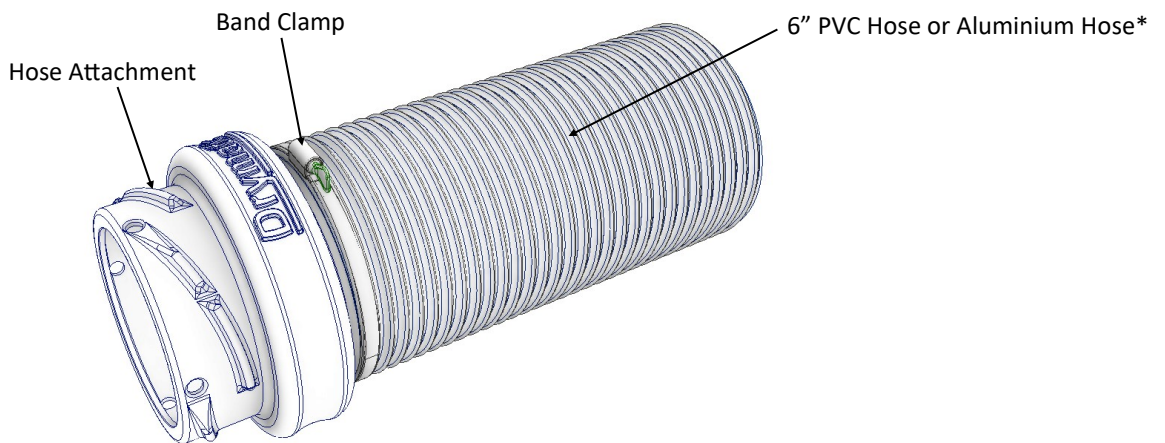

\*Hoses can be cut to any length is required. Minimising the length of hoses (particularly the heater) will improve performance.

## Quick Set Up:

To quickly set up Drymatic: (Instructions can also be found on the screen cover).

- 1) Place the unit flat or in the side position on the floor as close to the centre of the Drying area as possible.
- 2) Connect at least three quick-fix ducts, inserting them into the labelled ports (see below) and rotating clockwise until tight.
- 3) Plug the power cord into a grounded outlet.
- 4) Lift the cover and switch on the machine with the red power switch.
- 5) Press the green play button on the touch screen.

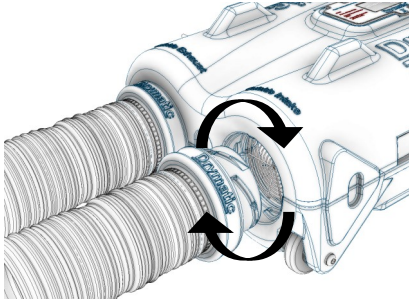

2) Connecting the Ducts

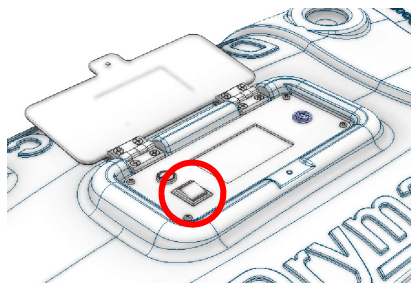

4) Identifying the red power switch

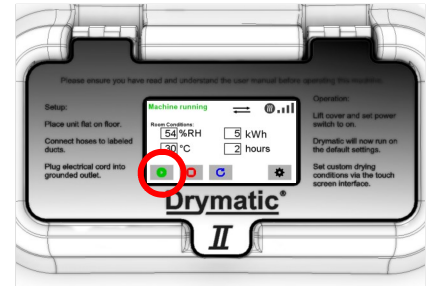

The display when running

Drymatic will now run on the default settings. The cover can be closed and the machine left to run on it's own. Try to keep the area isolated with all doors and windows shut and take note of the initial relative humidity. Continue to check the room and humidity values until you consider the room 'dry' and then use the red power switch to turn off the machine.

**Note that the reset button should be used before the next job is started, see 'About the Memory' in the 'Advanced Settings' section for more information.**

### Duct Identification:

**Outside Exhaust** - used to purge moist air from the room.

Should be directed outside as far away from the drying area as possible.

**Room Intake** - used to pull in moist air from the room.

Can be positioned anywhere in the room but must be positioned away from the heater outlet. Aim to create a flow of air through the drying area.

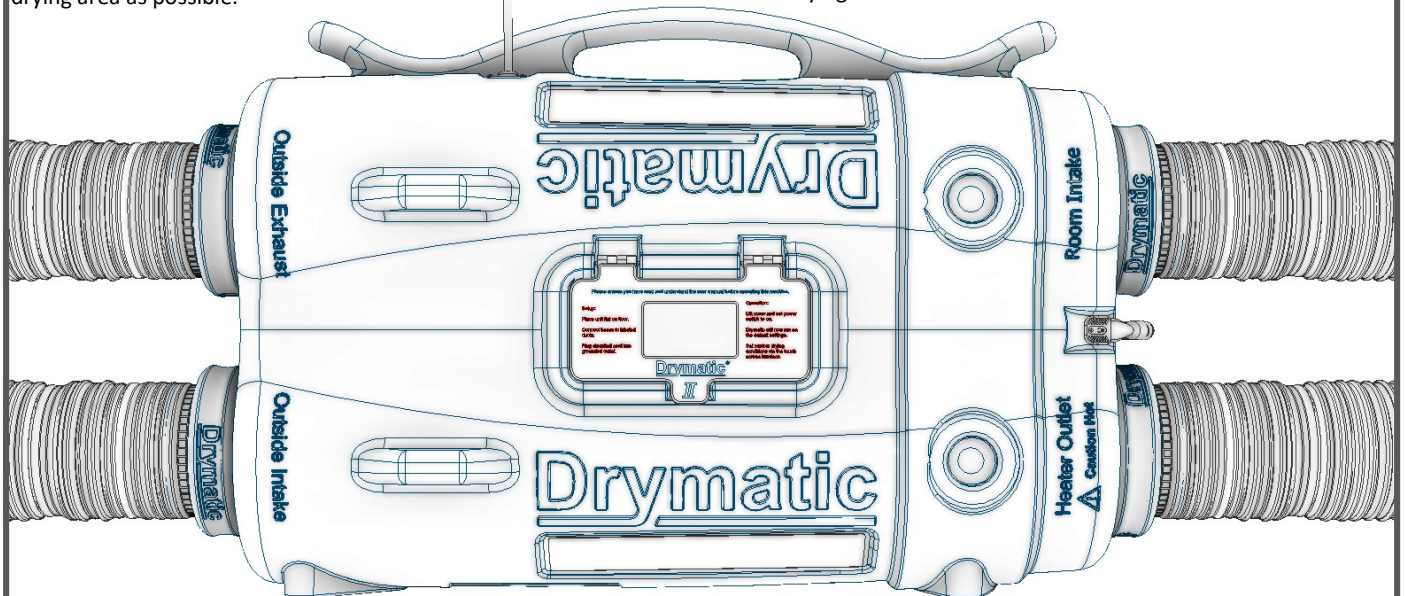

**Outside Intake** - used to pull fresh air into the room.

Normally directed outside the room to a fresh source of air. (Note - keep away from Outside Exhaust hose to avoid recirculating wet air).

**Heater Outlet** - Expels warm air into the room - **USE HIGH TEMP OR ALUMINIUM HOSE! DO NOT LAY ON CARPET/SOFT FURNIATURE!**

Should be aimed at the most affected area or positioned centrally in the room, you can also run the machine with no hose here at all\* - CAUTION - This outlet can get hot and should not be touched until it has adequate time to cool down.

## Display Layout:

When running the display will show the following information and controls:

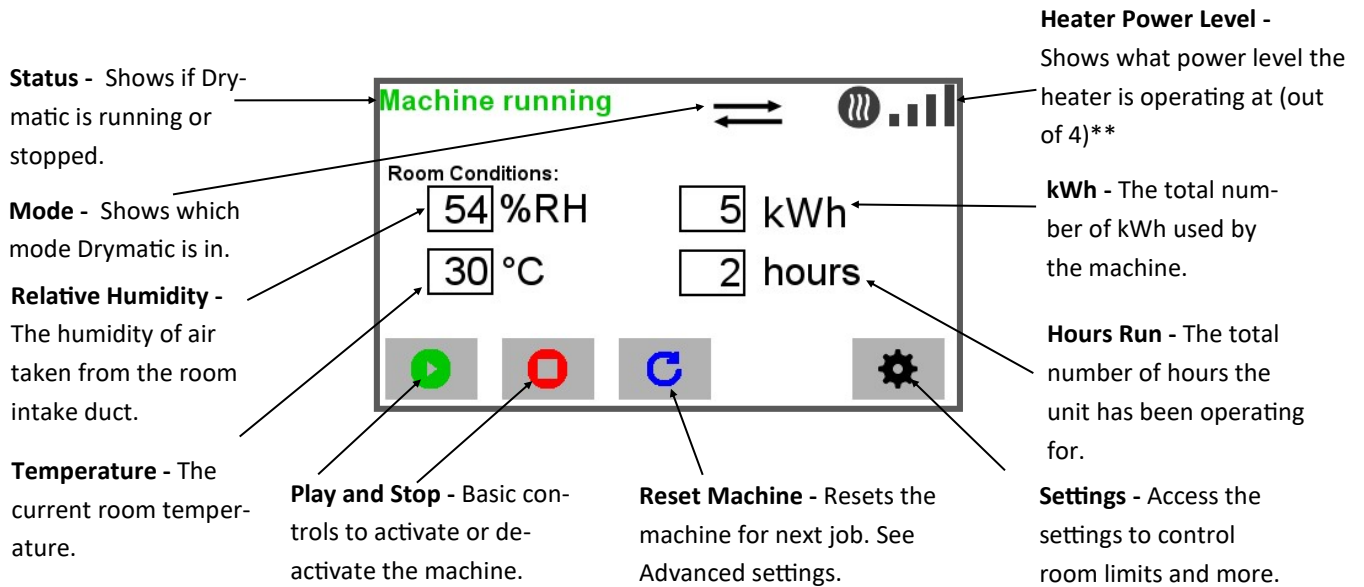

\*\*Heater power levels are determined by software and sensors to allow air out to fall between room limits and provide safe operation. The bars here serve as an indication of how the machine is performing. Conditions such as low room limits, high ambient temperatures, low fan speed and duct blockage may limit the heaters power level.

## Example Set Up:

The diagram below shows an example set up for a small room with windows. A wooden panel is used to seal the window leaving the room and all hoses are directed away from one another. Always try to minimise the length of the heater hose or avoid using it if possible.

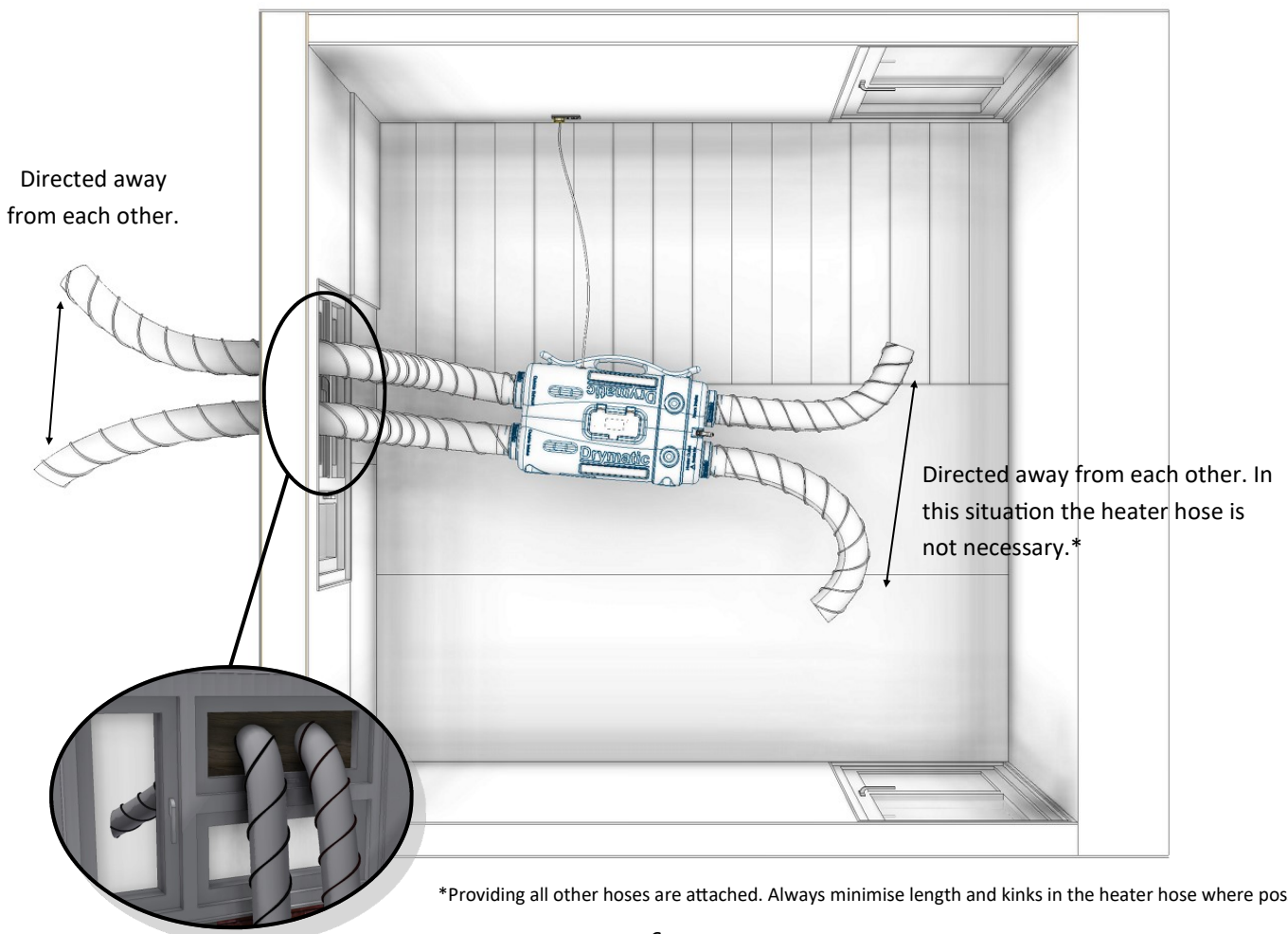



## Advanced Settings:

Drymatic has four control buttons along the bottom of the screen, Play, Stop, Reset and Settings. The top ribbon shows the machine status, in any situation where the machine is stopped the play button will restart it from where it previously left off. Similarly the stop button will put the machine on hold without the need to power it down. In order to correctly understand how the reset button functions please see 'About the Memory' below.

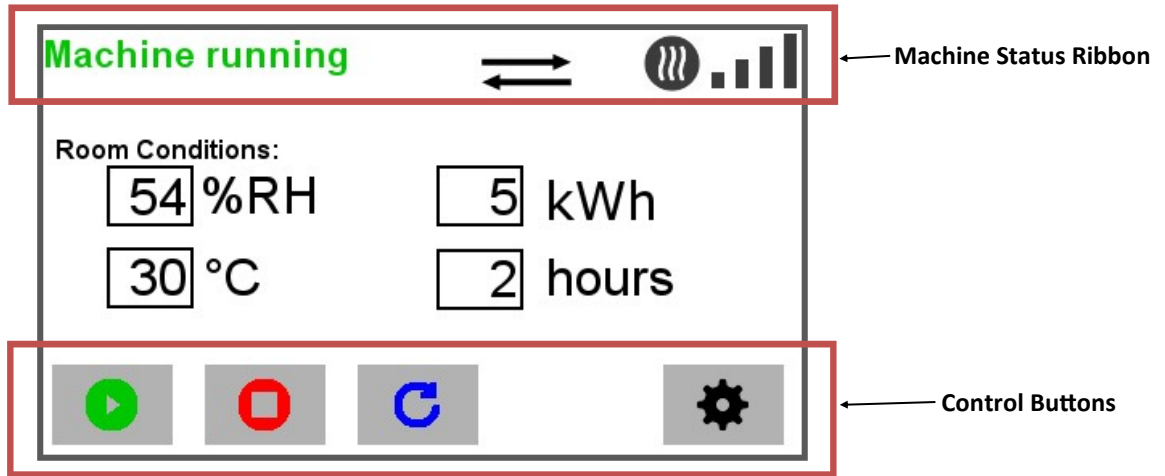

Touching the settings button brings you to the advanced menu, here you have complete control of the room conditions, fan speed, units and operation modes. Once you have finished you will need to press play again to restart the machine (accessing the settings will cause the machine to stop).

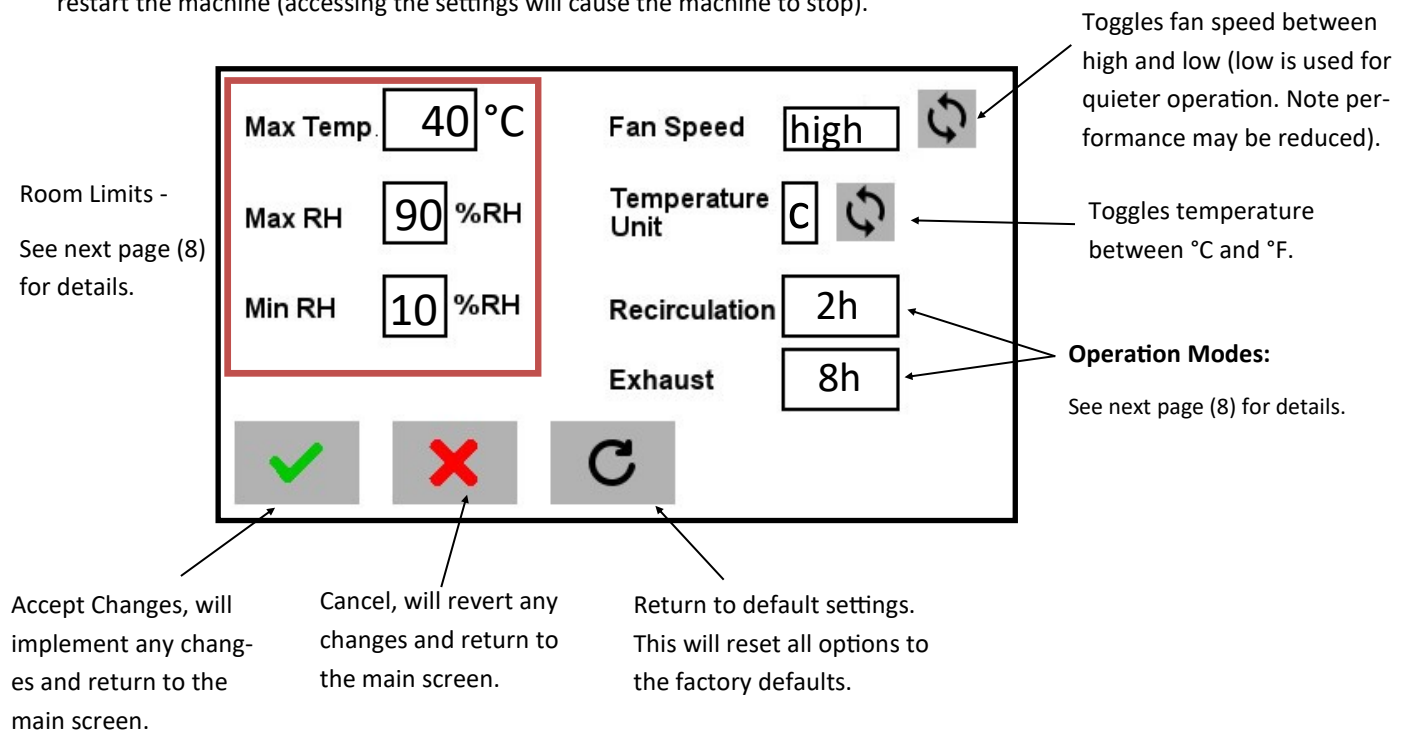

**About the Memory** - Drymatic has a built in memory allowing it to continue and restart jobs even if power is lost or removed. This ensures that the machine doesn't forget kWh and hours data and continues on the same point of it's drying cycle. There are two separate memory banks that can be reset independently.

**Job Memory** - Keeps track of where the machine is in the drying cycle and all kWh/hours data - This data should be reset at either the start of the new job or end of the previous job to ensure that the next jobs starts fresh. This can be reset from the main display, failure to do so will slow the drying time and could cause confusion with data.

**Settings Memory** - Remembers all of the user settings such as room limits, fan speed, units and operation modes. These can be reset to the default values via the settings page but will not be reset with the job. If using the machine after someone else you should always ensure that the appropriate settings have been chosen.



## Changing the Room Limits:

In some situations high temperatures, high humidity or even a very low humidity may not be desirable, if this is the case the room limits can be adjusted manually to suit.

Touching any of the values for the room limits will allow you to change them. An edit box will appear with different increments that can be pressed to change the value. Once you are happy with the value press the tick button to confirm, if you wish to cancel the changes press the cross. Remember that the reset button on the settings page will restore all room limits to the factory defaults. An outline of the variable room limits can be found below.

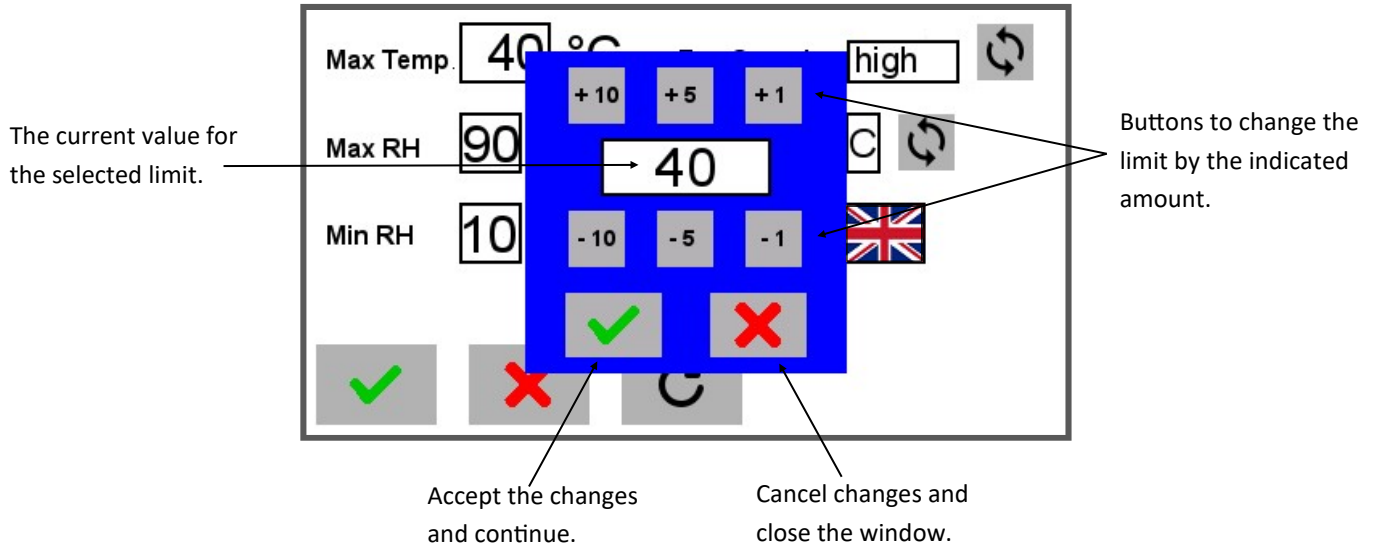

**Max Temp** - This is the maximum temperature the room can reach, higher temperatures should speed up the drying process. Please note that by default on some machines this is limited to 40°C (104°F) however can be increased to up to 50°C (140°F) depending on how the machine is used.

**Max RH** - This is the maximum relative humidity the room can reach, when in recirculation mode the machine will aim to increase the humidity by extracting water from the room and into the air before exhausting it out of the building. Reducing this limit will cause the machine to switch mode more frequently however may not be extracting as much moisture as it possibly could each cycle. Higher values will generally correspond to faster drying.

**Min RH** - This is the minimum relative humidity the room can reach, effectively a limit on how 'dry' you want the room to get. Once this target has been reached the machine will mainly run in exhaust mode with the aim to keep this humidity constant.

## Adjusting Operation Modes:

In some situations the timing lengths can be increased/decreased due to the surrounding conditions or user requirements. Operation mode values can be changed between 1 - 24hours (1 Hour increments only). Each operation can be changed individually. E.g. Recirculate can be set at 12h & Exhaust mode at 4h.

If recirculate mode is at 0h, the machine will run in exhaust mode constantly. Likewise, if exhaust mode is at 0h, the machine will run in recirculation mode constantly.

Note: If one of the operation modes is set at 0h, then the value of the opposite mode is irrelevant as the machine will constantly run in that mode.

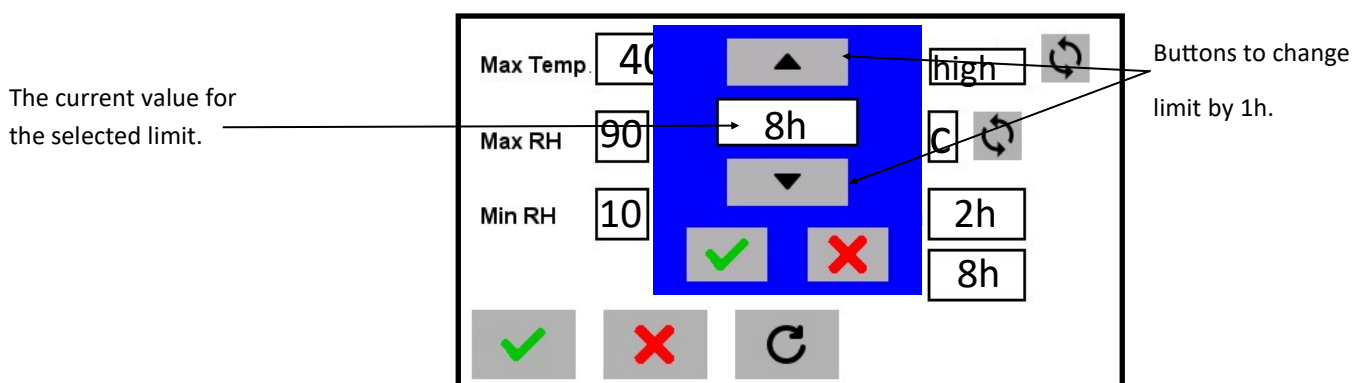

## The Machine Status Ribbon:

The machine status ribbon shows the machines current operating state, operating mode and the heater power level. This table shows most possible situations. (note that fans are always running when machine is running).

Machine Status:	Description:	Mode:	Description:	Heater Level:	Description:
<b>Machine running</b>	Machine running as normal.		Exhaust Mode - exchanging with outside air.		Full Power
<b>Machine stop</b>	Machine on hold, press play to resume.				66% Power
<b>Blockage</b>	A duct has become blocked, remove the blockage to re-start machine.		Recirculation Mode - heating room.		50% Power
					33% Power
<b>Room limits exceeded</b>	Room limits have been reached, machine will stay in exhaust mode to equalise.	(none)	Machine not in operation.		33% Power
					Heater off

## Set Up Tips:

The following guidelines should be followed to get the most out of your Drymatic. Taking the time to set up the unit correctly will give much better performance and will reduce drying times.

### Hoses -

- Keep hoses clear and as straight or smooth as possible - tight bends or blockages will restrict airflow and limit heater.
- If there is space to put Drymatic near the target drying it may be possible to run the unit with only three hoses. This will guarantee the heater is always on the highest possible power. Ensure that no hoses block the open port if they cross.
- Keep the ends of both the Outside hoses and Room hoses separate. If they are too close the unit will just be cycling round the same air limiting performance.
- Aim to create a flow of air around the room - ideally the warm air should pass all target drying areas to absorb moisture before being expelled.
- Hoses can be moved throughout the cycle to target wetter areas, this is especially useful for larger or complex rooms.
- Hoses can be cut down or they can be extended by using joiners - bear in mind that elongating the hoses will reduce the airflow. See the maintenance section if you wish to change the hose entirely. DO NOT EXTEND THE HEATER OUTLET.

### Drying Area -

- Keep the drying area sealed - any losses of heat will slow performance or allow more moisture to enter the area. In larger/open areas consider using tenting to isolate target zones. - For more info ask your Drymatic representative about Zip Wall.
- If hoses are running through open windows board the area with a wooden or cardboard panel to keep the room sealed. Cut a 150mm (6") hole in the panel to run the hose through.
- Drymatic can be used in a separate room with hoses feeding in to the drying area - this may be the only option for smaller rooms/cupboards.
- If the floor under Drymatic is wet consider moving it throughout the job. Always stop the unit before doing this.
- If there is nowhere to vent wet air consider placing it in a sealed shower cubicle. It should condense and exit via the drain.

### **Measuring, Monitoring and other Equipment -**

- Drymatic's display gives an outline of relative humidity throughout the room. To optimise the drying process we recommend using moisture meters to map the wet areas and then placing/moving the hoses accordingly. Remote monitoring can be achieved through the Drymatic Hygronet system. For more information please contact a Drymatic Sales Representative.
- When monitoring energy usage remember to reset and log the kWh and Hours run readings at the start and end of the job.
- Strategically using Drymatic with other equipment can increase performance. For example placing the Heater Outlet hose near an air mover will mean that warm air is pushed over it's target area increasing the rate of evaporation.

### **Alternative Uses -**

- Running Drymatic with no ducts will make it function like a fan heater, the settings menu can then be used to control the max temp and fan speed.
- Setting a high RH target and low temperature limit will make Drymatic run solely as an air exchange machine.
- In tight spaces the Drymatic can be run on it's side as shown in the storage section of this manual.

## Storage and Transport:

Always use the long handle to pick up the unit using two hands whenever possible. Ensure that safe manual handling guidelines are followed and request assistance if necessary. The soft handle can be used to pull Dry-matic along with it's wheels as you would a suitcase. A case is provided to store four complete hoses.

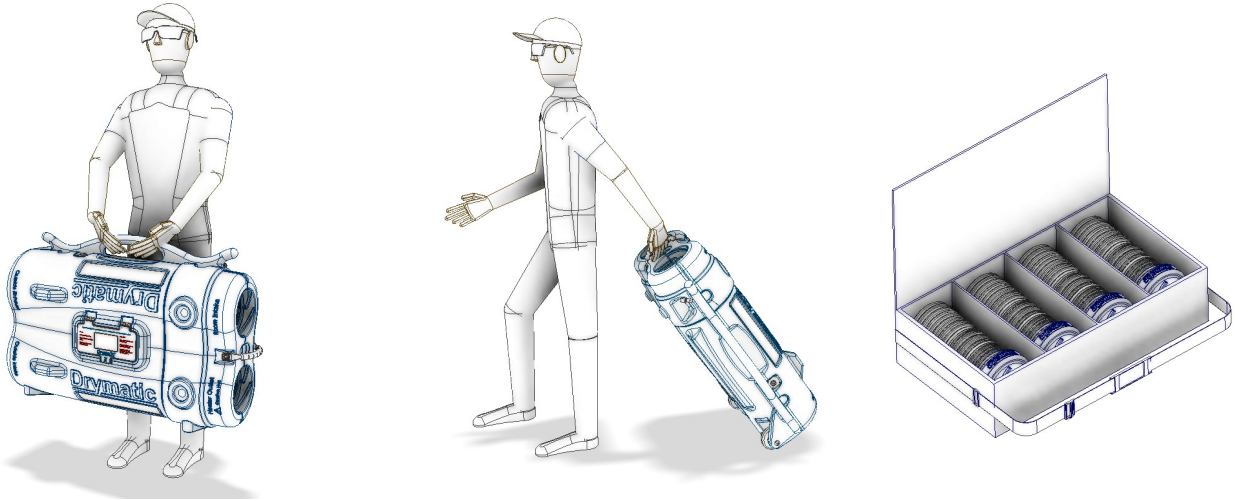

The power cord should always be removed from the electrical outlet when not in use and wrapped around the cord wrap as shown. The cord should be wrapped anti-clockwise for all models except the UK which should be wrapped clockwise. Once fully wrapped the cord can be clipped to the side of the unit. (number of wraps will vary depending on cord length)

**DO NOT PULL ON THE MAINS CORD** - this may damage the product and create a risk of electric shock.

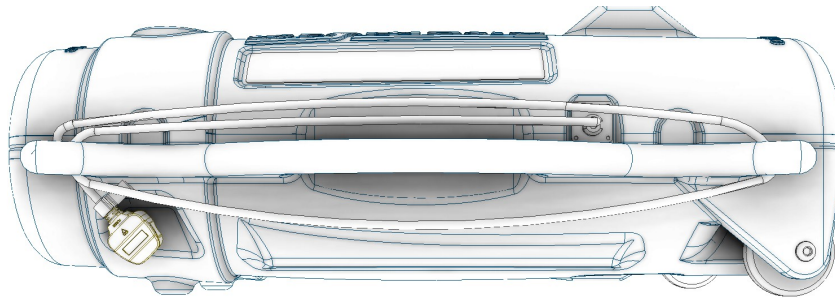

Drymatic can be stored in three different orientations as shown. It can also be stacked flat up to four units high. The unit should be kept indoors and dry. Ensure it is not exposed to rain or snow. And protected from freezing. Drymatic must be secured when in transit to prevent it sliding and potentially causing damage, harm or injury.

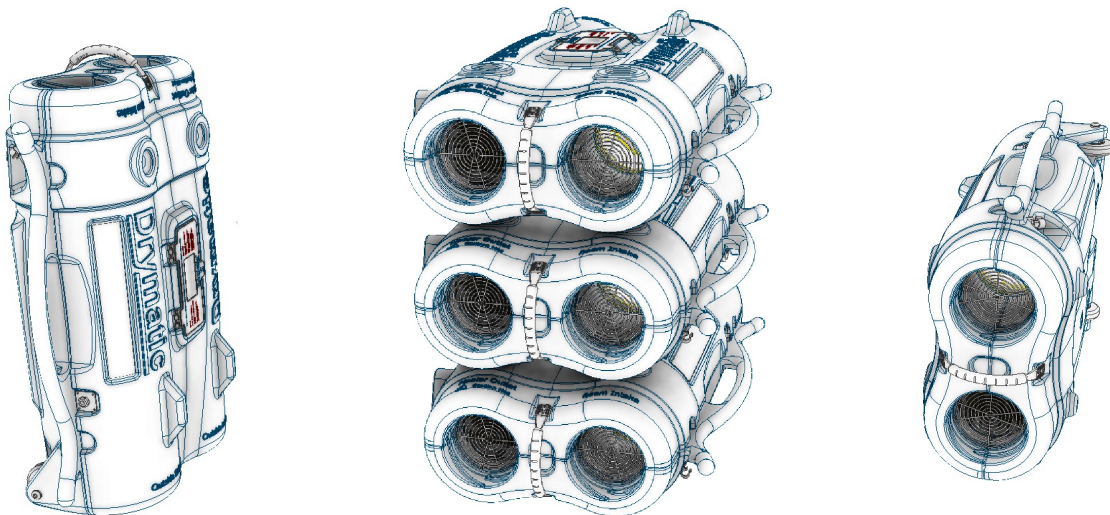

Vertical (up on wheel end)

Flat (stacked three high)

Side position (on flat edge)



## User Maintenance:

**WARNING:** The unit must be unplugged before performing any form of maintenance or cleaning.

### Before each use:

Inspect the power cord for any sign of damage. If the cord looks broken, frayed or worn do not use the product and seek a replacement.

### Cleaning:

The housing can be cleaned with a mild detergent and warm water. Do not use liquids on the grills and metal plates, these can be cleaned with a soft cloth. Never use a hose to clean the unit and ensure that it is completely dry before use.

### Replacing the Fuse:

The on board fuse can be changed by 1) opening the screen cover. 2) Using a flat head screwdriver to open the fuse holder. 3) Remove the old fuse and replace with new one. 4) Close the fuse holder and shut the cover. Replacement fuses must be 15A, 250V or 500V fast blow cartridge types, please see replacement parts section for details.

### Replacing the Mains Cord:

The mains cord should only be replaced by a qualified electrician. If you are unsure of any thing contact your Drymatic representative. When changing the cord never pull it with much force as a connection may become damaged. Only use mains cords supplied by DBK or Drymatic with the correct part number (See Table).

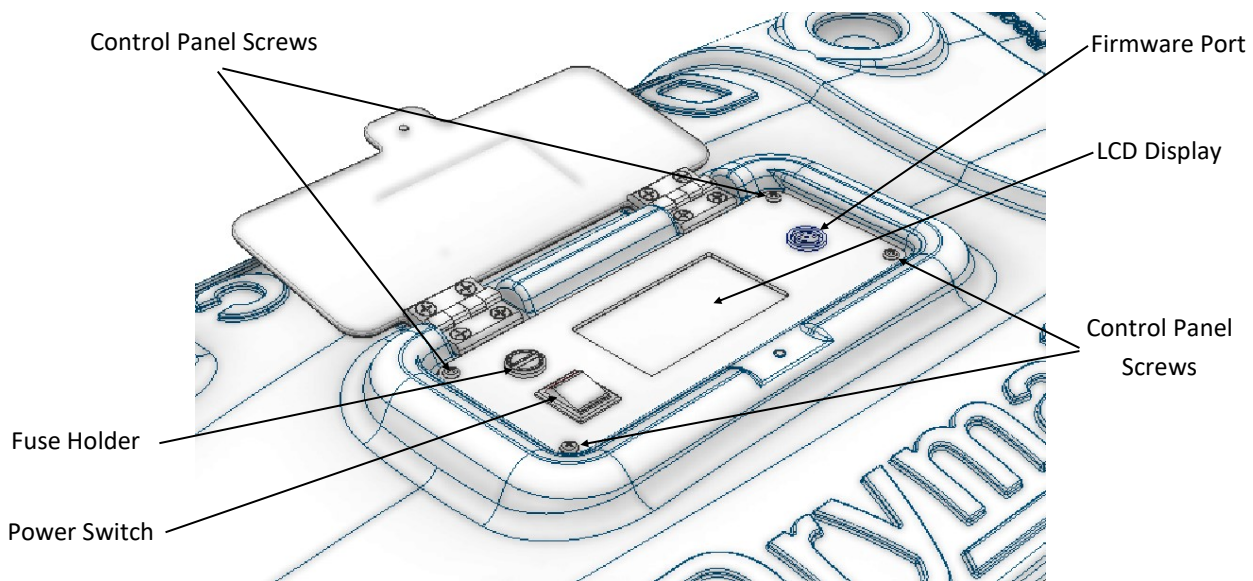

Control Panel Components

### Removing the Mains Cord

- 1: Unplug the unit and make sure that switch is in the off position.
- 2: Open the cover and remove the four screws from the Control Panel.
- 3: Gently lift the panel - note that other connections will restrict the plate. Care must be taken to prevent damage to the components, the plate only needs to be lifted slightly.
- 4: Remove the Live and Neutral mains connections from the switch. Wiggling them may help them come off.
- 5: Remove the nut from the mains grounding post, remove the mains cord ground terminal and the star washers either side.
- 6: Remove the four screws from the mains cord plate.
- 7: Gently pull the mains cord plate away from the housing, it has other connections and does not need to move far.
- 8: Squeeze the strain relief grommet at the back with pliers to release it. Slide the old mains cord out through the hole.

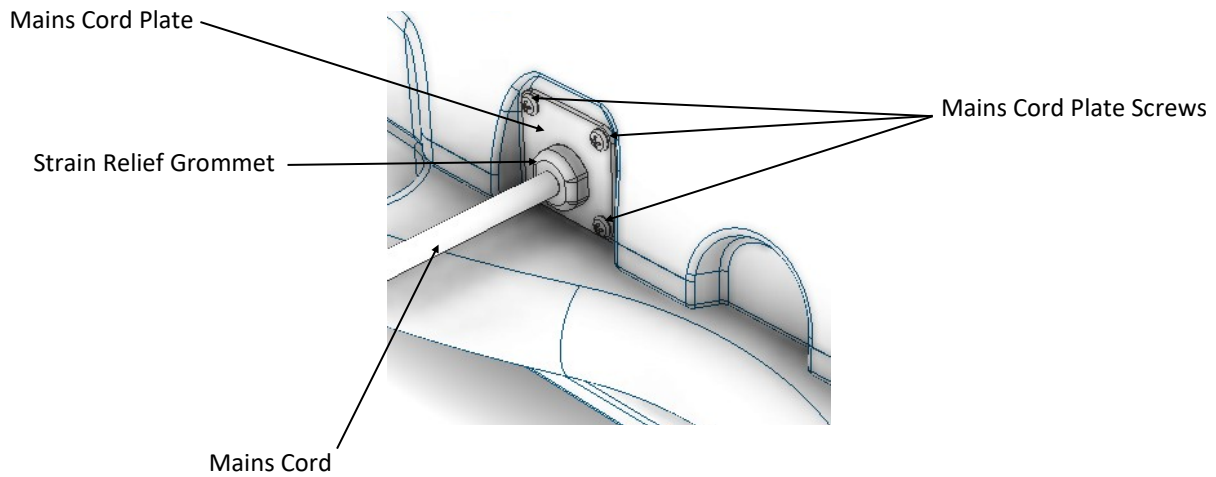

### Connecting a new Mains Cord

- 1: Feed the new cord through the mains cord plate and through the housing up to the control panel keeping it slack.
- 2: Connect the mains cord ground terminal to the mains ground post with star washers either side and a nut on top.
- 3: Connect the live and neutral connections to the switch.
- 4: Relocate the control panel and screw it back on the housing.
- 5: Squeeze strain relief grommet around the mains cord with pliers and push through mains cords plate. The cord wrap can be used to gage where to place the grommet.
- 6: Push any slack into the housing and screw mains cord plate in place. (Do not pull tight as some slack is needed for servicing)

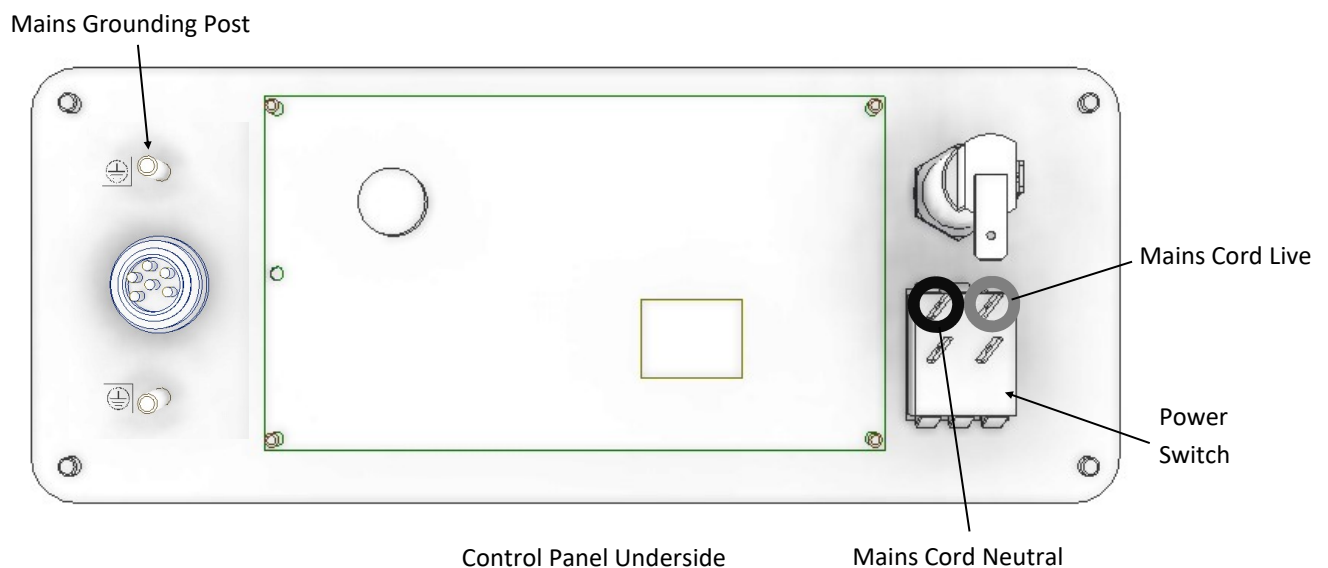

**WARNING:** Different models have different electrical ratings, only use the mains cord corresponding to your model number.

Model	FGPH061	FGPH062	FGPH063	FGPH064	FGPH065	FGPH066	FGPH070	FGPH071
<b>Mains Cord</b>	HA5253	HA5344	HA5202	HA5346	HA5347	HA5344	HA5374	HA5375

### Replacing a Hose:

Through misuse or just general wear and tear hoses may become frayed or damaged. Hoses can be replaced by unscrewing the green tab on the band clamp and pulling the hose off. To attach a new hose simply slide the hose over the attachment as far as possible then tighten the band clamp. 6m standard 6" grey PVC ducting is used however different lengths or colours may be used providing they don't restrict airflow. **WARNING:** The heater outlet hose must be rated for at least 100°C/212°F on 230V models and at least 70°C/158°F on 120V models. Hoses are available through DBK.

## Trouble Shooting:

In the event of a fault the first thing to try is powering down the machine, turning off the power at the mains and then waiting ten seconds. You can then power it up again and see if there are any improvements. If not please refer to this troubleshooting table for causes and solutions.

Fault	Cause	Solution
No power, red power switch is not illuminated when in on position.	Plug fuse blown.	Check plug fuse, if plug type doesn't have a fuse contact service.
No display, red power switch illuminates when in on position.	1) Internal fuse blown.  2) Thermal cut out activated	Check Internal fuse, it is located on the display panel next to the red power switch. Replace if necessary.  The safety cut has activated, contact service. The machine will require inspection as cut out will only activate if additional faults are present.
Old temperature/humidity readings.	Not running long enough.	Drymatic hasn't updated these values from a previous job. Wait a minute and see if they update. if problem persists reset the machine and repeat.
Frozen Display	Software error/crash	Restart and reset machine, if problem persists software may need updating. Contact service.
Vane out of alignment	Something has blocked the vane and caused it to come out of alignment.	Vane may of become damaged or forced loose. Contact service centre.
Machine resets on start-up	Too little power to start fans.	Check correct power supply is being used for your machine. If problem persists contact service.

## Replacement Parts:

Replacement parts can be ordered through your local Drymatic representative or DBK directly. Available parts include:

Hose Kits (4 Hoses with adaptors in a carry case) - FGPH072

Additional Plastic Hose Adaptors (with band clamp) - FGPH082

High Temperature PVC Hoses - DT0048, High Temperature Aluminium Hoses - DT0021

230V Mains Cords - UK - HA5343, Europe - HA5344, Australia - HA5202, USA - HA5347, CAN - HA5375

120V Mains Cords - USA - HA5346, CAN - HA5374

Fuse (15A, 500V Fast Blow Cartridge) - EC308 (Mouser: 576-0505015.MXP, Farnell: 1800116)

Additional parts available on request. Please check your correct mains cord against your model number in the maintenance section.

## Model Identification:

Your model number can be found on the side of the power rating sticker (see component identification page). Here you will find your model number and power requirements as shown below: - *Please note model number, approvals and symbols may be different for your machine.*



Model: FGPH063  
Input: 240VAC, 50Hz  
Power: 1.8kW  
Current: 7.8A  
IP Code: IP20





**WARNING!**

Risk of electric shock - DO NOT OPEN.  
Unit is for commercial and indoor use only.  
Do not pull unit by mains cord.  
Do not restrict airflow by blocking ducts or twisting hoses.



## Product Specification:

Model	FGPH061	FGPH062	FGPH063	FGPH064	FGPH065	FGPH066	FGPH070	FGPH071
Country for use	UK	Europe	Australia/NZ	USA Standard	USA High Power	Scandinavia	Canada Standard	Canada High Power
Power/kW	2.5	2.5	2.05/1.8 Refer to Label	1.4	2.5	2.05	1.4	2.5
Voltage/V	230	230	240	120	230	230	120	230
Max Current/A	10.9	10.9	8.9/7.8	11.6	10.9	8.9	11.6	10.9
Frequency/Hz	50	50	50	60	60	50	60	60
Air Movement	650m <sup>3</sup> /hr (380cfm) Recirculation Mode, 595m <sup>3</sup> /hr (350cfm) Exhaust Mode,							
Weight	32kg (71lbs) excluding removable attachments and hoses.							
Dimensions	35 x 64 x 93 cm (13.9 x 25.3 x 36.6 in)							
Max Air Off	100°C (212°F)							
Operating Range	-20°C to 50°C (-4°F to 122°F)							
Construction	Rotomoulded double skinned housing							
Safety	CE	CE	RCM	UL	UL	CE	UL	UL



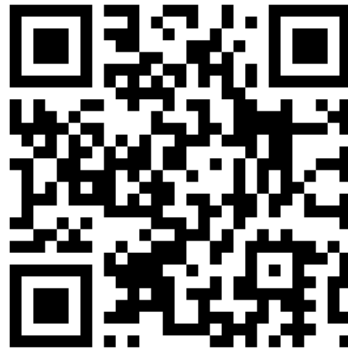

An electronic version of this instruction manual is also available online via this QR code or by visiting:  
*<http://www.drymatic.com/>*

## INSTRUCTION MANUAL

**Models:** FGPH061; FGPH062; FGPH063; FGPH064; FGPH065; FGPH066; FGPH070; FGPH071

**DBK Technitherm Limited**

Unit 11, Llantrisant Business Park, Llantrisant, CF72 8LF, Wales, United Kingdom

Tel: +44 (0) 1443-23-79-27 Fax: +44 (0) 1443-23-78-67

Patented in Australia (AU2009272484), United States (US8720080 & US9015960), Great Britain (GB2462066 & GB2488873) and patents pending in Europe (EP2307838 & EP2498036).

All worldwide design rights and copyright reserved.



Contact DBK Technitherm for approvals information as required.

Manufactured by DBK Technitherm LTD.

LA0362 Issue 01