



NT240 TIMER

PROGRAMMABLE TIMER – INSTRUCTIONS MANUAL V20x I

INTRODUCTION

The NT240 is a programmable timer designed to monitor time intervals, activating its outputs according to some predefined mode of operation and time intervals chosen by the user. The user can also create its own mode of operation to best fit his application.

The timer shows the elapsed time in an increasing or decreasing mode, with resolutions from 0.01 s to 1 hour.

Digital inputs are available to perform specific functions. Standard outputs are relay and logic pulse (5 V) types.

SPECIFICATIONS

DIMENSIONS:..... 48 x 48 x 110 mm (1/16 DIN).

.....Approximate weight : 150 g

CUT FOR PANEL FIXATION:.....45.5 x 45.5 mm (+0.5 -0.0 mm)

POWER: 100 to 240 Vac/dc ($\pm 10\%$), 50/60 Hz

Optional 24 V: 12 to 24 Vdc / 24 Vac (-10 % / 20 %)

Maximum consumption:..... 3 VA

ENVIRONMENTAL CONDITIONS:

Operation temperature: 5 to 50 °C

Relative humidity: Relative humidity maximum: 80 % up to 30 °C.

For temperatures above 30 °C, decrease 3 % per °C.

Internal use; Installation category II, Pollution degree 2; Altitude < 2000 m

INPUTS (Digital Inputs): Sensors type NPN/PNP

..... Dry contact NA/NF

Voltage pulse: Logic level 1: 5 to 30 Vdc / Logic level 0: -0.5 to +0.5 Vdc

OUTPUT (Timer Output):..... 1 Relay SPST-NA – 3 A / 250 Vac

..... 1 voltage pulse 5 V / 25 mA

Time delay after turning on the timer:200 ms

Accuracy:0.5 % of displayed time

Response time: 10 ms for the relay output

.....0.3 ms for the pulse output

Auxiliary voltage source: 12 Vdc $\pm 10\%$ / 50 mA

ELECTROMAGNETIC COMPATIBILITY: EN 61326-1:1997 and EN 61326-1/A1:1998

SAFETY: EN61010-1:1993 and EN61010-1/A2:1995

SPECIFIC CONNECTIONS FOR TYPE FORK TERMINALS OF 6.3 MM;

FRONT PANEL: IP65, POLYCARBONATE UL94 V-2; **CASE:** IP30, ABS+PC UL94 V-0;

PROGRAMMABLE PWM CYCLE FROM 0.5 SECONDS AND 100 SECONDS;

STARTS UP OPERATION AFTER 3 SECONDS CONNECTED TO THE POWER SUPPLY.

TIMER INPUTS

The timer has three control inputs: **START**, **HOLD** and **RESET**.

These inputs can be configured to accept four different electrical (logical) signals (see parameter *PnP* in the configuration). The signal type there defined becomes the same for all three inputs.

START: Starts time counting

The start input, when activated, starts the temporization cycle, using the operating mode selected in the configuration. The START input is available on terminals 9 and 12.

HOLD: Interrupts time counting

The HOLD input, while active, interrupts time counting. When the HOLD input is released, the time counting resumes from the point it was interrupted.

NOTE: The HOLD function can be activated by the **[F]** key, when programmed to perform as such on the **F F_u** parameter of the timer. Using the **[F]** key as the input to HOLD function, pressing once **stops** the timer and pressing again **resumes** the counting of time.

RESET: Timer Input Reset

The Reset input, when activated, cancels the current temporization and returns the timer display to the initial value. While Reset is active, the temporization can not be started. When Reset is released, the timer becomes available for new temporization.

TIMER OUTPUTS

The timer provides an output, called **TIMER OUTPUT**, which can be activated in various ways according to the selected temporization mode. This output is available as a relay contact and as a voltage pulse (both operate simultaneously).

Output types: 1 SPST – 3 A / 250 Vac relay, terminal 3 and 4;

1 voltage pulse of 5 V / 25 mA, terminals 5 and 6

Output delay time: 10 ms for relay output;

0.3 ms for pulse output.

The **OPER** parameter defines the way the output will operate.

AUXILIARY SUPPLY OUTPUT

A 12 Vdc $\pm 10\%$ (50 mA max) auxiliary power supply is provided on terminals 7 and 8 to power electronic sensors used as inputs to the timer. The (-) supply terminal is wired internally to the GND terminal of the inputs (**the supply is not electrically isolated from the inputs**).

INSTALLATION

Panel Mounting

Insert the unit into the panel cut-out (use the dimensions specified in the "Technical Specifications" section) and slide the mounting clamp from the rear to a firm grip at the panel.

The timer circuitry can be removed from its case from the front, without the need of disassembling the instrument from the panel, leaving the wire connections intact.

Recommendations for Installation

Input signal wires should be laid out away from power lines and preferably inside grounded conduits.

Instrument mains should be suitable for this purpose and wires should not be shared with high consumption motors and inductors.

Use of RC filters (47 Ω and 100 nF) in parallel with solenoids and contactor coils are highly recommended.

In monitoring and control applications it is essential to consider what can happen when any part of the system is subject to failure.

Electric connections

Figure 01 shows the timer terminals along with their functions.

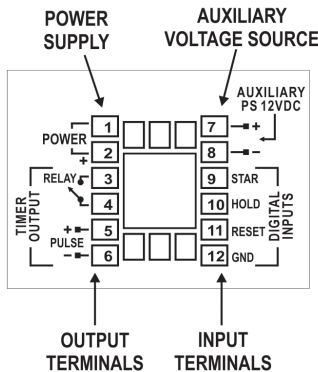

Figure 01 – Timer connections panel

Connections of the input signals

The type of signal to be applied to the inputs is determined by the user in the **PnP** parameter of the timer. The signal type must be the same for the three inputs (Start, Hold and Reset).

Sensors with NPN/PNP open collector output

Common to most proximity sensors, must be connected as indicated in Figure 02. The **PnP** parameter must be set to 0 for NPN sensor output and to 1 for PNP.

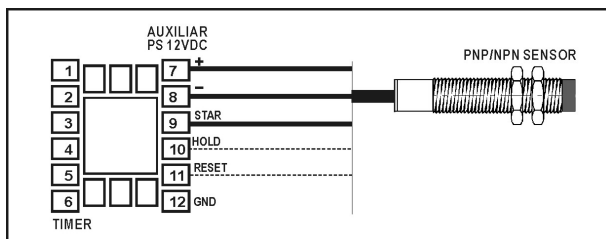

Figure 02 – Connecting PNP/NPN type sensor

Voltage input signal

Refer to the “Specifications” section for the input voltage levels compatible with the timer. Figure 03 shows the wiring scheme.

When **PnP** = 1, the timer recognizes the rising edge of the pulse. For the recognition of the falling edge, set **PnP** = 0.

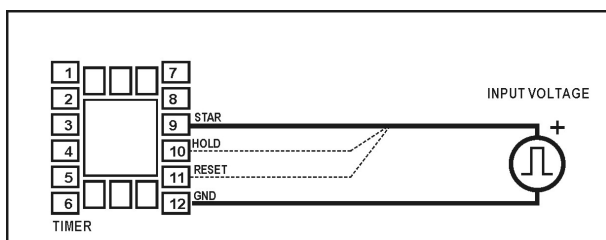

Figure 03 – Connection for pulse input.

Signal from relay or switch (dry contact):

Wire dry contacts as shown on Figure 04. For this type of input, configure **PnP** = 0.

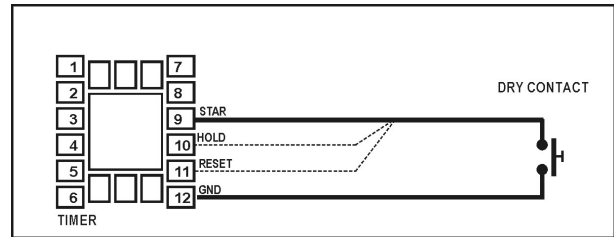

Figure 04 – Connecting dry contact (relay, switch key)

OPERATION

Following power-on, the timer shows the main screen (Time) and will remain in this screen in normal operation.

For configuring the timer, it is necessary to set proper values to the various internal parameters.

The parameters are organized in three cycles. To enter these cycles, one must press the [P] key for defined intervals of time, as shown below.

Cycles structure:

- 1 Indication of elapsed time
Shown on power-up;
- 2 Setpoint cycle (temporization setpoints)
To enter, press [P] for 4 seconds;
- 3 Configuration cycle.
Press [P] for 8 seconds;
- 4 Custom Operating mode cycle.
Press [P] for 12 seconds;

To enter into deeper cycles, press the [P] for the time required by the cycle and when the timer shows the first parameter of that cycle, simply release the [P] key to stay in that cycle. Other parameters in that cycle are accessed by pressing the [P] key.

To modify the value of a parameter use the [▲] and [▼] keys for incrementing or decrementing the value, respectively. After the last parameter of the cycle is reached, the timer returns the main screen (Indication of Elapsed time).

The modified values are stored in a non-volatile memory when the [P] key is pressed to move to the next parameter.

PROGRAM SECURITY

To avoid tampering, parameter “**Prot**” and a hardware jumper can be used to disable access to programming parameters.

With the jumper in the **OFF** position, all program levels are unprotected. The “**Prot**” parameter can only be changed with the jumper in the **OFF** position.

With the jumper in the **ON** position or **removed**, the protection level is defined by the current value of the “**Prot**” parameter:

- 0 No protection. All parameters can be accessed;
- 1 No access to Operating mode cycle.
- 2 No access to Operating mode cycle and Configuration cycle.
- 3 Full protection.

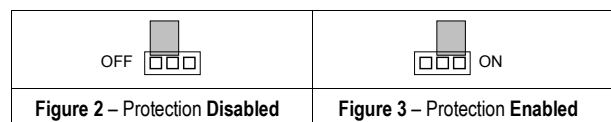

Figure 2 – Protection Disabled

Figure 3 – Protection Enabled

Temporization Setpoints Cycle

t ISP Timer 1 SetPoint	Timer Setpoint: It defines the total time to be counted by the timer. In up counting, the timer counts from zero to the value programmed in t ISP . In countdown, the timer counts from the value programmed in t ISP to zero.
Out Output 1 Time	Output temporization: Defines the interval of time the output is to remain active after the time programmed in t ISP has elapsed (parameter t IS4 shall be set to 1 ⇒ output turns off after output temporization). During the output temporization the relays are maintained active while the corresponding LEDs blink to indicate the output temporization is taking place.

Configuration Cycle

OPER Operation Mode	The timer has 11 pre-defined operating modes (0 to 10) plus the possibility for the user to create his own customized mode. The operation modes are described with further details in the section "Timer Operation Modes". There is an option that allows the elaboration of a custom mode of operation. <ul style="list-style-type: none"> 0 Delayed output following power on 1 Delayed pulse after power on 2 Pulse on power on 3 Cyclic after power on 4 Pulse after momentary input signal 5 Extended pulse after release of the input signal 6 Delayed output after momentary signal in the input 7 Delayed pulse after momentary signal in the input 8 Pulse after continuous signal in the input 9 Delayed output following continuous input signal 10 Delayed pulse after continuous input signal 11 Special mode defined by the user
IR	Temporization ranges: sets the interval range to be used by the timer, as below: <ul style="list-style-type: none"> 0: 99.99 s 4: 9999 min 1: 999.9 s 5: 99 h 59 min 2: 9999 s 6: 9999 h 3: 99 min 59 s
t WUP	Defines the count mode presentation to the display: <ul style="list-style-type: none"> 0: down counting 1: up counting
F FU	Function of the front panel [F] key: <ul style="list-style-type: none"> 0: The [F] key is not used; 1: Reset – Resets time counting; 2: Reset and Hold – Restarts or pauses time counting. The key function depends on operation mode chosen for the timer, as described in the section "Timer Operation Modes".
PnP	Defines the type of the signal to be applied to the timer input. <ul style="list-style-type: none"> 0: Sensor with open collector NPN output or dry contact; Sensor with open collector PNP output or logical DC pulse

ou Ir	Output temporization range, to be used by the Out parameter. <ul style="list-style-type: none"> 0: 99.99 s 4: 9999 min 1: 999.9 s 5: 99 h 59 min 2: 9999 s 6: 9999 h 3: 99 min 59 s
Prot	PROTECTION OF PARAMETERS : Defines the level of protection for the parameters. Configure this parameter prior to removing the protection jumper. See manual item Program Security .

Custom Operating Mode Cycle

The parameters in the Custom Operating Mode level are automatically set by the timer when a predefined operating mode is selected (**OPER** = **0** to **10**). The parameters below are used when the user needs to customized the timer to a particular mode of operation (**OPER** = **11**).

t IS1	Temporization Start. This parameter defines when the temporization should be initiated: <ul style="list-style-type: none"> 0: On timer power-up. 1: Upon Start input activation (leading edge of the Start input). 2: Upon Start input being released (trailing edge of the Start input) 3: Start input leading edge only when the output is off 4: Start input trailing edge only when the output is off 5: Through the [F] key. The Function programmed for the [F] key must be Reset and Hold (FFu = 2).
t IS2	Defines the timer action when the start input is activated during the temporization: <ul style="list-style-type: none"> 0: Restarts temporization 1: Disregard the Start input when the temporization is in progress 2: Interrupts temporization.
t IS3	This parameter defines the moment the output is to be activated: <ul style="list-style-type: none"> 0: At the leading edge of the Start input signal. 1: At the trailing edge of the Start input signal. 2: At the beginning of the temporization. 3: At the end of the temporization.
t IS4	This parameter defines how the output is to be turned off: <ul style="list-style-type: none"> 0: At the end of the programmed time interval; 1: After the output temporization, as defined in Out; 2: Only by the Reset command. <p>The Reset can be accomplished either by the Reset input or by the [F] key programmed with Reset function (FFu = 1).</p>
t IS5	Automatic temporization restart. Allows cyclical temporization, according to the values below: <ul style="list-style-type: none"> 0: No automatic restart. 1: Restart at the end of the temporization (as defined in t ISP). 2: Restart after the end of the output temporization (t ISP + Out.1)

PARAMETER CHANGE WHILE TEMPORIZATION IS IN PROGRESS

When a parameter in the programming cycles of the timer is modified by the user, the temporization in progress is interrupted and the timer reset.

Do not change timer configuration while the temporization is performing critical functions, as the outputs may be turned on and off at improper moments.

TIMER OPERATING MODES

The timer offers 11 predefined operating modes plus the possibility for the user to customize his own mode of operation, by configuring parameters t 151 to t 155. Modes 0 to 10 are the predefined ones, whereas mode 11 left to the user control. They are described below:

Mode 0 – Delayed activation after power-up

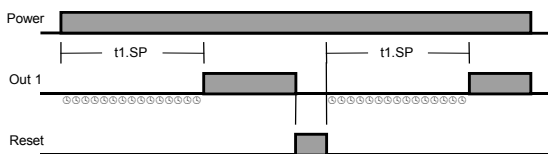

t 151 to t 155 are automatically set to:

t 151	t 152	t 153	t 154	t 155
0	0	3	2	0

- The key can be programmed either as Reset or Reset/Hold.

Mode 1 – Delayed pulse after power-up

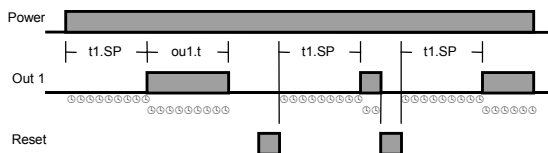

t 151 to t 155 are automatically set to:

t 151	t 152	t 153	t 154	t 155
0	0	3	1	0

- The key can be programmed either as Reset or Reset/Hold.

Mode 2 – Pulse at power-up

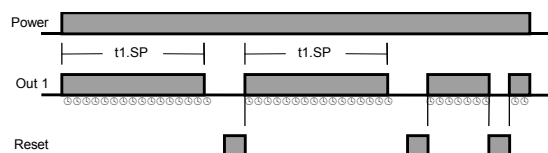

t 151 to t 155 are automatically set to:

t 151	t 152	t 153	t 154	t 155
0	0	2	0	0

- The key can be programmed either as Reset or Reset/Hold.

Mode 3 – Cyclic after power-up

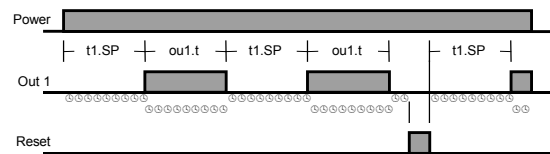

t 151 to t 155 are automatically set to:

t 151	t 152	t 153	t 154	t 155
0	0	3	1	2

- The key can be programmed either as Reset or Hold.

Mode 4 – Pulse after momentary Start signal

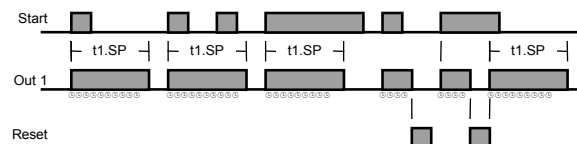

t 151 to t 155 are automatically set to:

t 151	t 152	t 153	t 154	t 155
1	1	2	0	0

- The key can be programmed as Reset/Hold.

Mode 5 – Extended pulse after output is turned off

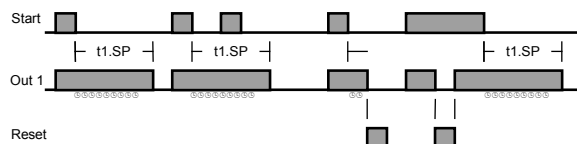

t 151 to t 155 are automatically set to:

t 151	t 152	t 153	t 154	t 155
2	1	0	0	1

- The key can be programmed as Reset/Hold.

Mode 6 – Delayed output after momentary START signal

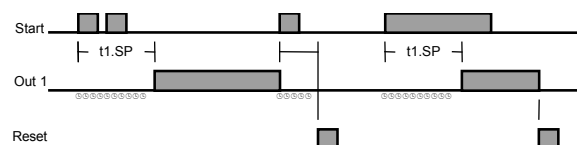

t 151 to t 155 are automatically set to:

t 151	t 152	t 153	t 154	t 155
1	1	3	2	0

- The key can be programmed as Reset/Hold.

Mode 7 – Delayed pulse after momentary START signal

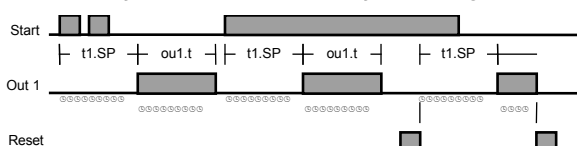

t 151 to t 155 are automatically set to:

t 151	t 152	t 153	t 154	t 155
3	1	3	1	0

- The key can be programmed as Reset/Hold.

Mode 8 – Pulse after a continuous START signal

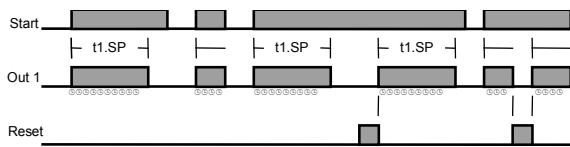

t 151 to t 155 are automatically set to:

t 151	t 152	t 153	t 154	t 155
1	2	2	0	0

- The **[F]** key can only be used for holding the temporization in progress.

Mode 9 – Delayed output after a continuous START signal

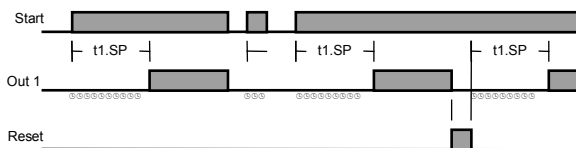

t 151 to t 155 are automatically set to:

t 151	t 152	t 153	t 154	t 155
1	2	3	2	0

- The **[F]** key can only be used for holding the temporization in progress.

Mode 10 – Delayed pulse after continuous START signal

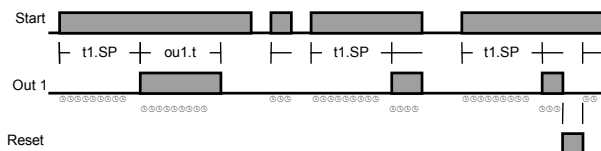

t 151 to t 155 are automatically set to:

t 151	t 152	t 153	t 154	t 155
1	2	3	1	0

- The **[F]** key can only be used for holding the temporization in progress.

Mode 11 – Customized Mode of Operation

In this mode, the operator is allowed to create his own mode of operation if the predefined ones don't meet the process needs. This can be accomplished through parameters t 151 to t 155 in the Custom Operating Mode cycle of parameters. The user must analyze each one of the 5 parameters and understand the effect that each one has on the timer. The user must consider that not all the combinations of the parameters t 151 to t 155 are valid, and that some combinations may lead to unexpected behaviors.

When programming a customized operation mode, the user must test it to verify that it suits the application before incorporating it to the system.

IDENTIFICATION

In order to identify your model of NT240, check the name in the device label:

Example:

	NT240 - A	RP - B	24V C
A: Model	NT240		
B: Optional	RP (version with OUT1: Pulse and Relay)		
C: Power Supply	Blank (basic version, with power supply 100 to 240 Vac/dc) 24V (version with power supply 12 to 24 Vdc / 24 Vac)		

WARRANTY

Warranty conditions are available on our website www.novusautomation.com/warranty.