





N1500FT Digital Panel Meter

DIGITAL PANEL METER – INSTRUCTIONS MANUAL – V1.2x I

SAFETY ALERTS

The symbols below are used on the equipment and throughout this document to draw the user's attention to important operational and safety information.

	
CAUTION: Read this manual carefully prior to installation and operation of the unit.	CAUTION OR DANGER: Electric shock hazard

All safety related instructions that appear in the manual must be observed to ensure personal safety and to prevent damage to either the instrument or the system. If the device is used in a manner not specified in this manual, its safety features may be impaired.

INTRODUCTION

This flow rate digital panel meter provides indication, totalization, retransmission, alarm, and RS485 communication features (optional RTU Modbus slave). It reads most flow signals available in the market, such as pulse, magnetic pickup and 4-20 mA.

The pulse input allows connecting sensors with outputs such as reed-switch, NPN, PNP and tension. Both for pulse input and 4-20 mA input, unit is selectable, and a scale factor is set to turn the input signal into the unit of choice. It provides an isolated pulse output for totalized flow retransmission and a 4-20 mA output for immediate flow retransmission. Alarms are set off through 2 to 4 relays, depending on the equipment model.

AC models provide a 24 Vdc / 50 mA output.

INPUTS

The flow rate digital panel meter allows for two basic input types:

- Instantaneous flow input through a 4-20 mA signal. In this case, flow totalization is obtained by integrating instantaneous flow rate.
- Totalized flow input through a pulse signal. In this case, instantaneous flow rate is obtained by deriving totalized flow rate.

Pulse signals may come from sensors/transmitters with NPN, PNP, dry contact (reed switch) and tension signal output, or even magnetic pickup outputs.

When the input is set to 4-20 mA, you should establish on screens **InLL** and **InHL** which flow values are equivalent to 4-20 mA.

When the 4-20 mA input is not used as flow input, it may be used alternatively as auxiliary input. This way it is possible to measure the pressure of a pipeline, for instance.

The pulse flow input may be scaled, both for instantaneous and totalized flow rates (independently), through 'K' multiplication factors: **P.InSt** and **P.tot**.

Both flow time base and unit must be defined on screen **UnIt I**. To do so, there are six characters, the first five of which are used to set the unit and the last one (to the right) is used to set the time base on which the flow rate is measured. Available time bases are 's' (seconds), 'm' (minutes), 'h' (hours) and 'd' (days).

With pulse flow input, totalization will continue even if the input rate is below the minimum rate required. Instantaneous flow rate indication will be zero whenever there is a time lapse of 10 seconds without input variation. In this case, whenever there is a totalization increase (more input pulses), the instantaneous flow value will be shown for the next 10 seconds.

"K" FACTORS

The instantaneous K factor (**P.InSt**) and the total K factor (**P.tot**) allow the user to view the instantaneous and totalized flow in different units.

The instantaneous K factor will be available only in case the selected flow input type is different from 4-20 mA. When the input type is 4-20 mA, the configured range limits already provide the parameters for the indication.

Instantaneous flow is related to the time base set in parameter **UnIt I**.

In case user erroneously configures parameters **P.InSt** and **P.tot** with value "0" (zero), this will be assigned value "0.00001".

EXAMPLE 1:

Chosen meter gives us an information of (pulses per volume) 50 pulses per liter. User wants to view the instantaneous flow in liters (l) and the totalized flow in cubic meters (m³).

To do that, parameter **P.InSt** should be set a value of "50", so indicating the instantaneous flow in liters. Parameter **P.tot** should be set a value of "50000", so indicating the totalized flow in m³.

Instantaneous flow will be viewed based on the selected time base in **UnIt I**. In case the example meter output is 50 pulses per second, which means 1 liter/second, and the selected time base is m (minute), the instantaneous flow indication will be 60 (liters/minute).

EXAMPLE 2:

Chosen sensor gives us an information in 4-20 mA that corresponds to a flow between 0 and 100 liters per minute. User wants to view the totalized flow in cubic meters (m³).

On this case, parameter **InTYPE** should be selected as 4-20 mA and parameters **InLL** and **InHL** should be configured as "0" and "100". This way, we pass to the equipment the information that 4 mA relates to 0 liters per minute and 20 mA relates to 100 liters per minute. In case sensor output is 12 mA, flow will be displayed as 50 liters/minute.

Parameter **P.tot** should have a value of 0.001 (1 liter = 0.001 m³). This way, the totalized flow will be converted and displayed in m³ (cubic meters).

When the instantaneous flow type is selected as 4-20 mA, the time base selected in **UnIt I** have no influence over the indicated values, having just unit display purposes. The indication conversion from "liters per minute" to "liters per hour" should be adjusted directly on input limits **InLL** and **InHL**.

In case user wanted instantaneous flow indicated in cubic meters per hour (m³/h) with the same meter, the values "0" and "6" should have been selected in input limits **InLL** and **InHL**, where the second value means 100 l/min converted to m³/h. **P.tot** parameter should be changed to "1" because input is already in m³.

CUSTOMIZED LINEARIZATION

When the flow rate is read through a 4-20 mA input, it is possible to apply a customized linearization composed of 30 input points and 30 output points. Whenever the reading falls between two input points, it will be normalized to the range defined by the respective points in the output range.

The input range considered as an input to the linearization table is the range defined by the user in the **InLL** and **InHL** parameters (it is not the current in mA). In case user wants to enter the values directly in mA to convert to the desired viewing unit, parameter **InLL** must be set as 4 (mA) and parameter **InHL** as 20 (mA), using as many decimal places as needed to the desired precision. It will be possible then to enter values between 4-20 (mA) as input points for the customized linearization.

The search for framing the value read is done while the list of input points is incrementally declared. The search is terminated if the next point in the list is lower than the current one. If the input value is lower than the first value in the list of input points, linearization will return the first output value. Similarly, if the input value is greater than the highest value in the list of input points, linearization will return the highest value in the output list.

IMPORTANT: At least two pairs of input-output points are required for adequate customized linearization.

RETRANSMISSION

Flow rate retransmission can be done via 4-20 mA output and pulse output.

The 4-20 mA output may be used regardless of the type of flow input. To use it, just set the retransmission range to **rELL** and **rEHL**, associating the flow rates to 4-20 mA.

In the case of retransmission via pulse output, one must choose between volumetric pulse output and frequency pulse output. The former may be used regardless of the type of input, while the latter is available only for pulse inputs.

In the volumetric mode, a pulse of configurable length is generated every time the totalizer accumulates a preset volume. For example, for a period of 1 second and volume of 10 liters, a 1-second pulse will be generated for every 10 liters totalized. The counting to the output pulse will be reset every time the user resets the totalizer or whenever a feeding process is finished.

Note: In case the feeding process is running, and the totalizer is reset by the user, the process will remain running normally, but the output pulse will not be synchronized with this process anymore, which can lead to a missing pulse informed at the end of the feeding process. As it is always reset at the end of the process, output pulse counter will synchronize again for a new feeding process.

In the frequency mode, the pulse output will divide the input frequency by a programmable constant whose value is equal to or higher than 2.

IMPORTANT: Maximum output frequency has hardware limitation. See Specifications. Check the [SPECIFICATIONS](#).

ALARMS

The digital panel meter basic version has 2 alarm outputs, with the option of up to 4 alarms. Whenever an alarm is on, a corresponding **light signal** will be displayed on the front panel.

ALARM FUNCTIONS

The alarms can be programmed to operate with four functions, described below. They may also be turned **OFF**.

Alarms use only the instantaneous flow rate reading. Totalization readings cannot be used as input for alarms. The auxiliary 4-20 mA input (when it is not being used for flow rate measurement) may be used only as input for the open sensor alarm.

- Open Sensor – **Error**

The open sensor alarm operates whenever the input sensor is badly connected or broken. Valid only for 4-20 mA inputs.

- Minimum Value – **Lo**

It sets off when the reading is below the value determined by the alarm Setpoint.

- Maximum Value – **Hi**

It sets off when the reading is above the value determined by the alarm Setpoint.

- Feeder Function – **FEEDer**

It activates the output relay when it is started by pressing **F** or via the auxiliary digital input (according to setup) and deactivates when the reading reaches the value determined by the alarm setpoint or when the **F** key or digital input is pressed/closed again, putting the process on hold. In case of pressing the **F** key or digital input more than 3 seconds, process is reset and stays waiting to be started.

Further details in the [FEEDER](#) section.

ALARM TIMER

The digital panel meter allows setting up an **Alarm Timer**, where users can set the alarm to go off with a delay, to go off in only one pulse or to go off in sequential pulses.

Figures in **Table 1** show these functions. There, times T1 and T2 may vary from 0 to 32000 seconds and are defined while programming the digital panel meter. For regular (no timers) operation of alarms, simply set T1 and T2 to 0 (zero).

The alarm light signals will be displayed whenever there is alarm condition, regardless of the status of the output relay, which may be temporarily out of power because of the timer function.



ADVANCED FUNCTION	T1	T2	ACTION
Regular Operation	0	0	Alarm Output 
Delay	0	1 to 32000	Alarm Output 
Pulse	1 to 32000	0	Alarm Output 
Oscillator	1 to 32000	1 to 32000	Alarm Output 

Table 1 – Alarm timer functions

ALARM HYSTERESIS

Hysteresis defines the difference between the value measured when the alarm is triggered and the value at which it is deactivated.

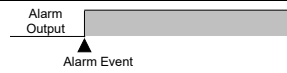
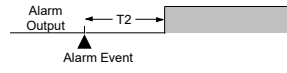
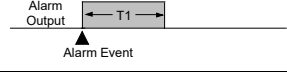
INITIAL ALARM BLOCK

The **Initial Block** option prevents the alarm from going off in case there is alarm condition at the time the digital panel meter is being energized. The alarm may be triggered only after a non-alarm condition is followed by an alarm condition.

This function is not valid for alarms programmed as Open Sensor.

SPECIAL FUNCTIONS

MAXIMUM AND MINIMUM

The digital panel meter continuously records the minimum and maximum values of instantaneous flow rate. These values can be viewed on the first screen of the main cycle by pushing **MAX** and **MIN**, respectively. The **F** key can be set to zero maximum and minimum values.

AUXILIARY DIGITAL INPUT AND KEY

Like the digital input, the  key can be set to zero the totalizer, freeze the main screen, zero minimum and maximum readings or control the feeder function.





FEEDER

The feeder function is used to control the volume of fluids based on its flow rate. It is typically used for storage applications, where there is a start signal that triggers a relay, and the flow rate begins to be measured. When reaching a given setpoint, this relay is deactivated to stop flow.

Its use depends on correct configuration of the related alarm.

During the feeder process, it is not possible to change the alarm setpoint. Process should be reset first to allow it.

Functions of  key and/or digital input, when assigned to the feeder function:

- When the  key or digital input is activated, the feeder process is started, activating all relays related to the feeder alarm.
- In case the  key or digital input is activated once again, the process is frozen and all relays related to the feeder alarm are deactivated.
- To restart the feeder process,  key or digital input must be activated for 3 seconds, until the process is restarted, zeroing all existing feeder indication. This can be done with the process stopped or running.
- At the end of the feeder process, when alarm setpoint is reached, process values are frozen and all related relays are deactivated. To restart a new process, just activate the  key or digital input for all counters to be reset and process will start running.
- In case of a power shortage, if the feeder batch reset parameter (**baRtRSt**) is configured as **no**, whenever the equipment powers up again the process will restore from where it stopped. This means that, if it was in the middle of a feeder process, all relays assigned to the feeder alarm will be activated. If the process was stopped, all counters will keep their values and the process will remain stopped until it is activated either by the  key or the digital input.

MANUAL OPERATION MODE

In the hardware cycle, outputs can be set manually. This can be extremely useful for tests and simulations. After exiting the cycle, outputs go back to their regular status.

24 VDC AUXILIARY POWER SUPPLY

DC power supply models provide a 24 Vdc output for field transmitters.

INSTALLATION

The digital panel meter must be installed on a panel. To do so, remove the two plastic clamps, introduce the device in the panel cutout and put the clamps back from the rear side of the digital panel meter.

INSTALLATION RECOMMENDATIONS

- Input signal conductors should be disposed in the system separately from output conductors and power conductors, preferably in grounded electrodes.
- Instruments should be powered through a dedicated network.
- For control and monitoring applications it is vital to consider what might happen if any part of the system fails. The alarm internal relay does not ensure total protection.
- It is recommended to use RC FILTERS (47 Ω and 100 nF, series) in contactor coils, solenoid coils, etc.

ELECTRICAL CONNECTIONS

The inside can be removed without the need to undo the electrical connections. Disposition of signals in the rear panel is shown in **Figure 1**:

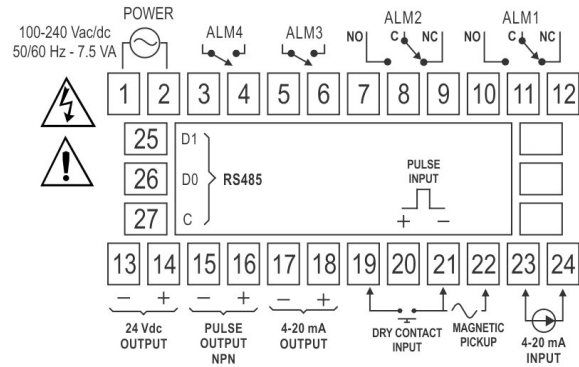

Figure 1 – Rear panel connections

POWER SUPPLY CONNECTION

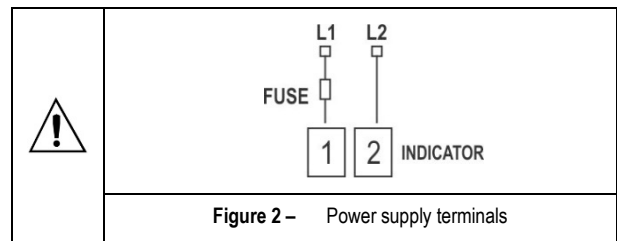
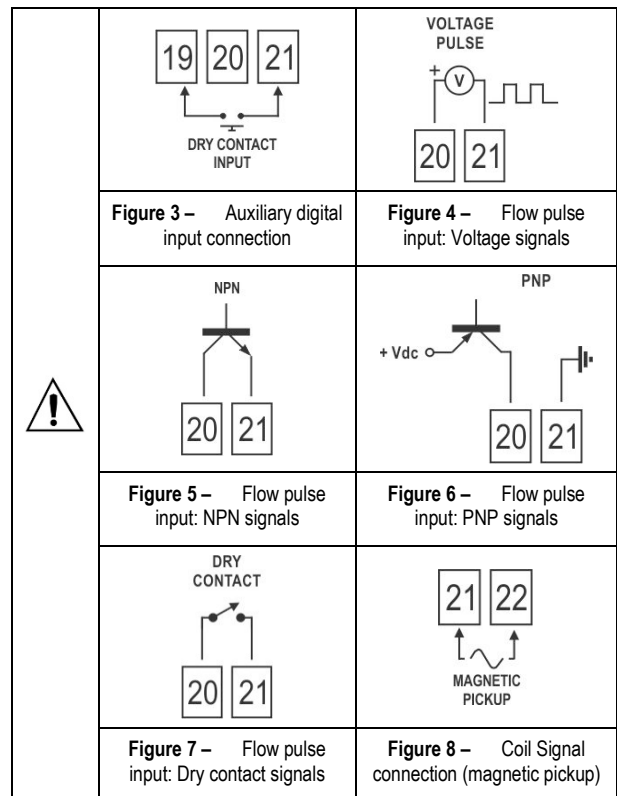

Figure 2 – Power supply terminals

CONNECTIONS FOR INPUT AND OUTPUT SIGNALS

It is important that these connections are well made, with signal or sensor wires securely attached to rear panel terminals. Check the [SPECIFICATIONS](#) section for the range of the input signals.

The images below show connections for different input types:



The images below show connections for different output types:

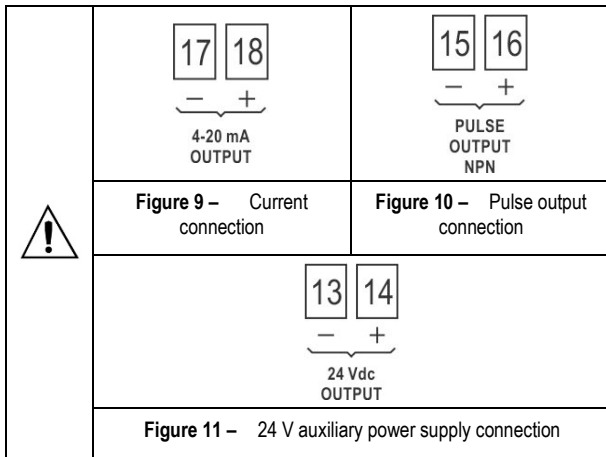

OPERATION

The front panel can be viewed in **Figure 12**:

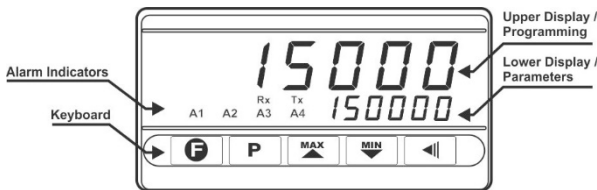

Figure 12 – Identification of front panel parts

The digital panel meter has the following parts:

Upper Display / Programming: Shows the intended value (set on *SP.A1* screen of Function Cycle). At the time of setup, it shows the mnemonics for the different parameters that should be defined.

Lower Display / Parameters: Shows the intended value (set on *SP.A1* screen of Function Cycle). At the time of setup, it shows the values established for the several parameters.

Rx and Tx Indicators: They show activity in the RS485 communication line.

A1, A2, A3 and A4 Indicators: They show the alarms that are on.

F Key: "Function" key, whose operation is user selectable.

P Key: This key has two functions. When you press it quickly, you are taken to the next screen. When you press and hold for more than 3 seconds, you will be taken to the next cycle and subsequently on if you keep holding.

Up MAX and Down MIN keys: They allow changing the parameter values. They are also used for viewing the memorized maximum and minimum values.

Return Key: Return key. When you press it quickly, you are taken to the previous screen. If you press and hold for more than 3 seconds outside the main cycle, you will be taken back to the main cycle. If you hold this key for more than 10 seconds inside the main cycle, the 8-digit serial number will be shown on both displays.

FUNCTION	OPERATION METHOD
Go to the next cycle.	Press P for more than 3 seconds.
Go to next screen in the cycle.	Press P .
Go to previous screen in the cycle.	Press Return .
Increase the number of decimal places in the value viewed.	Press Return while holding MAX . Available only for some parameters!
Reduce the number of decimal places in the value viewed.	Press Return while holding MIN . Available only for some parameters!

FUNCTION	OPERATION METHOD
Change a digit in the value being modified.	Press Return while holding P . Available only for some parameters!
Change a parameter.	Press MAX or MIN to select the next option or, in the case of a numerical value, to increase or decrease the value.
Show the maximum value.	On the first screen of the main cycle, press MAX .
Show the minimum value.	On the first screen of the main cycle, press MIN .
Show the equipment serial number.	On the first screen of the main cycle, press Return for 10 seconds.

SPECIAL KEYBOARD FUNCTIONS (DECIMAL PLACES)

There are several screens whose values are the "floating point" type, that is, they take a varying number of decimal places. In such cases, special combinations of keys may be used to edit values.

The special function is activated by pressing **Return**. Therefore, you have 3 seconds to use it with any other key.

To increase the number of decimal places, quickly press **MAX** while holding **Return**. The number of decimal places will be reduced if you quickly press **MIN** while holding **Return**.

When the operating element of the screen is the floating-point type, it is also possible to choose which digit will be increased or decreased.

To choose the digit, quickly press **P** while holding **Return**. Selection of the digit occurs from right to left and the chosen digit will blink fast.

There is an exception to the main screen. Instead of parameters, this screen shows values for the inputs. These values are shown as floating points in both displays. In this case, it is possible to set the number of decimal places in the lower display by quickly pressing **MIN** while holding **Return**.

To set the number of decimal places in the upper display, quickly press **MAX** while holding **Return**.

Note: It is recommended to disable/suspend the control whenever it is necessary to change the device settings.

PROGRAMMING THE DIGITAL PANEL METER

MAIN CYCLE

BBBBBB BBBBBB	The first screen of the main cycle can be programmed in the <i>SP.A1</i> screen.
SP.A1 <i>Setpoint Alarm 1</i>	Setpoint Alarm 1. Visible only if alarm 1 is active.
SP.A2 <i>Setpoint Alarm 2</i>	Setpoint Alarm 2. Visible only if alarm 2 is active.
SP.A3 <i>Setpoint Alarm 3</i>	Setpoint Alarm 3. Visible only if alarm 3 is active.
SP.A4 <i>Setpoint Alarm 4</i>	Setpoint Alarm 4. Visible only if alarm 4 is active.

ALARM CYCLE

FuR1 <i>Function Alarm 1</i>	Selection of Alarm 1 function: oFF , lError , Lo , Hl and FEEdEr .	
HYR1 <i>Hysteresis Alarm 1</i>	Hysteresis Alarm 1.	Visible only if FuR1 is different from oFF , from lError and FEEdEr .
bLR1 <i>Block Alarm 1</i>	Block Alarm 1.	
AlE1 <i>Alarm 1 Timer 1</i>	Alarm 1 Timer 1 (in seconds).	Visible only if FuR1 is different from oFF and FEEdEr .
AlE2 <i>Alarm 1 Timer 2</i>	Alarm 1 Timer 2 (in seconds).	
FuR2 <i>Function Alarm 2</i>	Selection of Alarm 2 function: oFF , lError , Lo , Hl e FEEdEr .	
HYR2 <i>Hysteresis Alarm 2</i>	Like Alarm 1.	Visible only if FuR2 is different from oFF , from lError and FEEdEr .
bLR2 <i>Block Alarm 2</i>		
AlE1 <i>Alarm 2 Timer 1</i>		Visible only if FuR2 is different from oFF and FEEdEr .
AlE2 <i>Alarm 2 Timer 2</i>		
FuR3 <i>Function Alarm 3</i>	Selection of Function Alarm 3: oFF , lError , Lo , Hl and FEEdEr . Visible only for the 4 relays model.	
HYR3 <i>Hysteresis Alarm 3</i>	Like Alarm 1	Visible only if FuR3 is different from oFF , from lError and FEEdEr .
bLR3 <i>Block Alarm 3</i>		
AlE1 <i>Alarm 3 Timer 1</i>		Visible only if FuR3 is different from oFF and FEEdEr .
AlE2 <i>Alarm 3 Timer 2</i>		
FuR4 <i>Function Alarm 4</i>	Selection of Function Alarm 4: oFF , lError , Lo , Hl and FEEdEr . Visible only for the 4 relays model.	
HYR4 <i>Hysteresis Alarm 4</i>	Like Alarm 1.	Visible only if FuR4 is different from oFF , from lError and FEEdEr .
bLR4 <i>Block Alarm 4</i>		
AlE1 <i>Alarm 4 Timer 1</i>		Visible only if FuR4 is different from oFF and FEEdEr .
AlE2 <i>Alarm 4 Timer 2</i>		

FUNCTION CYCLE

MAIn <i>Main screen Prog</i>	Setup of first screen of the main cycle.
KEY F <i>Key Function</i>	Selection of  key function.
dIn F <i>Digital Input Function</i>	Selection of digital input function.

rESEt <i>Reset</i>	Resets totalizer.
bARSEt <i>Feeder Batch Reset</i>	When the no option is selected: In case of a power loss, feeder process states and variables will not be lost and, whenever power is back, it will resume feeding automatically, just as it was before the power loss. When the YES option is selected: In case of a power loss, feeder process states and variables will be reset and, whenever power is back, it will remain waiting for a new process start.
bAud <i>Baud rate</i>	Serial communication baud rate.
PARiTY <i>Parity</i>	Serial communication parity.
Addr <i>Address</i>	Serial communication address.

Table 2 shows the available options for the main screen:

	UPPER DISPLAY	LOWER DISPLAY
Scrn 1	Instantaneous flow rate	Totalized Flow
Scrn 2	Totalized Flow	Instantaneous flow rate
Scrn 3	Instantaneous flow rate	Non-resettable Totalized Flow
Scrn 4	Non-resettable Totalized Flow	Instantaneous flow rate
Scrn 5	Instantaneous flow rate	Unit
Scrn 6	Totalized Flow	Unit
Scrn 7	Non-resettable Totalized Flow	Unit
Scrn 8	Varies between Scrn 5 and Scrn 6	
Scrn 9	Varies between Scrn 5 and Scrn 7	
Scrn 10	Instantaneous flow rate	Auxiliary
Scrn 11	Totalized Flow	Auxiliary
Scrn 12	Non-resettable total flow rate	Auxiliary
Scrn 13	Feeder flow (counting forwards)	Feeder setpoint
Scrn 14	Feeder flow (counting backwards)	Feeder setpoint
Scrn 15	Instantaneous flow rate	Feeder flow (counting forwards)
Scrn 16	Instantaneous flow rate	Feeder flow (counting backwards)
Scrn 17	Totalized Flow	Feeder flow (counting forwards)
Scrn 18	Totalized Flow	Feeder flow (counting backwards)

Table 2 – Main screen options

For screens that show totalizations, whether it is the total or the non-resettable value, when the reading cannot be shown in six digits it will be shown in two halves; that is, the lower six digits and the higher five digits (preceded by a **H** to indicate it is the high half) will be displayed in turns every five seconds.

In case no alarm is configured as "feeder", a "-----" will be displayed.

Table 3 shows the options for digital input and the **G** key.

oFF	No function.
rStot	Totalization reset.
HoLd.In	Freezes display while the input is active, or the key is pressed.
rStMin	Resets minimum and maximum values.
FEEDER	Start of Feeder function. See FEEDER section.
IgnorE	Suspends totalization, ignoring input signal, but keeps retransmission working.

Table 3 – Options for digital input and the **G** key

INPUT SETUP CYCLE

IntYPE <i>Input Type</i>	Selection the input type.
In4-20 <i>Input 4 to 20 mA</i>	Selection of 4-20 mA input as auxiliary input. Available only if flow input is different than 4-20 mA.
InLL <i>Input Low Limit</i>	Value for the beginning of the auxiliary input range. Available only if the 4-20 mA input is enabled.
InHL <i>Input High Limit</i>	Value for the end of the auxiliary input range. Available only if the 4-20 mA input is enabled.
CutOFF <i>Cut Off</i>	Minimum flow rate for indication. Any flow rate below this value is shown as 0 and will not increment the totalizer.
FLtr.In <i>Filter Input</i>	4-20 mA input filter. Available only if the 4-20 mA input is enabled.
Unit I <i>Unit Instantaneous</i>	Unit for indicating instantaneous flow rate. It also establishes the time base for this measurement in Seconds, Minutes, Hour, or Days (free alphanumeric description): ----- S / m / h / d (Seconds / Minutes / Hour / Days)
Unit t <i>Unit totalizer</i>	Unit for totalized flow rate indication: "-----" (free alphanumeric description).
P.InSt <i>K Instantaneous</i>	K factor to be applied on the flow rate reading through the digital input. Available only if flow input is different than 4-20 mA. Instantaneous K factor has its value set as "pulses per volume".
P.tot <i>K totalizer</i>	K factor to be applied on total volume. When using pulse input, total K factor has its value set as "pulses per volume".
S.root <i>Square root</i>	Square root. Available only if the 4-20 mA input is enabled. The YES option applies quadratic function on the input signal within the limits programmed in InLL and InHL .

SELECTION OF FLOW INPUT TYPE

SENSOR	DESCRIPTION
4 to 20	4-20 mA analog signal.
d.InPn	NPN or tension type digital input.
d.I.PnP	NPN digital input.
Switch	Dry Contact (reed switch) digital input.
PulseUP	Coil signal input (from 30 mVpp).

Table 4 – Input sensor type

Note: For information about reading speed, check [SPECIFICATIONS](#).

OUTPUT SETUP CYCLE

rLL <i>Retransmission Low Limit</i>	Retransmission lower limit. It is the flow rate value that corresponds to the 4-20 mA output lower limit. When rHL is equal to rLL , output is turned off.
rHL <i>Retransmission High Limit</i>	Retransmission higher limit. It is the flow rate value that corresponds to the 4-20 mA output higher limit. When rLL is equal to rHL , output is turned off.
OutErr <i>Output Error</i>	Value to be applied to 4-20 mA output in case of input failure.
PULSE <i>Pulse</i>	Configuration of pulse output. Options are off, volumetric pulse and frequency.
!PULSE <i>Volume Pulse</i>	Volume to be accumulated to generate an output pulse. Available only when pulse output is set to volumetric pulse.
PULSE.t <i>Pulse Time</i>	Time period during which pulse remains active after having reached intended volume. Available only when pulse output is set to volumetric pulse.
FrEqd! <i>Frequency Divider</i>	Input frequency divider. Available only when pulse input is set to frequency.

When pulse output is set as volumetric pulse, a pulse is generated every time the totalizer accumulates the value programmed on the **!PULSE** screen. For example, if **!PULSE** is programmed to 10, then a pulse will be generated for every 10 units of computed volume.

When pulse output is set to frequency, the output signal will be an input signal divider.

RELAY CONFIGURATION CYCLE

rL 1 Relay 1	Relay 1 function selection: oFF, RL 1, RL 2, RL 3 e RL 4.
rL 2 Relay 2	Relay 2 function selection: oFF, RL 1, RL 2, RL 3 e RL 4.
rL 3 Relay 3	Relay 3 function selection: oFF, RL 1, RL 2, RL 3 e RL 4.
rL 4 Relay 4	Relay 4 function selection: oFF, RL 1, RL 2, RL 3 e RL 4.

If there is need for activating more than one output relay by the same alarm, just assign the desired relays to the desired alarm. Default configuration assigns one relay to its related (same index) alarm (relay 1 for alarm 1, relay 2 for alarm 2, etc.).

CUSTOMIZED LINEARIZATION CYCLE

LinEnbl Linearization Enable	Enables linearization. Applicable only when flow input is 4-20 mA.
InP.01 Input 01	First input point for linearization.
Out.01 Output 01	First output point for linearization.
InP.02 Input 02	Second input point for linearization.
Out.02 Output 02	Second output point for linearization.
:	27 input and output points for linearization.
InP.30 Input 30	Last input point for linearization.
Out.30 Output 30	Last output point for linearization.





HARDWARE CYCLE (MANUAL MODE)

MANUAL Manual mode	Enables manual mode of operation.
CUR.OUT Current Out	Current output status in manual mode.
PUL.OUT Pulse Out	Pulse output status in manual mode.
RL1.OUT Relay 1 Out	Relay 1 output status in manual mode.
RL2.OUT Relay 2 Out	Relay 2 output status in manual mode.
RL3.OUT Relay 3 Out	Relay 3 output status in manual mode. Visible only for the 4 relays model.
RL4.OUT Relay 4 Out	Relay 4 output status in manual mode. Visible only for the 4 relays model.

CALIBRATION CYCLE

All input and output types are factory calibrated. If recalibration is required, it must be performed by a specialist.

If this cycle is accidentally accessed, go through all parameters without changing values.

PASS Password	Access Password entry. This parameter is shown before protected cycles. See item Configuration Protection.
CALib Calibration	Enables calibration.
InLC Input Low Calibration	Entry of value close to the beginning of scale in 4-20 mA input, within scale specified in InLL and InHL .
InHC Input High Calibration	Entry of value close to the end of scale in 4-20 mA input, within scale specified in InLL and InHL .
OutLC Output Low Calibration	On this screen, whenever you press  or  , a standard current close to 4 mA will be applied. Measure current, in mA, and enter it on this screen.
OutHC Output High Calibration	On this screen, whenever you press  or  , a standard current close to 20 mA will be applied. Measure current, in mA, and enter it on this screen.
rStr Restore	Restores factory calibration.

PRCH Password Change	Changes user password.
Prot Protection	Protection level.

CONFIGURATION PROTECTION

The digital panel meter allows configuration protection as determined by user, preventing unauthorized changes.

The Protection (**Prot**) parameter, in the Calibration cycle, determines the protection level to be adopted, limiting Access to cycles, as shown in the table below.

PROTECTION LEVEL	PROTECTED CYCLE
1	Calibration
2	Calibration + Hardware
3	Calibration + Hardware + Linearization
4	Calibration + Hardware + Linearization + Relays
5	Calibration + Hardware + Linearization + Relays + Output Config. + Input Config.
6	Calibration + Hardware + Linearization + Relays + Output Config. + Input Config. + Functions
7	Calibration + Hardware + Linearization + Relays + Output Config. + Input Config. + Functions + Alarm
8	Calibration + Hardware + Linearization + Relays + Output Config. + Input Config. + Functions + Alarm + Main

Table 5 – Configuration Protection Levels

ACCESS PASSWORD

To access the protected cycles, it is necessary to enter an **Access Password** that allows altering the configuration of parameters in these cycles.

The access password is entered in the **PASS** parameter, which is shown in the first of protected cycles.

Without a protection password, parameters of the protected cycles can be only viewed.

The Access Password is defined by user in the Password Change (**PRCH**) parameter, shown in the Calibration cycle.

New digital panel meters come from factory with access password "1111".

MASTER PASSWORD

If you forget the access password, it is possible to use the Master Password feature. When this password is entered, users gain access to the Password Change (**PRCH**) parameter and are allowed to specify a new access password to the digital panel meter.

The Master Password consists of the last three digits of the digital panel meter serial number **added** to the number 9000.

For example, for a device with serial number "12154321", master password is "9 3 2 1".

MAINTENANCE

PROBLEMS WITH DIGITAL PANEL METER

Connection errors and inadequate programming are the main problems when using the digital panel meter. A final review should prevent losses and wasting time.

MESSAGE	PROBLEM DESCRIPTION
UUUUU	Value reading is above limits allowed for this sensor or signal.
NNNNN	Value reading is below limits allowed for this sensor or signal.
-----	Open input. No sensor or signal. Also displayed in the "feeder" screens in case no alarm is configured as "feeder".

Table 6 – Error messages

SPECIAL RECOMMENDATIONS

Should your digital panel meter be repaired, exceptional care must be taken with handling. The device must be removed from the case and immediately placed in an antistatic wrap, protected from extreme heat and humidity.

CALIBRATION

Both analog input and output are factory calibrated, and recalibration should not be performed by inexperienced operators. If recalibration of a given range is necessary, proceed as follows.

INPUT CALIBRATION

- Set input type to be calibrated to 4-20 mA.
- Program **InLL** (lower limit) and **InHL** (higher limit) indication parameters to maximum and minimum values of input type.
- Apply to entry a signal corresponding to a known indication and close to its lower limit.
- Enter calibration cycle with correct password.
- Access **InLC** parameter. With and keys, have parameter display show applied value. Then press .
- Apply to entry a signal corresponding to a known indication and close to its higher limit.
- Access **InHC** parameter. With and keys, have parameter display show applied value.
- Press or to exit screen and activate calibration.

OUTPUT CALIBRATION

- Mount a millimeter in the analog control output.
- Enter calibration cycle with correct password.
- Select **oULC** parameter. Use and keys so that the device recognizes the process of calibration of current output.
- Read current in the millimeter and enter it in the **oULC** parameter using and keys. Then press .
- In parameter **oUHC**, use and keys so that the device recognizes the process of calibration of current output.
- Read current in the millimeter and enter it in the **oUHC** parameter using and keys.
- Press or to exit screen and activate calibration.

SERIAL COMMUNICATION

The digital panel meter may be optionally supplied with a RS485 asynchronous serial communication interface for communicating with a supervisor computer (master).

The digital panel meter always operates as slave.

Communication is always initiated by the master, which sends a request to the slave address with which it wants to communicate. The addressed slave takes control and sends a response to the master.

The digital panel meter takes broadcast type commands (addresses to all network instruments). For this type of command, the digital panel meter does not send any reply or acknowledgement.

FEATURES

Signals compatible with RS485 standard. MODBUS (RTU) Protocol. 2-wire connection between 1 master and up to 31 digital panel meters (it is possible to address up to 247 units) in bus topology.

Communication signals are electrically isolated from the rest of the digital panel meter.

- Maximum connection distance: 1000 meters.
- Selectable speed; 8 bits of data; 1 stop bit; selectable parity (no parity, even or odd).
- Start time of response transmission: 100 ms maximum after receiving the command.

ELECTRICAL CONNECTIONS: RS485 INTERFACE

RS485 signals are:

D1	D	D+	B	Bi-directional data line	Terminal 25
D0	\bar{D}	D-	A	Reverse bi-directional data line	Terminal 26
C				Optional connection that improves communication performance.	Terminal 27
GND					

CONFIGURATION OF SERIAL COMMUNICATION PARAMETERS

Two parameters must be configured for serial use:

bAUsd: Communication speed.

Prty: Communication parity.

Addr: Communication address.

REDUCED REGISTERS TABLE FOR SERIAL COMMUNICATION

COMMUNICATION PROTOCOL

Slave MODBUS RTU protocol supported. All configurable parameters of the digital panel meter may be read and/or written through serial communication. Writing on registers in broadcast mode using the address **0** is also allowed.

The following Modbus commands are available:

03 - Read Holding Register	06 - Preset Single Register
05 - Force Single Coil	16 - Preset Multiple Register

HOLDING REGISTERS TABLE

The following are the most used registers. For further information, refer to the **Table of Registers for Serial Communication** available for download on the digital panel meter website at www.novusautomation.com.

The registers below are read-only. The ones that are available in a floating-point format require two registers for being 32-bit values.

ADDRESS	PARAMETER	REGISTER DESCRIPTION
0000 and 0001	Instantaneous flow rate	Instantaneous flow value in floating point (IEEE-754).
0002 and 0003	Totalized flow	Flow totalization value in floating point (IEEE-754).
0004 and 0005	Non-resettable totalized flow	Grand total flow value in floating point (IEEE-754).
0013 to 0016	Totalized flow	Flow totalization value in integer format (with signal) of 64 bits. The most significant part is in the first register.

0017 to 0020	Non-resettable totalized flow	Grand total flow value in integer format (with signal) of 64 bits. The most significant part is in the first register.
--------------------	----------------------------------	---

SPECIFICATIONS

DIMENSIONS: 48 x 96 x 92 mm (1/8 DIN)

..... Approximate weight: 242 g

PANEL CUTOUT: 45.5 x 93 mm (+0.5 -0.0 mm)

POWER SUPPLY: 100 to 240 Vac/dc ($\pm 10\%$), 50/60 Hz

Optional 24 V: 12 to 24 Vdc / 24 Vac (-10% / $+20\%$)

Maximum Consumption: 7.5 VA

ENVIRONMENTAL CONDITIONS:

Operation Temperature: 5 to 50 °C

Relative Humidity: 80 % max. up to 30 °C

For temperatures above 30 °C, reduce 3% by °C

Internal use; Category of installation II, Degree of pollution 2;
altitude < 2000 m

INPUTS

4-20 mA: Accuracy: $\pm 0.2\%$ of full scale

Dry Contact: Frequency: 0.1 to 10 Hz

Pulse (Tension, NPN or PNP): Frequency: 0.1 to 50000 Hz

..... Amplitude: from 4 V to 24 V

..... Accuracy: ± 30 ppm @ 25 °C

Magnetic Pickup: Frequency: 0.1 to 8000 Hz @ 30 mVpp

..... 0.1 to 50000 Hz @ 250 mVpp

..... Amplitude: from 30 mVpp to 5 Vpp

..... Accuracy: $\pm 0.1\%$ @ 25 °C

Input impedance: 4-20 mA: 150 Ω (+4.5 Vdc @ 20 mA)

OUTPUTS:

4-20 mA: 550 Ω max., 10000 levels

..... Isolation: 250 Vrms

Pulse: Maximum frequency: 100 Hz

..... Voltage: 0 to 30 Vdc

..... Maximum current: 15 mA

..... Isolation: 250 Vrms

OUTPUT RELAYS:

ALM1 and ALM2:

..... SPDT: 3 A / 240 Vac (3 A / 30 Vdc resistive)

ALM3 and ALM4:

..... SPST-NA: 1.5 A / 250 Vac (3 A / 30 Vdc resistive)

ELECTROMAGNETIC COMPATIBILITY:

..... EN 61326-1:1997 and EN 61326-1/A1:1998

SAFETY: EN61010-1:1993 and EN61010-1/A2:1995

Connections suitable for fork-type terminals 6.3 mm.

FRONTAL PANEL: IP65, polycarbonate UL94 V-2

HOUSING: IP20, ABS+PC UL94 V-0

Operation is started: Three seconds after connection to power
supply.

CERTIFICATIONS: CE, UKCA and UL.

IDENTIFICATION

N1500FT -	4R -	485 -	24V
A	B	C	D

A: Digital panel meter model:

N1500FT

B: Output relays:

Nothing shown (basic version with two SPDT relays)

4R (version with two additional SPST relays)

C: Digital Communication:

Nothing shown (basic version with no serial communication)

485 (version with RS485 serial, Modbus protocol)

D: Power Supply:

Nothing shown (basic version, power supply of 100 to 240 Vac)

24V (version with power supply of 12 to 24 Vdc /
24 Vac)

WARRANTY

Warranty conditions are available on our website
www.novusautomation.com/warranty.