

PRECISE-LOG

Multi-Channel Data Loggers



User's Manual

About this Manual

This manual contains operational information for PRECISE-LOG Data Loggers. Please read this manual before using the data loggers.

Limits of Liability and Disclaimer of Warranty:

The manual contained in this document is furnished for informational use only and is subject to change without notice.

Microedge Instruments Inc. shall not be liable for errors contained herein or for incidental or consequential damages in connection with the furnishing, performance, or use of this material.

Copyright and Trademarks

This manual contains proprietary information which is protected by copyright. All rights are reserved. No part of this document may be photocopied, reproduced, or translated to another language without prior written consent of Microedge Instruments Inc.

Microedge Instruments Inc., PRECISE-LOG, SiteView are the trademarks of Microedge Instruments Inc.

All other trademarks and registered trademarks are the property of their respective owners.

Microedge Instruments Inc.
404 – 1688 152nd Street
Surrey, BC
Canada, V4A 4N2



Rev 2.4 May. 2019

Conditions of Sale and Product Warranty

Microedge Instruments Inc. (MEI) and the Buyer agree to the following terms and conditions of Sale and Purchase:

1. Limited Warranty.

MEI warrants its product(s) to be free from defects in materials and workmanship for a period of one year from the date of registered purchase. Any unit which is found to be defective will, at the discretion of MEI, be repaired or replaced.

MEI will not be responsible for the repair or replacement of any unit damaged by user modification, negligence, abuse, improper installation, or mishandling.

MEI reserves the right to alter any feature or specification at any time.

2. Limitation of Liability.

The product must NOT be used in applications where failure of the product could lead to physical harm or loss of human life. Buyer is responsible to conduct their own tests to meet the safety regulation of their respective industry.

IN NO EVENT WILL MEI BE LIABLE TO ANY PARTY FOR ANY DIRECT, INDIRECT, INCIDENTAL, SPECIAL, CONSEQUENTIAL OR PUNITIVE DAMAGES FOR USE OF THE PRODUCT, INCLUDING, WITHOUT LIMITATION, LOST PROFITS OR REVENUES, COSTS OF REPLACEMENT, BUSINESS INTERRUPTIONS, LOSS OF DATA OR DAMAGES RESULTING FROM USE OF OR RELIANCE ON THE PRODUCT, EVEN IF MEI IS EXPRESSLY ADVISED ABOUT THE POSSIBILITY OF SUCH DAMAGES.

3. Extended Warranty.

Extended 2-year warranty service is available to purchase on new products at time of order entry and up to ninety days thereafter. The extended warranty protects you from unbudgeted service expenses and provide additional 2 years of protection at a fraction of the price of a repair.

4. Return Policy.

Defective Product Return:

A Buyer may return a defective product to MEI for repair or replacement, at MEI option, in the event MEI determines that the product is defective. The defective product must be returned to MEI within the warranty period. The Buyer shall be responsible for all shipping costs. Repaired or replaced products are warranted for the balance of the original warranty period, or at least 90 days.

Non-defective Product Return:

Products that are not defective may be returned to MEI within 30 days from the date of shipment. All non-defective product returns are subject to a 20% restocking fee. If the product is unsatisfactory for the application for which it was purchased, MEI shall, at its option, either refund the purchase price paid by the Buyer or replace the product with one that is satisfactory for the application. The Buyer shall be responsible for all shipping costs and restocking fee determined by MEI.

Method of Return:

Prior to returning the product, completely fill out the RMA Application Form, send it to MEI or contact MEI directly for a Return Material Authorization number. All products returned to MEI must be securely packaged in the original shipping materials and reach MEI without damage and shipped in accordance with Applicable laws, rules, and regulations. The products must contain all software and accessories that were shipped to the Buyer in connection with the product.

5. MEI reserves the right to alter any feature or specification at any time.

Notes to Buyer:

If you disagree with any of the above terms or conditions you should promptly return the unit to the manufacturer or distributor within 30 days from date of purchase.

TABLE OF CONTENTS

| | |
|---|-----------|
| ABOUT THIS MANUAL | 1 |
| LIMITS OF LIABILITY AND DISCLAIMER OF WARRANTY: | 1 |
| COPYRIGHT AND TRADEMARKS | 1 |
| 1. INTRODUCTION | 6 |
| 1.1 FEATURES OF THE LOGGER | 6 |
| 1.2 APPROVALS | 6 |
| 1.3 CARE OF THE LOGGER | 7 |
| 1.4 IDENTITY OF THE LOGGER | 7 |
| 1.5 BATTERY | 7 |
| 1.6 RECALIBRATION..... | 8 |
| 1.7 SAFETY WARNING | 8 |
| <i>Maximum Input Voltage Range</i> | 8 |
| <i>Maximum Input Current Range</i> | 8 |
| <i>External Power Supply</i> | 8 |
| <i>Grounding</i> | 8 |
| 2. HARDWARE & MECHANICAL DIMENSION | 9 |
| <i>Logger Diagram:</i> | 9 |
| <i>USB Port Pin-out (Face-In)</i> | 10 |
| <i>Antenna:</i> | 10 |
| 3. CHANNELS AND SENSOR CONNECTIONS | 12 |
| PL-VW – VOLTAGE INPUTS | 12 |
| <i>Channel and Sensor Specifications:</i> | 12 |
| PL-CW – CURRENT INPUTS | 13 |
| <i>Channel and Sensor Specifications:</i> | 13 |
| PL-TW – THERMOCOUPLE INPUTS..... | 13 |
| <i>Channel and Sensor Specifications:</i> | 14 |
| <i>Measure Temperature:</i> | 15 |
| PL-HW – THERMISTOR / RESISTOR INPUTS | 15 |
| <i>Channel and Sensor Specifications:</i> | 16 |
| <i>Measure Resistance:</i> | 16 |
| <i>Measure Temperature:</i> | 16 |
| 4 BASIC FUNCTIONS | 19 |
| BUILT-IN EQUATIONS | 19 |
| MEASURING & LOGGING | 20 |
| <i>Start Time:</i> | 20 |
| <i>End Time:</i> | 20 |
| <i>Sampling Interval:</i> | 20 |
| <i>Logging Mode:</i> | 20 |
| DOWNLOADING DATA | 20 |

| | |
|---|-----------|
| FIELD ACTIVATION | 20 |
| RESET DEVICE | 22 |
| STATUS LED..... | 22 |
| 5. SOFTWARE..... | 23 |
| SYSTEM REQUIREMENTS | 23 |
| COMMUNICATIONS INTERFACES | 23 |
| INSTALL SITEVIEW AND USB DRIVER..... | 24 |
| CONNECT DATA LOGGER..... | 28 |
| ACTIVATE SITEVIEW | 32 |
| MAIN WINDOW FRAME..... | 33 |
| <i>Communication Panel</i> | 33 |
| <i>Menu Bar</i> | 33 |
| <i>Tool Bar</i> | 33 |
| <i>Main Working Panel</i> | 33 |
| <i>Information Log Panel</i> | 34 |
| VIEW LOGGER STATUS | 34 |
| <i>General</i> | 36 |
| <i>Alarm</i> | 36 |
| CONFIGURE LOGGER..... | 37 |
| <i>Description:</i> | 39 |
| <i>Sampling Interval:</i> | 39 |
| <i>On-Board LED</i> | 39 |
| <i>When Memory Full</i> | 40 |
| <i>Time to Start & Time to End</i> | 40 |
| <i>Total Time Span</i> | 40 |
| <i>Enabled</i> | 40 |
| <i>Channel Range</i> | 40 |
| <i>Description</i> | 40 |
| <i>Equation</i> | 40 |
| <i>Cali. Low & Cali. High</i> | 41 |
| DOWNLOAD LOGGER | 43 |
| <i>Filename & Browse</i> | 45 |
| <i>Start Time & End Time</i> | 45 |
| REAL-TIME DISPLAY | 46 |
| <i>Show List</i> | 48 |
| <i>Show Graph</i> | 48 |
| <i>Vertical</i> | 48 |
| <i>Time Span</i> | 48 |
| <i>Dataset</i> | 48 |
| <i>Settings</i> | 49 |
| CALIBRATE A CHANNEL..... | 49 |
| <i>Understand Cali. Low & Cali. High</i> | 49 |
| <i>Decide On-Line or Off-Line Calibration</i> | 50 |
| COMMUNICATE WITH PRECISE-LOG WIRELESSLY | 54 |
| <i>In Standard Server Mode:</i> | 54 |
| <i>In AccessPoint Server Mode:</i> | 56 |

| | |
|-------------------------------|-----------|
| 6. SPECIFICATIONS..... | 59 |
| COMMON SPECIFICATIONS | 59 |
| LOGGING CAPACITY | 60 |

1. Introduction

1.1 Features of the logger

Congratulations on purchasing the PRECISE-LOG series data loggers! These portable battery powered data loggers allow recording information and saving measurements to a 8MB flash memory for later retrieval.

The internal lithium battery provides up to 10 years of instantaneous logging operation when sampling at interval of one minute in stand-alone mode.

PRECISE-LOG data logger can be manipulated by SiteView Windows software for data downloading, logging management, and property configuration. It has USB interface for local communications and a WIFI module for remote access.

PRECISE-LOG data logger features a wide sampling interval range from one second to 12 hours.

The 16-bit analog-to-digital converter makes the measurements more precise and accurate.

Rugged, splash resistant aluminum enclosure makes it excellent in the harshest industrial environment.

Remote data monitoring and downloading through its WIFI module.

1.2 Approvals



All PRECISE-LOG Series data loggers are in conformity with the EN standard(s) listed below:

EN 61000-6-1:[2007]
EN61000-4-2:2009
EN61000-4-3:2006/A2:2010
EN61000-4-4:2012
EN61000-4-5:2006
EN61000-4-6:2014
EN61000-4-11:2004

EN 61000-6-3:[2007]

EN Standards for WIFI module:

EN62311:2008
EN60950-1:2006+A11:2009+A1:2010+A12:2011+A2:2013
ETSI EN300 328 V1.8.1 (2012-06)
ETSI EN 301 489-1 V1.9.2 (2011-09)
ETSI EN 301 489-17 V2.2.1 (2012-09)



For WIFI enabled models:

Contains FCC ID:2ACZO-WIFI1232T,
In Canada: Contains IC: 20326-USRC216

All PRECISE-LOG Series data loggers comply with Part15 of the FCC Rules. Operation is subject to the following two conditions:

1. These devices may not cause harmful interference, and
2. These devices must accept any interference received, including interference that may cause undesired operation.

1.3 Care of the logger

PRECISE-LOG data loggers are designed to work in humid atmospheres of up to 95% RH non-condensing. They should be protected against immersion. The environment temperature should be within – 40 to +70°C (-40 to + 158°F).

1.4 Identity of the logger

Each logger has its own unique serial number, which can be found on the back of the enclosure. The serial number is used to identify the logger and enable us to keep a record of its history like calibrations and warranty. Please reference it in any correspondence with MEI.

1.5 Battery

The battery lasts in excess of 10 years when sampling at 1-minute intervals in stand-alone mode. When the battery is nearing the end of its service life, the on-board status LED will glow in amber each time the logger is sampling the data. The battery indicator on the status window in SiteView software will also display warning of low battery level. The battery operates approximately one or two weeks from the time the logger first indicates a low battery, but we recommend that the battery be changed as soon as the warning is displayed. The battery is factory replaceable only.

1.6 Recalibration

Any PRECISE-LOG data logger is supplied with all channels pre-calibrated and should not require any further recalibration for a period of 12 months.

We recommend the logger be recalibrated every year. You may recalibrate the logger longer than a year depending on your application standard.

You may return the logger to the supplier for recalibration service or recalibrate it on your own via SiteView software.

SiteView software provides two-point calibration for the most of the loggers.

1.7 Safety Warning

Maximum Input Voltage Range

For logger model: PL-VW, PL-TW (WIFI enabled):

The logger is designed to measure single common ground DC voltages in the range up to 20 VDC. Any voltages over this range may cause permanent damage to the device.

Maximum Input Current Range

For logger model: PL-CW (WIFI enabled):

The logger is designed to measure single common ground DC current in the range up to 50 mA. Any current over this range may cause permanent damage to the device.

External Power Supply

When using external power supply (via PC's USB port or thirty party +5 VDC power supply) to power the logger please make sure that the external power supply has the same common ground with the external input process signals.

When using other third party external power supplies, please make sure the voltage of the external power supply is +5 VDC (+/- 5% ripple).

Grounding

The common ground of the PRECISE-LOG data logger is connected directly to the ground of the input process signals and the ground of the external power supply (if applicable).

2. Hardware & Mechanical Dimension

Logger Diagram:

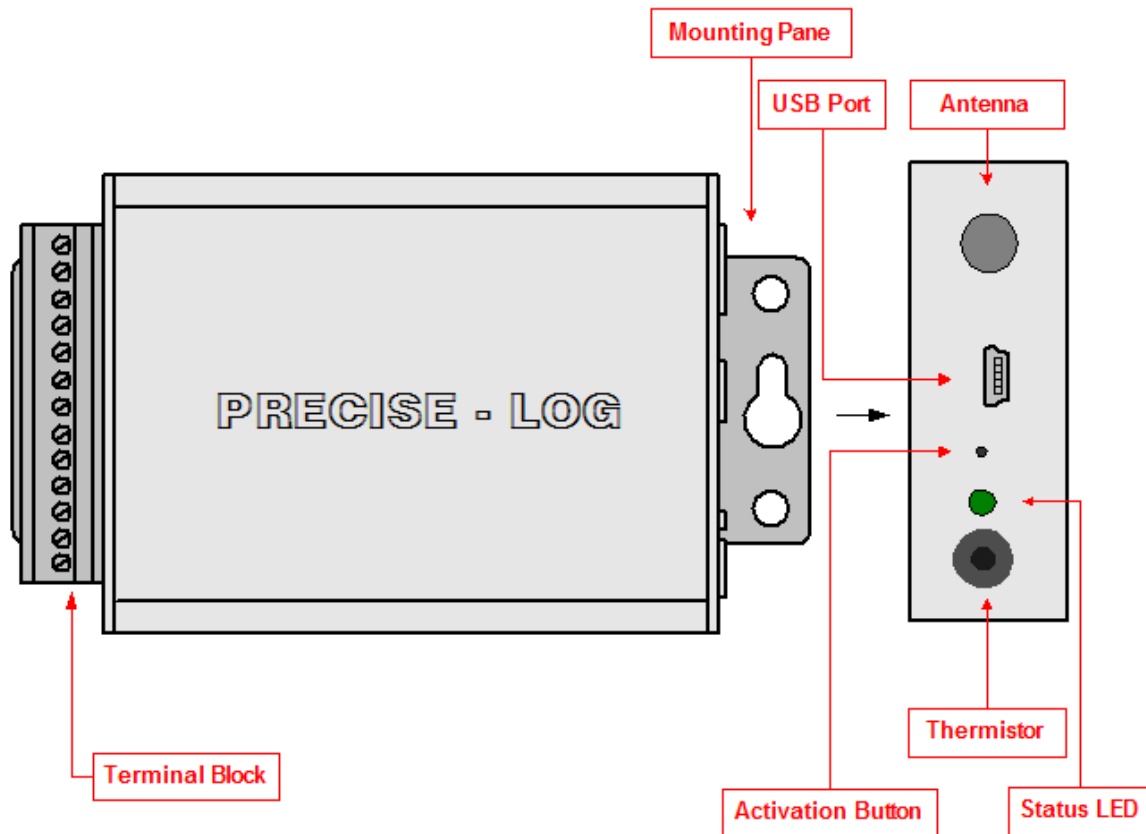

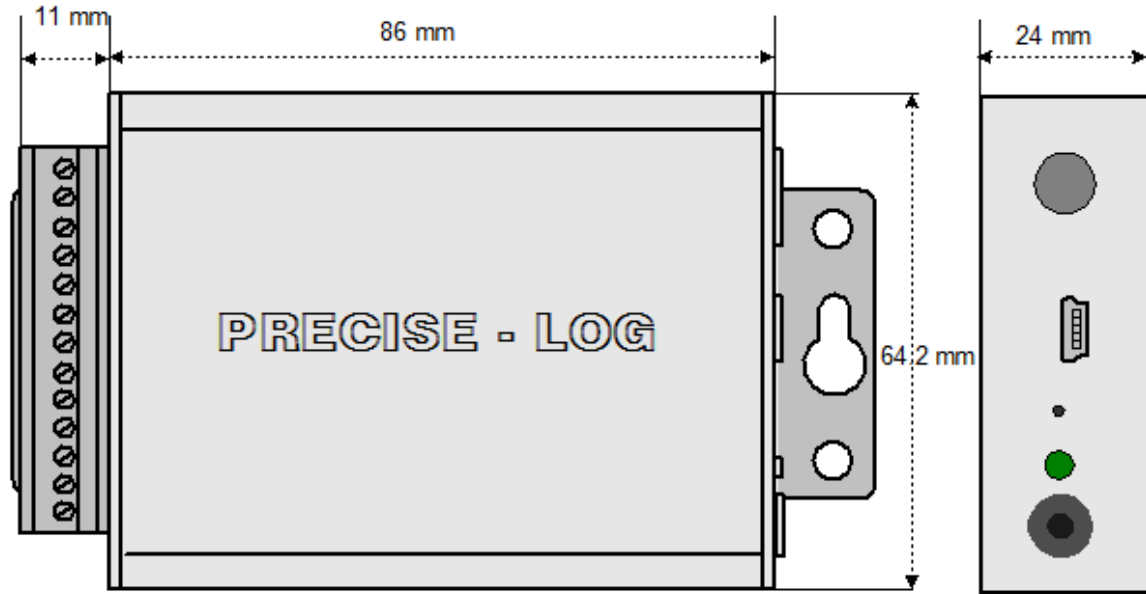

Dimension: 88 X 64.2 X 24 MM
 3.46 X 2.53 X 0.95 Inches

USB Port Pin-out (Face-In)

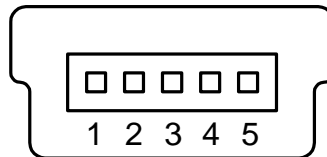

- Pin1: External Power Supply (+5 VDC)
- Pin2: Logger Communications Receiver Line (RX)
- Pin3: Logger Communications Transmitter Line (TX)
- Pin4: Common Ground (COM , GND)

Antenna:

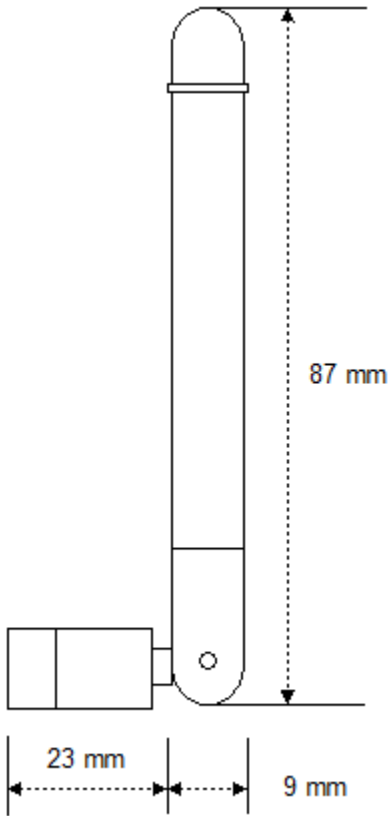

3. Channels and Sensor connections

All “COM” terminals are connected together and should be connected to the common ground of the process signals.

PL-VW – Voltage Inputs

A PL-VW logger has eight external voltage DC channels used to measure single-ended voltage DC signals maximum of 20 volt. The following figure illustrates the correct input connections:

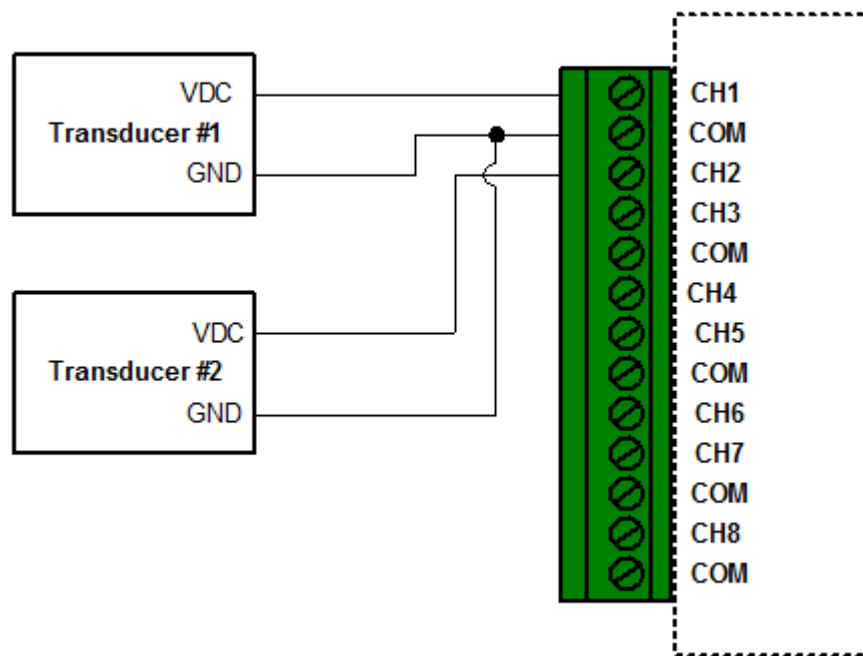

Voltage External Input Connections

Note: All inputs must share the same common ground.

Channel and Sensor Specifications:

| | |
|---------------------------------|--|
| Connections: | Pluggable terminal block for eight external channels |
| Channels: | CH1 to CH8: Eight external Voltage DC with software programmable input range selections for each channel: 0 to 20 V, 0 to 5 V |
| Resolution: | 0.0018% |
| Accuracy: | +/- 0.05% FSR @ 25°C |
| Input Impedance: | > 1 Mohms |
| Over-voltage protection: | +/- 40 VDC |

PL-CW – Current Inputs

A PL-CW logger has eight external current DC channels used to measure single-ended current DC signals maximum of 50 mA. The following figure illustrates the correct input connections:

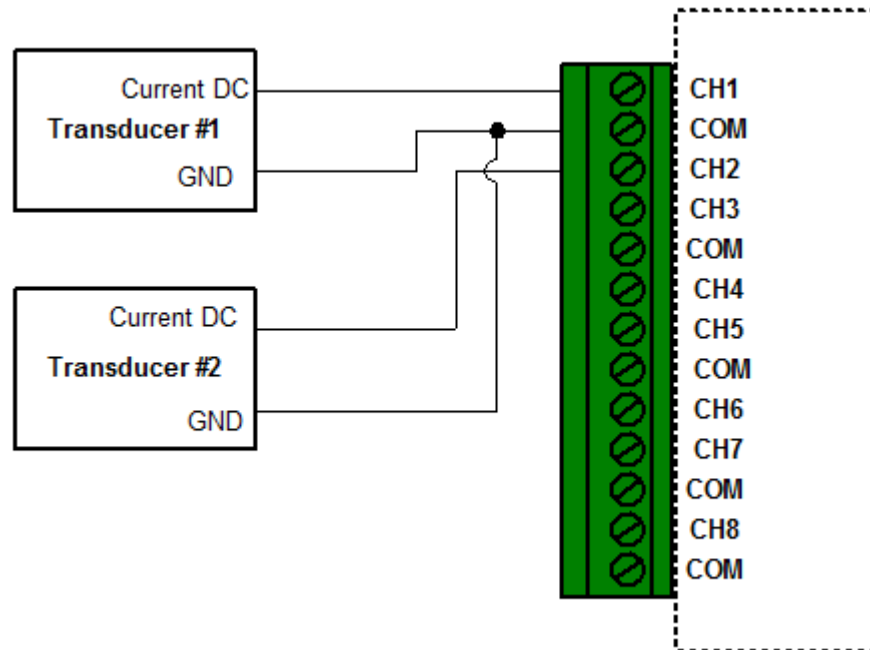

Current External Input Connections

Note: All inputs must share the same common ground.

Channel and Sensor Specifications:

| | |
|--------------------------------|--|
| Connections: | Pluggable terminal block for eight external channels |
| Channels: | CH1 to CH8: Eight external current DC with software programmable input range selections for each channel: 4-20 mA, 50 mA |
| ADC Resolution: | 0.0018% |
| Accuracy: | +/- 0.1% FSR @ 25°C |
| Load Resistance: | 12 Ohm |
| Over-current Protection | +/- 100 mA |

PL-TW – Thermocouple Inputs

Besides the on-board thermistor channel, PL-TW logger has eight external voltage DC channels used to measure thermocouple probes or small voltage signals. The following figure illustrates the correct input connections:

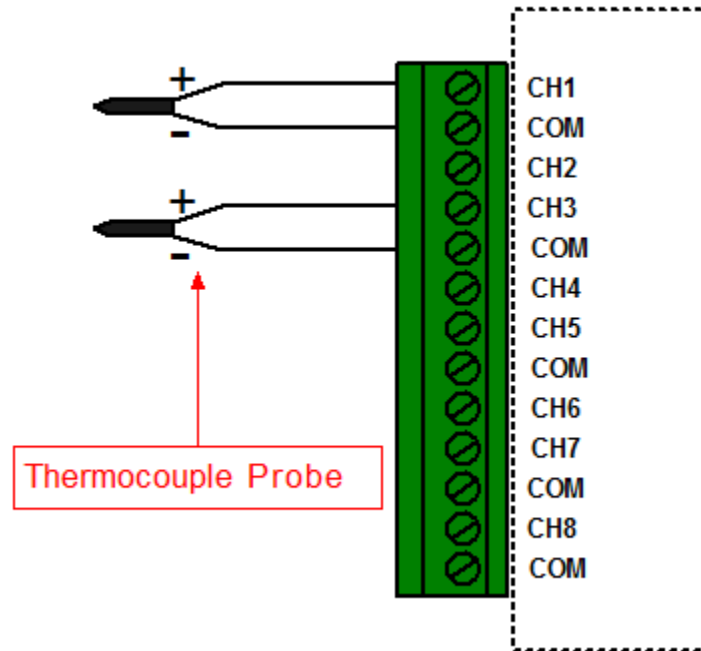

Thermocouple Input Connections

Note: All inputs must share the same common ground.

Channel and Sensor Specifications:

| | |
|----------------------------------|---|
| Connections: | Plugeable terminal block for eight external channels |
| Channels: | CH0: on-board thermistor (-40 ~ +70°C) (-40 to + 158°F). CH1 to CH8: Eight external Voltage DC with software programmable input range selections for each channel: Range1: -8 to +73 mV Range3: -2 to +18 mV |
| Resolution: | 0.0018% |
| Accuracy: | Voltage channels: Range:(-8 to +73 mV: +/- 0.1% (0.08 mV) @ 25°C + T/C Accuracy Range -2 to +18 mV: +/- 0.15% (0.03 mV) @ 25°C + T/C Accuracy |
| Temperature Compensation: | On-board thermistor |
| Over-voltage protection: | +/- 20 VDC |

Measure Temperature:

Based on the thermocouple type you want to use and the desired temperature range you want to measure you can select one of four channel's available ranges and the correct factory thermocouple equation:

| Channel # | Channel Type/Input Range | Enabled | Description | Equation |
|-----------|--------------------------|-------------------------------------|-------------|-------------------------------|
| 0 | Thermistor | <input checked="" type="checkbox"/> | CH0 | Temperature [Temperature] |
| 1 | TC Range1(-8 to +73mV) | <input checked="" type="checkbox"/> | CH1 | VoltageDC [VoltageDC] |
| 2 | TC Range1(-8 to +73mV) | <input checked="" type="checkbox"/> | CH2 | VoltageDC [VoltageDC] |
| 3 | TC Range1(-8 to +73mV) | <input checked="" type="checkbox"/> | CH3 | ThermocoupleE [ThermocoupleE] |
| 4 | TC Range1(-8 to +73mV) | <input checked="" type="checkbox"/> | CH4 | ThermocoupleJ [ThermocoupleJ] |
| 5 | TC Range1(-8 to +73mV) | <input checked="" type="checkbox"/> | CH5 | ThermocoupleK [ThermocoupleK] |
| 6 | TC Range1(-8 to +73mV) | <input checked="" type="checkbox"/> | CH6 | ThermocoupleN [ThermocoupleN] |

For detailed temperature range and voltage – temperature look-up table of a specific thermocouple type please refer to NIST's website at:
<http://srdata.nist.gov/its90/download/download.html>

PL-HW – Thermistor / Resistor Inputs

PL-HW logger has eight external channels used to measure the external thermistors or resistors. The following figure illustrates the correct input connections:

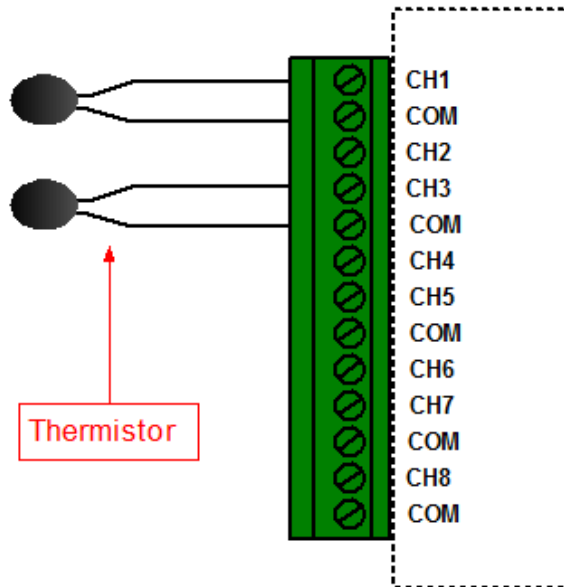

Thermistor External Input Connections

Note: All inputs must share the same common ground.

Channel and Sensor Specifications:

| | |
|---------------------|--|
| Connections: | Plugable terminal block for eight external channels |
| Channels: | CH1 to CH8: Eight external thermistor |
| Resolution: | 0.0018% |
| Accuracy: | Thermistor channel: +/- 0.2°C(0°C ~ 70°C) External channels: +/- 0.2% FSR @ 25°C |

Measure Resistance:

SiteView provides factory resistance equation for measuring the resistor’s value. In Configuration dialog:

Choose Resistance equation:

| Channel # | Channel Type/Input Range | Enabled | Description | Equation |
|-----------|--------------------------|-------------------------------------|----------------------|--|
| 0 | Thermistor | <input checked="" type="checkbox"/> | Office | Temperature [Temperature] |
| 1 | Resistance (>8K) | <input checked="" type="checkbox"/> | Lab with Temperature | Resistance [Resistance] |
| 2 | External Thermistor | <input checked="" type="checkbox"/> | CH2 | Resistance [Resistance] |
| 3 | Resistance (8K) | <input checked="" type="checkbox"/> | CH3 | Digit [ADC Digit Value] |
| 4 | Resistance (8K) | <input checked="" type="checkbox"/> | CH4 | Ave5Points [Average of Previous 5 P... |
| 5 | Resistance (8K) | <input checked="" type="checkbox"/> | CH5 | CO_200PPM [CO 200 PPM Equation] |
| 6 | Resistance (8K) | <input checked="" type="checkbox"/> | CH6 | DewPointEquation [Dew point equatic |
| | | | | ExtThermistor2 [Equation for an exterr |
| | | | | PowerConsume [Power consumption] |
| | | | | StraightLine [Custom Line Test] |

Measure Temperature:

The simple way to measure temperature is by using built-in “Temperature” equation. You select “Temperature” in “Equation” column:

| # | Channel Type/Input Range | Enabled | Description | Equation | Cali. Low | Cali. High | Action |
|---|--------------------------|-------------------------------------|-------------|-------------|-----------|------------|---------------------|
| 0 | Thermistor | <input type="checkbox"/> | CH0 | Temperature | 0 | 0 | |
| 1 | External Thermistor | <input checked="" type="checkbox"/> | CH1 | Temperature | 192 | -176 | Change Coefficients |
| 2 | External Thermistor | <input checked="" type="checkbox"/> | CH2 | Resistance | 39 | -11 | |
| 3 | Resistance (8K) | <input checked="" type="checkbox"/> | CH3 | Resistance | 10 | 11 | |
| 4 | Resistance (8K) | <input type="checkbox"/> | CH4 | Resistance | 0 | 0 | |
| 5 | Resistance (8K) | <input type="checkbox"/> | CH5 | Resistance | 0 | 0 | |
| 6 | Resistance (8K) | <input type="checkbox"/> | CH6 | Resistance | 0 | 0 | |
| 7 | Resistance (8K) | <input type="checkbox"/> | CH7 | Resistance | 0 | 0 | |

Then you need to change temperature coefficient values by clicking “Change Coefficients” button in “Action” column:

| # | Channel Type/Input Range | Enabled | Description | Equation | Cali. Low | Cali. High | Action |
|---|--------------------------|-------------------------------------|-------------|-------------|-----------|------------|---------------------|
| 0 | Thermistor | <input type="checkbox"/> | CH0 | Temperature | 0 | 0 | |
| 1 | External Thermistor | <input checked="" type="checkbox"/> | CH1 | Temperature | 192 | -176 | Change Coefficients |
| 2 | External Thermistor | <input checked="" type="checkbox"/> | CH2 | Resistance | 39 | -11 | |
| 3 | Resistance (8K) | <input checked="" type="checkbox"/> | CH3 | Resistance | 10 | 11 | |
| 4 | Resistance (8K) | <input type="checkbox"/> | CH4 | Resistance | 0 | 0 | |
| 5 | Resistance (8K) | <input type="checkbox"/> | CH5 | Resistance | 0 | 0 | |
| 6 | Resistance (8K) | <input type="checkbox"/> | CH6 | Resistance | 0 | 0 | |
| 7 | Resistance (8K) | <input type="checkbox"/> | CH7 | Resistance | 0 | 0 | |

In the pop-up dialog enter new temperature coefficient values and click “OK” button.

Thermistor Coefficients

A thermistor is a type of resistor whose resistance varies significantly with temperature.

The Steinhart-Hart equation is widely used for thermistors for a wide range of temperatures with high precision:

$$T = \frac{1}{a + b \ln(R) + c \ln^3(R)} - 273.15$$

Where: T is temperature in Celsius
a, b and c are called the Steinhart-Hart parameters also called temperature coefficients
R is resistance in ohms

When you use 'Temperature' equation for any external thermistor channel, you need to specify a, b and c coefficients which you can get from the thermistor manufacturer.

Please enter the following temperature coefficient values:

a: b: c:

If you know three temperature values and their resistance values you can use below button to generate the coefficients.

You can also use a custom equation to do the same job or even more complicated calculation. An example of external thermistor equation is included in SiteView package. When you create your own equation you can refer to this equation and replace those temperature coefficients with the ones obtained from the thermistor manufacturer. The contents of the sample equation looks like this:

```

1
2
3 //An example for external thermistor channel.
4 //You may change a,b and c values based on the thermistor spec
5 //Value 'Input' is resistance value
6 public double ExtThermistor2(double Input)
7 {
8
9     double a, b, c, lgr, Output;
10    //different thermistor will have different a, b, c values
11    a = 0.001028444;;
12    b = 0.000239244;
13    c = 0.000000156;
14
15    //validation
16    if(Input <= 0)
17        Input = 1;
18    //=====
19    lgr = Math.Log(Input);
20
21    Output = 1f / (a + b * lgr + c * lgr * lgr * lgr) - 273.15f;
22
23    return Output;
24
25 }
26

```

Once you have created your equation (for example YSI2252(YSI thermistor 44004)), you can apply it to the channel:

| Channel # | Channel Type/Input Range | Enabled | Description | Equation |
|-----------|--------------------------|-------------------------------------|----------------------|---|
| 0 | Thermistor | <input checked="" type="checkbox"/> | Office | Temperature [Temperature] |
| 1 | External Thermistor | <input checked="" type="checkbox"/> | Lab with Temperature | Thermistor103J2 [Mytest] |
| 2 | External Thermistor | <input checked="" type="checkbox"/> | CH2 | DewPointEquation [Dew point equatic] |
| 3 | Resistance (8K) | <input checked="" type="checkbox"/> | CH3 | ExtThermistor2 [Equation for an exterr] |
| 4 | Resistance (8K) | <input checked="" type="checkbox"/> | CH4 | PowerConsume [Power consumption] |
| 5 | Resistance (8K) | <input checked="" type="checkbox"/> | CH5 | StraightLine [Custom Line Test] |
| 6 | Resistance (8K) | <input checked="" type="checkbox"/> | CH6 | StraightLineLow [Low Temp] |
| | | | | testTemp [Test] |
| | | | | Thermistor103J2 [Mytest] |
| | | | | YSI2252 [YSI thermistor 44004] |

4 Basic Functions

Built-In Equations

Equation and Channel Type are two essential parameters to make sure the physical measurement can be converted correctly.

An equation is a software functionality identified by its name of up to 16 characters. A built-in equation is an equation provided by SiteView software to convert a measurement for a specific channel type.

A channel must have an equation assigned to it in order to make the measurement conversion.

“Digit” built-in equation can be assigned to any channel type. If you assign “Digit” equation to a channel the physical measurement will be the original digital value measured by ADC (Analog-to-digital converter) hardware.

The following table lists all available built-in equations for all channel types:

| Channel Type | Equation Name | Equation Description |
|--|---|--|
| Internal-Thermistor | Temperature | Temperature |
| External-Thermistor | Temperature | Temperature |
| 0-5 VDC | VoltageDC | Voltage DC |
| 0-20 VDC | VoltageDC | Voltage DC |
| 4-20 mA DC | CurrentDC | Current DC |
| 0-50 mA DC | CurrentDC | Current DC |
| Thermocouple Range: -8 to +73 mV | ThermocoupleE ThermocoupleJ ThermocoupleK ThermocoupleN ThermocoupleT VoltageDC | Thermocouple E Thermocouple J Thermocouple K Thermocouple N Thermocouple T Voltage DC |
| Thermocouple Range: -2 to +18 mV | ThermocoupleB ThermocoupleE ThermocoupleJ ThermocoupleK ThermocoupleN ThermocoupleR ThermocoupleS ThermocoupleT VoltageDC | Thermocouple B Thermocouple E Thermocouple J Thermocouple K Thermocouple N Thermocouple R Thermocouple S Thermocouple T Voltage DC |
| X | InternalBattery | Measure the internal battery voltage level |
| X | ExternalPower | Measure the external power supply |

Measuring & Logging

During the session of logging, when it's time to sample, the PRECISE-LOG measures the signal of each enabled channel, converts it to digital value and saves to the on-board memory.

The PRECISE-LOG uses a group of pre-set parameters to decide when and how to take in data and save it to the memory. Those parameters can be configured by SiteView software and their definitions are given as below:

Start Time:

This parameter specifies the date and time when the logger starts the session of logging.

End Time:

This parameter specifies the date and time when the logger will stop the session of logging. This value may be overridden by **Logging Mode** parameter. . If **Logging Mode** was set to **Continue Logging**, the **Start Time** and the **End Time** will be shifted forward.

Sampling Interval:

This parameter specifies the time span the logger will wait after it takes the first sample and before it takes the second sample.

Logging Mode:

This parameter specifies if the logger will stop or continue logging when the memory is full. Available settings are **Stop Logging** and **Continue Logging**.

If **Logging Mode** was set to **Stop Logging**, the logger will stop logging at the **End Time**. If **Logging Mode** was set to **Continue Logging**, the logger will continue logging and the oldest data will be overwritten by the new data.

Downloading Data

The data in the logger can be transferred to the computer by SiteView software even when the logger is still recording

The readings saved in the logger are ADC digital values, and will be converted to physical measurements by SiteView software after they are downloaded to the computer. The data conversion is handled by an equation that may be embedded in SiteView software or a script provided by the user.

Field Activation

PRECISE-LOG data logger comes with an on-board activation button which can be used to activate/initiate the logging session in the field.

To activate the logger for new session:

1. With the SiteView software, open the configuration dialog of the logger, and set the start time to any time the desired start time will never reaches. Click **OK** button to save new settings to the logger.

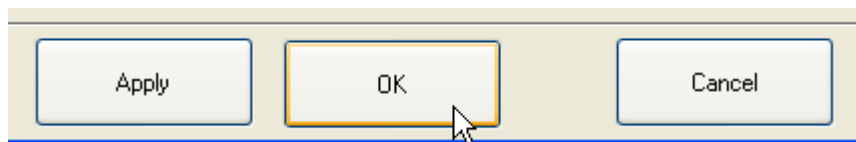
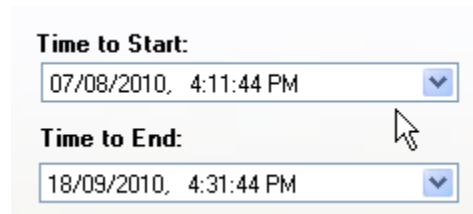

2. The logger is now in **Start Delay** mode. When you need to activate the logger, press and hold the Activation button on the logger. When you see the status LED starts to flash release the button. The logger is now activated and is recording data.

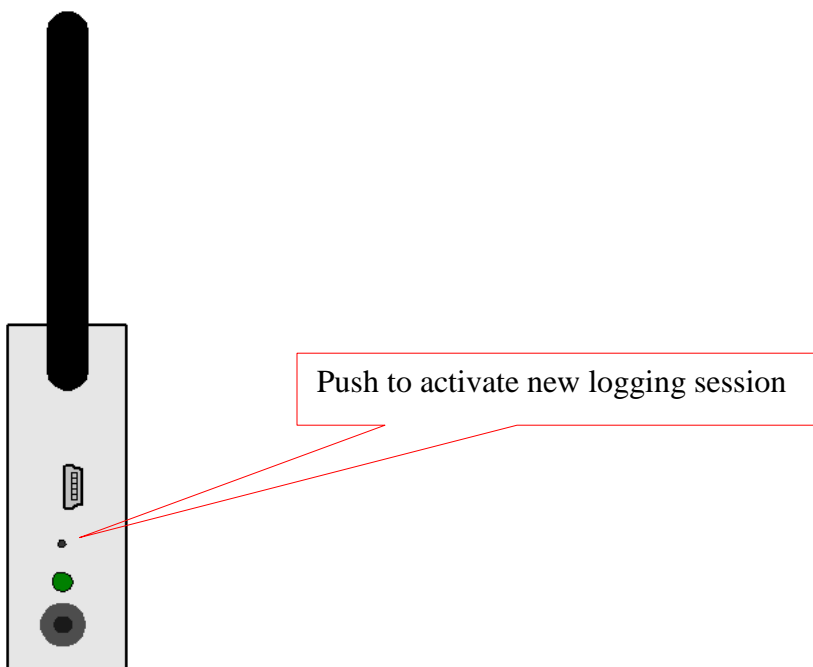

Field Activation

Note: The activation button cannot be further activated once the logger has started the new session.

Reset Device

The on-board activation button can also be used as a reset button in case the data logger does not respond to the PC communications.

Reset of CPU will cause the data and clock losses. Please reconfigure the logger after the recovery.

To reset the CPU, press and hold the activation button, the LED starts to blink in RED color with interval of one second. After 10 seconds the LED starts quick blinking to indicate it will reset the CPU. Release the button when you see this. Then plug the logger to USB port of PC, Site View should show it under the USB comm Tab.

Status LED

PRECISE-LOG logger has an on-board LED used to indicate:

1. Sampling:
When the LED was enabled by SiteView, it will flash once in green when the logger is sampling. The colour of the LED can be overridden by the following conditions:
2. Alarms:
The LED will flash in red when it samples if any channel alarms are enabled and are triggered.
3. Low Battery:
The LED will flash in amber when it samples if the logger detects a low battery level.

If you do not need the LED to indicate the status of operation you can disable it (via SiteView) in order to increase the battery life.

5. Software

SiteView Windows software is used to communicate with the PRECISE-LOG data logger for data downloading, logging management, and channel range configuration.

This section outlines basic functions that SiteView offers. For complete instructions on how to use SiteView software please refer to **SiteView User's Manual** available for download online.

System Requirements

Computer:

- CPU: 1.0 GHZ or above
- Memory: 1 GB or above
- Port: 1 USB port
- Hard Drive: 1GB or above

Operating System:

- Window XP with SP2 or above, Window Vista, Window 7, 8, 10

Communications Interfaces

The PRECISE-LOG logger has a USB port used for communications with a computer. The WIFI enabled version has an on-board WIFI module used for remote communication.

The following schematics illustrate different options that SiteView software can communicate with a data logger.

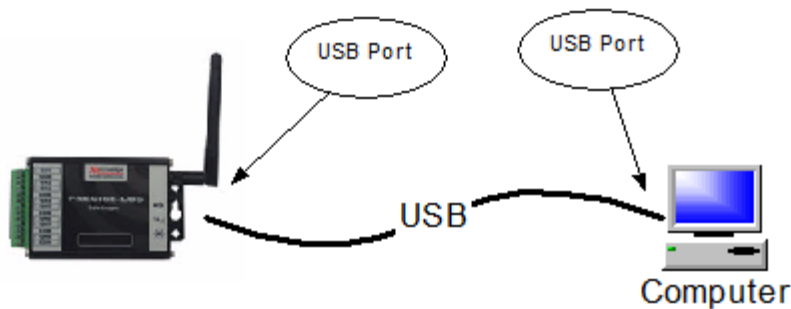

USB Connection



WIFI Wireless Connection (Standard Server Mode)

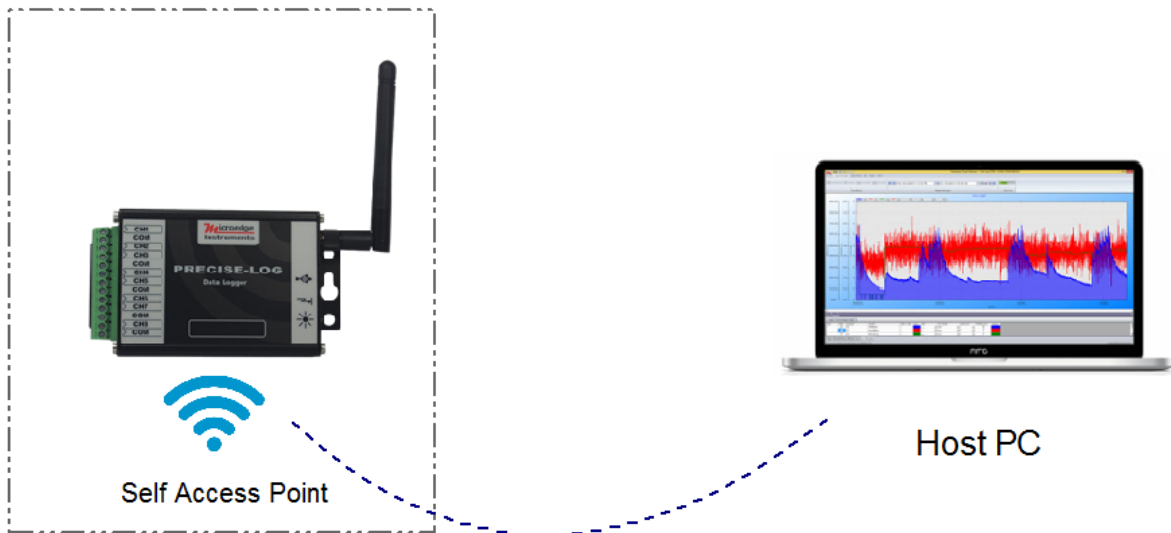

WIFI Wireless Connection (AccessPoint Server Mode)

Install SiteView and USB Driver

1. Install SiteView.

Insert the included CD to the CD Drive. The installation should start to run automatically. Follow the on-screen instructions to complete the installation.

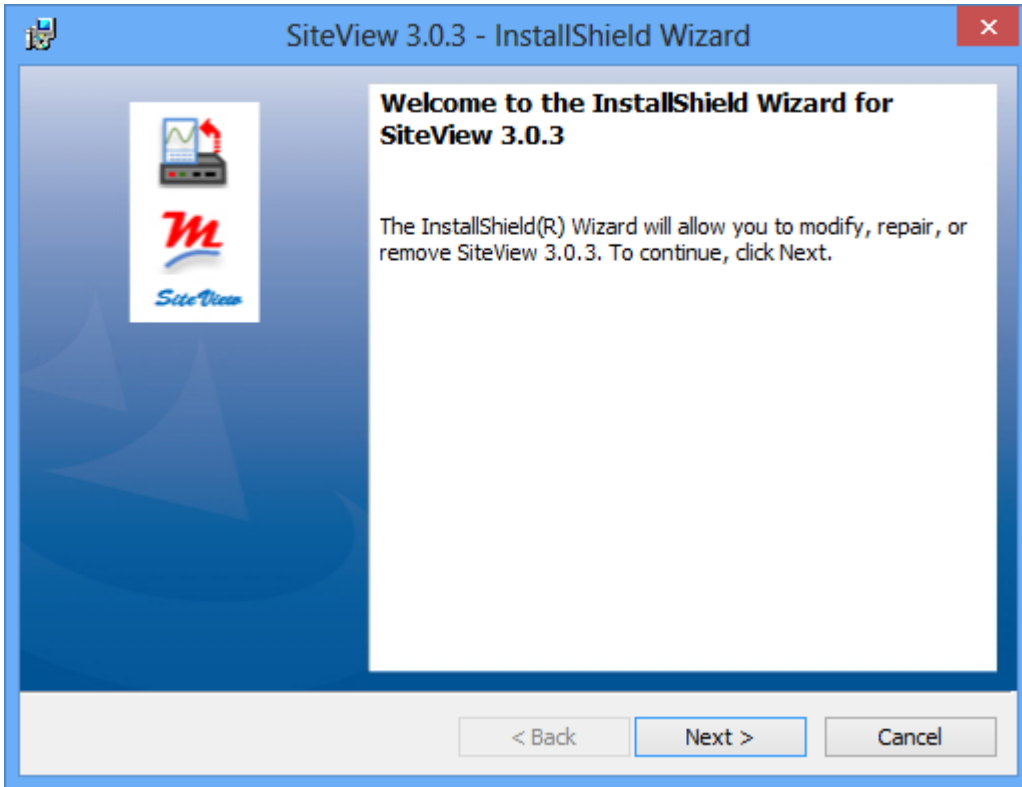

Click “Next >” button to proceed to the next page.

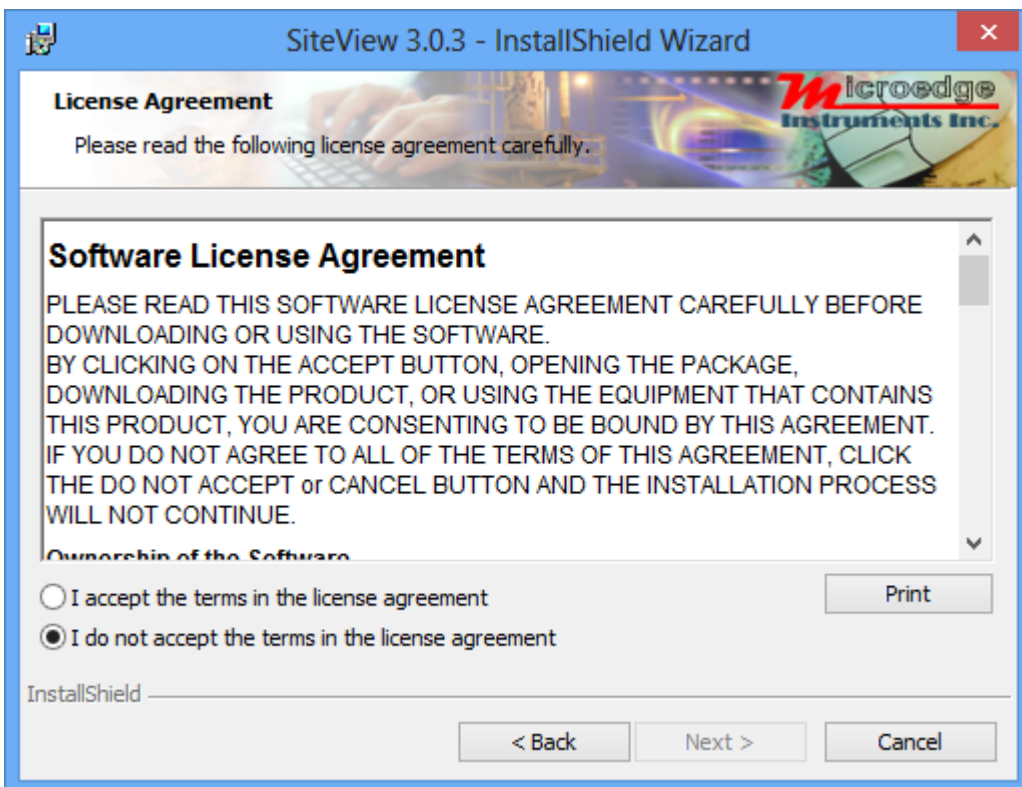

Please read the License Agreement carefully. If you accept the terms click “I Agree”, then click “Next >” button. Otherwise click “Cancel” to cancel the installation.

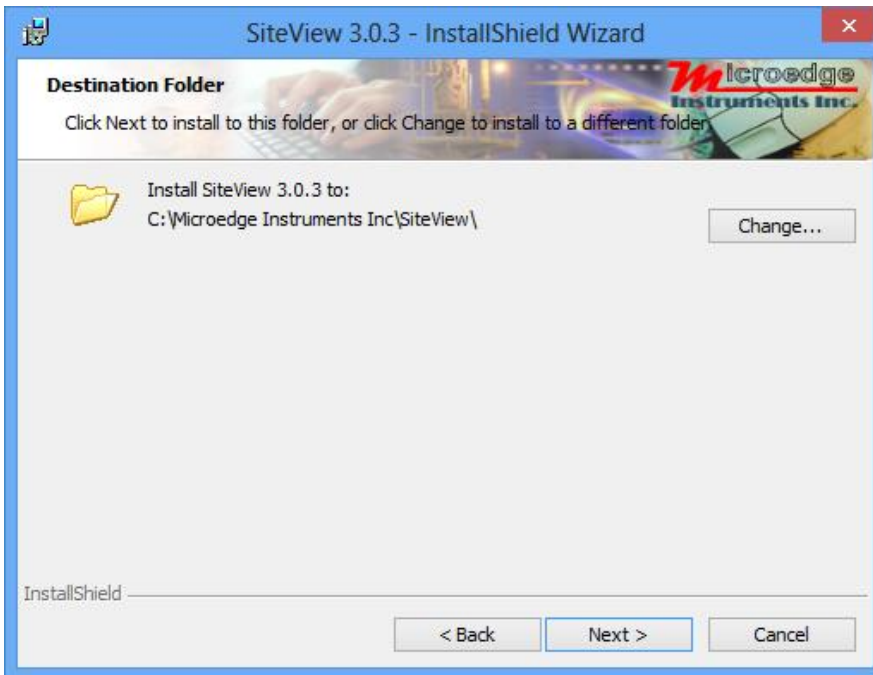

In this dialog select a destination folder where SiteView will be installed. We recommend you keep the default folder.

Once you are ready, click “Next >” button to proceed to the next page.

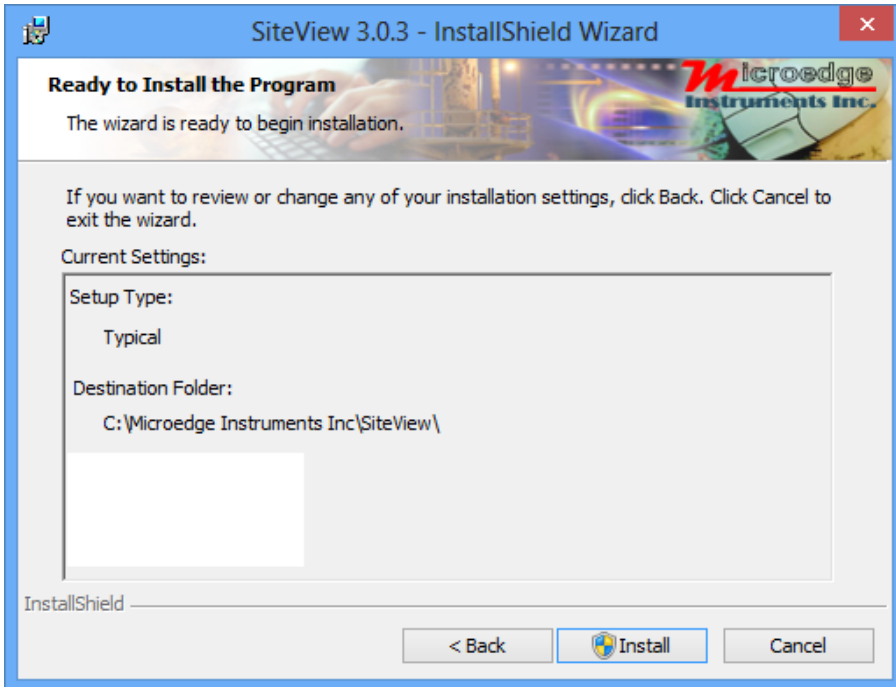

Click “Install” button to start the installation.

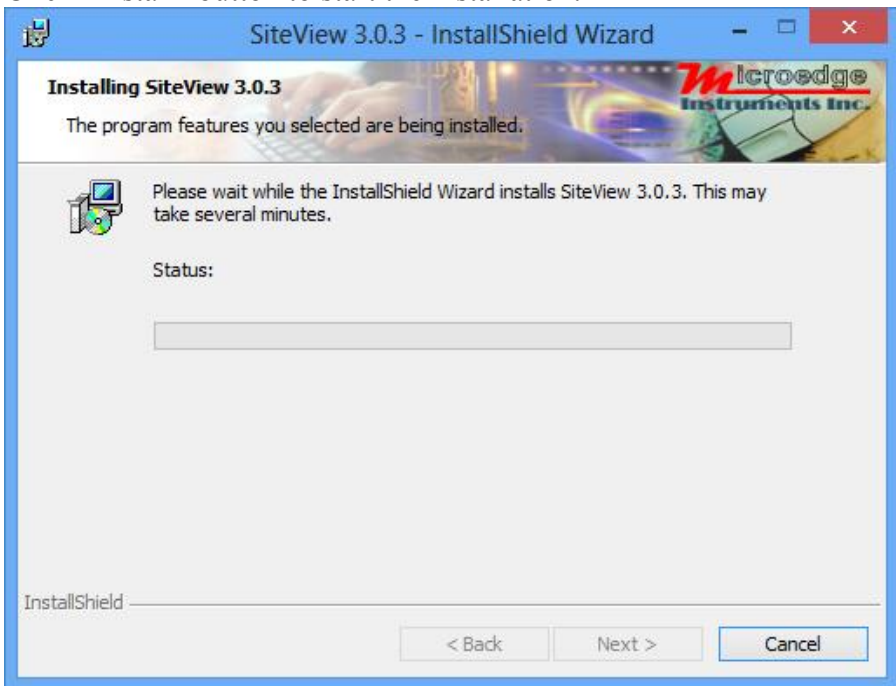

Depending on the operating system, you may see the dialog similar to the one below displayed. Please select “**Continue Anyway**” or “**Install this driver software anyway**” to allow the software and the driver to be installed.

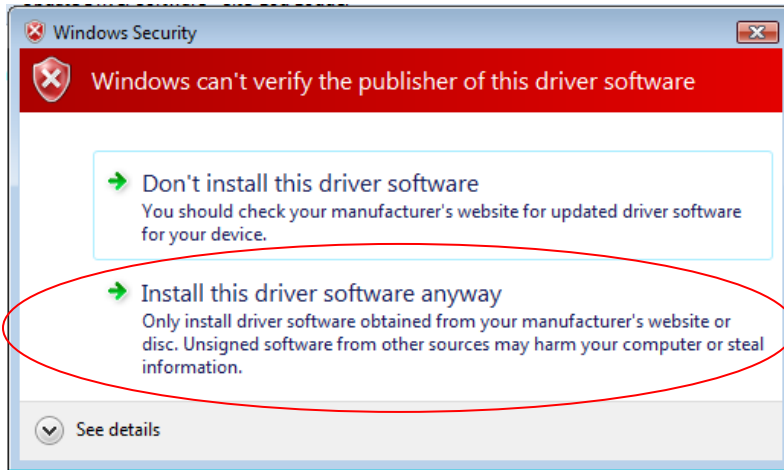

As SiteView is being installed the above dialog shows the installation progress by percentage. Once the installation is complete, the below dialog appears:

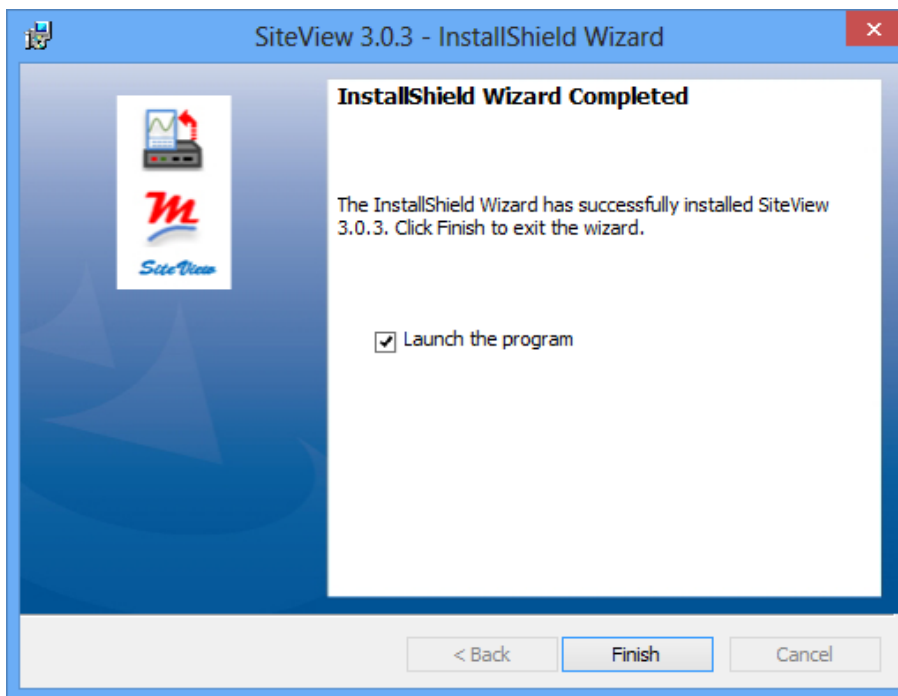

Click "Finish" button to finish the installation and close the dialog.

Connect Data Logger

Connect the logger to the computer's USB port. Windows Vista and Windows 7, 8, 10 will automatically recognize the data logger.

For Windows XP user, the following dialog window will appear:



Select "No, not this time" from options available and then Click "Next >" to proceed with the installation.

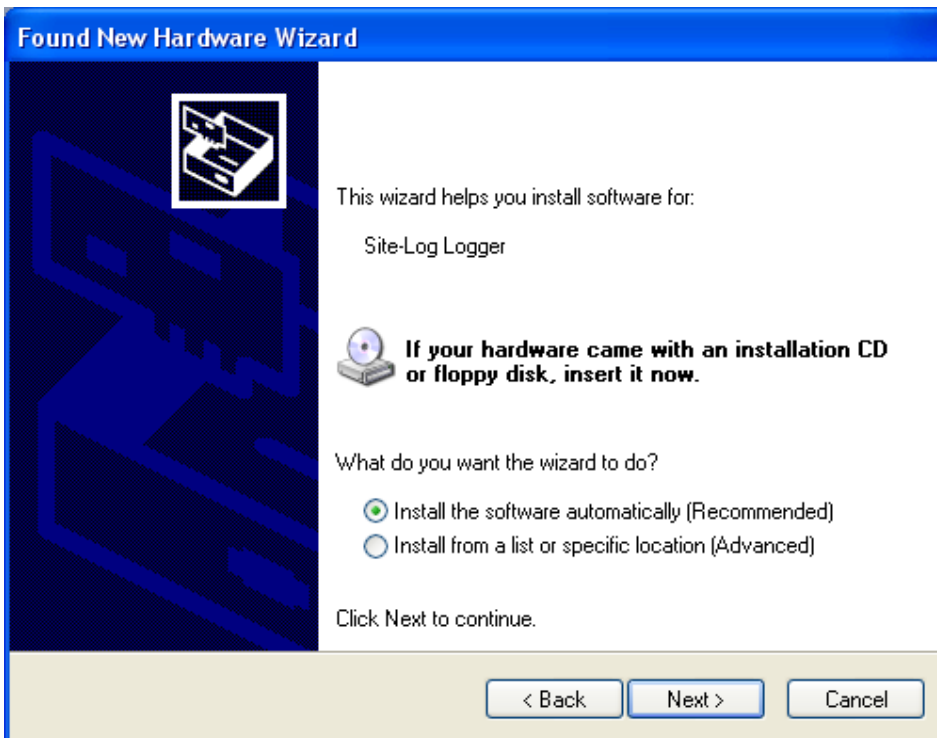

Select "Install the software automatically (Recommended)" as shown in the above figure and then click "Next >".

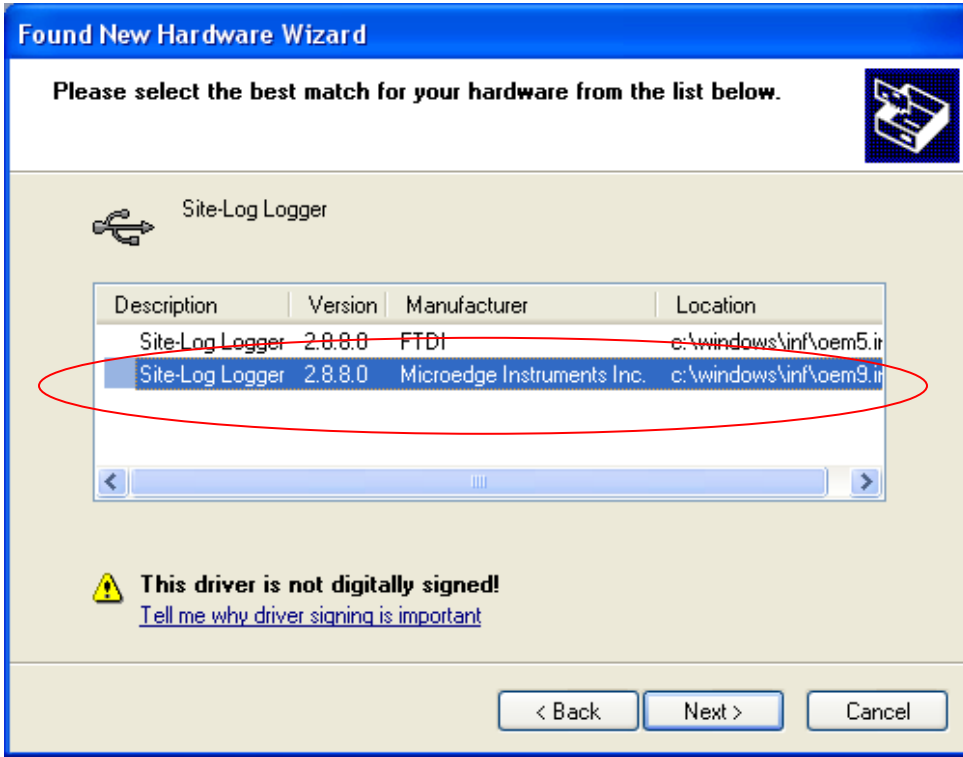

Select the item with Manufacturer of Microedge Instruments Inc and click "Next>" to proceed.

In the following message dialog, click "Continue Anyway" to continue with the installation:



The screen below will be displayed as Windows copies required driver files:

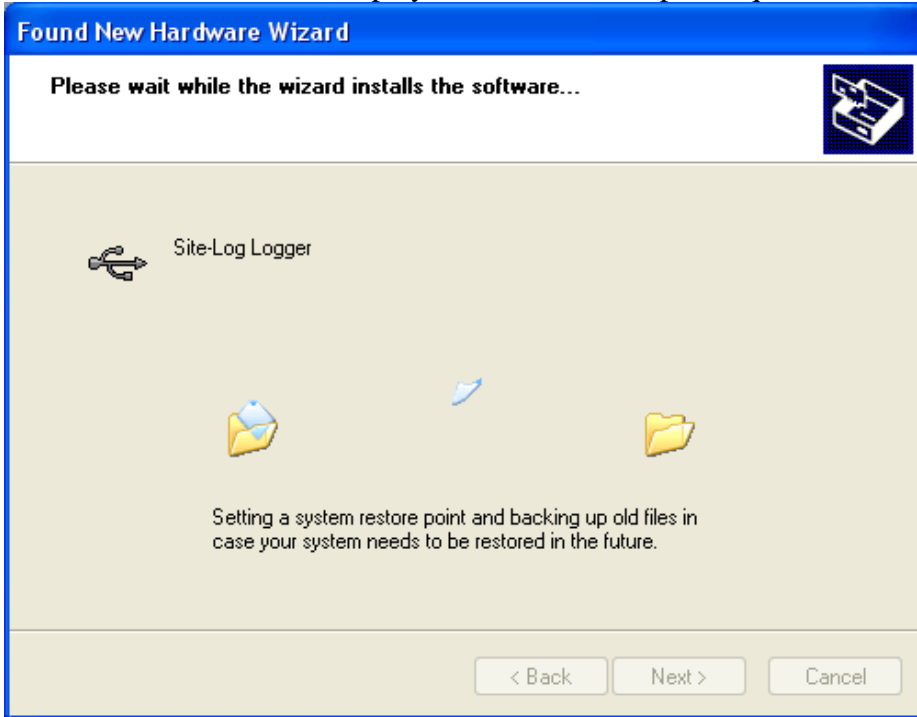

Windows should then display a message indicating the installation was successful:

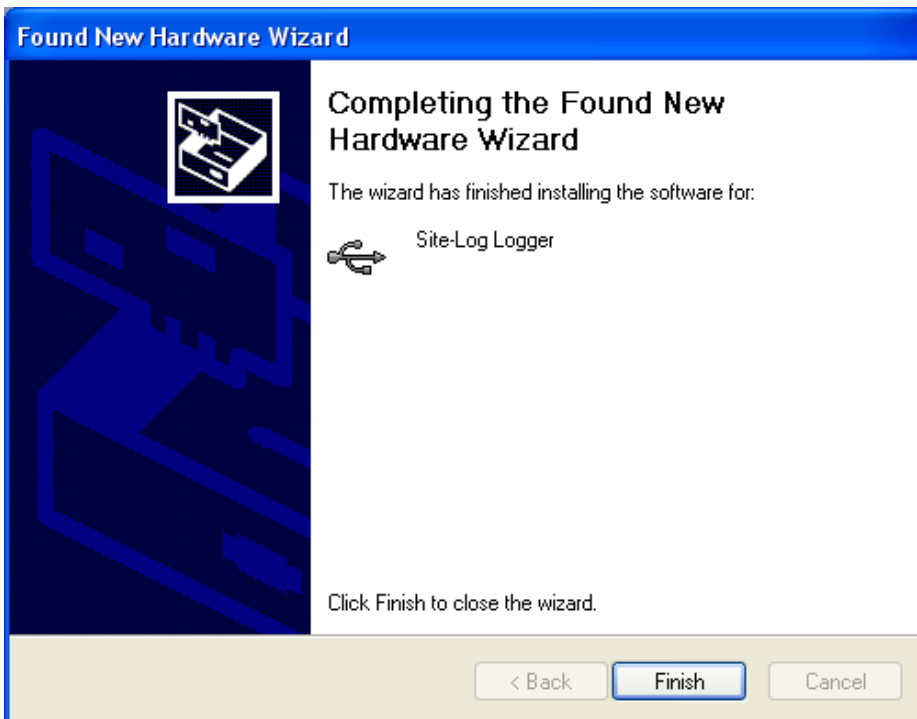

Activate SiteView

After the installation SiteView needs to be activated by entering Product Key you obtained when you bought SiteView.

If the above installation of SiteView was successful, SiteView can be launched by either one of the following methods:

Double click on SiteView icon on the desktop:



Or:

Using Windows Start Menu, select Start : All Programs: Microedge Instruments Inc.: SiteView.

Double click “SiteView” icon on the desktop, and the following dialog appears:

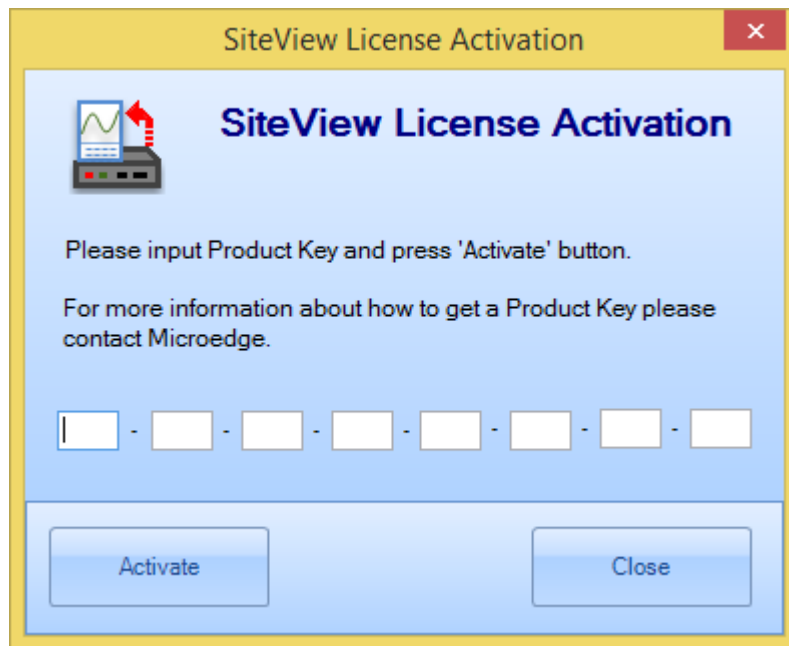

Enter the Product Key, then click the **Activate** button. If the Product Key is accepted the following confirmation dialog will appear:

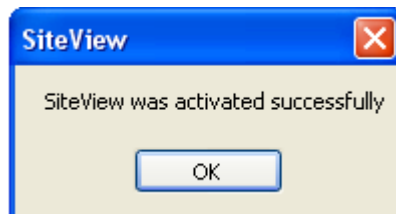

Click **OK** button to finish the activation. From now you can start using SiteView.

Main Window Frame

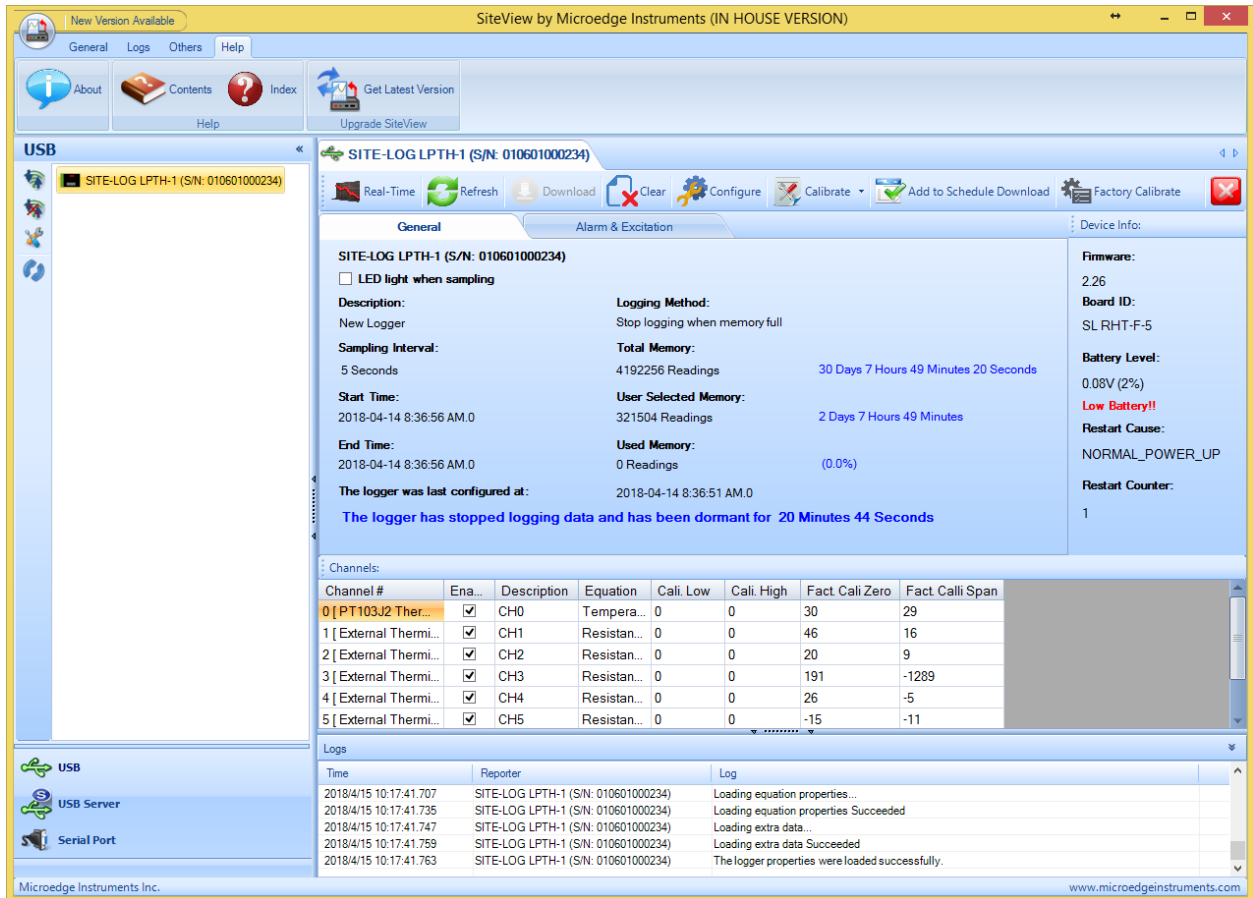

Communication Panel

The communication Panel contains USB, USB Device Server, Serial Port tabs that are used to deal with the respective physical logger connections to the computer. For instance, if the logger is connected to the computer via a USB port you need to use USB tab to communicate with the logger.

Menu Bar

The Menu Bar contains File, View, Tools, and Help menus and their respective sub menus that are used to complete various tasks.

Tool Bar

The Tool Bar provides an easy way to access the menu items by including some of the frequently used items on the tool bar as the tool bar buttons.

Main Working Panel

The Main Working Panel contains a series Tab pages for logger status and the graph information illustrated as the follows:

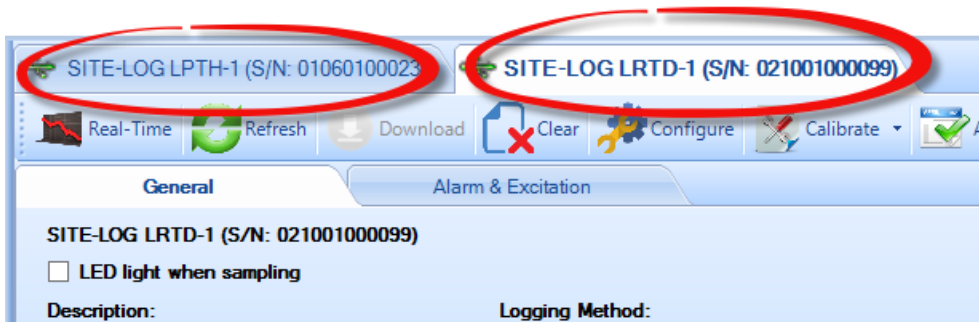

Information Log Panel

This section shows the information logs for any activities SiteView does. This is for diagnostics and information purposes.

View Logger Status

This manual will use USB as an example of communications interface. For other communications interfaces please refer to **SiteView User's Manual** available for download online.

If the logger is connected to the computer correctly the logger icon should show in USB tab of the communication panel illustrated below:

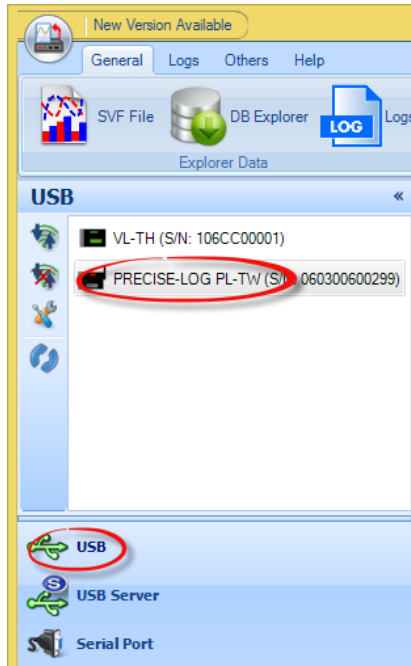

Double clicking **PRECISE-LOG Logger** icon or clicking “Contact” button with the icon been highlighted will bring up the logger status page.

The status page shows the start and end time, sampling interval and other properties of the connected logger:

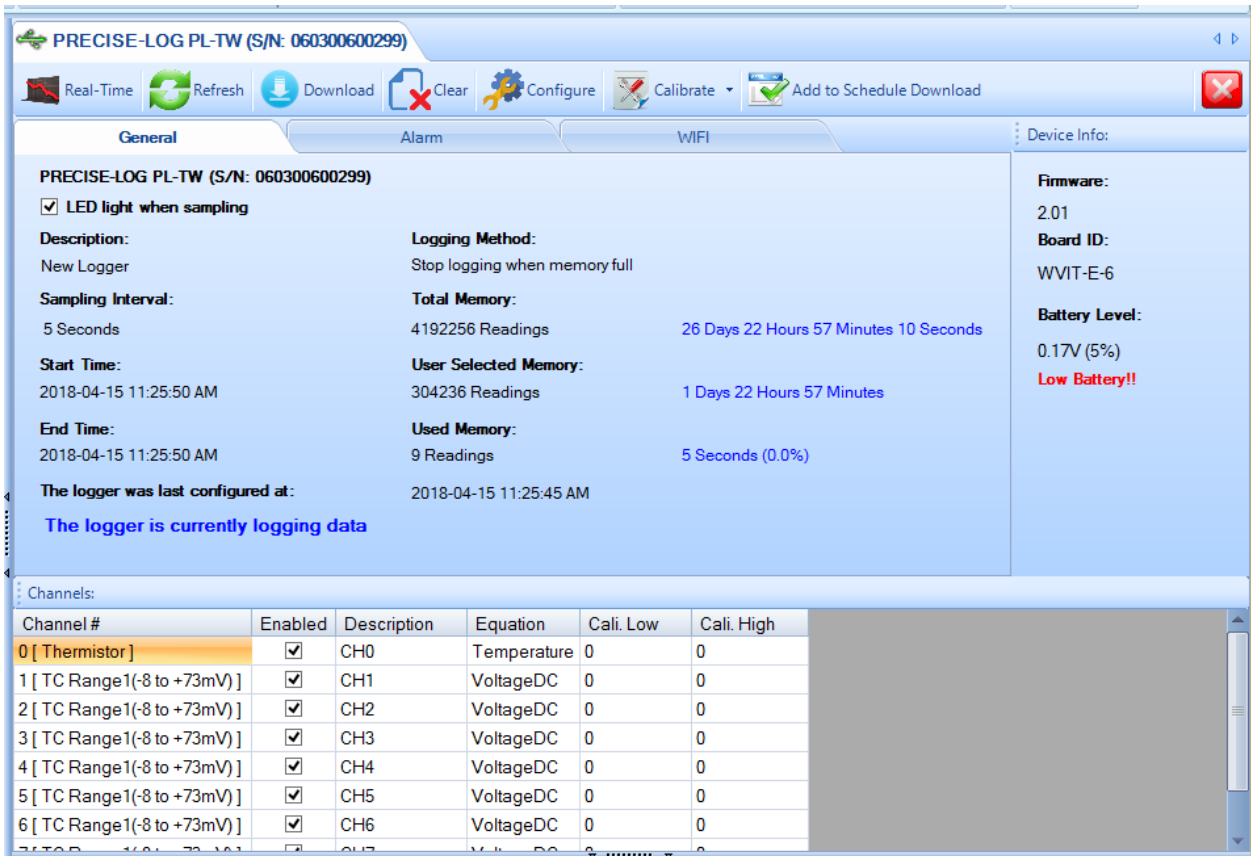

General

This sub tab page displays the general properties of the logger.

Alarm

This sub tab page displays the properties regarding the alarm. By clicking the “Alarm” tab page caption, the following page will appear:

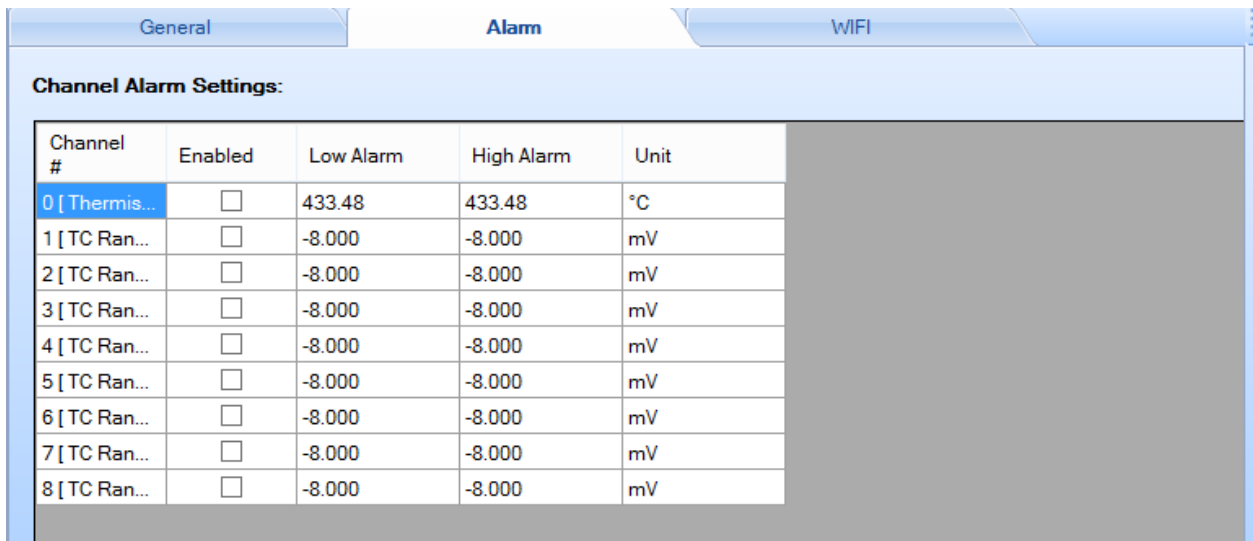

WIFI:

This sub tab page displays the properties regarding the WIFI:

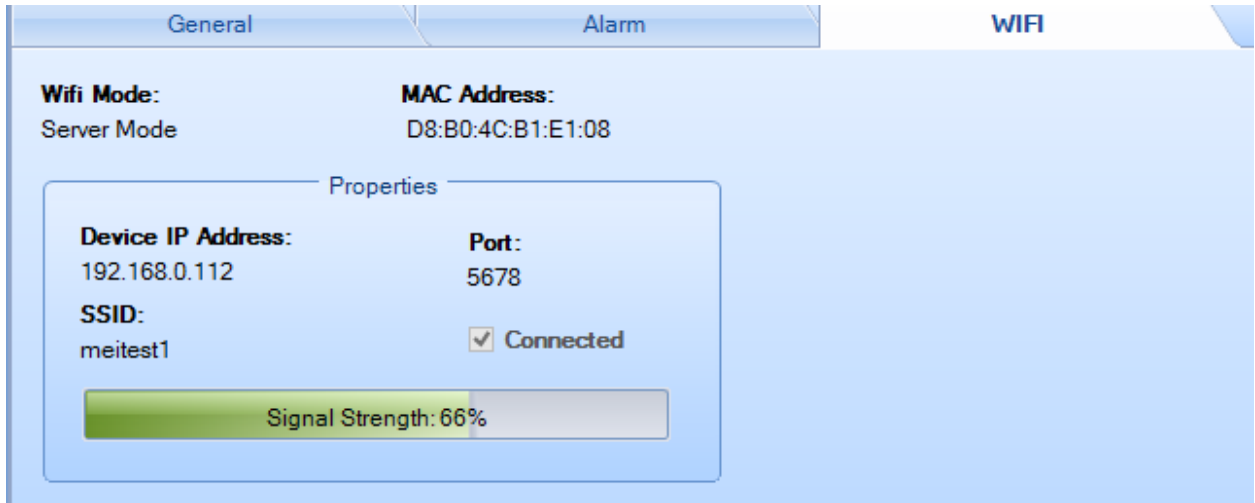

Through the tool bar buttons you can act on other tasks described in the following chapters.

Configure Logger

Configuration of the logger is a procedure to edit the properties of the logger and to start the new logging session.

If you are already in the logger status panel, clicking on the **Configure** button will bring up the configuration dialog window:



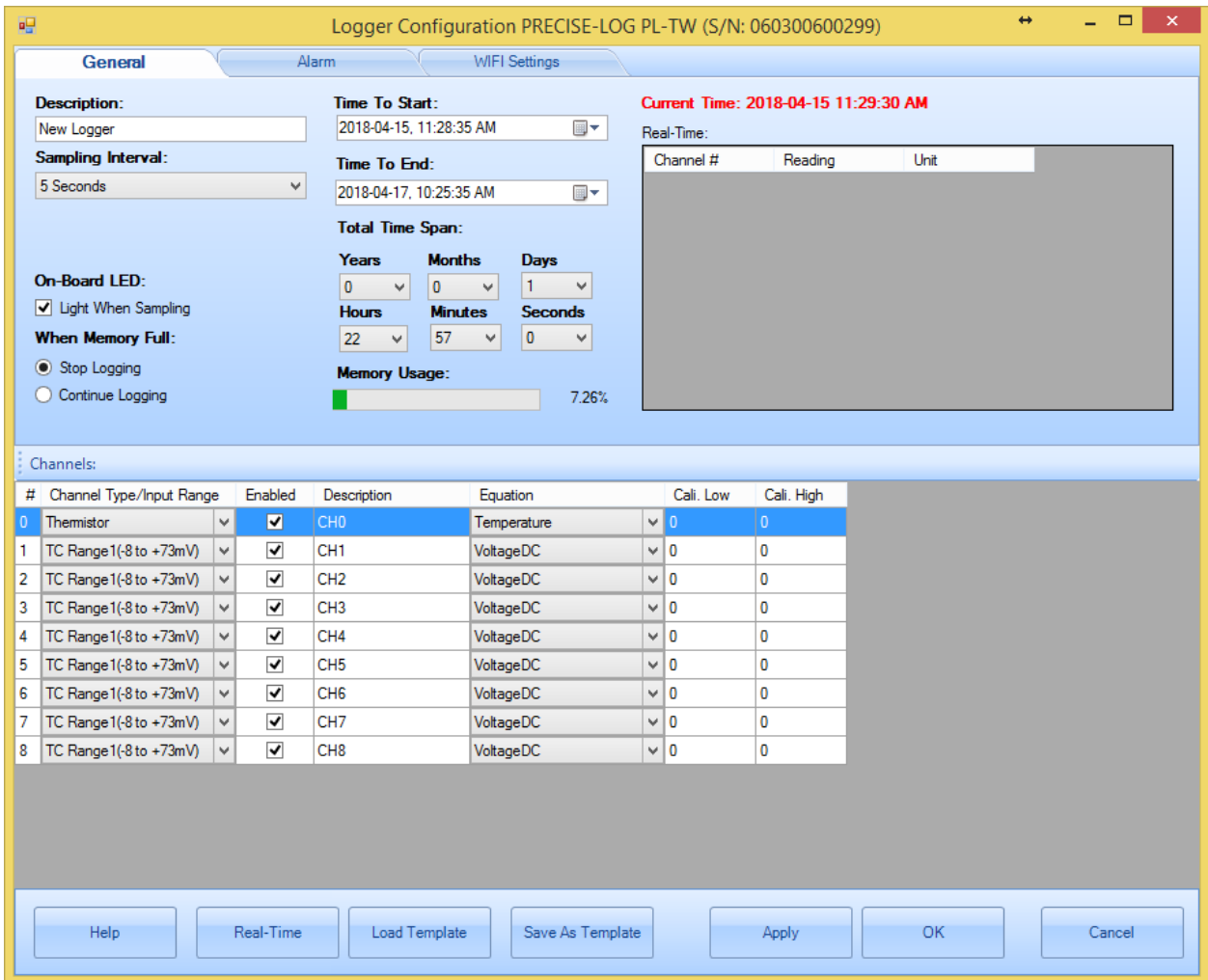

There are three tab pages in this dialog. The **General** page is displayed in the above screen shot. If you click **Alarm** tab the following page will appear:

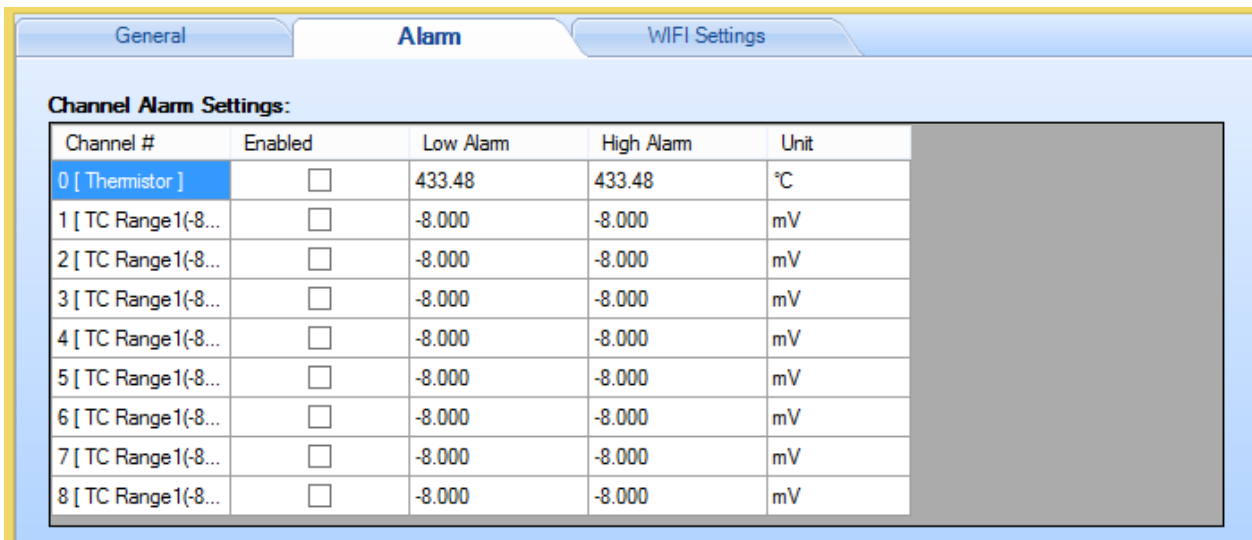

If you click **WIFI Settings** tab the following page will appear:

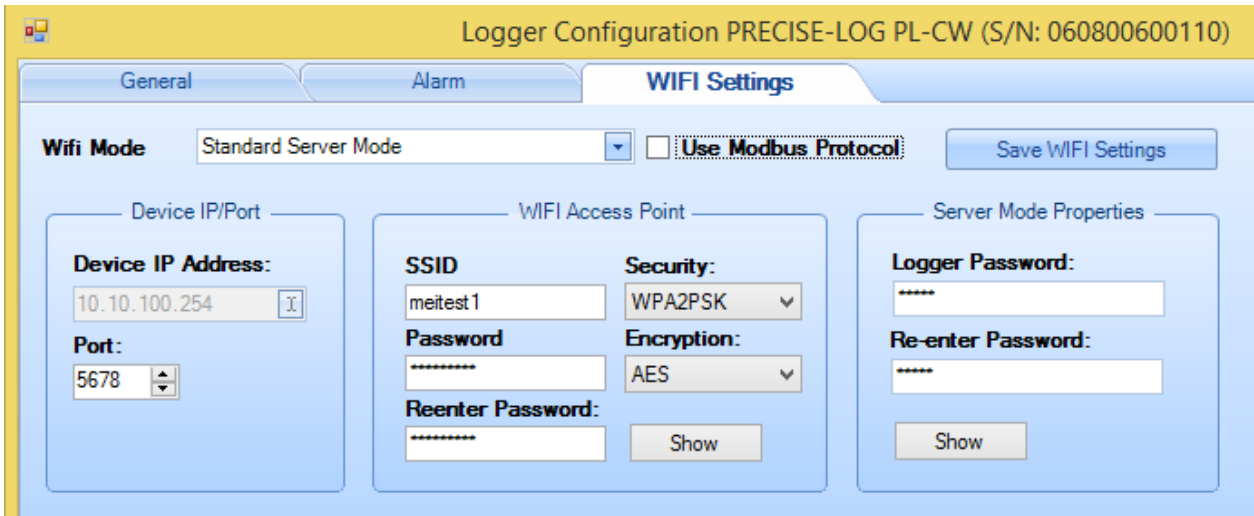

The following fields are for editing:

Description:

Description specifies the information about the logging session with a maximum of 30 characters. It will be the default Title section of the plot in the plot view.

Sampling Interval:

This field specifies the time span the logger will wait between two measurements sampling. Valid settings are:

| Sampling Interval |
|---|
| 1 second to 9 seconds in 1-second increment |
| 10 seconds to 50 seconds in 10-second increment |
| 1 minute to 59 minutes with 1-minute increment |
| 1 hour to 12 hour with 1-hour increment |

Making changes to the Sampling Interval will affect Total Time Span fields.

On-Board LED

Check this field to enable the on-board status LED. If the LED is enabled it will flash each time when it samples data to indicate:

1. The logging is active if the LED flashes in green.
2. The logger is in alarm state if the LED flashes in red.
3. The battery will die soon if the LED flashes in amber.

If you do not need LED indication, you can uncheck this field to increase the battery life.

When Memory Full

If you want the logger to stop logging when the memory is full select **Stop logging**. If you want the logger to continue logging and overwrite the oldest data with the new data (FIFO), you choose **Continue logging**.

Time to Start & Time to End

These two fields specify the desired time the logger will start logging data and the time to stop logging data.

Making changes to the Time to Start/End will affect Total Time Span fields mentioned later.

If you have selected the **Continue logging** field, when the memory is full, both start time and end time will move forward accordingly.

Total Time Span

These fields are an alternate way to specify the total logging time from the start time you specified above.

Changes made on these fields will affect **Time to End** field.

Channel Settings:

Enabled

Check this field to enable this channel for logging.

Channel Range

This field specifies the measurement range the channel will use. Different channel types have different input range selections. Please refer to **Channels and Sensor Connections** chapter for details.

Description

This field specifies the name or the description of the channel (maximum of 30 characters).

Equation

This field specifies the equation used for the channel. Different channel ranges have different default equations. Please refer to **Channels and Sensor Connections** chapter for details.

In order to convert a process signal to a correct measurement value an equation must be applied to the channel.

For example, if you want to use the 0 – 5 VDC channel to record a battery voltage output, the logger will first convert the battery voltage values to digital values and save them in the memory. Later when all data are downloaded to a computer, SiteView will use equation “VoltageDC” to convert the digital values back to voltage values.

If you are recording the voltage output of a transducer or transmitter and the range of the voltage refers to another measurement unit, you will need to create your own equation for this conversion. For instance, if your CO2 transducer outputs 0 – 5VDC representing 0 – 5000PPM of CO2, the custom equation you need to create looks like this:

```
public double CO2Equation(double Input)
{
    double output;
    output = 5000 * Input / 5 ;
    return output;
}
```

For detailed instructions on how to create a custom equation please refer to the **SiteView User's Manual** available for download online.

Cali. Low & Cali. High

These two fields specify the custom calibration values that are used for measurement adjustment.

Cali. Low value specifies the digital value that is over zero when the input value is in the low range value (for 0 – 5 VDC channel the low range is zero volt). The equation will subtract this value from the original digital value when doing the conversion.

Cali. High value specifies the digital value that is over 65535 when the input value is in the high range value (for 0 – 5VDC channel the high range is 5 volt). The equation will subtract this value from the original digital value when doing the conversion.

The valid range for these two parameters is from –32768 to 32767.

These two parameters for each channel were originally set to zero when the logger was first released.

If you have finished the **Cali. Low** and **Cali. High** calibration instructed in the later chapter, the “Cali. Low” and “Cali. High” values may be readjusted.

Alarm

This table specifies how each channel controls alarm state by:

Alarm Enabled: Check this field to associate this channel to the alarm state.

Low & High Alarm: These fields define the alarm thresholds. If the reading is beyond these thresholds, the alarm is triggered.

Channel Alarm Settings:

| CH# | Alarm Enabled | Low Alarm | High Alarm | Unit |
|-----|-------------------------------------|-----------|------------|------|
| 0 | <input checked="" type="checkbox"/> | -134.09 | 110.50 | °C |
| 1 | <input checked="" type="checkbox"/> | -353.3989 | 20568.2460 | mV |
| 2 | <input checked="" type="checkbox"/> | -8.5205 | 10.0501 | mV |
| 3 | <input checked="" type="checkbox"/> | 0.0000 | 0.0000 | mV |
| 4 | <input checked="" type="checkbox"/> | 0.0000 | 0.0000 | mV |
| 5 | <input checked="" type="checkbox"/> | 0.0000 | 0.0000 | mV |
| 6 | <input checked="" type="checkbox"/> | 0.0000 | 0.0000 | mV |
| 7 | <input checked="" type="checkbox"/> | 0.0000 | 0.0000 | mV |

WIFI Settings:**WIFI Mode:****Wifi Function Disabled:** disable the wifi function**Standard Server Mode:** The logger will run as server. Both client PC and the logger will join an existing WIFI Access Point and a client PC can communicate with it.**AccessPoint Server Mode:** The logger will create a WIFI Access Point(AP), then a client PC can join this network and start to communicate with the logger.**Device IP/Port:**

The device's IP address is dynamically assigned by the router. You can specify the port the device will work on.

Wifi Access Point:

This is the wifi network the logger will connect to.

SSID: In Standard Server mode: the name of the wifi network both PC and logger to join.

In AccessPoint Server mode: the name of the wifi is "PL" + "Serial Number of the Logger"

Password: The password of the wifi network**Security:** You can specify the following security: Open, Shared, WPAPSK, WPA2PSK.**Encryption:** You can specify the following encryption: None, WEP-H, WEP-A, TKIP, AES.**Server Mode Properties:**

You can specify a password at the logger level to prevent other clients from accessing logger.

Use Modbus Protocol:

If you want to turn the data logger into a Modbus server communicating with Modbus client/master, you can check this entry.

Save WIFI Settings:

Click this button to save wifi related settings to the logger. Then the logger will blink in amber to indicate it is trying to connect to the wifi network. Once it successfully connected to the network it will stop amber blinking and return to the normal operation.

Once you have finished making changes to the available settings, you can click **OK** button to save the settings to the logger. The logger will start to record data from **Time to Start** you have set.

Note: clicking on OK or Apply buttons will erase all existing measurements saved in the logger.

For a detailed description of each available setting please refer to the **SiteView User's Manual** available for download online.

Download Logger

If you are already in logger status tab, clicking on "Download" button will bring up **Download** dialog window:

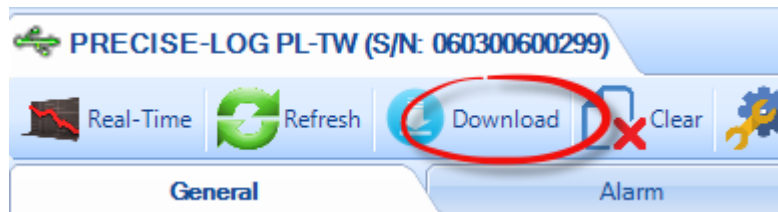

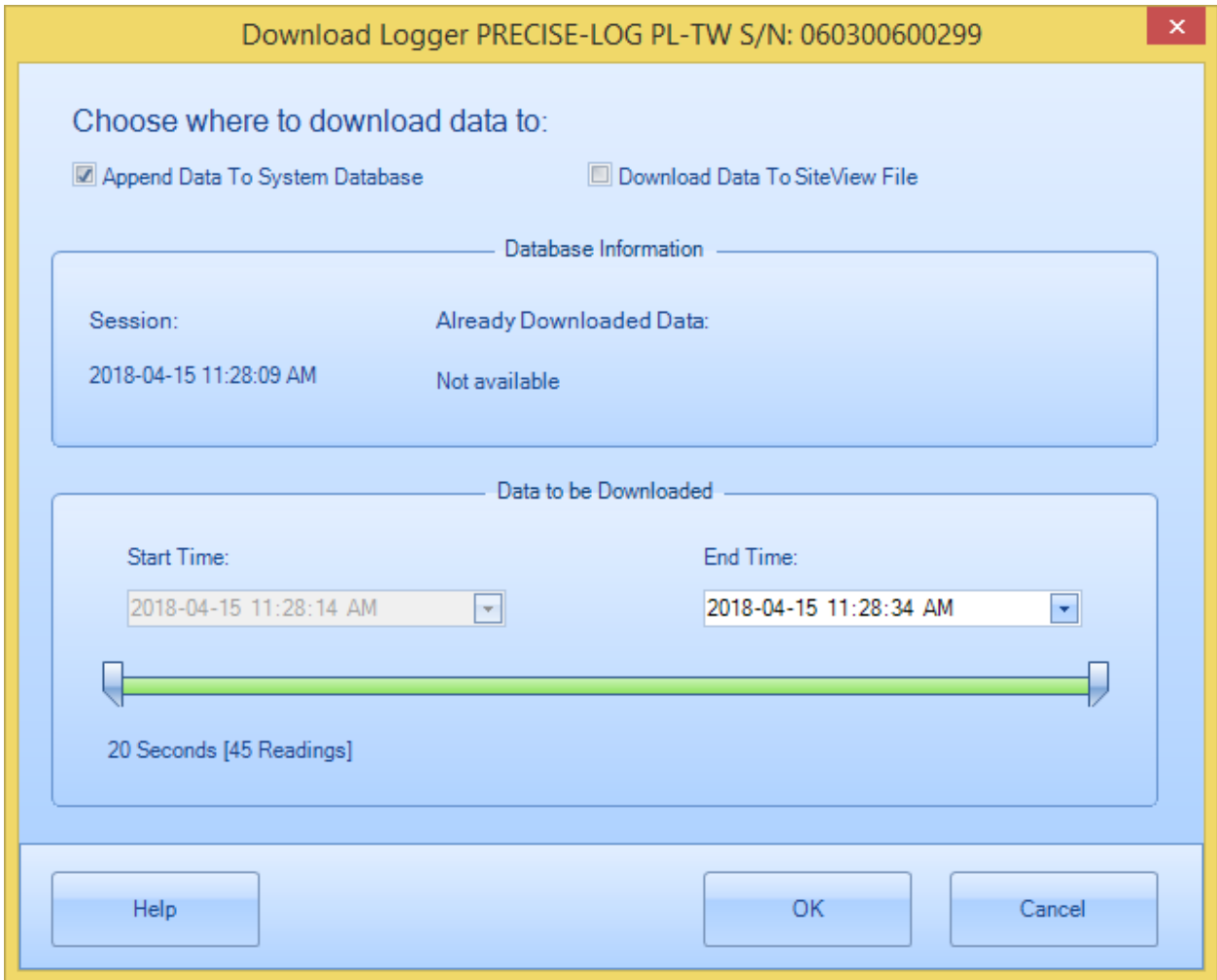

Started from Site View 3, data can be downloaded to the system database. Each data logger has a life-time database file associated to it. If you choose to “Append Data to System Database” you can specify End Time and start to download the data.

If you choose to download data to a separate Site View file, the user interface looks like:

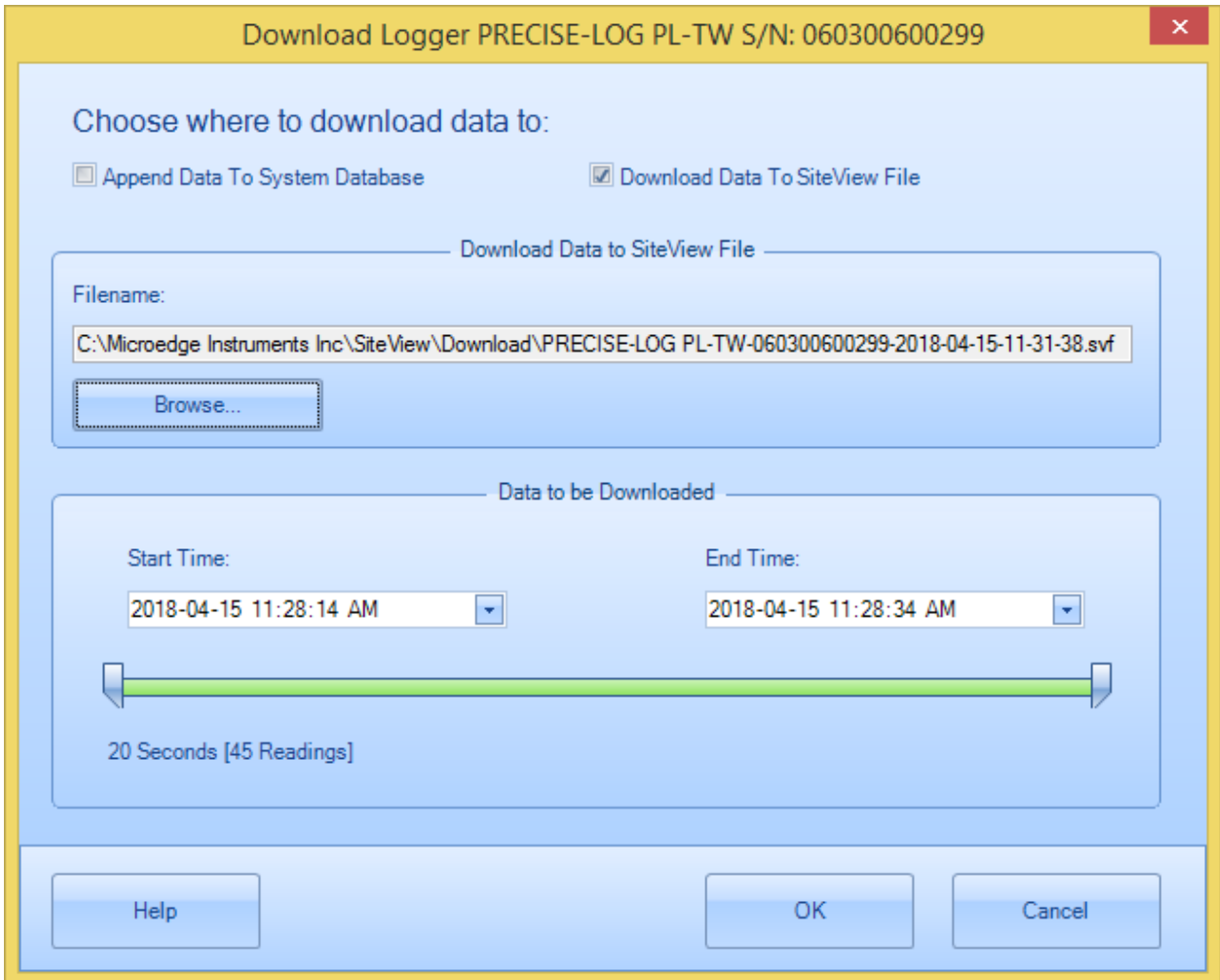

The fields that you can edit are:

Filename & Browse

These fields specify the full file path the downloaded data will be saved into.

Clicking on **Browse** button will display **File Save** dialog where you can edit or choose a file name.

Start Time & End Time

These fields specify the desired start and end time for the data to be downloaded. You can use either scroll bars or the calendar controls to change the start and end time.

Once you have selected a desired time frame you can click **OK** button to start the download process.

After the download the plot and tabular data will be displayed (If **Display plot after download** was not checked the plot will not display):

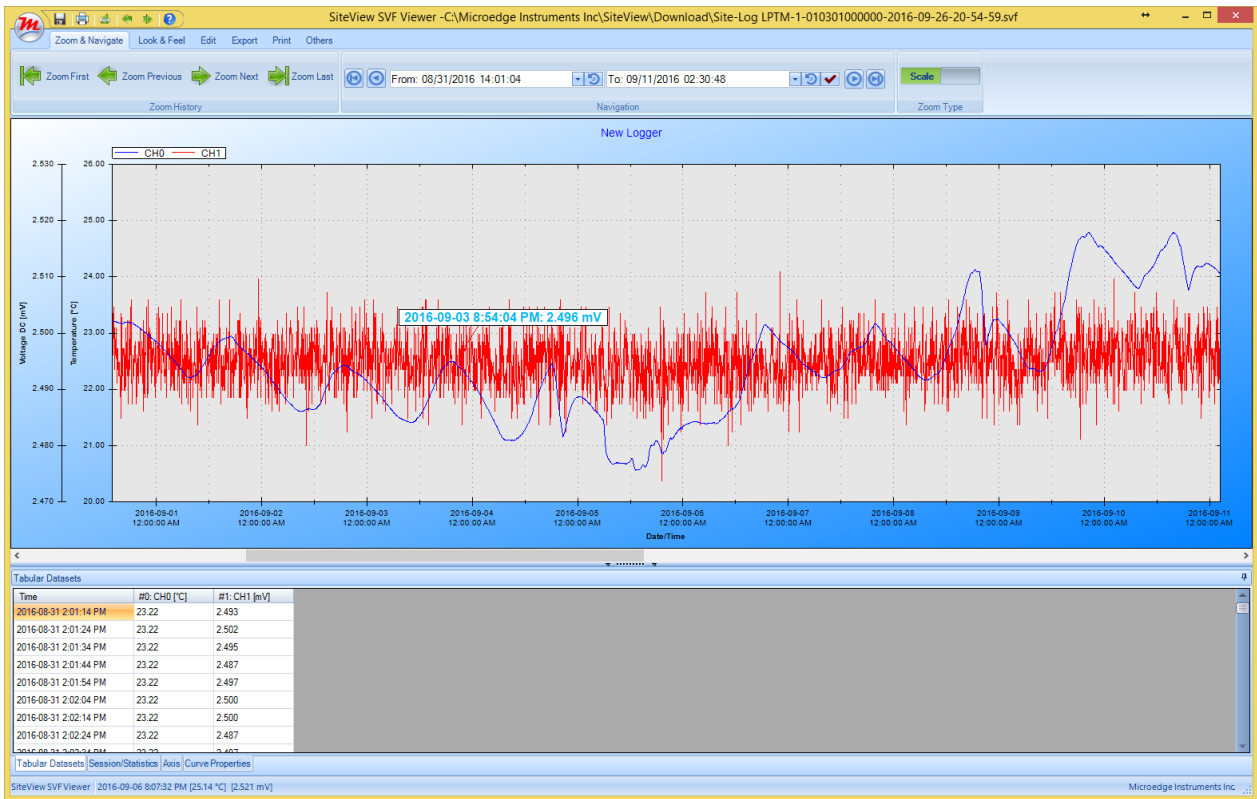

Real-Time Display

SiteView can view the real-time measurements while the logger is still logging data. The real-time display shows the list of the latest channel real-time measurements, as well as the trend chart of all channel real-time measurements for the past given period of time from the current time.

To open real-time view, if the logger has been contacted and the status of the logger is displayed, click on **Real-Time** tool bar button. The following real-time dialog appears:

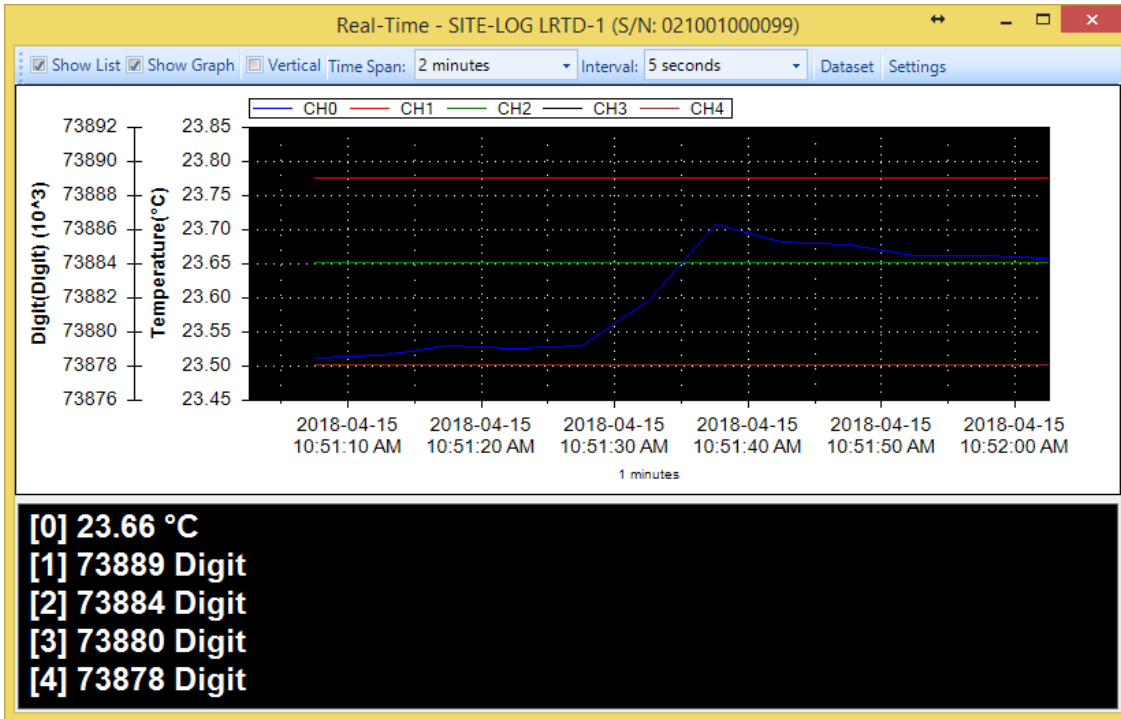

Real-Time in Horizontal View

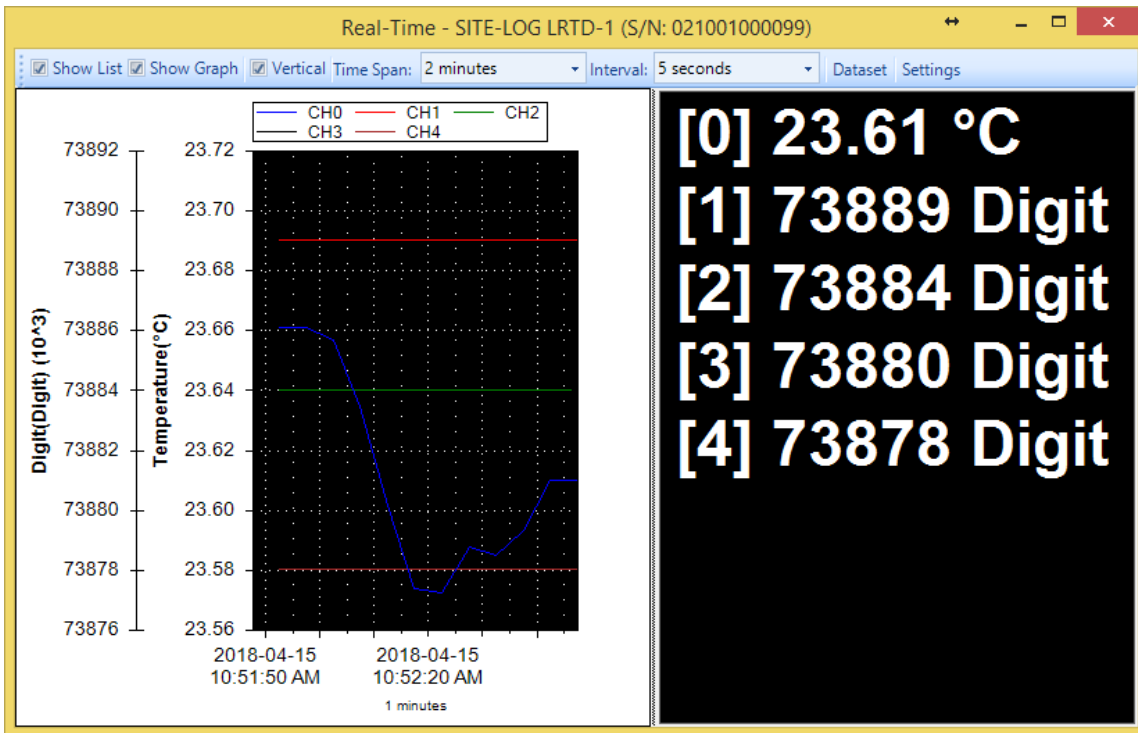

Real-Time In Vertical View

Tool bar buttons:

Show List

Click to show/hide the list view panel.

Show Graph

Click to show/hide the chart view panel.

Vertical

Click to display the chart and list views vertically.

Time Span

This field allows changing the time span for the chart view. Available settings are:

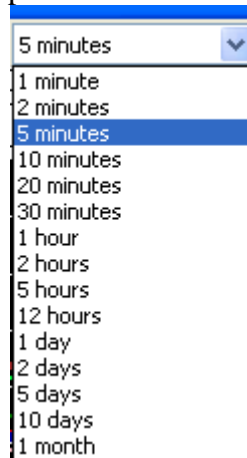

Dataset

Click to display the tabular view of the recorded measurements illustrated below:

| Dataset | | | | | | | | |
|-----------------------|----------|----------|----------|----------|----------|----------|----------|----------|
| Time | CH1 (°C) | CH2 (mV) | CH3 (mV) | CH4 (mV) | CH5 (mV) | CH6 (mV) | CH7 (mV) | CH8 (mV) |
| 21/08/2010 9:57:45 PM | 23.94 | 76.9055 | 76.9055 | 76.9055 | 76.9055 | 77.2107 | 77.2107 | 77.5158 |
| 21/08/2010 9:57:50 PM | 23.93 | 76.2951 | 76.6003 | 76.2951 | 76.6003 | 76.6003 | 76.9055 | 76.9055 |
| 21/08/2010 9:57:55 PM | 23.91 | 76.6003 | 76.6003 | 76.6003 | 76.6003 | 76.9055 | 77.5158 | 76.9055 |
| 21/08/2010 9:58:00 PM | 23.90 | 76.6003 | 76.9055 | 76.2951 | 77.2107 | 77.2107 | 77.2107 | 77.2107 |
| 21/08/2010 9:58:05 PM | 23.91 | 76.6003 | 76.6003 | 76.9055 | 77.2107 | 76.6003 | 75.9899 | 76.2951 |
| 21/08/2010 9:58:10 PM | 23.92 | 76.9055 | 76.9055 | 77.2107 | 76.6003 | 76.9055 | 76.6003 | 76.9055 |
| 21/08/2010 9:58:15 PM | 23.94 | 76.6003 | 76.2951 | 77.2107 | 77.2107 | 76.9055 | 76.6003 | 76.9055 |
| 21/08/2010 9:58:20 PM | 23.93 | 77.2107 | 76.2951 | 76.2951 | 76.9055 | 76.9055 | 77.2107 | 77.2107 |
| 21/08/2010 9:58:25 PM | 23.94 | 76.6003 | 76.2951 | 76.6003 | 77.2107 | 76.9055 | 76.9055 | 76.2951 |
| 21/08/2010 9:58:30 PM | 23.94 | 76.2951 | 76.6003 | 76.9055 | 77.2107 | 77.5158 | 76.9055 | 77.2107 |
| 21/08/2010 9:58:35 PM | 23.94 | 76.6003 | 76.2951 | 76.9055 | 76.9055 | 76.9055 | 76.6003 | 76.9055 |

Settings

Click to display more properties illustrated below:

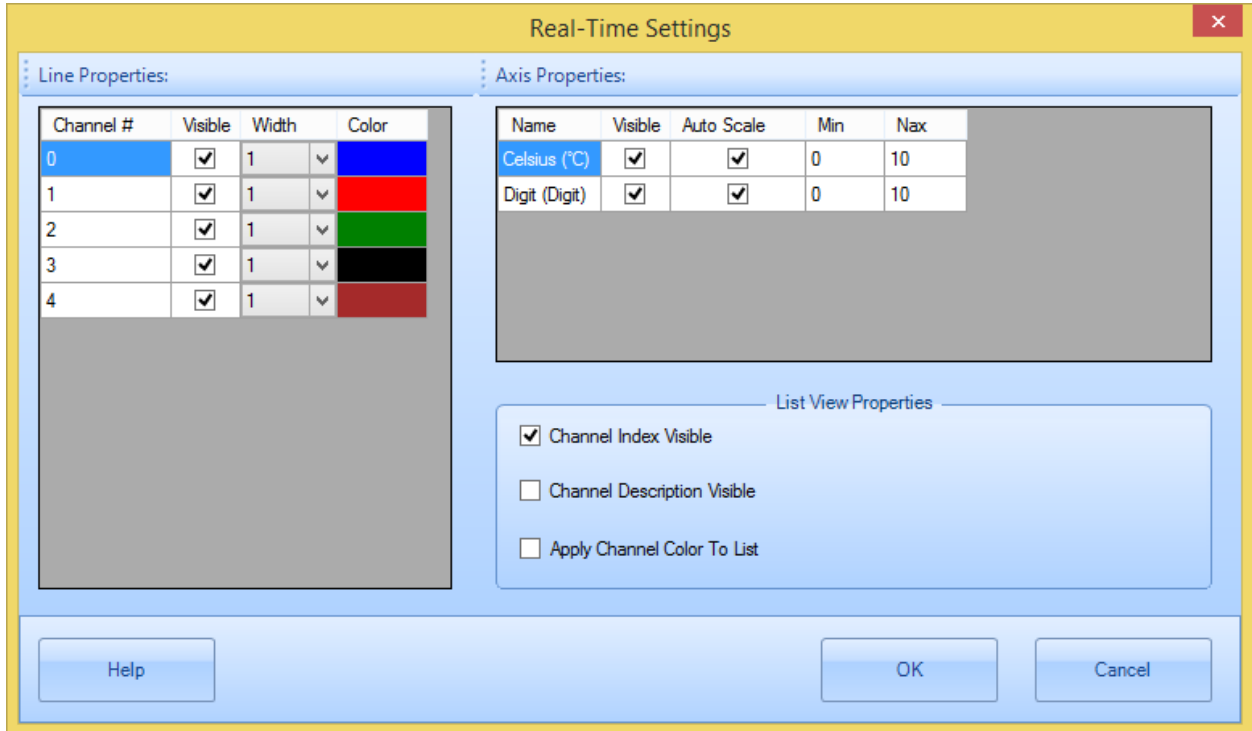

For detailed instructions on how to change real-time view settings please refer to **SiteView Instruction Manual** available for download online.

Calibrate a Channel

SiteView software provides two-point calibration for most of the loggers.

Understand Cali. Low & Cali. High

In the logger status page, there are two properties for each listed channel called **Cali. Low** and **Cali. High**. These two fields specify the calibration values that are used for measurement adjustment.

Cali. Low value specifies the digital value that is over zero when the input value is the lowest value (for 0 – 5 VDC channel the lowest value is zero volt). For instance, if you apply zero volt input and the logger measured 100 as the digital value, then **Cali. Low** should be 100 digits. The equation entity will subtract this value when resolving the correct lowest digital value.

Cali. High value specifies the digital value that is over 65535 when the input value is the highest value (for 0 – 5VDC channel the high range is 5 volt). For instance, if you apply 5 volt voltage to the channel and the logger measured 65100 as the digital value. Then **Cali. High** is “- 435” (calculated from 65100 – 65535). The equation entity will subtract this value (-435) from the digital value when resolving the highest digital value.

The valid range for these two parameters is from -32768 to 32767 .

The following figure illustrates the relationship between an ideal data line and a measured data line and how **Cali. Low** and **Cali. High** correct the measured data line.

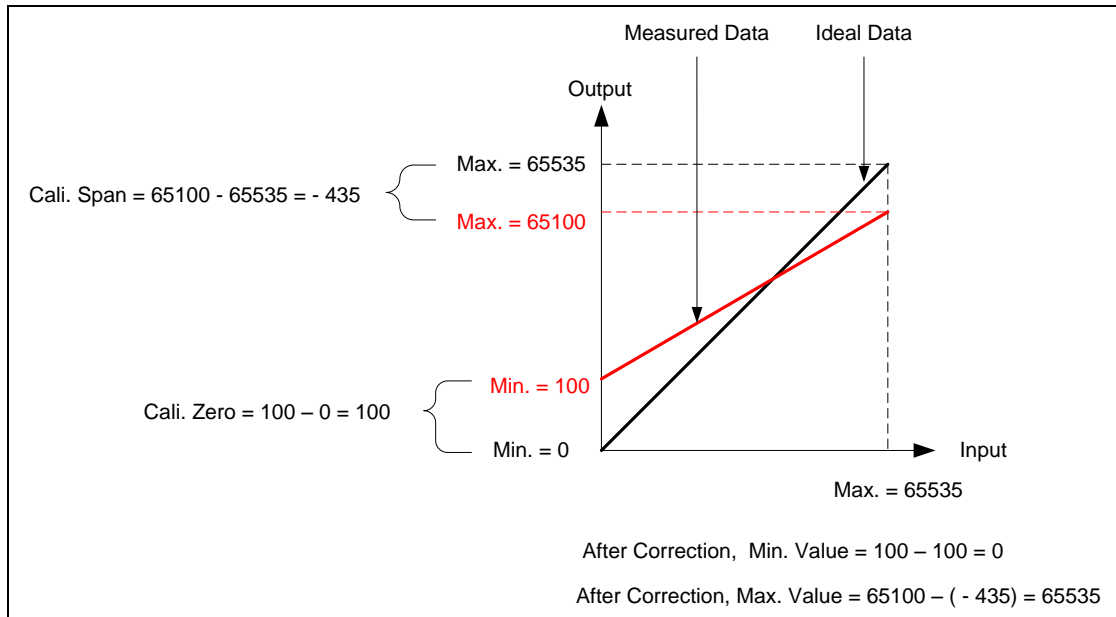

Decide On-Line or Off-Line Calibration

If the source signal like voltage or current can be connected to the logger while the logger is connecting to the computer, you can calibrate the logger on-line. If the source signal like a temperature or relative humidity is not available for on-line calibration, you can calibrate the logger off-line after the logger has recorded the low and high point data.

You access On-Line / Off-Line Calibration via Calibrate button on the logger status tool bar.

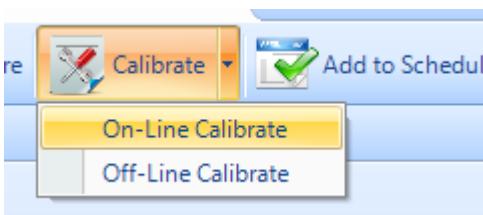

The following dialog appears:

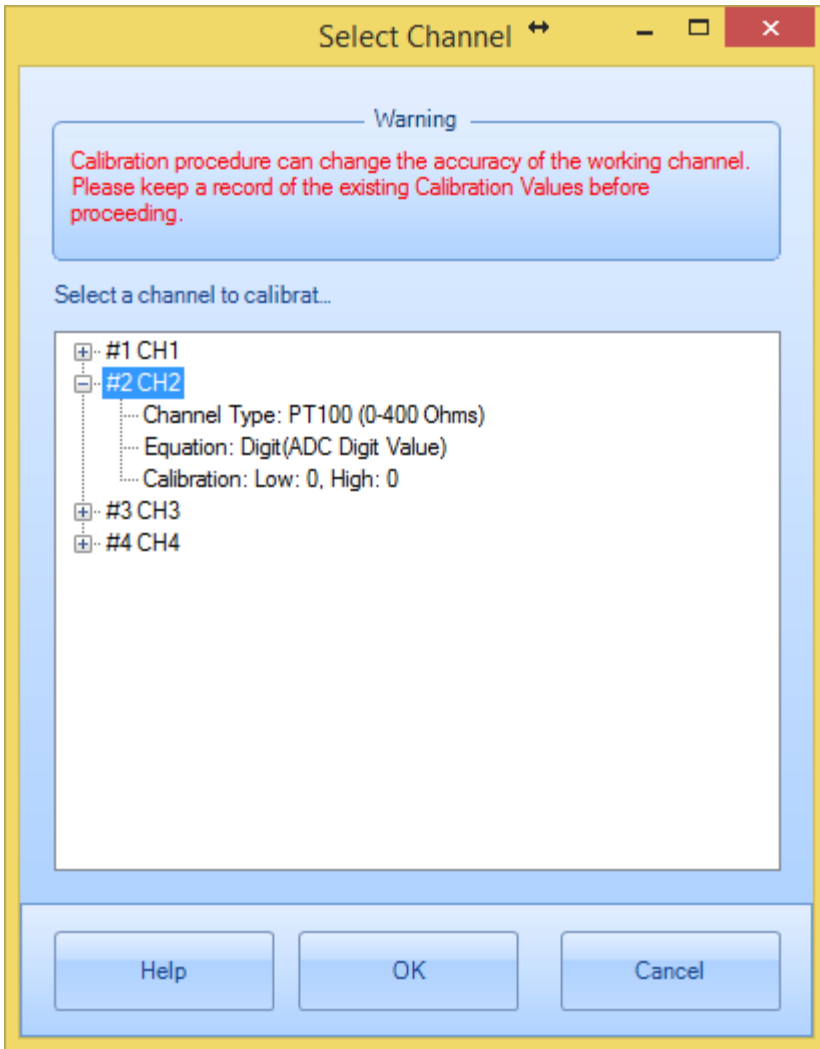

Select the channel you want to calibrate on and click **OK** button. The calibration dialogs appear as follows:

Channel Calibration Wizard - Channel:1



Step 1: Low Point Calibration

Based on the equation the channel is using, the range of the channel is:

MilliVolt(mV) To MilliVolt(mV)

Please type in the low point value of the source input that is connected to the channel:

Input Low Reference Value

MilliVolt(mV)

Click "Start Calibration" button to start the calibration. When you see the current reading is stable you can click "Stop Calibration" button to stop this procedure. (Minimum 3 readings)

 Current Reading MilliVolt(mV)

Click "Next >>" button to proceed for High Point Calibration.

Timer: 00:00:16 seconds. 3 readings

Channel Calibration Wizard - Channel:1



Step 2: High Point Calibration

Based on the equation the channel is using, the input range of the channel is:

MilliVolt(mV) To MilliVolt(mV)

Please type in the high point value of the source input that is connected to the channel:

Input High Reference Value

MilliVolt(mV)

Click "Start Calibration" button to start the calibration. When you see the current reading is stable you can click "Stop Calibration" button to stop this procedure. (Minimum 3 readings)

 Current Reading MilliVolt(mV)

Click "Next >>" button to proceed for the result.

Timer: 00:00:16 seconds. 3 readings

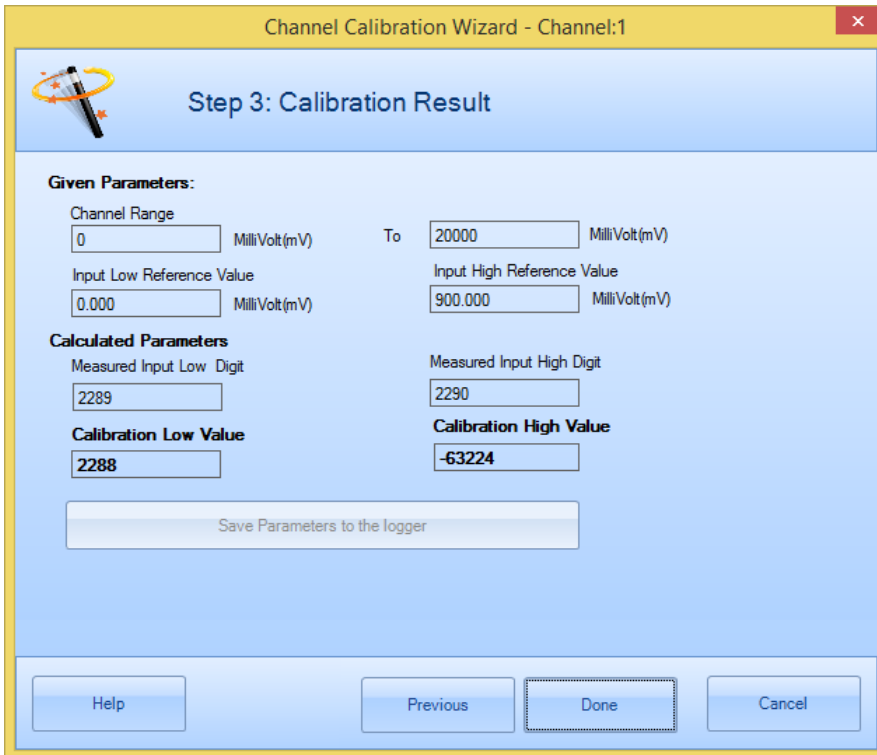

The above dialogs are for On-Line Calibration.

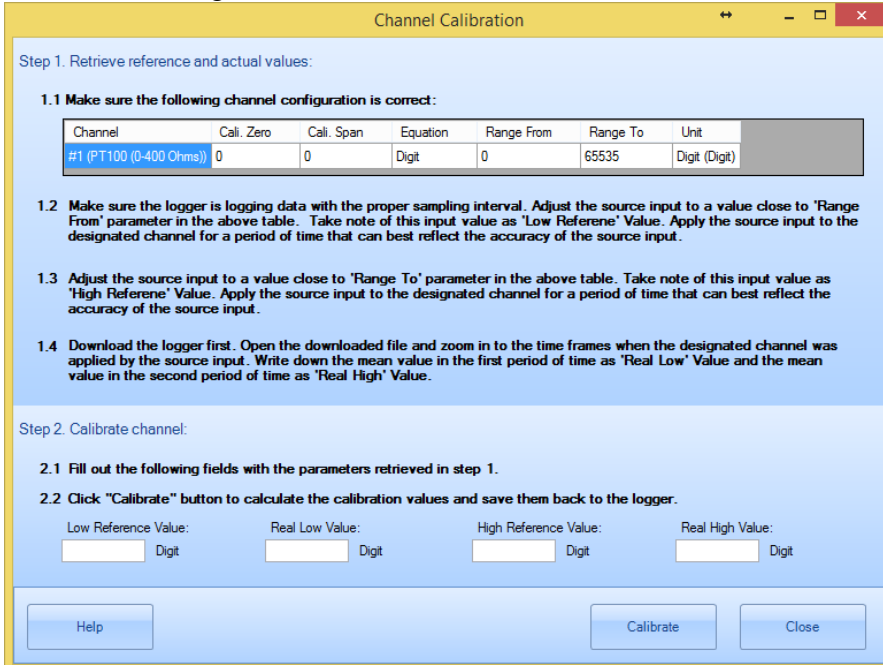

The above dialog is for Off-Line Calibration.

Please refer to **Calibrate Logger** chapter in **SiteView User's Manual** for details.

Communicate with PRECISE-LOG Wirelessly

In Standard Server Mode:

Once you have configured the logger with correct WIFI properties, the logger will register with the WIFI network. An IP address can be found in the logger's status window:

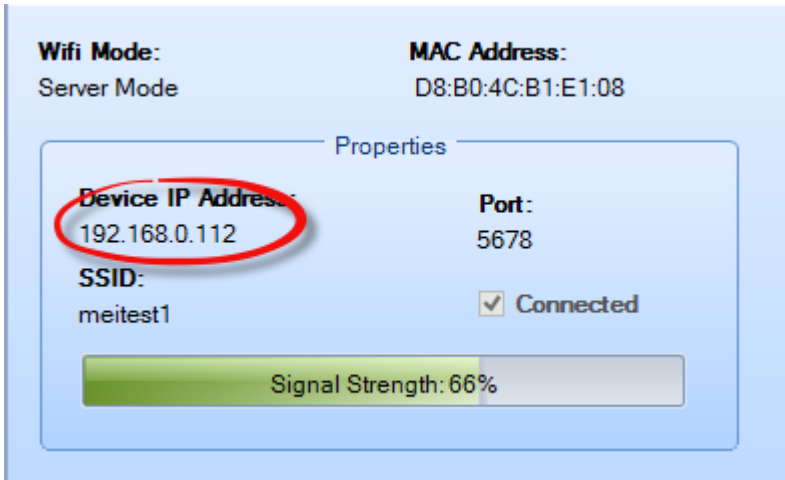

To add the logger to the USB Device Server tab, click “Add” button under USB Server tab to add a new connection:

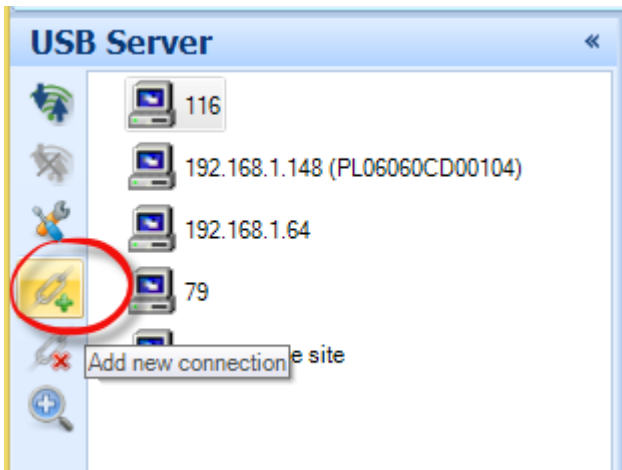

In the pop-up window, fill out the information. Make sure to enter the right IP address.

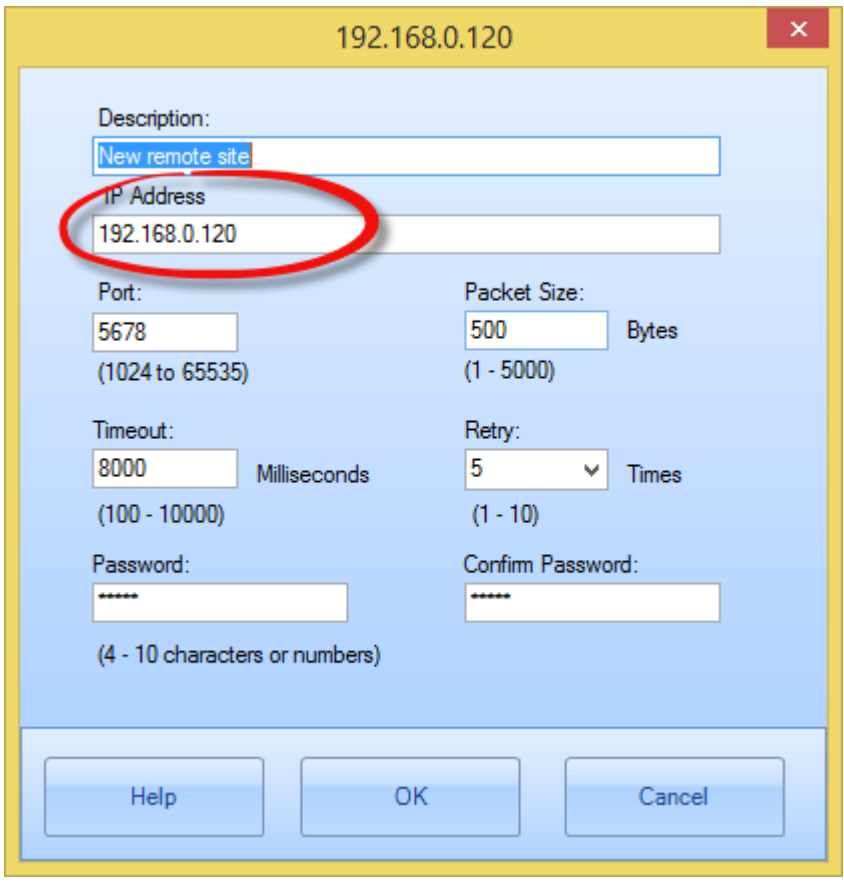

Then click “OK” button to save the connection.

Then double click the new added connection to open it. Upon the success, the logger icon will be added under this connection. Double click the logger icon to show the status window:

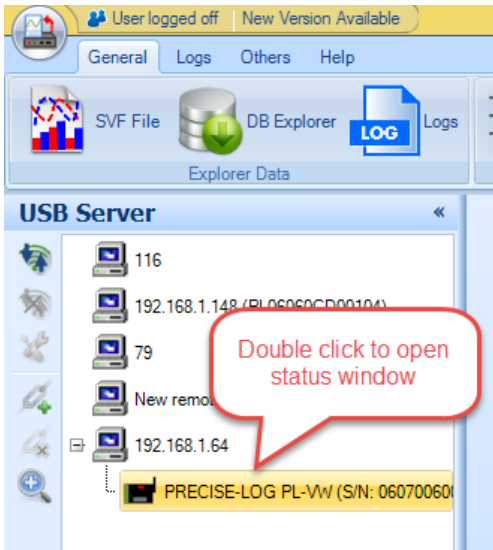

In AccessPoint Server Mode:

In this mode, the data logger will create a WIFI AP.

From the client computer, open the wifi network list to look for an access point named 'PL' + 'Serial Number of the logger'.

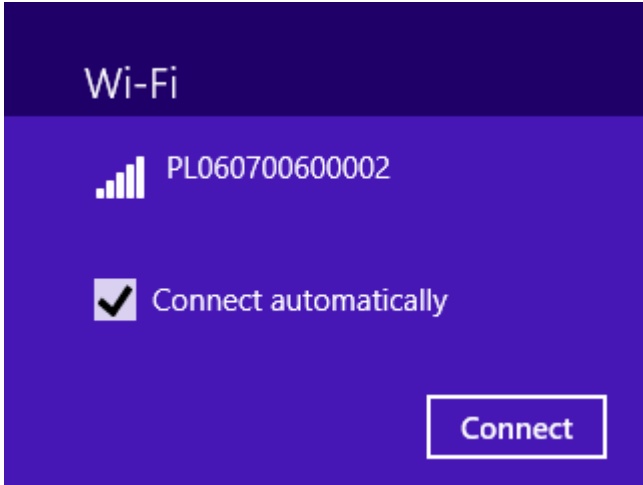

Click the access point and choose 'Connect'. Type in the password you set in 'AP Password field' when you configure the logger. Wait until you joined the network.

Inside SiteView, go to 'USB Server' panel:

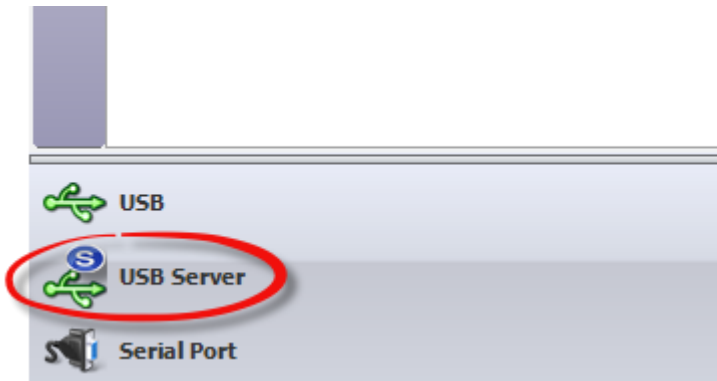

Click 'Create New' icon to create an AP connection.

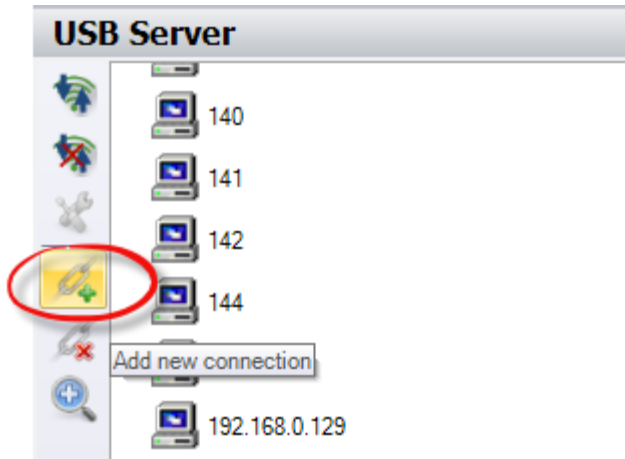

In the pup-up dialog, fill in the IP address field with '10.10.100.254' and give a name of this connection. Then click OK button to create the connection.

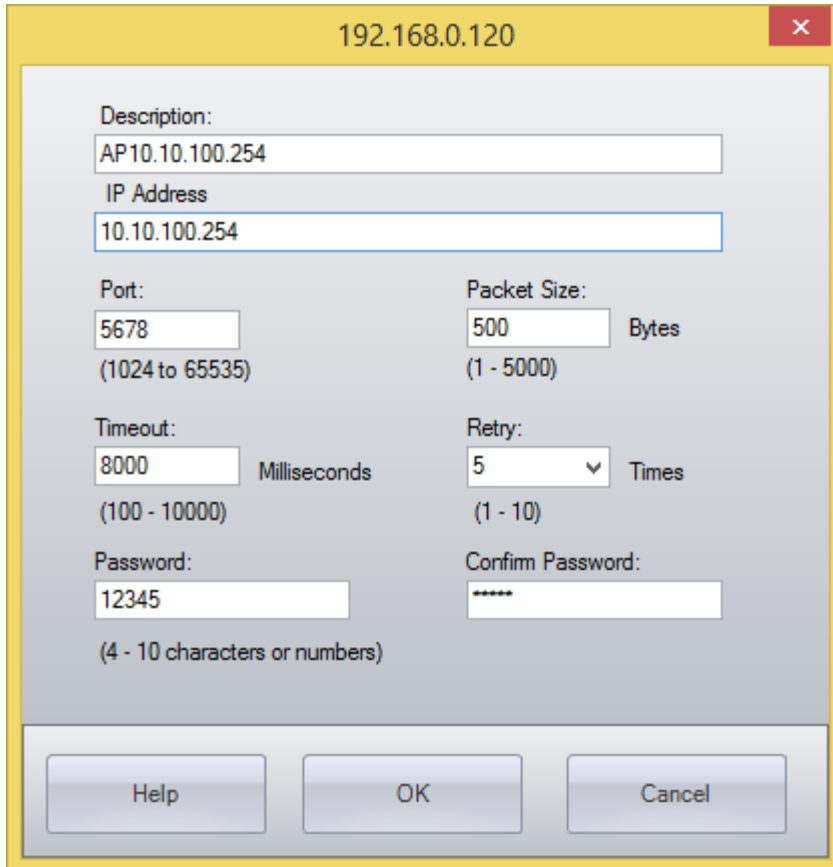

Double click on the new created icon to start communicate with the data logger.
If everything is fine, you should see the logger icon shows under the new created connection.



Double click the logger icon to show the logger status window.

6. Specifications

Common Specifications

| | |
|-----------------------------------|---|
| Alarm | |
| Channel Alarms | Two editable alarm thresholds per channel. |
| Alarm Indicator | On-board LED lights in red when in alarm state. |
| On-board Memory | |
| Capacity | 8 Mega-bytes (4 Mega measurements) |
| Data Retention | Over 20 years |
| Sampling & Logging | |
| Sampling Interval | 1 second to 12 user selectable. |
| Logging Mode | Stop recording or FIFO when memory is full. |
| Logging Activation | Programmable instant, start delay or field push button activation. |
| Communications | |
| Interface | USB (Mini-USB-B) (USB-A-mini USB-B Cable included) WIFI module for W series |
| Baud Rate | 115200 bps |
| Battery | |
| Power | Built-in 3.6V Lithium Battery. |
| Life Cycle | 10 years based on 1 minute sampling interval in stand-alone mode. |
| Software | |
| SiteView ^[1] | Configuration, downloading, scheduled downloading, plotting, real-time plotting, custom calibration and custom equation |
| Software Requirements | Computer with 1.0 GHZ or faster processor 1.0 GB Memory or higher 1.0 GB of available hard-drive space or higher Windows XP with SP2 or later, Vista, Window 7 At least one USB port. |
| WIFI Module ^[2] | |
| Standard | 802.11b/g/n, |
| Frequency Range | 2.412 – 2.484GHz |
| Transmit Power | 11-18 dBm |
| Receive Sensitivity | -82 to -93 dBm |
| Security | WEP/WPA-PSK/WPA2-PSK |
| Encryption | WEP64/WEP128/TKIP/AES |

| Physical | |
|-----------------------|--|
| Material | Aluminum Enclosure. |
| PCB Treatment | Conformal coating |
| Dimension | 88 X 64.2 X 24 mm 3.46 X 2.53 X 0.95 Inches |
| Weight | 200g |
| Mounting | Probe/wall-mount holes for hanging/mounting. |
| Others | |
| LED Indicator | Tri-Color LED: (can be disabled for power saving) Normal Sampling: green when sampling. Alarm: red when sampling. Low Battery: amber when sampling. |
| Operating Environment | -40 ~ +70°C (-40 to + 158°F), 0 ~ 95 %RH non-condensing. |
| Clock Accuracy | +/- 1 minute per month |
| Approvals | CE, FCC |

[1]: Sold separately.

[2]: Must be powered by external 5VDC power supply via Mini-USB Port.

Logging Capacity

| Sampling Interval | Enabled Channel | Logging Capacity |
|-------------------|-----------------|------------------|
| 1 minute | 1 | 8 years |
| 1 minute | 2 | 4 years |
| 1 minute | 8 | 1 year |
| 10 seconds | 1 | 485 days |
| 10 seconds | 2 | 242 days |
| 10 seconds | 8 | 60 days |

| Sampling Interval | Enabled Channel | Logging Capacity |
|-------------------|-----------------|------------------|
| 1 second | 1 | 48 days |
| 1 second | 2 | 24 days |
| 1 second | 8 | 6 days |
| | | |
| | | |
| | | |