

This instruction manual is a general guidance for all types of our Industrial-grade GS2 devices. Some features which are marked with asterisk are available for specific versions. Please refer to related instructions according to the version you purchased.

## PACKAGE LIST

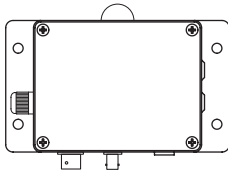

① Device

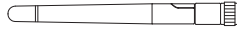

② External antenna ①

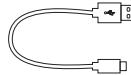

③ Type-C USB cable ②



④ Screwdriver



⑤ Information card

① Note: Please tighten the antenna before use.

② Please note that only the **4-wire** cable that we have provided with our product can support efficient data transmission. Some other cables may not work properly when connecting the PC Tools.

## INTRODUCTION

### 1. Appearance Introduction

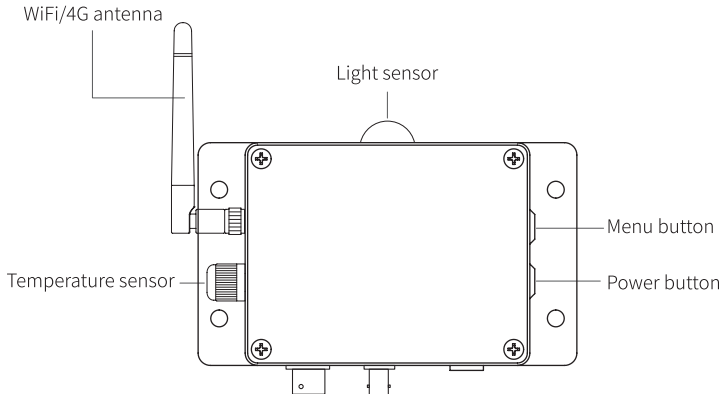

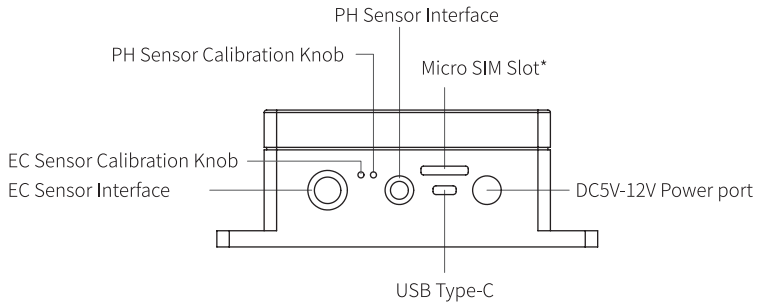

## 2. Screen Icons Introduction

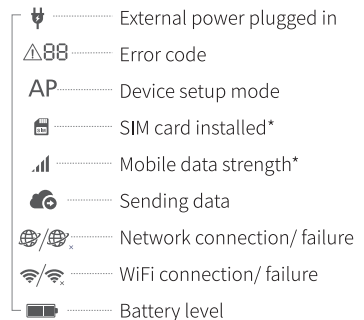
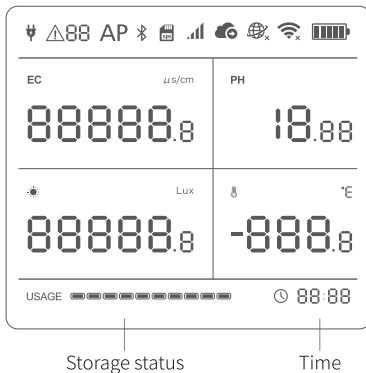

## 3. Device Operations

### Switch On

Press and hold the power button for 3 seconds until the screen lights up. Release the button and the device is now on.

## Switch Off

Press and hold the power button for 3 seconds until the screen is off. The device is now off.

## Device Setup Mode

With the device switched on, press and hold the menu button for 3 seconds. Once the AP icon starts flashing on the screen, release the button.

## Manual Data Synchronization

With the device switched on, press the power button once to trigger a manual data sync. The  icon will flash while the data is being transferred. You can also hear the voice guidance.

## Update Readings

Press the menu button once, the device reading will be updated to real-time data.

## Switch On/Off Voice Guide

Double press the menu button to enable or disable the voice guide. This will also refresh the last sensing data.

## Toggle Celsius or Fahrenheit

Double press the power button to toggle between displaying Celsius or Fahrenheit. This will also refresh the last sensing data.

## Display Backlight

Pressing either the menu button or the power button will switch on the display backlight for a short time. Pressing both of the two buttons at the same time will keep the backlight alight constantly. Pressing both buttons again will switch off the backlight.

## Conductivity Measurement

Place the conductance electrode and the temperature probe in the solution to be measured, and make sure they are close to each other. Take the readings from both instruments at the same time. Let the instruments rest in the solution for 5 minutes, and then press the device menu button to refresh the measured data.

## PH Value Measurement

Place the PH electrode and the temperature probe in the solution to be measured, and make sure they are close to each other. Let them rest in the solution for 5 minutes, and then press the device menu button to refresh the measured data.

## Reset to Default Settings

Switch the device off, then press and hold the menu button and the power button together for at least 8 seconds. Release the buttons when you hear the voice guidance: “The device will now reset.”



ALL STORED DATA WILL BE LOST IF YOU RESET YOUR DEVICE TO DEFAULT SETTINGS!  
REMEMBER TO SYNCHRONISE THE SENSING DATA TO THE UbiBot® IoT PLATFORM OR EXPORT THE DATA TO YOUR COMPUTER BEFORE RESETTING IT.

※ **Note: If the conductivity electrode and the PH electrode are placed in the same liquid at the same time for measurement, it is recommended to set the acquisition period to 5 minutes or above to ensure accurate determination of measured values.**

## CALIBRATION INSTRUCTIONS

### 1. Online Web-Console Calibration

Once the device has been registered, please log in to the web-console at

<http://console.ubibot.com/login.html> and follow the conductivity and PH calibration instructions.

### 2. PC tool calibration

Please download the UbiBot PC Tool, connect the device, and follow the instructions to calibrate the conductivity and PH values.

### 3. Offline Calibration

If the device operation environment has limited access to the network, you can also use offline calibration by following the instructions below.

#### • Conductivity Offline Calibration

- ① Pour the appropriate amount of the conductivity calibration solution into the container.
- ② Wash the conductance electrode with distilled water and wipe it clean to ensure that there is no dirt or other attachments on the surface of the electrode.
- ③ Put the conductance electrode and the temperature probe into the calibration solution, and let them rest in the solution for 5 minutes at room temperature. The optimal temperature of the calibration solution is 25°C

④ Press the menu button to refresh the measured data while turning the conductivity calibration knob until the value of the electrical conductivity displayed on the device is the same as the value of the calibration solution.

※ **The conductivity value of the calibration solution should be as close as possible to the conductivity value of the measured solution.**

※ **Turn the knob clockwise to increase conductivity, and turn the knob counterclockwise to decrease conductivity.**

※ **If you are not sure about the conductivity of the target solution, you can put the probe into the solution and take the measurement so you can make an assessment before calibration.**

#### • PH Offline Calibration

① Pour an appropriate amount of the calibration solution with PH=6.86 into the container.

② Rinse the PH electrode with distilled water and wipe it clean to ensure that there is no dirt or other attachments on the surface of the electrode.

③ Put the PH electrode and the temperature probe into the calibration solution and let them rest in the solution for 5 minutes at room temperature. The optimal temperature of the calibration solution is 25°C.

④ Press the menu button to refresh the measured data while turning the conductivity calibration knob until the value of the electrical conductivity displayed on the device is the same as the value of the calibration solution.

⑤ Rinse the electrodes with distilled water and wipe them clean for preservation.

※ **Turn the knob clockwise to increase conductivity, and turn the knob counterclockwise to decrease conductivity.**

※ **Online platform calibration is more helpful for improving the accuracy of PH value measurement than the offline calibration method.**

## APP INSTALLATION

### Option 1: Using Mobile App

Download the App from <http://www.ubibot.com/setup/>

You can also search for “UbiBot” on the App Store or Google Play.

**!** We recommend that you try to use the PC Tools when the App setup fails, because the failure may be due to mobile phone compatibility. The PC Tools is much easier to operate and more suitable for both Mac and Windows.

### Option 2: Using PC Tools

Download the tool from <http://www.ubibot.com/setup/>

This Tool is a desktop app for device setup. It is also helpful for checking setup failure reasons, the MAC address, and offline charts. You can also use it to export offline data stored in the device internal memory.

## DEVICE SETUP USING THE APP FOR WIFI CONNECTION

Launch the App and log in. On the home page of the App, tap "+" to start adding your device, and then follow the in-app instructions to complete the setup. You can also view the demonstration video at <http://www.ubibot.com/setup/> for step-by-step guidance.

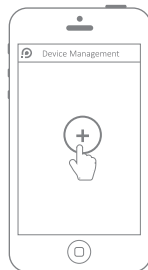

Add your device

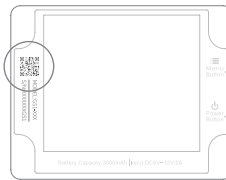

Scan the QR code

Via our app and web console (<http://console.ubibot.com>), you are able to view the sensor readings as well as configure your device, including creating alert rules, setting the data sync interval, etc. You can find and watch the demonstration videos at <http://www.ubibot.com/setup/>.

## DEVICE SETUP USING THE APP FOR MOBILE NETWORK \*

Before you set up the device on mobile data, please check the APN information of the SIM card used for the UbiBot device.

An APN (Access Point Name) provides the details your device needs to connect to mobile data through your network operator. APN details differ by network and you will need to get these from your network operator.

With the device off, insert the SIM card as indicated in the picture below. Launch the app and log in. Tap "+" to start setting up the device. Please follow the in-app instructions to complete the setup process. Please note, the setup will fail if you don't have sufficient data allowance.

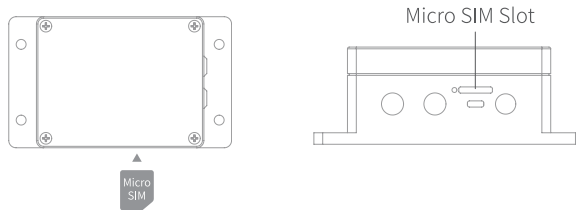

## DEVICE SETUP USING PC TOOLS

### STEP1.

Launch the App and log in. With the device switched on, use the Type-C USB cable provided with your device to connect your device to the computer. The Tools will automatically scan your device and enter the device page.

### STEP2.

Click "Network" on the left menu bar. There you will be able to set up the device on WiFi or mobile data.

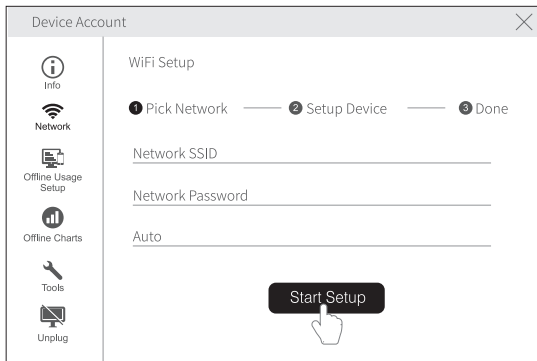

## TECHNICAL SPECIFICATIONS

WiFi, 2.4GHz, channels 1-13

Built-in 2900mAh lithium battery

152mmx90mmx55mm

Supports Micro SIM card\* (15mm x 12mm x 0.8mm)

Flame resistant ABS + PC

Type-C, DC5V/2A or 12V/1A power supply

Built-in Memory:300,000 sensing data

Optimal working conditions: -20°C to 60°C, 10% to 90%RH(No condensation)

※Note: The operating temperature range of the PH value electrode is 5–60°C

## ERROR CODES

### 01 System Protection

Please follow the instructions to properly configure the device. Unconfigured devices will revert to the system protection mode to save power.

### 02 WiFi Connection Failed

Please refer to the Troubleshooting section 3.



### 03 Failed to Connect to Server

Please refer to the Common Questions at <http://www.ubibot.com/category/faqs/>

### 04 Device Activation Failed

Please refer to the Troubleshooting section 1.

### 05 Data Save Failure

This can happen when there is a power disruption while saving data when the power is disrupted while data is being saved.

### 06 Incorrect Data Format

This can happen when there is a power disruption while saving data.

### 07 Data Sync Failed

Please refer to the Troubleshooting section 3.

### 08 No SIM Card Found

Please check if the SIM card is correctly inserted.

### 09 Mobile Data Network Failure

Please make sure your SIM card is set up correctly and has been activated.

## TROUBLESHOOTING

### 1. Device setup failure when using the UbiBot App.

There are several factors that can affect the setup process. The followings are common issues:

- ① WiFi frequency: The Device can only connect to 2.4GHz networks, channels 1–13.
- ② WiFi password: Go through the device setup again and ensure that you have set the correct WiFi password for the network.
- ③ WiFi security type: The Device supports OPEN, WEP, or WPA/WPA2 types.
- ④ WiFi channel width: Make sure it is set to 20MHz or "Auto".
- ⑤ Internet connection: Make sure your device's WiFi router has a working Internet connection (for instance, try to access [www.ubibot.com](http://www.ubibot.com) using your mobile phone connected to the same WiFi router).
- ⑥ Low battery power: WiFi uses a lot of power. Your device may be able to power on but may not have enough power for the WiFi. Please charge the device.
- ⑦ Signal strength: Make sure you have a good connection with WiFi, 3G/4G.
- ⑧ Please make sure the device has entered WiFi setup mode.

For direct problem diagnosis, please use the PC Offline Tools to go through the setup process and contact us with the response error code in Tools->Get Device Last Error. This can help us to conduct remote diagnosis.

## 2. Failure to sync data. Please check the following:

- ① With the device switched on, press the power button once to trigger a manual data sync. If the data has been successfully transferred, you will hear “sync completed.” If it says “sync failed”, try the next steps.
- ② Check if the device has sufficient battery power for data sync. Data synchronization consumes a lot of power -- the device may be on but unable to sync data. Please check the battery icon on the screen. Charge the device before it runs out of power.
- ③ Make sure your device's WiFi router has a working Internet connection (for instance, try to access www.ubibot.com using a mobile phone connected to the same WiFi).
- ④ If you are using mobile data, make sure your SIM card is activated. If activated, make sure the batteries and the USB power connection are able to provide 2A current. Check if your mobile data allowance is used up.

### 3. Can I use the device without a network connection? How do I access the data?

The device will continue working without a network connection and can store up to 300,000 readings in its memory. Real-time readings are displayed on screen and you can access the data in the following ways:

- ① Move the device to an area where there is a WiFi connection which the device can connect to. Press the power button once to manually trigger data sync. After the sync completes, it is recommended that you take the device back to the measurement location.
- ② Use your mobile phone and enable Internet Connection Sharing. This can work well when your devices are installed in an area with limited or no WiFi coverage.
- ③ Use a laptop and the Micro USB cable to connect to the device manually. You can now perform a data export to your computer using the PC Tools.
- ④ Set up the device with a mobile data card. Once you are in range of the network, press the power button once to sync all data to the IoT platform.

### 4. Can't enter the setup mode.

Please try to reboot the device and re-enter the setup mode. If it still fails, please use the external power supply to charge the device timely.

### 5. How often does the PH electrode or the conductance electrode need to be changed?

In general, the PH electrode and the conductance electrode need to be replaced in time if there is a large deviation in the measured value after calibration. The conductance electrode has a long lifespan of several years, while the PH electrode generally needs to be replaced once a year. The specific service life depends on actual use.

## 6. How often does the PH electrode or the conductance electrode need to be calibrated?







PH value electrode: In the case of high accuracy requirements, it is recommended to conduct calibration each time before use; if there is no strict accuracy requirement, it can be calibrated according to the actual situation.

Conductance electrode: Normally, it is recommended to calibrate once a month. If there is no strict accuracy requirement, it can be calibrated according to the actual situation.

## 7. When measuring pure water or liquids with very low ion concentration, the measurement data will be unstable.

This is because the ion concentration in the liquid to be measured is very low, and the high concentration of KCl in the salt bridge solution of the reference electrode has a large concentration difference with each other, which is very different from its situation in ordinary solution. Pure water will increase the permeation rate of the salt bridge solution, prompting the loss of the salt bridge, thus accelerating the reduction of the concentration of K<sup>+</sup> and Cl<sup>-</sup>. If the concentration of Cl<sup>-</sup> changes, the potential of the reference electrode itself will also change and the drift of the measured value will occur. Special electrodes are required for measuring pure water or liquids with very low sub-concentration.

## PRODUCT CARE

-  Please always follow the instructions contained in this manual.
-  The device is not waterproof. Please keep away from water during operation, storage and shipping.
-  Always mount the device on a stable surface.
-  Keep away from acidic, oxidizing, flammable or explosive substances.
-  When handling the device, avoid using excessive force and never use sharp instruments to try and open it.
-  The optimal working environment of the device: temperature -20–60°C, humidity 10-90% RH (No condensation); PH electrode operating temperature range of 5–60°C
-  Suggestions for disposal: The disposal of the device and its packaging should be handled according to the relevant urban environmental protection regulations.

## TECHNICAL SUPPORT

The UbiBot team is glad to hear your voice on our products and services.

For any questions or suggestions, please feel free to create a ticket in the UbiBot app. Our customer service representatives respond within 24 hours and often in less than an hour. You can also contact the local distributors in your country for localized service. Please go to our website to view their contact info.

## WARRANTY INFORMATION

1. This device is warranted to be free of defects in materials and workmanship for a period of up to one year from the original purchase date. This warranty does not cover damage caused by normal wear, misuse, abuse or incorrect repair. To make claims under this limited warranty and to obtain warranty service, please contact our customer service or local distributor to obtain instructions on how to pack and ship the product back to us.

2. The following situations will not be covered by the warranty:

- ① Issues arising after the warranty period has ended. Natural wear and aging of materials.
- ② Malfunction or damage caused by improper handling or not operating the device according to the instructions.
- ③ Damage occurring from operating the device outside the recommended temperature and humidity range, damage from contact with water (including uncontrolled water intrusion, e.g., water vapour and other water-related causes), damage from applying excessive force to the device or any cables and connectors.
- ④ Failure or damage caused by unauthorized removal of the product.
- ⑤ We can only be held liable for faults stemming from manufacturing or design. We are not responsible for any damage caused by force majeure.