



Operation Manual

EE211

HEATED HUMIDITY / TEMPERATURE SENSOR

Distributed by IOThrifty
Website: IOThrifty.com
Email: service@iothrifty.com
Telephone: 1-860-733-1117

YOUR PARTNER IN SENSOR TECHNOLOGY



ELEKTRONIK[®]
Ges.m.b.H.

E+E Elektronik Ges.m.b.H. doesn't accept warranty and liability claims neither upon this publication nor in case of improper treatment of the described products.

The document may contain technical inaccuracies and typographical errors. The content will be revised on a regular basis. These changes will be implemented in later versions. The described products can be improved and changed at any time without prior notice.

© Copyright E+E Elektronik Ges.m.b.H. All rights reserved.

EMC note USA (FCC):

This equipment has been tested and found to comply with the limits for a Class A digital device, pursuant to part 15 of the FCC Rules. These limits are designed to provide reasonable protection against harmful interference when the equipment is operated in a commercial environment. This equipment generates, uses, and can radiate radio frequency energy and, if not installed and used in accordance with the instruction manual, may cause harmful interference to radio communications. Operation of this equipment in a residential area is likely to cause harmful interference in which case the user will be required to correct the interference at his own expense.

EMC note Canada (ICES-003):

CAN ICES-3 (A) / NMB-3 (A)

CONTENT

1	General	4
1.1	Explanation of Symbols	4
1.1.1	General Safety Instructions	4
1.2	Environmental Aspects	4
1.2.1	Mounting and Start-up	5
2	Scope of Supply	5
2.1	Accessories	5
2.2	Spare Parts	5
3	Product Description	5
3.1	Operation Principle	5
3.2	Dimensions in mm (inch)	6
3.3	Connection Diagram	6
3.4	LED Indication	7
3.5	Display	7
3.6	Selection Output Signal Voltage / Current	7
3.6.1	Examples	7
4	Assembly and Installation	7
5	Setup	8
5.1	EE-PCS Product Configuration Software	8
5.2	Digital Interface RS485 with Modbus RTU Protocol	8
5.2.1	Hardware Bus Termination	8
5.2.2	Address Switch	9
5.2.3	Digital Settings	9
5.2.4	Modbus Register Map	9
5.2.5	Reading Example	11
6	Maintenance	12
6.1	Cleaning	12
6.2	Filter Replacement	12
6.3	Adjustment and Calibration	12
6.3.1	Definitions	12
6.4	RH and T Calibration / Adjustment	12
6.4.1	Adjustment Procedure	12
6.5	Individual Calibration / Adjustment of the T Probe	13
6.5.1	Adjustment Procedure	13
7	Technical Data	14

1 General

This operation manual serves for ensuring proper handling and optimal functioning of the device. The operation manual shall be read before commissioning the equipment and it shall be provided to all staff involved in transport, installation, operation, maintenance and repair.

The operation manual may not be used for the purposes of competition without the written consent of E+E Elektronik® and may not be forwarded to third parties. Copies may be made for internal purposes. All information, technical data and diagrams included in these instructions are based on the information available at the time of writing.

Intended use

The EE211 is intended for the measurement of relative humidity (RH) and temperature (T) in environment with continuous high humidity. The use of the EE211 other than described in this manual is not recommended.

The manufacturer cannot be held responsible for damages as a result of incorrect handling, installation and maintenance of the device. Unauthorized modifications of the product lead to loss of all warranty claims. The device may only be powered with separated extra-low voltage (SELV).

Disclaimer

The manufacturer or his authorized agent can be only be held liable in case of willful or gross negligence. In any case, the scope of liability is limited to the corresponding amount of the order issued to the manufacturer. The manufacturer assumes no liability for damages incurred due to failure to comply with the applicable regulations, operating instructions or the operating conditions. Consequential damages are excluded from the liability.

1.1 Explanation of Symbols



This symbol indicates safety information.

It is essential that all safety information is strictly observed. Failure to comply with this information can lead to personal injuries or damage to property. E+E Elektronik® assumes no liability if this happens.



This symbol indicates instructions.

The instructions shall be observed in order to reach optimal performance of the device.

1.1.1 General Safety Instructions

- The sensor and mainly the sensing head of the probes shall not be exposed to extreme mechanical stress.
- Installation, electrical connection, maintenance and commissioning shall be performed by qualified personnel only.
- Use the EE211 only as intended and observe all technical specs.
- Make sure that the T Probe is properly connected. The absence of the T probe forces the analogue outputs into the upper limitation.
- The sensor must be operated with the filter caps on at all times. Do not touch the sensors inside the sensing head.
- While replacing the filter cap (because of pollution for instance) against an original spare one please take very good care to not touch the sensors.

1.2 Environmental Aspects



Products from E+E Elektronik® are developed and manufactured observing of all relevant requirements with respect to environment protection. Please observe local regulations for the device disposal.



For disposal, the individual components of the device must be separated according to local recycling regulations. The electronics shall be disposed of correctly as electronics waste.

1.2.1 Mounting and Start-up

The device has been produced under state of the art manufacturing conditions, has been thoroughly tested and has left the factory fulfilling all safety criteria. The manufacturer has taken all precautions to ensure safe operation of the device. The user must ensure that the device is set up and installed in a manner that does not have a negative effect on its safe use.

The user is responsible for observing all applicable safety guidelines, local and international, with respect to safe installation and operation on the device. This operating manual contains information and warnings that must be observed by the user in order to ensure safe operation.

- Mounting, start-up, operation and maintenance of the device may be performed by qualified staff only. Such staff must be authorized by the plant operator to carry out the mentioned activities.
- The qualified staff must have read and understood this operating manual and must follow the instructions contained within.
- All process and electrical connections shall be thoroughly checked by authorized staff before putting the system into operation.
- Do not install or start start-up a device supposed to be faulty. Make sure that such devices are not accidentally used by marking them clearly as faulty.
- A faulty device may only be investigated and possibly repaired by qualified, trained and authorized staff. If the fault cannot be fixed, the device shall be removed from the system.
- Service operations other than described in this operating manual may only be performed by the manufacturer.

2 Scope of Supply

- EE211 according ordering guide
- Cable gland M20 x 1.5
- Mounting materials
- Test report according to DIN EN10204 - 3.1
- Quick User Guide

2.1 Accessories

- | | |
|--|---|
| • Product configuration software | EE-PCS (free download: www.epluse.com) |
| • Power supply adapter | V03 (see data sheet Accessories) |
| • Protection cap for 12 mm (0.47") probe | HA010783 |
| • USB configuration adapter | HA011066 |
| • Cable for T-probe (M12x1 socket, M12x1 plug) | |
| - 2 m (6.6 ft) | HA010801 |
| - 5 m (16.4 ft) | HA010802 |
| - 10 m (32.8 ft) | HA010803 |

2.2 Spare Parts

- | | |
|---------------------|------------------------------|
| • Filter cap | see data sheet „Accessories“ |
| • Temperature probe | EE07-MT |

3 Product Description

3.1 Operation Principle

The humidity probe is continuously heated for avoiding the effects of condensation and high humidity onto the sensing elements, such as corrosion, high humidity drift or stray impedances. Thus, the probe heating leads to outstanding long term stability. Based on the measured values humidity and temperature, the EE211 calculates the dew point temperature T_d whereas the separate, interchangeable T-probe measures the ambient temperature. Ultimately, out of T_d and T , the device calculates the relative humidity RH as well as several other parameters like absolute humidity, mixing ratio, wet bulb temperature or enthalpy.

Outstanding long term stability under high humidity conditions

The operation principle of EE211 copes with the causes for poor long-term stability of non-heated sensors at continuously high humidity. The constant over-temperature of the EE211 sensing head (approx. 5 °C = 9 °F) means max. 76 % RH humidity at the sensors and enables following benefits:

- The sensing head of EE211 stays dry even under condensing conditions, which prevents dust and dirt from sticking to the sensor and leads to outstanding long-term stability.
- The combination of dry sensing head, E+E proprietary coating of the sensing element and sealed solder pads minimize the impact of corrosive agents.
- Maximum humidity of 76 % RH at the sensor eliminates the drift caused by exposure to continuous high humidity.

3.2 Dimensions in mm (inch)

Basis Unit:

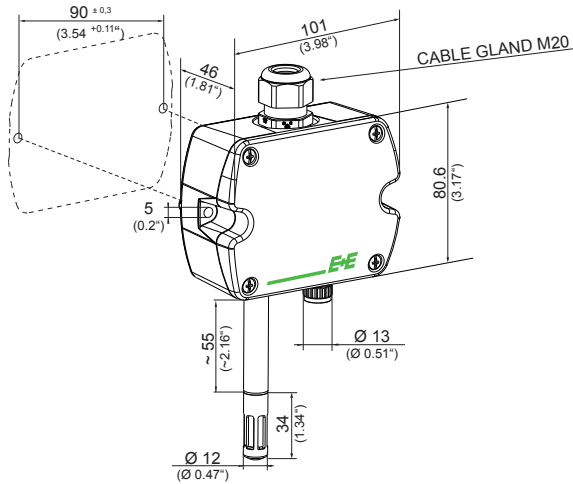

Temperature Probe:

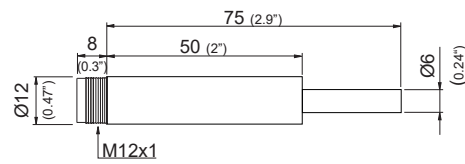
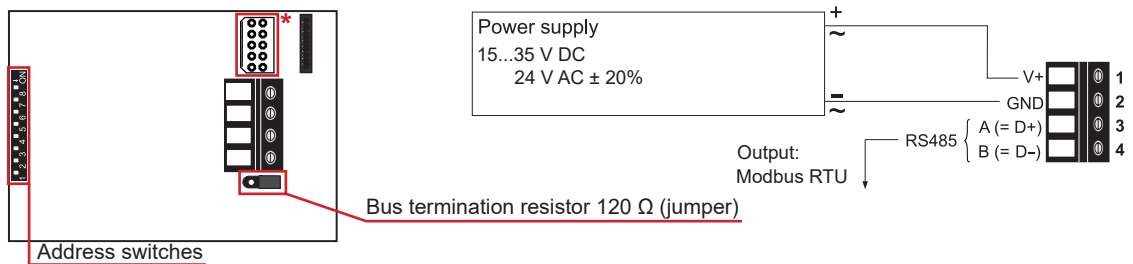

Fig. 1 Dimensions of basis unit and temperature probe

3.3 Connection Diagram

EE211-M1J3 - Digital Output



EE211-M1A2/3/5/6 - Analogue Output

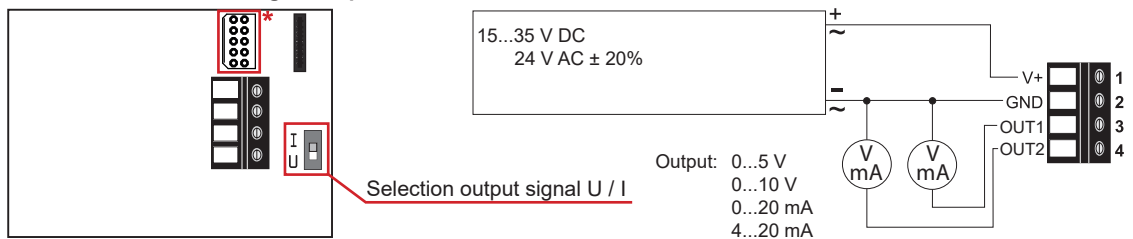

* Setup interface

Fig. 2 Connections and setup

3.4 LED Indication

Green LED

Information during normal operation

on	=	everything OK
flashing	=	the main board does not recognize the measurement electronics inside the RH probe
off	=	no power supply or main board failure

Blue LED

Information during setup with the optional USB configuration adapter HA011066 and the EE-PCS Product Configuration Software

on	=	USB stick connected to PC, no communication with EE-PCS
flashing	=	communication in progress with EE-PCS
off	=	USB stick not connected to PC

Tab. 1 LED Indication

3.5 Display

Factory Setup:

The display shows the two parameters selected for output 1 and output 2 (according to ordering code). For the Modbus version the display shows RH and T.

User Setup:

The user can change the display layout to 1, 2 or 3 lines and select the parameters to be displayed by using EE-PCS Product Configuration Software (free download from www.epluse.com/configurator) and the optional USB configuration adapter HA011066 (not included in the scope of supply).

3.6 Selection Output Signal Voltage / Current

The factory setup of the output signal and scaling corresponds to the type number as ordered. The output signal voltage (U) or current 3-wire (I) can be selected with the DIP switch on the main electronics board (see 3.3 Connection Diagram - EE211-M1A2/3/5/6). This does not impact on the scaling of the outputs, which can be changed using the EE-PCS Product Configuration Software and the optional USB configuration adapter HA011066.

3.6.1 Examples

Factory setup: voltage output 0-5 V or 0-10 V corresponds to 0...100% RH.

After switching from U to I: current output 4 ... 20 mA (3-wire) corresponds to 0 ... 100% RH. A change of the current output range for instance to 0-20 mA can be made subsequently with the EE-PCS Product Configuration Software and the optional USB Configuration Adapter HA011066.

Factory setup: current output 0-20 mA or 4-20 mA (3-wire) corresponds to -10...50 °C.

After switching from I to U: voltage output 0-10 V corresponds to -10...50 °C. A change of the voltage output range for instance to 0-5 V can be made subsequently with the EE-PCS Product Configuration Software and the optional USB configuration adapter HA011066.

4 Assembly and Installation

- Insert the M20 cable gland included in the scope of supply into the corresponding opening of the EE211 basis unit and fix it tight with the nut. Alternatively, it is possible to install a 1/2" conduit fitting (not included in the scope of supply).
- Install the EE07-MT temperature probe either directly onto the M12 connector of the EE211 basis unit or using the optional probe cable.

The entire EE211 shall be placed inside the space to be monitored. The measured RH correspond to the location of the T probe. Consequently, the T probe shall be positioned at the place of main interest for RH measurement. For instance, in an environmental chamber, the EE211 basic unit can be fixed conveniently on the inside wall, while the T probe can be placed in the middle of the chamber using the optional probe cable.

5 Setup

The EE211 is ready to use and does not require any configuration by the user. The factory setup of EE211 corresponds to the type number ordered. For ordering guide please see data sheet at www.epluse.com/ee211. If needed, the user can change the factory setup by using the USB configuration adapter (cod HA011066) and the EE-PCS, Product Configuration Software.

The user can change the scaling and the analogue output signal, the digital settings and perform RH and T adjustment.

Note: The EE211 may not be connected to any additional power supply when using the USB configuration adapter HA011066.

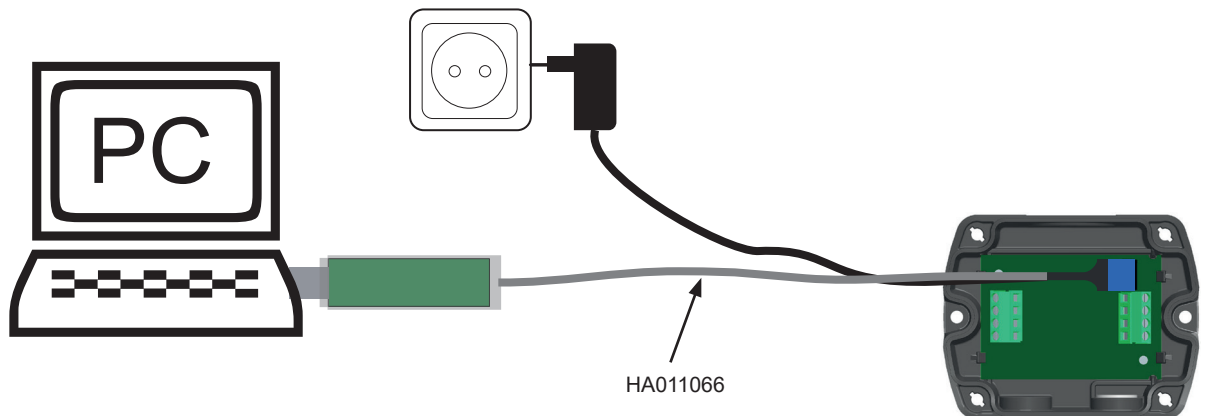

Fig. 3 Configuration adapter

5.1 EE-PCS Product Configuration Software

1. Download the EE-PCS Product Configuration Software from www.epluse.com/configurator and install it on the PC.
2. Connect the E+E device to the PC using the USB configuration cable.
3. Start the EE-PCS software.
4. Follow the instructions on the EE-PCS opening page for scanning the ports and identifying the connected device.
5. Click on the desired setup or adjustment mode from the main EE-PCS menu on the left and follow the online instructions of the EE-PCS

5.2 Digital Interface RS485 with Modbus RTU Protocol

5.2.1 Hardware Bus Termination

If required, the bus termination shall be realized with 120 Ohm resistor, jumper on the board.

- Jumper mounted = bus terminated
- Jumper not mounted = bus not terminated

5.2.2 Address Switch

Address Switch

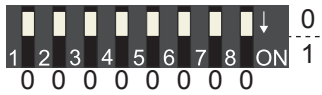

Address setting via EE-PCS Product Configuration Software

All DIP switches at position 0 → address has to be set via Product Configuration Software

Factory setting: 239 (permitted values: 1...247).

Example: Slave address is set via configuration software.

Address Switch



Address setting via DIP switch

Setting the DIP switches to any other address than 0, overrules the slave address set via configuration software (permitted values: 1...247).

Example: Slave address set to 11 (= 0000 1011 binary).

5.2.3 Digital Settings

	Factory settings	Selectable values
Baud rate	9600	9600, 19200, 38400, 57600, 76800, 115200
Data bits	8	8
Parity	EVEN	None, odd, even
Stop bits	1	1 or 2
Slave address	239	1...247

Tab. 2 Data transmission

ID address, baud rate, parity and stop bits can be set via:

1. EE-PCS, Product Configuration Software and the appropriate configuration cable.
2. Modbus protocol in the register 60001 (0x00) and 60002 (0x01). See Application Note Modbus AN0103 (available on www.epluse.com/EE211)

The measured values are saved as a 32 bit float value and as 16 Bit signed integer, see the Modbus Register map below.

The serial number as ASCII-code is located at read register address 30001-30008 (16 bit per address). The firmware version is located at register address 30009 (bit 15...8 = major release; bit 7...0 = minor release).

The sensor name is located at register address 30010.

5.2.4 Modbus Register Map

FLOAT 32 bit (read register):			
Function code / Register number ¹⁾ [Dec]	Register address ²⁾ [Hex]	Parameter name	Unit ³⁾
30026	0x19	temperature	[°C], [°F]
30028	0x1B	relative humidity	[%]
30030	0x1D	water vapour partial pressure	[mbar], [psi]
30032	0x1F	dew point temperature	[°C], [°F]
30034	0x21	wet bulb temperature	[°C], [°F]
30036	0x23	absolute humidity	[g/m ³], [g/ft ³]
30038	0x25	mixing ratio	[g/kg], [gr/lb]
30040	0x27	specific enthalpy	[kJ/kg], [BTU/lb]
30042	0x29	frost point temperature	[°C], [°F]

Tab. 3 Float (read register)

INTEGER 16 bit (read register):				
Function code / Register number¹⁾ [Dec]	Register address²⁾ [Hex]	Parameter name	Unit³⁾	Scale⁴⁾
30301	0x12C	temperature	[°C], [°F]	100
30302	0x12D	relative humidity	[%]	100
30303	0x12E	water vapour partial pressure	[mbar], [psi]	100
30304	0x12F	dew point temperature	[°C], [°F]	100
30305	0x130	wet bulb temperature	[°C], [°F]	100
30306	0x131	absolute humidity	[g/m ³], [g/ft ³]	100
30307	0x132	mixing ratio	[g/kg], [gr/lb]	100
30308	0x133	specific enthalpy	[kJ/kg], [BTU/lb]	100
30309	0x134	frost point temperature	[°C], [°F]	100

Tab. 4 Integer 16 bit (read register)

INTEGER 16 bit (read and write register):		
Function code / Register number¹⁾ [Dec]	Register address²⁾ [Hex]	Parameter name
60001	0x00	Slave-ID ⁵⁾ modbus address
60002	0x01	Modbus protocol settings ⁶⁾

Tab. 5 Integer 16 bit (read and write register)

INFO (read register):		
Function code / Register number¹⁾ [Dec]	Register address²⁾ [Hex]	Parameter name
30001	0x00	Serial number (as ASCII)
30009	0x01	Firmware version
30010	0x09	Sensor Name

Tab. 6 Info (read register)

1) Register number starts from 1

2) Register address starts from 0

3) The choice of measurement units (metric or non-metric) must be done in the ordering guide, see EE211 data sheet. Switching from metric to non-metric or vice versa by using the EE-PCS is not possible.

4) 100 is scale 1:100 (2550 is equivalent to 25.5 °C)

5) If the ID is set via DIP-switch the response will be NAK

6) For Modbus protocol settings please see Application Note Modbus AN0103 (available on www.epluse.com/EE211)

5.2.5 Reading Example

Example of MODBUS RTU command for reading the temperature (float value) T = 26.652524 °C from the register 0x19:

Device EE211; slave ID 239 [EF in Hex]

Reference document, chapter 6.3: www.modbus.org/docs/Modbus_Application_Protocol_V1_1b.pdf

Request [Hex]: EF 03 00 19 00 02 EB 7B

	Modbus ID address	Function code	Starting address Hi	Starting address Lo	No. of register Hi	No. of register Lo	CRC	
Request [Hex]:	EF	03	00	19	00	02	EB	7B

Response [Hex]: EF 03 04 38 5F 41 D5 0A E3

	Modbus ID address	Function code	Byte count	Register 1 value Hi	Register 1 value Lo	Register 2 value Hi	Register 2 value Lo	CRC	
Response [Hex]:	EF	03	04	38	5F	41	D5	0A	E3

For decoding of float values (stored according standard IEEE754), please refer to AN0103, chapter 7. (available on www.epluse.com/ee211).

Example of decoding:

Response [Hex]:				Value in decimal
Byte 1 (Register 2 - Hi)	Byte 2 (Register 2 - Lo)	Byte 3 (Register 1 - Hi)	Byte 4 (Register 1 - Lo)	
41	D5	38	5F	26.652524

6 Maintenance

6.1 Cleaning

If needed, the sensing head of the humidity probe can be cleaned by the user (see cleaning instruction - www.epluse.com/cleaning-instructions). The EE07-MT probe does not require any special cleaning because the temperature sensor is encapsulated in the stainless steel body of the probe.

6.2 Filter Replacement

In a dusty, polluted environment it might be necessary to replace the filter cap once in a while. In most of the cases, a clogged filter shows visible contamination or dirt. Longer response time of the RH measurement also indicates a clogged filter cap. In such cases, replace the filter by a new, original one, see data sheet "Accessories".

Procedure:

- Turn the filter cap counter-clockwise for removing it.
- Install the new filter cap fingertight by turning it clockwise

6.3 Adjustment and Calibration

6.3.1 Definitions

Calibration

The calibration documents the accuracy of a measurement device. The device under test (specimen) is compared with the reference and the deviations are documented in a calibration certificate. During the calibration, the specimen is not changed or improved in any way.

Adjustment

The adjustment improves the measurement accuracy of a device. The specimen is compared with the reference and brought in line with it. An adjustment can be followed by a calibration which documents the accuracy of the adjusted specimen. The 2-point adjustment is recommended for best accuracy over a wide RH and / or T range.

6.4 RH and T Calibration / Adjustment

- One point (offset) calibration/adjustment at ambient T can be easily performed by comparison with an adequate RH and a T reference. The E+E Omniport 30 handheld device can serve for instance as such reference. Omniport 30 can be optionally supplied with an accredited calibration certificate. See E+E calibration brochure at www.eplusecal.com.
- For multiple point calibration or 2-point adjustment for RH and T, the EE211 as a whole (both probes) shall be placed in a climate chamber.

6.4.1 Adjustment Procedure

- Connect the EE211 to the a Windows PC, using the EE-PCS Product Configuration Software and the optional USB configuration adapter HA011066.
- EE-PCS (free download from www.epluse.com/configurator) shall be installed on the PC.
- Start EE-PCS and proceed with 1 or 2-point adjustment of the RH and of the T reading.

Please note:

The adjustment data is stored in the main electronics board of the EE211. The factory adjustment of the heated humidity probe and of the T probe is not altered. In case of replacing of the T probe it is necessary to return to the factory setup of EE211.

6.5 Individual Calibration / Adjustment of the T Probe

The T probe can be also adjusted separately, which might be desirable in high demanding applications. For best accuracy it is advisable to use a dry block calibrator.

6.5.1 Adjustment Procedure

- Connect the T probe to the a Windows PC using the EE-PCA product configuration adapter and the cable HA011057 (see data sheet EE-PCA).
- EE-PCS (free download from www.epluse.com/configurator) shall be installed on the PC.
- Start EE-PCS and proceed with the calibration or adjustment of the T reading.

Please note:

In case of individual adjustment, the adjustment data is stored in the T probe, the factory setup of the EE211 basis unit is not altered. Consequently, the T probe can be readjusted or replaced at any time without the need of readjusting the EE211 basis unit.

7 Technical Data

Measurands

Relative Humidity (RH)

Sensor	E+E Sensor HCT01-00D, protected by E+E proprietary coating	
Working range	0...100 % RH	
RH accuracy ¹⁾ (incl. hysteresis, non-linearity and repeatability)	$\pm(1.3 + 0.007 \cdot \text{measured value}) \% \text{ RH}$	-5...30 °C (23...86 °F)

Temperature (T)

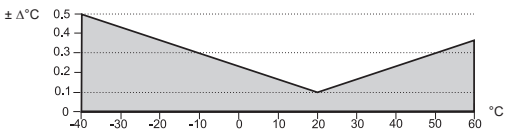
Sensor	Pt1000 (tolerance class A, DIN EN 60751)	
T-accuracy (at 20 °C (68 °F) : $\pm 0,1 \text{ °C}$)		

Outputs

Analogue output	0-5 V / 0-10 V	-1 mA < I _L < 1 mA	I _L = load current
(RH: 0...100 %; T: see ordering guide)	0-20 mA / 4-20 mA (3-wire)	R _L ≤ 500 Ohm	R _L = load resistor
Digital interface	RS485, Modbus RTU, max. 32 unit load devices in one bus		

General

Power supply (Class III) 	15 - 35 V DC ²⁾ or 24 V AC $\pm 20 \%$			
Current consumption at 24 V	AC		DC	
	without Display	with Display	without Display	with Display
	max. 38 mA _{rms}	max. 49 mA _{rms}	max. 13 mA	max. 19 mA
	typ. 75 mA _{rms}	typ. 85 mA _{rms}	max. 34 mA	max. 40 mA
	typ. 23 mA _{rms}	typ. 40 mA _{rms}	typ. 8 mA	typ. 17 mA
Display	1, 2 or 3 lines, user configurable, with backlight			
Connection	Screw terminals, max. 1.5 mm ²			
Enclosure material	Polycarbonate, UL94V-0 (with Display UL94HB) approved			
T-probe material	Stainless steel 1.4571			
Protection class	IP65 / NEMA 4			
Cable gland	M20 x 1.5			
Electromagnetic compatibility (Industrial Environment)	EN61326-1 EN61326-2-3			
Temperature range	Operation / Storage: -40...60 °C (-40...140 °F)			
Temperature range with display	Operation: -20...50 °C (-4...122 °F)			
	Storage: -20...60 °C (-4...140 °F)			



1) Traceable to intern. standards, administrated by NIST, PTB, BEV,...

The accuracy statement includes the uncertainty of the factory calibration with an enhancement factor k=2 (2-times standard deviation).

The accuracy was calculated in accordance with EA-4/02 and with regard to GUM (Guide to the Expression of Uncertainty in Measurement).

2) USA & Canada: class 2 supply required, max. supply voltage 30V