

Instruction Manual

Marathon Bluetooth Alarm Clock with Temperature and Humidity Sensor

CL800002WH/CL800002GH



MARATHON

Marathon Watch Company Ltd.

TF: 1.800.822.4329 • T: 905.764.9420 • F: 905.764.0035
www.MarathonWatch.com

Main Unit

Location of Control

1. Snooze button
2. Alarm on/off
3. Pair
4. Scroll
5. Reset
6. Battery Compartment
7. Battery door

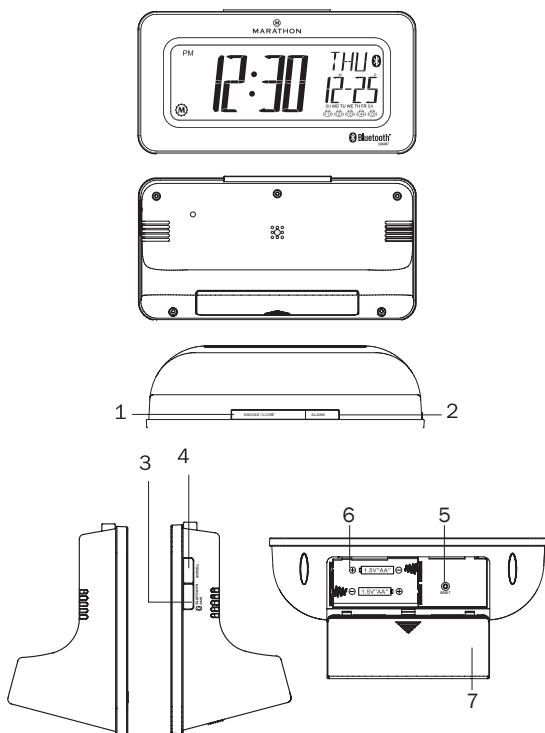

Features

Thank you for purchasing the Marathon Bluetooth Alarm Clock. This product is designed to work with iPad, iPhone, iPod, other iOS devices and Android 4.3 or above devices.

- Supports iOS version 7.1 or above
- Supports Android version 4.3 or above
- Up to 5 alarms with snooze function
- Take full control of the Bluetooth Alarm Clock with app
- Selectable alarm tone pattern and volume
- Temperature and Humidity reading with history chart that can be read on App without alarm clock connection
- Count down timer
- Monitor the battery status of the Bluetooth Alarm Clock and have battery warning if it is at low level
- Can stop alarm via App
- Operating temperature is 0°C to 40°C (23°F ~ 104°F)

Before you start using it:

- Please make sure to read the instruction manual carefully.
- Following and respecting the instructions in your manual will prevent damage to your instrument and avoid causing your warranty to become void.
- We shall not be liable for any damage occurring as a result of not following these instructions. Likewise, we take no responsibility for any incorrect readings and for any consequences which may result from them
- Please take particular note of the safety advice!
- Please keep this instruction manual for future reference

Getting Started

1. Install battery
 - 1.1 Open the battery compartment.
 - 1.2 Insert 2 x AA size batteries in polarity (+) and (-) as indicated.
 - 1.3 Close the battery compartment.

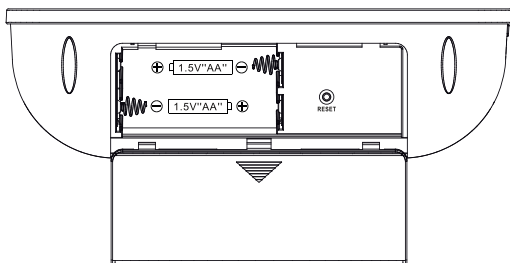

2. Install Clock System App on your device.
 - 2.1 Access App Store or Google play search for Clock System. 
 - 2.2 Select and install Clock System App on your mobile device.

Please Note:

User manual is based on iOS version and may differ with Android version which will be specified as supplementary information at bottom of relative page.

Pairing the Bluetooth Alarm Clock

3. Pair the Bluetooth Alarm Clock with Clock System App.

3.1 Before running the Clock System App, make sure your device has Bluetooth enabled.

3.2 After you tap the app icon , the 'Nearby Devices' screen appears. You need to pair the Bluetooth Alarm Clock device before you enter the main app screen.

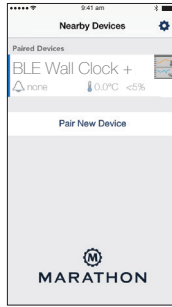
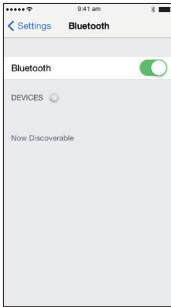

iOS Version

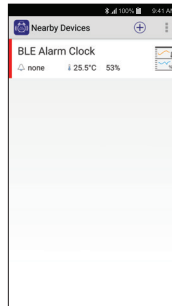
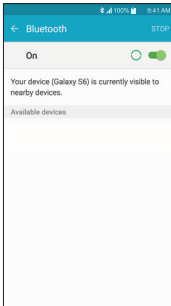

Android Version

Pairing the Bluetooth Alarm Clock

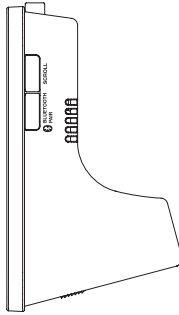

3.3 Tap “ Pair New Device” to search for nearby devices.

3.4 Press and hold the [PAIR] button on the Bluetooth Alarm Clock device for 5 seconds. You will see that the  icon will start to blink on the clock

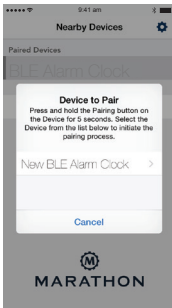

iOS Version

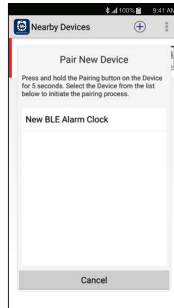

Android Version

3.5 The new Marathon Bluetooth Alarm Clock will be displayed on the App and is ready for pairing. Tap the Marathon “Bluetooth Alarm Clock” to start the pairing and connection process. Once the Bluetooth Alarm Clock + is paired, it will start time and data synchronization.

Pairing the Bluetooth Alarm Clock



iOS Version

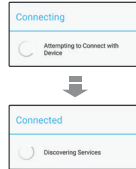
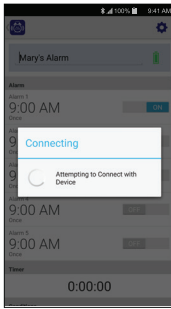

Android Version

3.6 After the connection is made, the following information will be synchronized:

- i) Current time and date
- ii) Alarms & timer setting
- iii) Unit battery level
- iv) Temperature and Humidity history

Pairing the Bluetooth Alarm Clock



No Bluetooth connection



Bluetooth establishing connection



Bluetooth connected successfully

3.7 When the Bluetooth Wall Clock is paired with one device, clock must be reset to pair with other devices.

3.8 One device can pair with a maximum of 5 Bluetooth Alarm Clocks at once.

Rename the Bluetooth Alarm Clock

4. Rename the device.

Tap the device name (default is “Bluetooth Alarm Clock”) at the top of the screen to edit the device name.

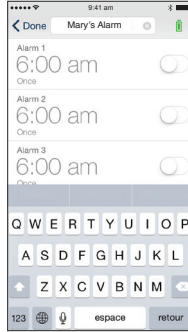
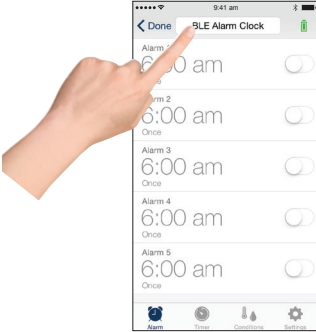

iOS Version

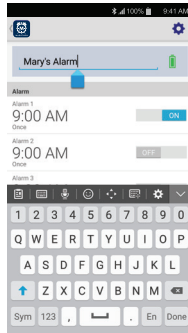
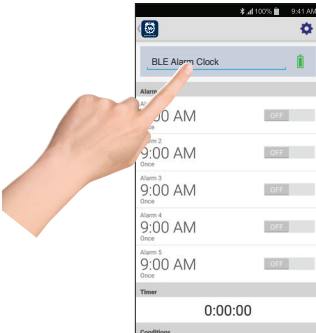

Android Version

Battery Status Indicator

5. Battery status indicator:
Indicates the battery level of your Bluetooth Alarm Clock device. When the battery level drops below 20%, the battery icon is in red status and a low battery warning will pop up as a reminder to replace the battery.

Meanwhile, low battery indicator icon will be shown on the alarm clock LCD.

Above 60% 

Between 20% ~ 60% 

Below 20% 

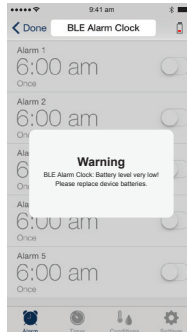

iOS Version

Above 60% 

Between 20% ~ 60% 

Below 20% 

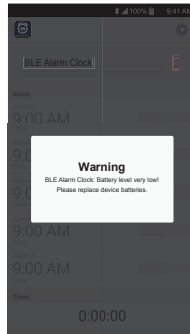

Android Version

Setting the Alarm Time

6. Setting the alarm time

6.1 Each Marathon Bluetooth Alarm Clock can set up to a maximum of 5 Alarms. On the main screen, tap individual alarm (e.g. Alarm 1) to enter the alarm setting page.

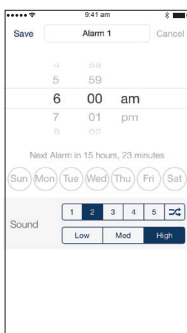

iOS Version

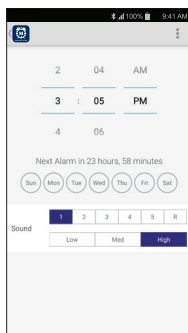

Android Version





6.2 The alarm setting screen appears. You can edit and adjust different items on this screen, which include:

- i) Alarm Name: Tap alarm 1- 5 to edit your preferred name to this alarm.
- ii) Time: Tap to adjust the time for this alarm.
- iii) Day of Week: Tap to select which day of week to enable the alarm.
 - If none are selected, the alarm will only sound once.
 - If all days are selected, it will sound daily .
- iv) Sound pattern: Tap to select which tone pattern (5 patterns plus one random pattern available) is applied to this alarm.

Setting the Alarm Time

- v) Alarm volume level: Tap to select the alarm sound volume level (three options: Low, Med and High).

6.3 Complete the alarm setting.

- i) Tap [Done] /  to save the alarm setting and turn on the alarm.
- ii) At the main screen, user can turn the alarm on / off by scrolling the  right and left.

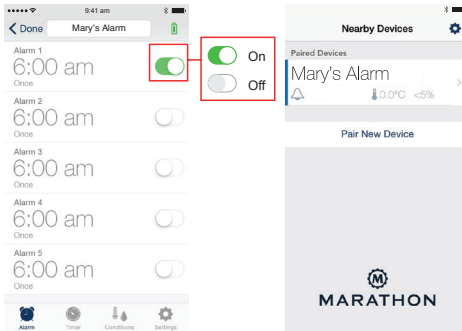

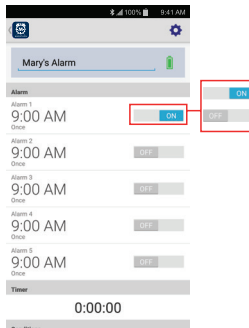

iOS Version



Android Version

Remote Alarm OFF

6.4 Stop the alarm via App. (iOS version only)

- i) When the alarm sounds, enter the App and tap the blinking icon  located under Paired Devices
- ii) Tap the  icon to stop the alarm.

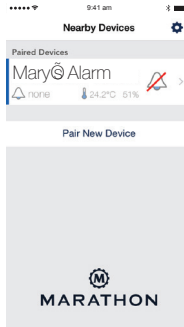

iOS Version

6.5 Stop the alarm during lockscreen. (iOS version only)

- i) An alarm notification will pop up on the lockscreen. Swipe right on the notification and tap “Alarm Cancel” to stop alarm or “Snooze” to enter snooze mode.
- ii) For Android version, the notification icon appears at the top of status bar. Slide down the status bar to show the notification and tap “Alarm Cancel” to stop alarm or “Snooze” to enter snooze mode.

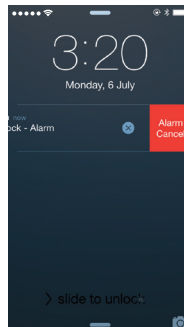
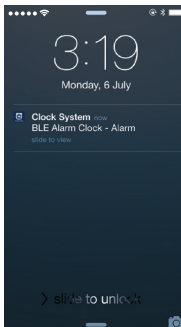

Snooze Operation

7. Using the SNOOZE function

- 7.1 When the alarm sounds, press the [SNOOZE] button to get an extra 5 minutes of sleep. The snooze will repeat up to three times.

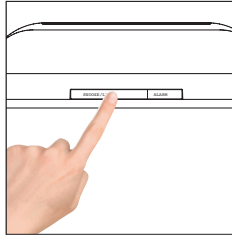

iOS Version

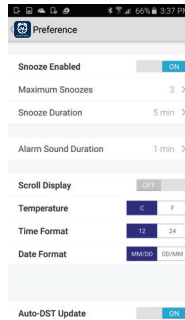

Android Version

- 7.2 The above default value is set by the factory. User can set the "Maximum Snoozes" and "Snooze Duration" in the preference screen.

To Turn OFF the Alarm

8. To disable the alarm

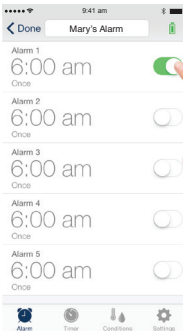
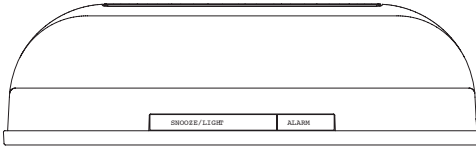

iOS Version

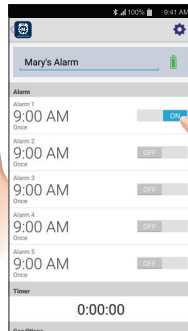

Android Version

- 8.2 The alarm will sound for 1 minute and stop automatically.
If Snooze is enabled setting is ON, the alarm will repeat every 5 minutes. You can press the [Snooze] button to interrupt the alarm momentarily, or can press [Alarm] button to turn off the alarm and stop the snooze function completely.
- 8.3 User can tap the alarm time to disable the alarm completely
(Please make sure your app is paired with the device)

Setting the Timer

9. To set the timer:
Tap timer on main screen and go into timer screen.

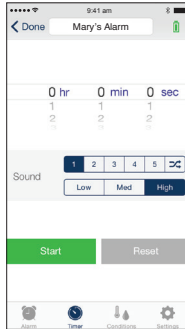

iOS Version

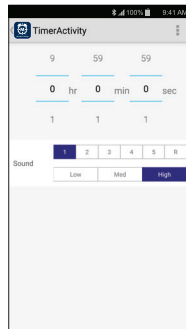
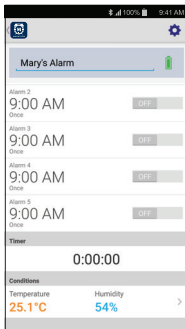

Android Version

- 9.1 You can edit and adjust the following items on this screen:
- Timer period:
Scroll to adjust the timer period.
 - Sound pattern:
Tap to select the tone pattern (5 patterns plus one random pattern available).
 - Sound volume level:
Tap to select the sound volume level (three options: Low, Med and High).

Setting the Timer

9.2 Using the Timer

In the Home screen, you can tap “Start” under Timer to start counting.

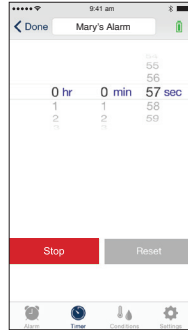
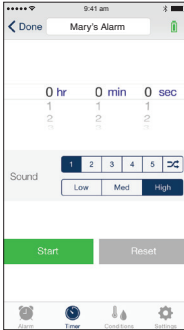

iOS Version

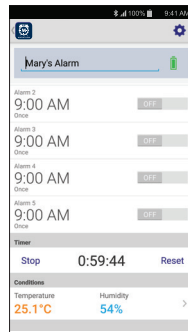
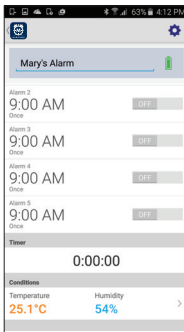

Android Version



Then you can tap “Stop” to stop the current timer and “Start” to re-continue the timer again. The timer can be reset by tapping the [Reset].

Deleting the Bluetooth Alarm Clock Record

10. Delete the Marathon Bluetooth Alarm Clock record.

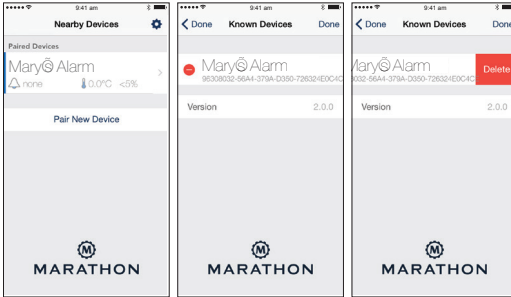

iOS Version



You can tap the  at Nearby Devices screen to enter the Known Devices page. By tapping “Edit” and then the , you can select “Delete” to delete the Bluetooth Alarm Clock record on the current device.

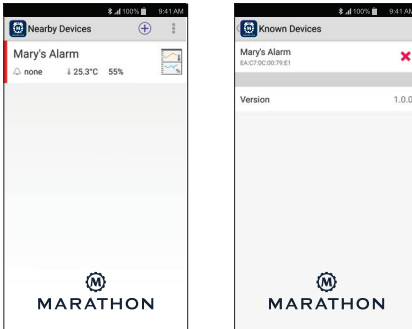

Android Version



You can tap the  at Nearby Devices screen to enter the Known Devices page. By tapping “Edit” and then the , you can select “Delete” to delete the Bluetooth Alarm Clock record on the current device.

Preference

11. Preference setting

Tap the  /  to enter the Preference screen. You can edit and adjust the following items on this screen.

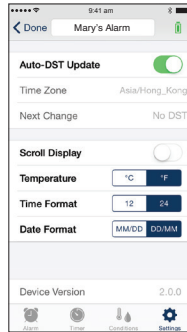
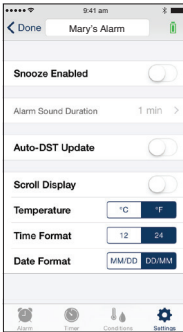

iOS Version

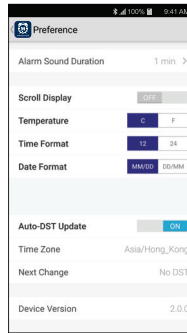
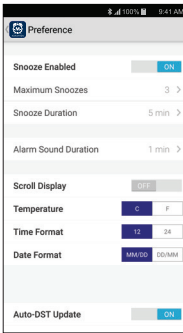

Android Version

Preference

- 11.1 Snooze Enabled: Tap to select ON/OFF to enable/disable the Snooze function. If Snooze Enabled is ON, you will have two more options, which are:

Maximum Snoozes:

The maximum number of times to repeat the snooze function, which can be set to Unlimited or values from 1 to 9.

Snooze Duration:

The time duration ofv snooze function, which can be set to values from 1 to 15 minutes.

- 11.2 Alarm Sound Duration:

The alarm duration, which can be set to values from 1 to 15 minutes.

- 11.3 Auto DST update:

It will adjust Daylight Saving Time (DST) automatically based on your device time zone setting. The alarm clock will be automatically one hour ahead of Standard Time in summer time and will be back to the normal Standard Time when back to winter time, according to your device's time zone.

- 11.4 Scroll Display:

Turn on to enable the LCD screen to switch automatically (screen detail please refer to point 14)

- 11.5 Temperature: Select °C or °F

- 11.6 Time Format: Select 12 or 24 hour format

- 11.7 Date Format: Select MM / DD or DD/ MM day format.

Reset the Bluetooth Alarm Clock

12. Reset the Bluetooth Alarm Clock

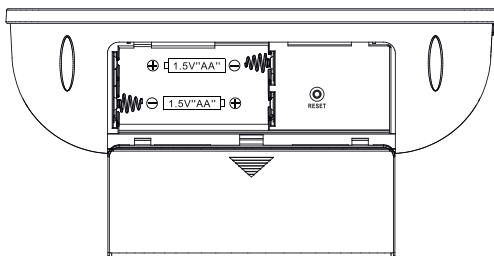

If the Bluetooth Alarm Clock is not working properly, try to press RESET button to resume default setting. The LED flashes twice in (purple) colour, then the LED will flash once per 6 seconds in red colour.

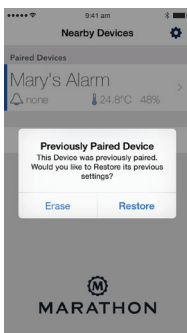

iOS Version

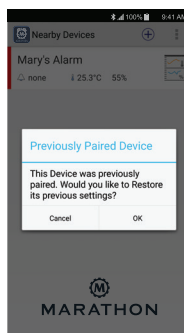

Android Version

After reset, all data in the Bluetooth Alarm Clock is deleted. Press and hold the [PAIR] button again to re-pair the Bluetooth Alarm Clock. If it has been paired previously with the same device, you can select "Restore" to resume all setting and data or select "Erase" to start all from scratch.

Temperature and Relative Humidity

13. Current Temperature and Relative Humidity (Conditions)

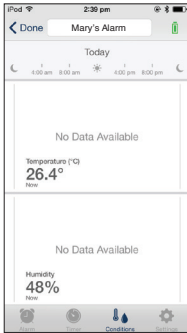

iOS Version

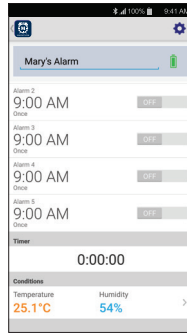

Android Version

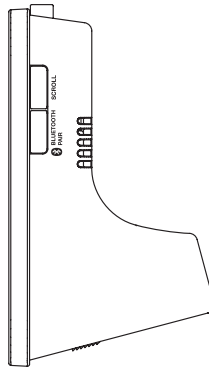

- 13.1 The unit can measure temperature and relative humidity. The current temperature and humidity reading will be shown on the App or you can browse it on the Bluetooth Alarm Clock LCD screen by pressing the “Scroll” button.

Temperature and Relative Humidity

13.2 The unit can accumulate temperature / humidity readings up to 7 days. To read the data tap the conditions then go into the historical chart showing temperature / relative humidity reading by time and date, including the maximum and minimum record of each day. Number of historical records stored in app depends on your device memory.

Note:

(Resetting the unit will clear all memory stored in the unit and the record in app after synchronization.)

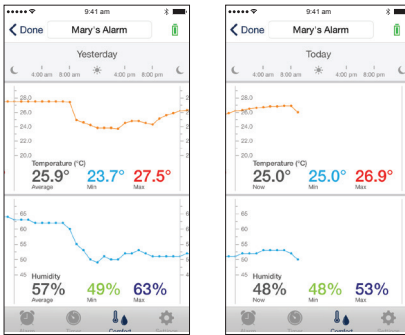

iOS Version

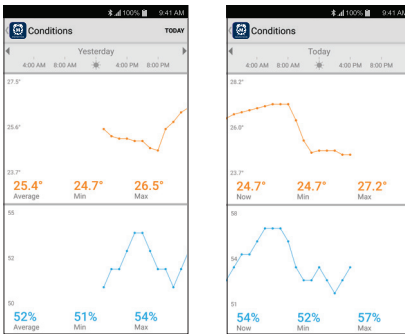

Android Version

Offline Temperature and Humidity Reading

13.3 When the Marathon Clock and App are offline, user can still read the latest history record from the last connection by tapping the chart icon on the right hand side of specific unit list in Nearby Devices screen.

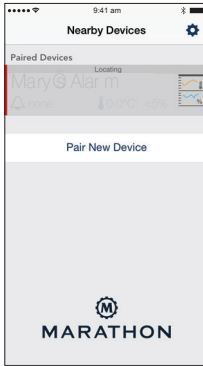

iOS Version

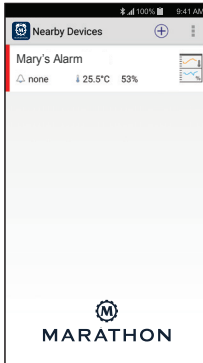

Android Version

Scroll Function

14. You can press the [Scroll] button on the Bluetooth Alarm Clock to switch between different information manually. Or you can press and hold the [Scroll] button to enable/disable auto-scrolling display function.

14.1 The scrolling display will be in following order:

“Clock with calendar mode”



“Calendar mode”

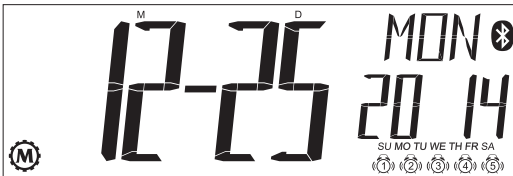

Scroll Function

“Temperature and humidity with clock mode”



“Clock with alarm time mode”
(show if any alarm enabled)



TIMER mode
(only if the timer is running)

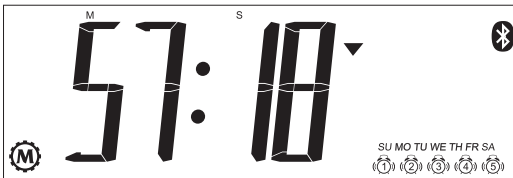

14.2 In auto-scrolling mode, each mode will stay 3 seconds and then switch to next display.

Care of your Bluetooth Alarm Clock

- The unit should not be exposed to dripping or splashing of liquid.
- Do not expose unit and/or batteries to liquid, sand or excessive heat.
- No objects filled with liquids, such as vases, shall be placed on the unit.
- Do not cover the unit. Allow adequate space with a small gap between the buzzer holes and surrounding surfaces.
- To clean the set, use a soft dry cloth. Do not use any cleaning agents containing alcohol, ammonia, benzene or abrasives as these may harm the housing.

Manufacturer reserves the right to update the contents of this manual and App.

Your product is designed and manufactured with high quality materials and components, which can be recycled and reused. When this crossed-out wheeled bin symbol is attached to a product it means the product is covered by the European Directive 2002/96/EC. Please inform yourself about the local separate collection system for electrical and electronic products.



Please act according to your local rules and do not dispose of your old products with your normal household waste. The correct disposal of your old product will help prevent potential negative consequences for the environment and human health.

Disposal of Flat Batteries / Accumulators

You, as the end user, are legally obliged (Battery Ordinance) to return all flat batteries and rechargeable batteries.

Disposal in the household waste is prohibited. "European Directive 2006/66/EC" Batteries, including rechargeable batteries, which contain hazardous substances are marked by symbols which indicate the prohibition of disposal in the household waste. The designations for the heavy metals concerned are as follows:

Cd = cadmium, **Hg** = mercury, **Pd** = lead. You can return flat batteries / rechargeable batteries free of charge to the collection points in your community or anywhere where batteries / rechargeable batteries are sold. You thus fulfill your statutory obligations and help protect the environment.



Caution

Replace only with the same or equivalent type of battery, please refer to the engraved battery marks inside the battery compartment for the correct battery polarity (+) and (-). Danger of explosion is possible if battery is incorrectly replaced.

This product complies with the requirement of the 1999/5/EC directive.

Use this unit and mobile phone only in environments with ambient temperatures between 0°C and 40°C.

And the maximum operating temperature of the unit is 40°C

FCC Statement

This device complies with Part 15 of the FCC rules. Operation is subject to the following two conditions: (1) This device may not cause harmful interference, and (2) This device must accept any interference received, including interference that may cause undesired operation.

Warning: Changes or modifications to this unit not expressly approved by the party responsible for compliance could void the user's authority to operate the equipment.

NOTE: This equipment has been tested and found to comply with the limits for a Class B digital device, pursuant to Part 15 of the FCC Rules. These limits are designed to provide reasonable protection against harmful interference in a residential installation. This equipment generates, uses and can radiate radio frequency energy and, if not installed and used in accordance with the instructions, may cause harmful interference to radio communications.

However, there is no guarantee that interference will not occur in a particular installation. If this equipment does cause harmful interference to radio or television reception, which can be determined by turning the equipment off and on, the user is encouraged to try to correct the interference by one or more of the following measures:

- Reorient or relocate the receiving antenna.
- Increase the separation between the equipment and the receiver.
- Connect the equipment into an outlet on a circuit different from that to which the receiver is connected.
- Consult the dealer or an experienced radio/TV technician for help.

Japan Radio Law Statement

This product contains the certified module by Japan Radio Law. The certification number is



018-140077

BAC