

YAUFEY

Home Dehumidifier

Please read this manual carefully
before using the product

JD026R-150

USER MANUAL

FOR CUSTOMERS

Thank you for purchasing our dehumidifier.

Yaufey has been committed to developing powerful and easy-to-use products to bring more convenience to your life. We highly recommend you to keep this user manual for future reference in case of unexpected problems.

Please read this user manual carefully to ensure proper use of the dehumidifier. This dehumidifier is perfect for reducing humidity in family bedrooms, bathrooms, basements, offices, storage rooms and more.

Yaufey dehumidifier reduce the room humidity efficiently, creating a more healthy and comfortable environment for you and your family.

REQUESTING CUSTOMER SERVICE

If there are any problems of the product, please contact Yaufey Customer Service at support@yaufey.com with your Purchase Order ID. We'll help you solve the problems as soon as possible.

BEFORE FIRST USE:

To protect the product from any internal damages, please keep the product in the upright position throughout its journey.

Please take out the product and leave it standing in the upright position for **24 HOURS** before plugging it in.

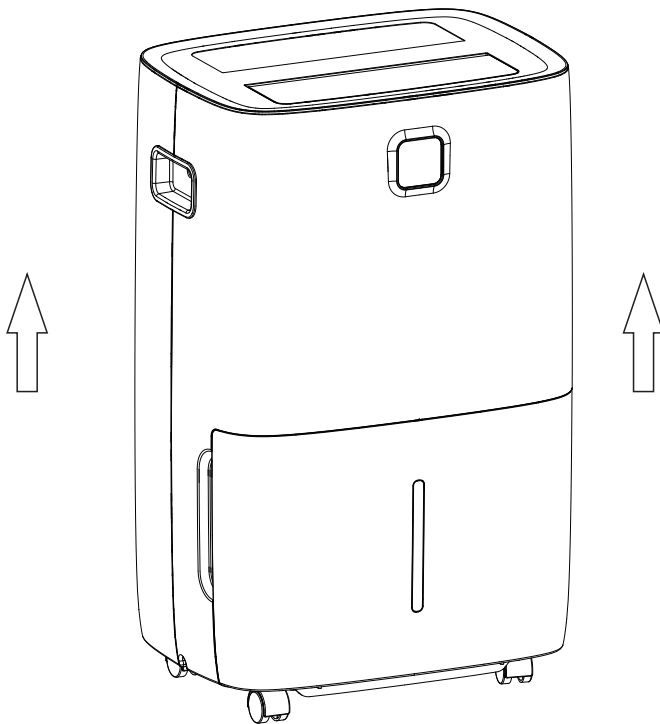

TABLE OF CONTENTS

FEATURES	01
SAFETY PRECAUTIONS.....	02
IMPORTANT SAFETY INSTRUCTIONS	04
SPECIFICATIONS	17
PRODUCT DIAGRAM	18
OPERATION INSTRUCTIONS	19
DRAINAGE	21
MAINTENANCE & CLEANING	24
TROUBLESHOOTING	25
SPECIAL NOTES.....	26
WARRANTY & CONTACT US	27

FEATURES

Powerful Moisture Removal

With the cutting-edge technology, the dehumidifier powerfully removes moisture from the air to reduce the room humidity level and keep the indoor air dry and comfortable.

Lightweight Portable Design

The dehumidifier is built to be compact and lightweight. The casters on the bottom of the unit make it easy to move from room to room.

Low Temperature Operation with Automatic Defrost Function

After the compressor runs continuously for 10 minutes, start to detect the temperature of the coil. When the temperature of the coil is $<-2^{\circ}\text{C}$ (28.4°F) for more than 10 seconds, the compressor will stop working immediately, and the fan will start to run at high speed. After 3 minutes, when it is detected that the coil temperature is $\geq 5^{\circ}\text{C}$ (41°F) for more than 10 seconds, then exit the anti-frost, and the compressor and fan will return to normal; (if the anti-frost time is longer than 10 minutes, it will automatically exit)

During the anti-frost period, if the water is full, the fan will be turned off. After the water level is restored, the fan will resume forced high-wind operation; (if the anti-frost time is longer than 10 minutes, it will automatically exit)

※ During defrosting, the defrosting light is always on.

Adjustable Humidistat

Allows you to set different humidity levels for different rooms.

Timer On / Off

Program the unit to turn on and off automatically.

Quiet Operation

The dehumidifier operates with a low noise level.

Energy Efficient

The power consumption of the unit is low.

SAFETY PRECAUTIONS

IMPORTANT NOTICE FOR FIRST USE :

For your safety, please read the manual carefully and keep it for future reference.

Please install and use this product according to the instructions in the manual.

- Please unplug the power cord before cleaning or storing the machine .
- The machine can be used indoor except for laundry rooms.
- Do not place the machine close to heat-generating devices or flammable and dangerous materials.
- Never put your fingers or other objects into the intake or discharge ducts.
- Do not sit or stand on the machine.
- Pour out the collected water in the tank as required.
- Do not operate the dehumidifier in a closed area such as a closet, as it may cause a fire.
- Do not place the machine near edible items, artwork, or scientific materials.
- Install the drain hose at a downhill grade to make sure that condensed water can be drained continuously.
- If the power cord is damaged, please contact the manufacturer or qualified person to replace it to avoid hazards.
- The machine must be positioned so that the plug is accessible.
- Please keep a distance of 7.87 in away from the wall or other objects to ensure great air circulation.
- The machine shall be installed in accordance with local national wire regulations.
- The machine can not be used in public transportation.
- This machine can be used by children aging from 8 years and above and persons with reduced physical, sensory or mental capabilities or lack experience and knowledge if they have been given supervision or instructions of the machine in a safe way and understand the hazards involved. Children shall not play with the machine. Cleaning and user maintenance shall not be made by children without supervision.
- Children should be supervised to ensure that they do not play with the machine.
- Please do not operate the machine if it is obviously damaged.

SAFETY PRECAUTIONS

WARNINGS

- Do not accelerate the defrosting process or clean the ice by yourself, other than those recommended by the manufacturer.
- Do not pierce or burn the machine .
- Be aware that refrigerants may not have an odour.
- The machine shall be installed, operated and stored in a room with a floor area larger than 4m².
- The machine shall comply with national gas regulations.
- Servicing shall be performed only as recommended by the manufacturer.
- When not in use for a long time, the machine shall be stored to prevent mechanical damage.
- If you need to repair the machine, please contact the nearest authorized Service Centre and strictly follow manufacturer's instruction only.

Storing the Dehumidifier

When the unit is not being used for a long period of time and you want to store it. Please note the following steps:

1. Empty any water left in the water tank.
2. Fold up the power supply cord and put it in the water tank.
3. Clean the air filter.
4. Place it in a cool and dry place.

Clearance

Maintain the minimum clearance around the dehumidifier when the unit is operating as shown in the left drawing.

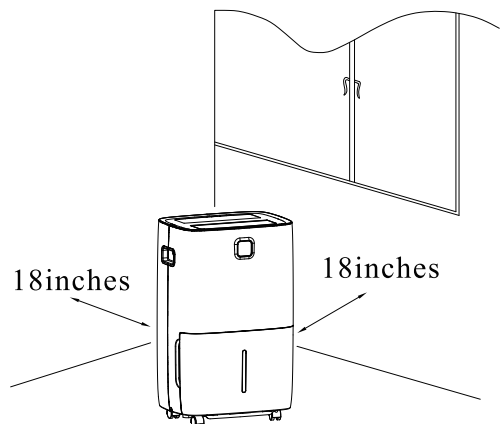

Important Safety Instructions

General Safety Instructions

- The dehumidifier is only suitable for indoor use, and is not suitable for other applications.
- Place the machine in a flat and dry place and keep a distance of above 18in between the machine and the surrounding objects or walls.
- Please ensure that the power plug is intact and firmly plugged into the power outlet, and place the power cord orderly to prevent someone from being tripped or pulling out the plug.
- Do not put any object into the air inlet and outlet of the dehumidifier. Keep the air inlet and outlet free from obstructions.
- When drainage pipes are installed, ensure that the drainage pipes are properly connected, and are not distorted or bended.
- While adjusting the upper and lower wind-guide strips of the air outlet, pluck it with hands gently to avoid damaging wind-guide strips.
- When moving the machine, make sure that it is in an upright position.
- The machine should stay away from gasoline, flammable gas, stoves and other heat sources.
- Don't disassemble, overhaul and modify the machine arbitrarily, otherwise it will cause a machine malfunction or even bring harm to persons and properties. To avoid danger, if a machine failure occurs, ask the manufacturer or professionals to repair it.
- Do not pull the plug to turn off the machine.
- Do not place cups or other objects on the body to prevent water or other liquids from spilling into the dehumidifier.
- Do not use insecticide sprays or other flammable substances near the dehumidifier
- Do not wipe or wash the dehumidifier with chemical solvents such as gasoline and alcohol. When you need to clean the dehumidifier, you must disconnect the power supply, and clean it with a half-wet soft cloth. If the machine is really dirty, scrub with a mild detergent.
- The appliance can be used by children aged from 8 years and above and persons with reduced physical, sensory or mental capabilities if they have been given supervision or instruction concerning use of the appliance in a safe way and understand the hazards involved. Children shall not play with the appliance. Cleaning and maintenance shall not be made by children without supervision.
- If the supply cord is damaged, it must be replaced by the manufacturer, its service agent or similarly qualified persons in order to avoid a hazard.

Important Safety Instructions

- If the supply cord is damaged, it must be replaced by the manufacturer, its service agent or similarly qualified persons in order to avoid a hazard.
- The appliance shall be stored so as to prevent mechanical damage from occurring.
- The appliance shall be installed in accordance with national wiring regulations.

Special Safety Instructions for using flammable refrigerant

1. Transport of equipment containing flammable refrigerants

- Compliance with the transport regulations

2. Marking of equipment using signs

- Compliance with local regulations

3. Disposal of equipment using flammable refrigerants

- Compliance with national regulations

4. Storage of equipment/appliances

- The storage of equipment should be in accordance with the manufacturer's instructions.

5. Storage of packed (unsold) equipment

- Storage package protection should be constructed such that mechanical damage to the equipment inside the package will not cause a leak of the refrigerant charge.
- The maximum number of pieces of equipment permitted to be stored together will be determined by local regulations.

6. Information on servicing

Important Safety Instructions

6-1 Checks to the area

- Prior to beginning work on systems containing flammable refrigerants, safety checks are necessary to ensure that the risk of ignition is minimised.
- For repair to the refrigerating system, the following precautions shall be complied with prior to conducting work on the system.

6-2 Work procedure

- Work shall be undertaken under a controlled procedure so as to minimise the risk of a flammable gas or vapour being present while the work is being performed.

6-3 General work area

- All maintenance staff and others working in the local area shall be instructed on the nature of work being carried out. Work in confined spaces shall be avoided.
- The area around the workspace shall be sectioned off. Ensure that the conditions within the area have been made safe by control of flammable material.

6-4 Checking for presence of refrigerant

- The area shall be checked with an appropriate refrigerant detector prior to and during work, to ensure the technician is aware of potentially flammable atmospheres.
- Ensure that the leak detection equipment being used is suitable for use with flammable refrigerants, i.e. non-sparking, adequately sealed or intrinsically safe.

6-5 Presence of fire extinguisher

- If any hot work is to be conducted on the refrigeration equipment or any associated parts, appropriate fire extinguishing equipment shall be available to hand.
- Have a dry powder or CO2 fire extinguisher adjacent to the charging area.

6-6 No ignition sources

- No person carrying out work in relation to a refrigeration system which involves exposing any pipe work that contains or has contained flammable refrigerant shall use any sources of ignition in such a manner that it may lead to the risk of fire or explosion.
- All possible ignition sources, including cigarette smoking, should be kept

Important Safety Instructions

sufficiently far away from the site of installation, repairing, removing and disposal, during which flammable refrigerant can possibly be released to the surrounding space.

- Prior to work taking place, the area around the equipment is to be surveyed to make sure that there are no flammable hazards or ignition risks. “No Smoking” signs shall be displayed.

6-7 Ventilated area

- Ensure that the area is in the open or that it is adequately ventilated before breaking into the system or conducting any hot work.
- A degree of ventilation shall continue during the period that the work is carried out.
- The ventilation should safely disperse any released refrigerant and preferably expel it externally into the atmosphere.

6-8 Checks to the refrigeration equipment

- Where electrical components are being changed, they shall be fit for the purpose and to the correct specification.
- At all times the manufacturer’s maintenance and service guidelines shall be followed. If in doubt consult the manufacturer’s technical department for assistance.
- The following checks shall be applied to installations using flammable refrigerants:
 - The charge size is in accordance with the room size within which the refrigerant containing parts are installed;
 - The ventilation machinery and outlets are operating adequately and are not obstructed;
 - If an indirect refrigerating circuit is being used, the secondary circuit shall be checked for the presence of refrigerant;
 - Marking to the equipment continues to be visible and legible. Markings and signs that are illegible shall be corrected;
 - Refrigeration pipe or components are installed in a position where they are unlikely to be exposed to any substance which may corrode refrigerant containing components, unless the components are constructed of materials which are inherently resistant to being corroded or are suitably protected against being so corroded.

Important Safety Instructions

6-9 Checks to electrical devices

- Repair and maintenance to electrical components shall include initial safety checks and component inspection procedures.
- If a fault exists that could compromise safety, then no electrical supply shall be connected to the circuit until it is satisfactorily dealt with.
- If the fault cannot be corrected immediately but it is necessary to continue operation, an adequate temporary solution shall be used.
- This shall be reported to the owner of the equipment so all parties are advised.
- Initial safety checks shall include:
 - That capacitors are discharged: this shall be done in a safe manner to avoid possibility of sparking;
 - That there no live electrical components and wiring are exposed while charging, recovering or purging the system;
 - That there is continuity of earth bonding.

7. Repairs to sealed components

- During repairs to sealed components, all electrical supplies shall be disconnected from the equipment being worked upon prior to any removal of sealed covers, etc.
- If it is absolutely necessary to have an electrical supply to equipment during servicing, then a permanently operating form of leak detection shall be located at the most critical point to warn of a potentially hazardous situation.
- Particular attention shall be paid to the following to ensure that by working on electrical components, the casing is not altered in such a way that the level of protection is affected.
- This shall include damage to cables, excessive number of connections, terminals not made to original specification, damage to seals, incorrect fitting of glands, etc.
- Ensure that apparatus is mounted securely.
- Ensure that seals or sealing materials have not degraded such that they no longer serve the purpose of preventing the ingress of flammable atmospheres.
- Replacement parts shall be in accordance with the manufacturer's specifications.

NOTE:

The use of silicon sealant may inhibit the effectiveness of some types of leak detection equipment. Intrinsically safe components do not have to be isolated prior to working on them.

Important Safety Instructions

8. Repair to intrinsically safe components

- Do not apply any permanent inductive or capacitance loads to the circuit without ensuring that this will not exceed the permissible voltage and current permitted for the equipment in use.
- Intrinsically safe components are the only types that can be worked on while live in the presence of a flammable atmosphere. The test apparatus shall be at the correct rating.
- Replace components only with parts specified by the manufacturer.
- Other parts may result in the ignition of refrigerant in the atmosphere from a leak.

9. Cabling

- Check that cabling will not be subject to wear, corrosion, excessive pressure, vibration, sharp edges or any other adverse environmental effects.
- The check shall also take into account the effects of aging or continual vibration from sources such as compressors or fans.

10. Detection of flammable refrigerants

- Under no circumstances shall potential sources of ignition be used in the searching for or detection of refrigerant leaks.
- A halide torch (or any other detector using a naked flame) shall not be used.

11. Leak detection methods

- The following leak detection methods are deemed acceptable for systems containing flammable refrigerants:
 - Electronic leak detectors shall be used to detect flammable refrigerants, but the sensitivity may not be adequate, or may need re-calibration. (Detection equipment shall be calibrated in a refrigerant-free area.)
 - Ensure that the detector is not a potential source of ignition and is suitable for the refrigerant used.
 - Leak detection equipment shall be set at a percentage of the LFL of the refrigerant and shall be calibrated to the refrigerant employed and the appropriate percentage of gas (25 % maximum) is confirmed.

Important Safety Instructions

- Leak detection fluids are suitable for use with most refrigerants but the use of detergents containing chlorine shall be avoided as the chlorine may react with the refrigerant and corrode the copper pipe-work.
- If a leak is suspected, all naked flames shall be removed/ extinguished.
- If a leakage of refrigerant is found which requires brazing, all of the refrigerant shall be recovered from the system, or isolated (by means of shut off valves) in a part of the system remote from the leak.
- Oxygen free nitrogen (OFN) shall then be purged through the system both before and during the brazing process.

12. Removal and evacuation

- When breaking into the refrigerant circuit to make repairs – or for any other purpose – conventional procedures shall be used. However, for flammable refrigerants it is important that the best practice is followed since flammability is a consideration.

Opening of the refrigeration systems shall not be done by brazing.

- The following procedure shall be adhered to:
 - Remove refrigerant;
 - Purge the circuit with inert gas;
 - Evacuate;
 - Purge again with inert gas;
 - Open the circuit by cutting or brazing.
- The refrigerant charge shall be recovered into the correct recovery cylinders.
- The system shall be “flushed” with OFN to render the unit safe.
- This process may need to be repeated several times.
- Compressed air or oxygen shall not be used for this task.
- Flushing shall be achieved by breaking the vacuum in the system with OFN and continuing to fill until the working pressure is achieved, then venting to atmosphere, and finally pulling down to a vacuum.
- This process shall be repeated until no refrigerant is within the system. When the final OFN charge is used, the system shall be vented down to atmospheric pressure to enable work to take place.

Important Safety Instructions

- This operation is absolutely vital if brazing operations on the pipe-work are to take place.
- Ensure that the outlet for the vacuum pump is not close to any ignition sources and there is ventilation available.

13. Charging procedures

- In addition to conventional charging procedures, the following requirements shall be followed:
 - Ensure that contamination of different refrigerants does not occur when using charging equipment.
 - Hoses or lines shall be as short as possible to minimise the amount of refrigerant contained in them.
 - Cylinders shall be kept upright.
 - Ensure that the refrigeration system is earthed prior to charging the system with refrigerant.
 - Label the system when charging is complete (if not already).
 - Extreme care shall be taken not to overfill the refrigeration system.
- Prior to recharging the system it shall be pressure tested with OFN.
- The system shall be leak tested on completion of charging but prior to commissioning.
- A follow up leak test shall be carried out prior to leaving the site.

14. Decommissioning

- Before carrying out this procedure, it is essential that the technician is completely familiar with the equipment and all its detail.
 - It is recommended good practice that all refrigerants are recovered safely.
 - Prior to the task being carried out, an oil and refrigerant sample shall be taken in case analysis is required prior to re-use of reclaimed refrigerant. It is essential that electrical power is available before the task is commenced.
- a) Become familiar with the equipment and its operation.

Important Safety Instructions

- b) Isolate system electrically.
- c) Before attempting the procedure ensure that:
 - Mechanical handling equipment is available, if required, for handling refrigerant cylinders;
 - All personal protective equipment is available and being used correctly;
 - The recovery process is supervised at all times by a competent person;
 - Recovery equipment and cylinders conform to the appropriate standards.
- d) Pump down refrigerant system, if possible.
- e) If a vacuum is not possible, make a manifold so that refrigerant can be removed from various parts of the system.
- f) Make sure that cylinder is situated on the scales before recovery takes place.
- g) Start the recovery machine and operate in accordance with manufacturer's instructions.
- h) Do not overfill cylinders. (No more than 80 % volume liquid charge).
- I) Do not exceed the maximum working pressure of the cylinder, even temporarily.
- j) When the cylinders have been filled correctly and the process completed, make sure that the cylinders and the equipment are removed from site promptly and all isolation valves on the equipment are closed off.
- k) Recovered refrigerant shall not be charged into another refrigeration system unless it has been cleaned and checked.

15. Labelling

- Equipment shall be labelled stating that it has been de-commissioned and emptied of refrigerant.
- The label shall be dated and signed.
- Ensure that there are labels on the equipment stating the equipment contains flammable refrigerant.

16. Recovery

- When removing refrigerant from a system, either for servicing or decommissioning, it is recommended good practice that all refrigerants are removed safely.

Important Safety Instructions

- When transferring refrigerant into cylinders, ensure that only appropriate refrigerant recovery cylinders are employed.
- Ensure that the correct number of cylinders for holding the total system charge is available.
- All cylinders to be used are designated for the recovered refrigerant and labelled for that refrigerant (i.e. special cylinders for the recovery of refrigerant).
- Cylinders shall be complete with pressure relief valve and associated shut-off valves in good working order.
- Empty recovery cylinders are evacuated and, if possible, cooled before recovery occurs.
- The recovery equipment shall be in good working order with a set of instructions concerning the equipment that is at hand and shall be suitable for the recovery of flammable refrigerants.
- In addition, a set of calibrated weighing scales shall be available and in good working order.
- Hoses shall be complete with leak-free disconnect couplings and in good condition.
- Cylinders shall be complete with pressure relief valve and associated shut-off valves in good working order.
- Empty recovery cylinders are evacuated and, if possible, cooled before recovery occurs.
- The recovery equipment shall be in good working order with a set of instructions concerning the equipment that is at hand and shall be suitable for the recovery of flammable refrigerants.
- In addition, a set of calibrated weighing scales shall be available and in good working order.
- Hoses shall be complete with leak-free disconnect couplings and in good condition.
- Before using the recovery machine, check that it is in satisfactory working order, has been properly maintained and that any associated electrical components are sealed to prevent ignition in the event of a refrigerant release.
- Consult manufacturer if in doubt.
- The recovered refrigerant shall be returned to the refrigerant supplier in the correct recovery cylinder, and the relevant Waste Transfer Note arranged.
- Do not mix refrigerants in recovery units and especially not in cylinders.

Important Safety Instructions

- If compressors or compressor oils are to be removed, ensure that they have been evacuated to an acceptable level to make certain that flammable refrigerant does not remain within the lubricant.
- The evacuation process shall be carried out prior to returning the compressor to the suppliers.
- Only electric heating to the compressor body shall be employed to accelerate this process.
- When oil is drained from a system, it shall be carried out safely.
- This appliance is not intended for use by persons (including children) with reduced physical, sensory or mental capabilities, or lack of experience and knowledge, unless they have been given supervision or instruction concerning use of the appliance by a person responsible for their safety. Children should be supervised to ensure that they do not play with the appliance.
- To keep ventilation openings clear of obstruction.
- The appliance shall be stored in a room without continuously operating open flames (for example: an operating gas appliance) and ignition sources (for example operating electric heater).
- Any person who is involved with working on or breaking into a refrigerant circuit should hold a current valid certificate from an industry-accredited assessment authority, which authorises their competence to handle refrigerants safely in accordance with an industry recognised assessment specification.
- Servicing shall only be performed as recommended by the equipment manufacturer.
- Maintenance and repair requiring the assistance of other skilled personnel shall be carried out by the person competent in the use of flammable refrigerants.
- The pipe-work shall be compliant with national gas regulations.
- The maximum refrigerant charge amount is 0.45kg.
- The installation of pipe-work shall be kept to minimum.

Important Safety Instructions

- If the refrigerant is flammable the dehumidifier equipment shall have red, Pantone® Matching System (PMS) #185 marked service ports, pipes, hoses, and other devices through which the refrigerant is serviced. This colour shall be present at all service ports and where service puncturing or otherwise creating an opening from the refrigerant circuit to the atmosphere might be expected (e.g., process tubes). The colour mark shall extend at least 25 mm (1 inch) from the refrigerant servicing point and shall be replaced if removed



Caution, risk of fire
Avertissement : risque
d'incendie/matériaux
inflammables





WARNING

- Do not use means to accelerate the defrosting process or to clean, other than those recommended by the manufacturer.
- The appliance shall be stored in a room without continuously operating ignition sources (for example: open flames, an operating gas appliance or an operating electric heater).
- Do not pierce or burn.
- Be aware that refrigerants may not contain an odour.

AVERTISSEMENT

- Ne pas utiliser de produits permettant d'accélérer le dégel ou de produits de nettoyage autres que ceux recommandés par le fabricant.
- L'appareil doit être entreposé dans un endroit sans source d'allumage fonctionnant en continu (par exemple : flamme nue, appareil au gaz en marche ou radiateur électrique en marche).
- Ne pas percer ni brûler.
- Attention : les frigorigènes peuvent être inodores.

1.3 Explanation of symbol displayed on the unit.

 <p>Caution, risk of fire Avertissement : risque d'incendie/matériaux inflammables</p>	<p>WARNING</p>	<ul style="list-style-type: none">• This symbol shows that this appliance uses a flammable refrigerant.• If the flammable refrigerant is leaked and exposed to an external ignition source, there is a risk of fire.
	<p>CAUTION</p>	<ul style="list-style-type: none">• This symbol shows that the operation manual should be read carefully.
	<p>CAUTION</p>	<ul style="list-style-type: none">• This symbol shows that a service personnel should be handling this equipment with reference to the installation manual.
	<p>CAUTION</p>	<ul style="list-style-type: none">• This symbol shows that information is available such as the operating manual or installation manual.

SPECIFICATIONS

MODEL	JD026R-150
POWER SOURCE	115V~ 60Hz
TOTAL INPUT CURRENT	7.5A
MOISTURE REMOVAL (65°F, 60%RH)	49.72 PINTS (23.51 L/DAY)
MOISTURE REMOVAL (80 °F, 60%RH)	70 PINTS (33.11 L/DAY)
MOISTURE REMOVAL (86 °F, 80%RH)	120 PINTS (56.76 L/DAY)
MOISTURE REMOVAL (95 °F, 90%RH)	150 PINTS (70.95 L/DAY)
INPUT POWER (65°F, 60%RH)	500W
INPUT CURRENT (65°F, 60%RH)	4.4A
IEF (65°F, 60%RH)	1.9 L/kWh
MOTOR FLA	0.58 A
MOTOR COMPRESSOR(RLA/LRA)	4.3A / 24.9A
REFRIGERANT	R32/150g(5.3oz)
MAXIMUM ALLOWABLE PRESSURE	3.72MPa(540psig)
HIGH PRESSURE	2.07MPa(300psig)
LOW PRESSURE	0.85MPa(123psig)

- The dehumidification capacity is rated at a room temperature of 18.3°C(64.94°F) with a relative humidity of 60%RH.
- If specifications are changed in the future, the product nameplate will reflect the new specifications.
- The working temperature range of this machine is between 7°C(44.6°F) and 32°C(89.6°F).
- If the room temperature is not within this range, the unit will not operate normally.

WARNING

This product can expose you to chemicals including Styrene and its compounds, which are known to the State of California to cause cancer and birth defects or other reproductive harm. For more information, please visit: www.P65Warning.ca.gov.

PRODUCT DIAGRAM

Parts

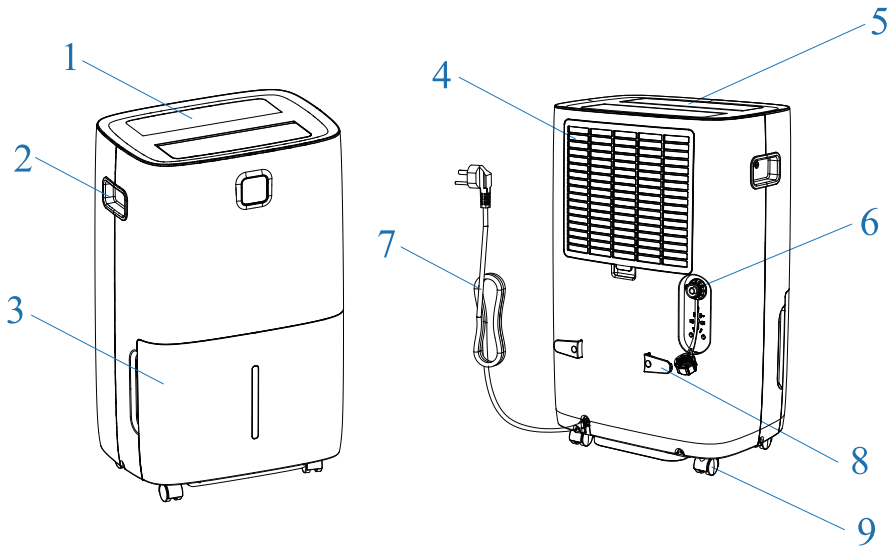

Continuous drainage hose

- | | | |
|------------------|----------------------|----------------------|
| 1. Control panel | 2. Handle | 3. Water bucket |
| 4. Air intake | 5. Air outlet | 6. Drain hose outlet |
| 7. Power cord | 8. Power cord buckle | 9. Caster |

OPERATING INSTRUCTIONS

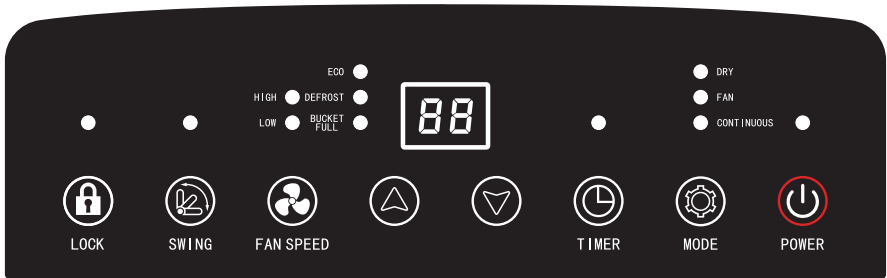



Humidity Level & Timer Display

1. When the machine is powered on, it will indicate the current room humidity.
2. When you set the humidity, it will indicate the humidity that you have set.
3. When you program the timer, it will show the timing duration.
4. When the environment humidity is lower than 25%RH, it will show "25"
5. When the environment humidity is higher than 95%RH, it will show "95"

OPERATING INSTRUCTIONS

When the machine is powered on for the first time, it will buzz the power sound before entering into the standby status.

“  ” **Turn On/Off:**

Press “  ” to start the machine when it is powered off. Press “  ” to turn off it when the machine is operating.



When dehumidifying or drying (continuous) mode, the compressor stops running and the power indicator flashes; in the air supply mode, the power indicator is on.

OPERATING INSTRUCTIONS

FAN SPEED:

Press “” button as follows: You can press this button to adjust the fan speed between low and high level. The corresponding indicator light will turn on when the fan speed is set.

Humidity Setting:

Humidity Setting: Press “” or “” to t preset your desired humidity level. The humidity is adjustable between 30%RH to 80%RH in 5%H increment. The default humidity is 40%RH. When the humidity reaches the setting, the compressor stops and the "ECO" LED lights up.

MODE Setting:

Press “MODE” to switch the working modes as follows: Press “” to switch the working mode among DRY, CONTINOUS and FAN mode. When the mode is set, the corresponding mode indicator light will turn on.

TIMER Setting:

Press  button to set a timer:

(1) In the standby state, press the timing button to set a timer to automatically start the machine. The timing light will turn on, and the display will initially show the timing at 1.0. Press "UP" or "DOWN" to adjust the timer. In the timing process, you can press the timing button again to cancel it.

(2) In the power-on state, press the timing button to set a timer to automatically shut down the machine. The clear display will show the timing at 1.0. Now, Press "UP" or "DOWN" to adjust the timer.

(3) The timing range is 1-24h.

(4) Press and hold the timer button for 3 seconds to turn off the front display

DRAINAGE

“” SWING Setting:

Press the “” button and the swing light will turn on. The fan blades will move up and down 40~80 degrees. Press the button again to stop the blades immediately.

“” LOCK Setting:

After long pressing the timing button for 3 seconds, the lock key function is turned on, the lock light is on and the other keys are invalid after the lock key. Only after pressing the timing button again for 3 seconds to cancel the lock button function, will the other keys will be effective after the lock lamp is off.

MANUAL DRAINAGE

Emptying the Water Tank

When the water tank is full, the tank full indicator light “ ● ” will turn on, and the dehumidifier will stop automatically. The buzzer will beep 15 times to remind you to empty the water tank.

1. Gently press the sides of the tank with both your hands and pull the tank out.
2. Pour out the collected water.
3. Install the water tank steadily into the machine.

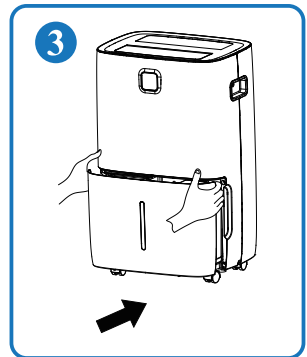
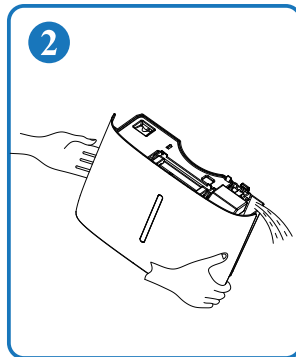
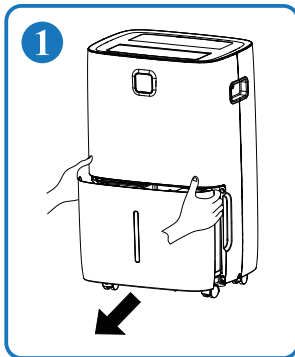

DRAINAGE

NOTE

1. Do not remove the float from the water tank. The full tank sensor will no longer be able to detect the water level correctly without the float and water may leak from the tank.

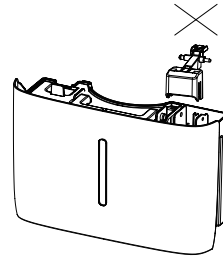

2. If the tank is dirty, please wash it with cold or lukewarm water. Do not use detergent, scouring pads, chemically treated dust cloths, gasoline, benzene, thinner, or other solvents, as these may scratch and damage the tank and cause water leakage.

3. When replacing the tank, please press the tank firmly into place with your both hands. If the tank is not positioned properly, the “TANK FULL” sensor will be activated, and the dehumidifier will not operate.

CONTINUOUS DRAINAGE

1. Unscrew the outlet cover on the back of the machine.
2. Insert the drain hose (included) and make sure the hose is secure so there are no leaks. Then the dehumidifier will continuously drain water.

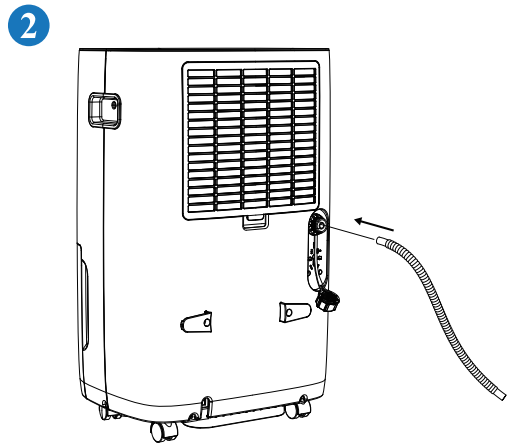
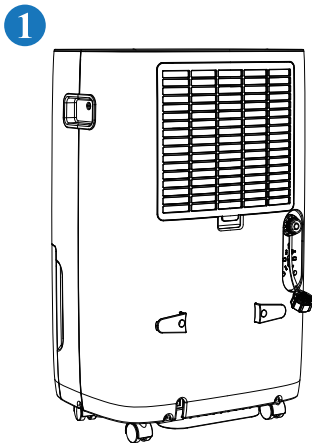

DRAINAGE

CONTINUOUS DRAINAGE (WITH NORMAL DRAINAGE HOSE)

The drainage hose has to be assembled smoothly like Fig.1.

The hose cannot be distorted or has substantial turning. The hose cannot be higher than the water outlet. Keep the hose not blocked. Do not use extension tubes or replace it with other different hoses.

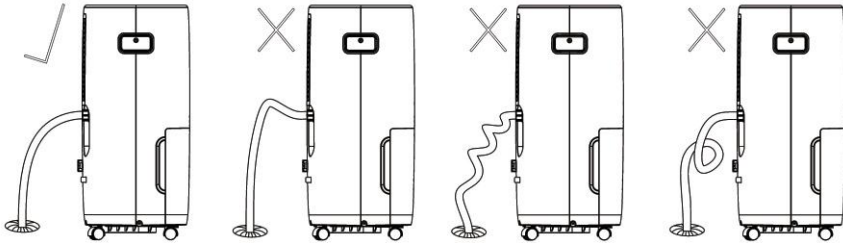

(Fig.1)

MAINTENANCE & CLEANING

Cleaning the Dehumidifier

To Clean the Machine

Wipe it with a soft damp cloth.

Cleaning the Air Filter

1. Open the inlet grill firstly and wash with water

2. Clean the air filter

Run a vacuum cleaner lightly over the surface of the air filter to remove dirt. If the air filter is exceptionally dirty, wash it with warm water and a mild cleanser and dry thoroughly.

3. Attach the air filter

Insert the filter into the grill smoothly

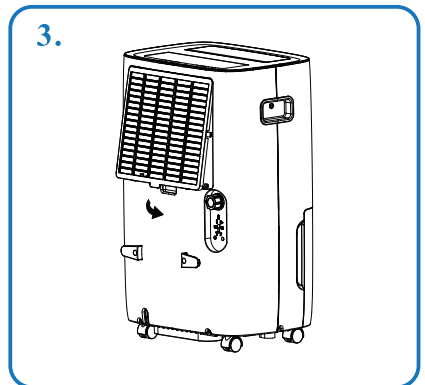
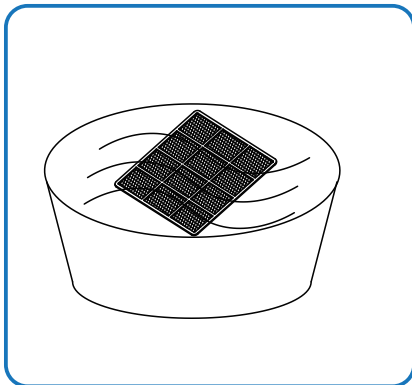
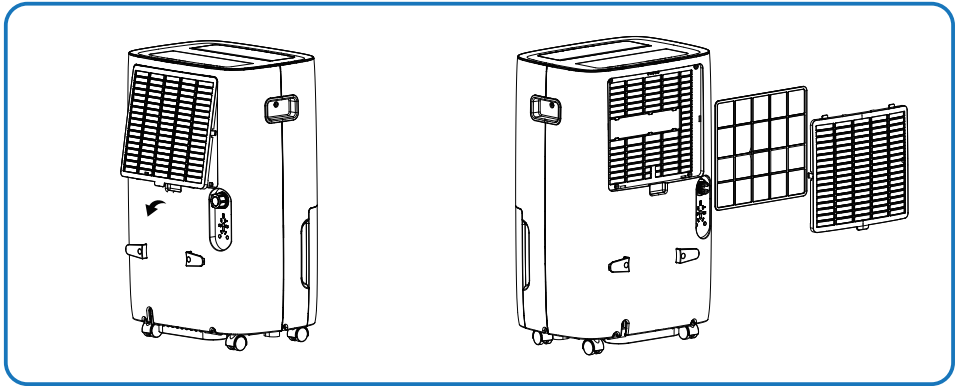

TROUBLESHOOTING

If a condition listed below occurs, please check the following items before calling customer service.

Problems	Possible Causes	Solutions
The unit doesn't operate	Has the power cord been disconnected?	Plug the power cord into the outlet.
	Is the tank full indicator flashing? (The tank is full or in a wrong position.)	Empty the water in the drainage tank and then reposition the tank.
	Is the temperature of the room above 32°C(89.6°F) or below 7°C(44.6°F)?	The protection device is activated and the unit cannot be started.
The dehumidifying function doesn't work	Is the air filter clogged?	Clean the air filter as instructed under "Cleaning the dehumidifier".
	Is the intake duct or discharge duct obstructed?	Remove the obstruction from the discharge duct or intake duct.
No air is discharged	Is the air filter clogged?	Clean the air filter as instructed under "Cleaning the dehumidifier".
Operation is noisy	Is the unit tilted or unsteady?	Move the unit to a stable, sturdy location.
	Is the air filter clogged?	Clean the air filter as instructed under "Cleaning the dehumidifier".
According to "E1"	Abnormal exhaust hose temperature sensor	Check exhaust hose temperature sensor and related circuit.
According to "E2"	Coil temperature sensor abnormal	Check coil temperature sensor and related circuit.
According to "EH"	Humidity sensor anomaly	Check humidity sensor and related circuit.

SPECIAL NOTES



- 1 When using the machine, please do not put it on a soft or uneven ground to prevent vibration and movement.



- 2 Do not insert any thin rods or hard items into the machine to prevent malfunctions and dangers.

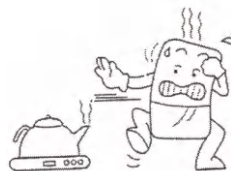

- 3 When using the machine, please keep it away from any heating furnaces, electric kettles and other heating sources.

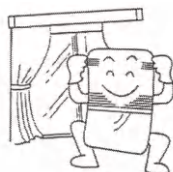

- 4 When using the machine, please close doors and windows for the optimal moisture removal effect.



- 5 Please do not put any objects around the machine. The dehumidification effect will be affected if the ventilation is bad.



- 6 Please unplug the machine from the power source if you do not use it for a long time.



- 7 When cleaning the machine, please use wet cloth to wipe gently. Do not spray water on it directly.

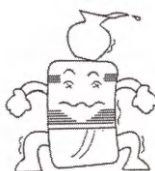

- 8 Please do not put any objects on the dehumidifier.



- 9 Please clean the filter every two weeks. Do not use hot water above 104°F, alcohol, gasoline or toluene.



- 10 When using the hose to drain continuously, please place the hose horizontally and make sure it is even and not winded.



- 11 After cleaning the filter, please do not dry it under direct sunlight to prevent it from deforming.



- 12 Before moving or carrying the machine around, please empty the water tank first.

WARRANTY & CONTACT US

Warranty

Yaufey offers a 12-month warranty to all of our products together with the original proof of purchase when a defect occurred, including those newly purchased and unused, from Yaufey or through an authorized reseller, wholly or substantially, or as a result of faulty manufacturing parts, or workmanship during the Warranty Period.

The warranty does not apply if damage is caused by other factors, including but without limitation of:

- (a) Normal wear and tear;
- (b) Abuse, mishandling, accident or failure to follow operating instructions;
- (c) Exposure to liquid or infiltration of foreign particles;
- (d) Servicing or modification of the product other than by Yaufey.

There are our general terms for the warranty service, but we always encourage our customers to contact us if any issues, regardless of warranty terms.

If you are experiencing an issue with Yaufey product, you can reach out to us at support@yaufey.com, we will dedicate our efforts to resolve it for you.

Extend Your Warranty by 1 Year

Register your product at www.yaufey.com to extend your 1-year warranty by an additional year.

*Please fill out all required fields and include your Order ID, Date of Purchased if applicable.

Customer Support

If you have any questions or concerns about our product, please feel free to contact our expert support team. Yaufey customer service is ready to help.

Yaufey Office

805 Victory Trail Rd, Gaffney, SC 29340 USA

Email: support@yaufey.com

Live Chat: www.yaufey.com

Support Hours

24 Hours available

*Please have your Order Number ready before contacting customer support.

YAUFEY

For FAQs and more information please visit:
www.yaufey.com



@yaufey



@yaufey



@yaufey



@yaufey



(Scan the QR Code for Live Chat)

We are expecting to see our products fulfill your life and hear your voice.

Your satisfaction means a lot to us.

Please tag us if you share a snap on your social media.

www.yaufey.com