





Chrysmela
FASHION FREEDOM

**Wear your favorite earrings
with confidence everyday with Chrysmela,
the world's most secure earring back**

Chrysmela is the only earring back that automatically fits, locks and lifts all types of earrings. Made in the same high-tech factories in Japan that manufacture smartphone camera parts, Chrysmela's patented technology uses three micro ball bearings to lock your earrings into place.

Replace all types of conventional backs with
just one pair of Chrysmela, and you'll
never have to worry about losing an earring again.

 chrysmela.com
 info@chrysmela.com
 [chrysmela](https://www.instagram.com/chrysmela)





Chrysmela Catch is available in Platinum, 24K Gold, and Rose Gold.

Chrysmela Extra features a wider disc to lift heavier earrings, support delicate lobes, and straighten uneven piercings. Chrysmela Extra is also available in the trio of colors.

All of our earring backs are **hypoallergenic**. The patented internal mechanism, made with surgical stainless steel, can support up to 17 pounds. Our Gold and Platinum coatings are 99.9% in purity.

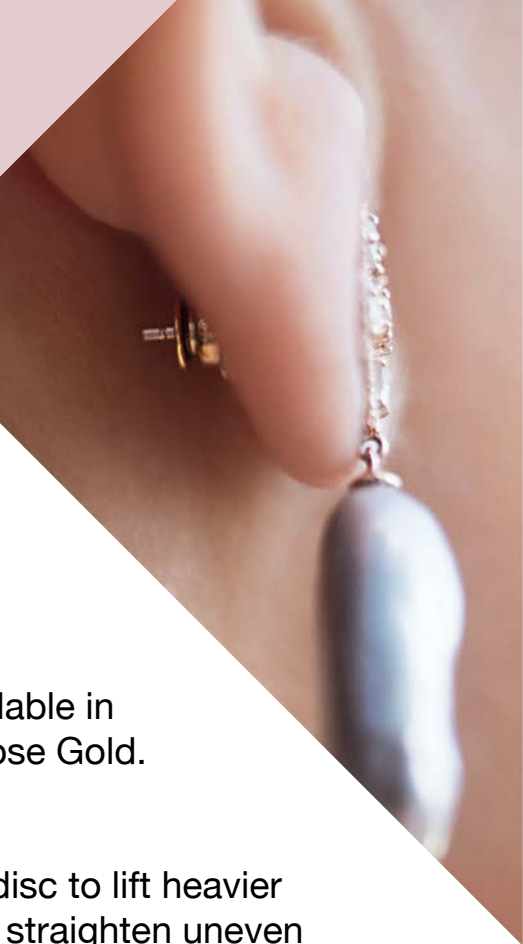
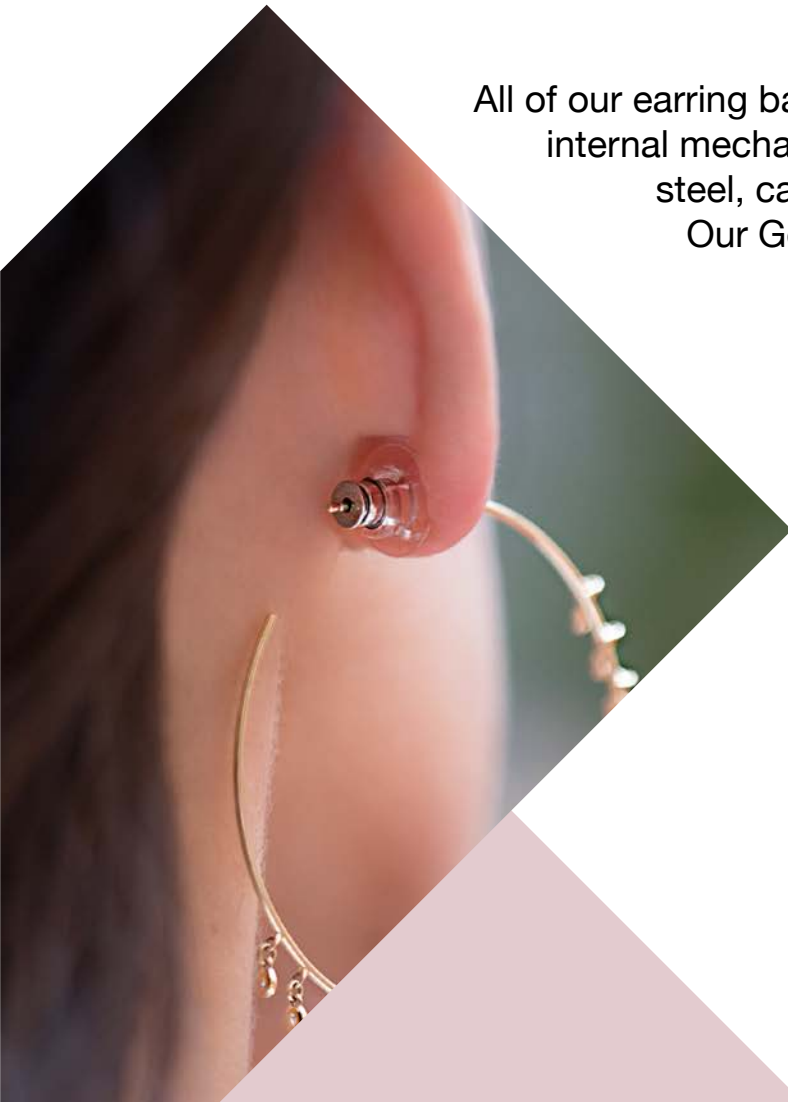

🌐 chrysmela.com
✉ info@chrysmela.com
📷 [chrysmela](https://www.instagram.com/chrysmela)

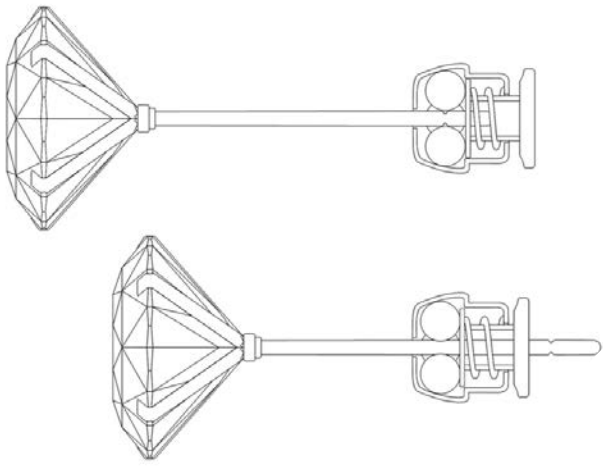

About Chrysmela

Eri Kikunaga invented Chrysmela in 2008 after she lost an earring she received as a gift from her then-boyfriend. They got in a big fight because of the loss and broke up. Eri then vowed to solve the 5,000-year-old problem of lost earrings once and for all.

Eri gained inspiration from the three-point contact system in mechanical pencils that is spring activated to hold the lead in place. The concept worked on paper. But finding a manufacturing partner was an unexpected challenge. Two hundred high-tech manufacturers said NO; it was too difficult to make with the level of precision required. Manufacturing company Number 201 said YES, and a leading market product was born.

Chrysmela currently works with several factories in Japan that produce elements of smartphone cameras we use every day. These precision factories create the interior mechanism that automatically and perfectly locks all types of earring posts from 0.6 to 1.1mm in diameter, the widest size range in the industry today. Patented in the US, UK, France, Italy and Japan, Chrysmela Catch has protected over 1 million earring sets.



Mayumi Ishii

Mayumi Ishii is the US based executive for Chrysmela. Her background began in management consulting at McKinsey & Company, where she worked for three years in both Tokyo and LA. Following McKinsey, she was an equity research analyst at major banks covering high tech in Silicon Valley. A veteran entrepreneur, Mayumi subsequently ran her own international consulting firm, MIV Consulting, where she has helped Silicon Valley startups form strategic alliances with large Japanese companies.

In 2018, Mayumi won an entrepreneur's contest on MSNBC gaining Chrysmela two appearances on Home Shopping Network. Mayumi currently lives in Los Angeles with her husband who shares her passion for golf. They have the goal to play all Top 100 golf courses in the world. Only 10 more to go!

🌐 chrysmela.com

✉ info@chrysmela.com

📷 [chrysmela](https://www.instagram.com/chrysmela)



Chrysmela
FASHION FREEDOM

In the next two years, our goal is for Chrysmela to be on one in 10 earrings. We bring fashion freedom and help people upgrade their special earrings to everyday status.

Chrysmela was invented by a woman to solve the 5,000-year-old problem of lost earrings.

Chrysmela is in sync with the KonMari method. Chrysmela eliminates the need for dozens of earring backs. Declutter your jewelry box to gain confidence that you'll never again worry about losing an earring.

Chrysmela makes a thoughtful gift for anyone who loves earrings.

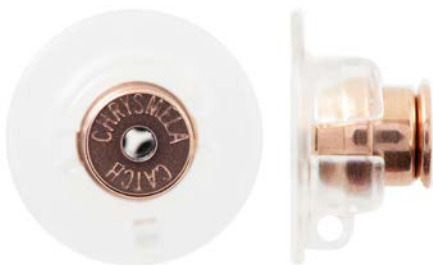

🌐 chrysmela.com

✉ info@chrysmela.com

📷 [chrysmela](https://www.instagram.com/chrysmela)