

PK = PINK

OR = ORANGE

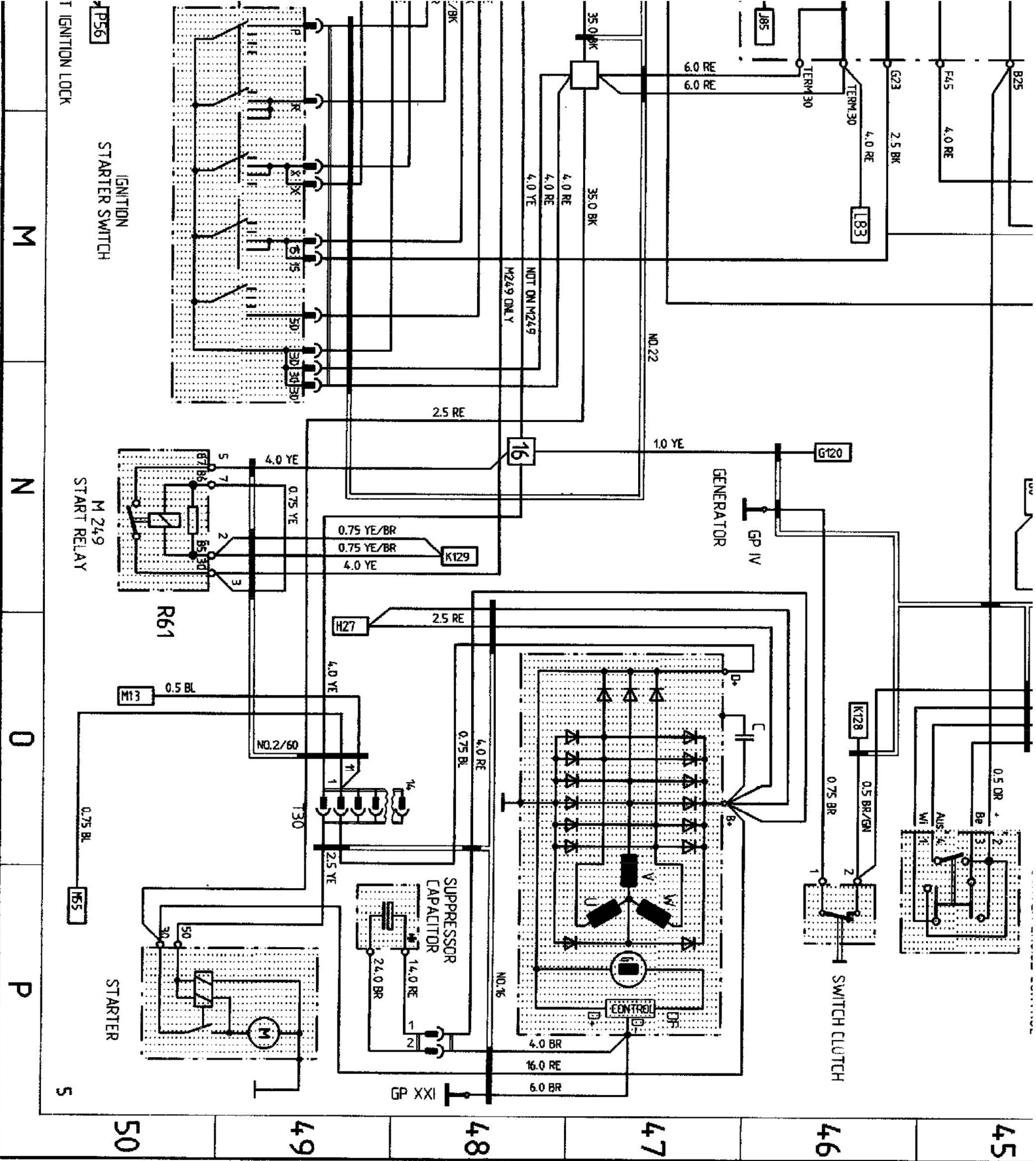

P56

IGNITION
STARTER SWITCH

M 249
START RELAY

R61

STARTER

GENERATOR

SWITCH CLUTCH

SUPPRESSOR
CAPACITOR

CONTROL

M

N

O

P

S

50

49

48

47

46

45

A

B

C

D

E

41

42

43

44

45

DME CONTROL UNIT
55 PIN PLUG

- 46
 - 12
 - 44
 - 7
 - 26
 - 52
 - 53
 - 30
 - 45
 - 31
 - 8
 - 47
 - 48
 - 11
 - 42
 - 19
 - 29
 - 28
 - 10
 - 51
 - 24
 - 14
 - 17
 - 35
 - 15
 - 34
 - 33
 - 16
 - 21
 - 50
 - 41
 - 40
 - 6
 - 22
 - 32
 - 55
 - 13
 - 3
 - 18
- CONTROL HEATER/AC
COND. BLOWER
HIGH PRES.-LOW PRES.-SWITCH
TO
K
L
TERM.30

PRESSURE SENSOR

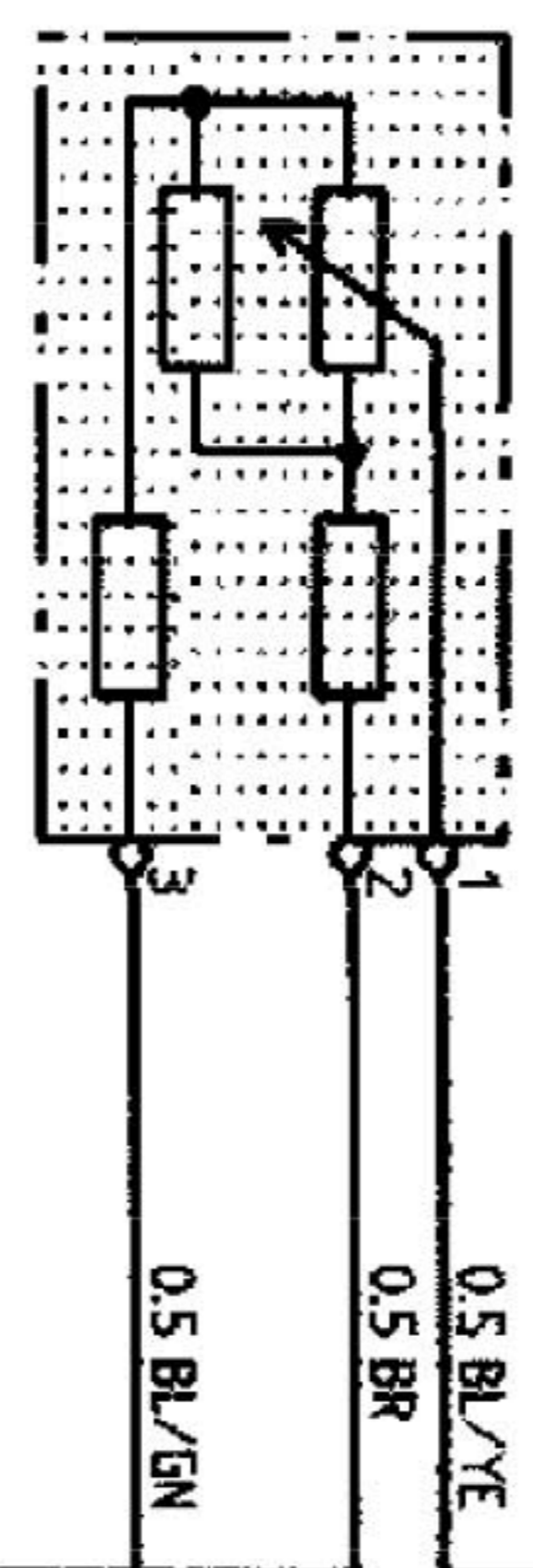

AIR FLOW SENSOR

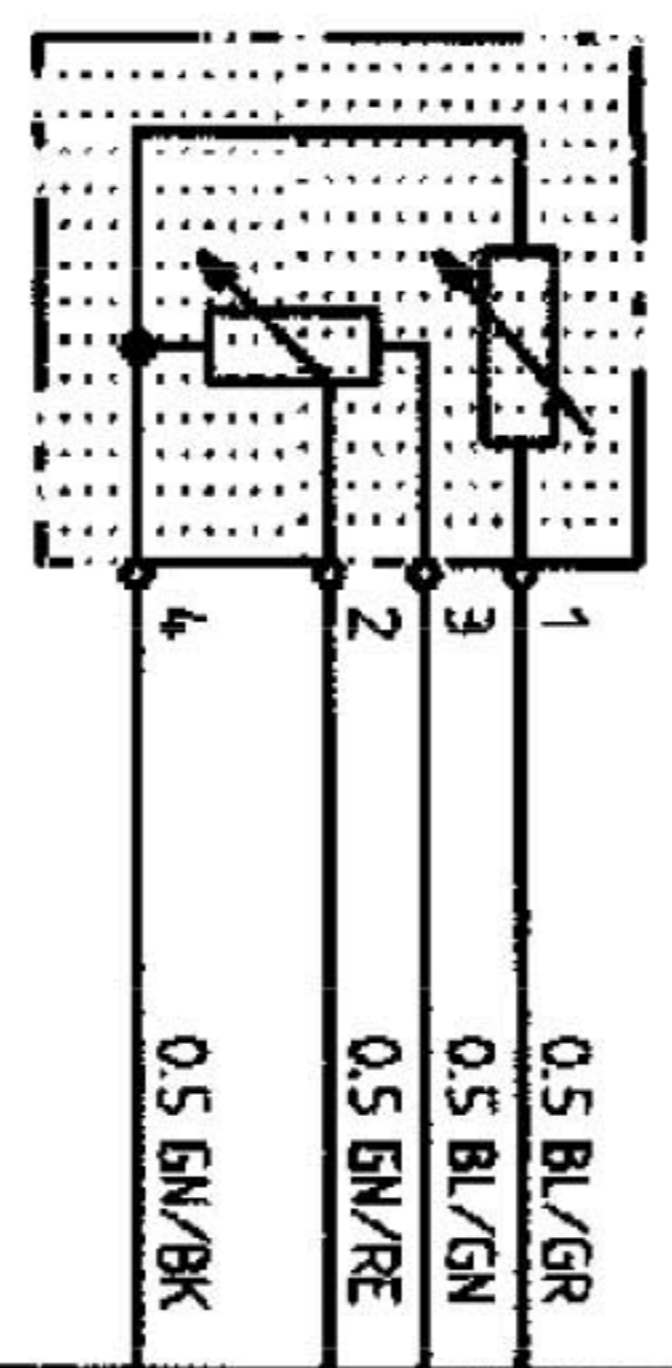

IDLE SPEED THROTTLE
VALVE SWITCH

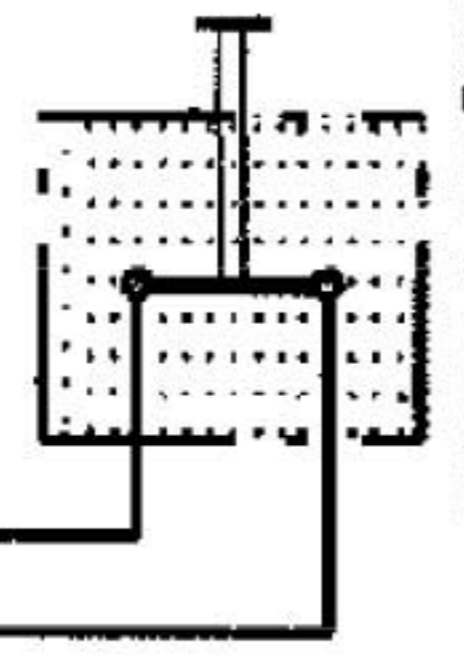

NOT M249

FULL LOAD

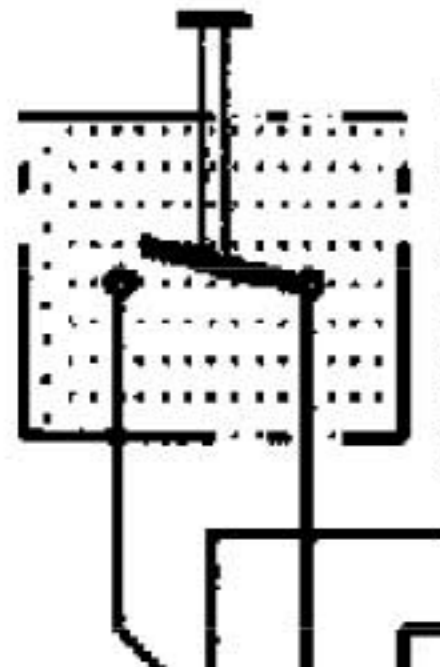

NTC TEMPERATURE
RESISTOR SWITCH

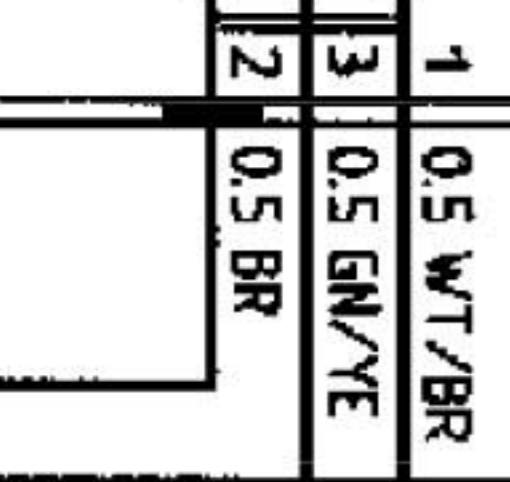

1.5 BR

3

NOT M249

0.5 BR

1.5 BR

0.5 WT

1.0 GN

2.5 BR

6

2.0 BR

2.5 BR

1.0 BR/BK

1.0 BR/RE

1.0 BR/GR

1.0 BR/YE

1.0 BR/GN

1.0 BR/BL

0.5 YE

0.5 BK/GN

0.5 GN/BL

0.5 WT/OR

0.5 BK/VI

0.5 GN/GR

0.5 WT/GN

0.5 OR/WT

0.5 OR/BL

0.5 BK/WT

1.5 RE

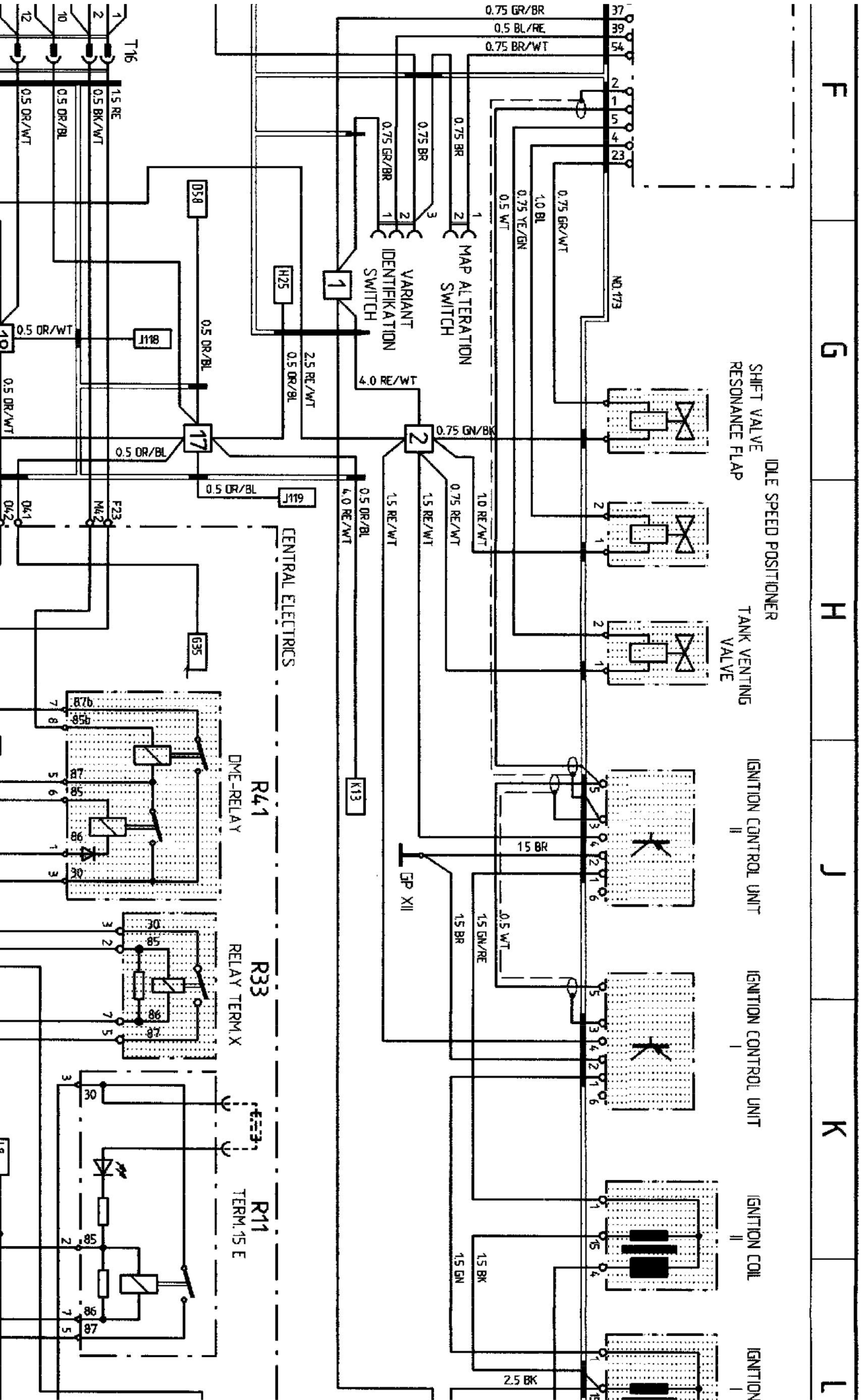

M

N

O

P

COIL

SPARK PLUGS

DISTRIBUTER

CRUISE CONTROL (M454)

DRIVE CRUISE CONTROL

CONTROL UNIT CRUISE CONTROL

SWITCH CRUISE CONTROL

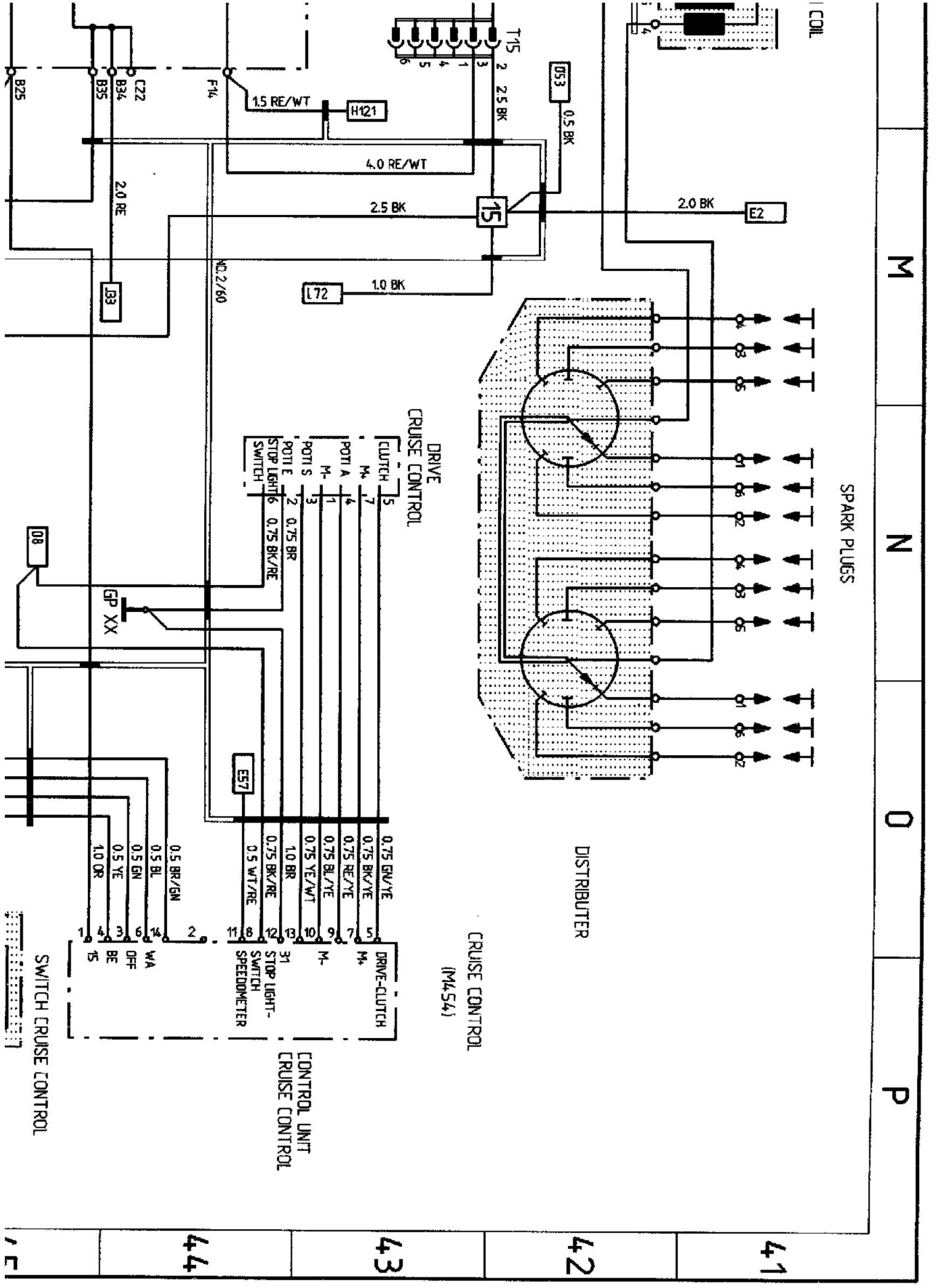

4-1

4-2

4-3

4-4

4-5