

DE

DK

EN

ES

FI

FR

IT

JP

NL

NO

PL

SE

CN^{SI}

CN^{TR}

APP

Bellman® Audio Mino

Personal Amplifier, BE2030

Introduction

Thank you for choosing products from Bellman & Symfon.

Bellman Audio is an assistive listening system. The system consists of a number of units which facilitate listening under different circumstances. Bellman Audio products make everyday life easier for many people and give them the freedom to freely pursue their interests.

The flexible battery charging ensure that the products can be used safely and easily throughout the world.

Read through the entire user manual before starting to use the product. Refer to the diagram showing the accessories and connection options.

Important safety instructions

- Read these Instructions.
- Keep these Instructions.
- Heed all Warnings.
- Follow all instructions.
- Do not use this apparatus near water.
- Clean only with a dry cloth.
- Do not block any of the ventilation openings. Install in accordance with the manufacturers instructions.
- Do not install near any heat sources such as radiators, heat registers, stoves, or other apparatus (including amplifiers) that produce heat.
- Do not defeat the safety purpose of the polarized or grounding - type plug. A polarized plug has two blades with one wider than the other. A grounding type plug has two blades and a third grounding prong. The wide blade or the third prong are provided for your safety. When the provided plug does not fit into your outlet, consult an electrician for replacement of the obsolete outlet.
- Protect the power cord from being walked on or pinched particularly at plugs, convenience receptacles, and the point where they exit from the apparatus.
- Only use attachments/accessories specified by the manufacturer.
- Unplug this apparatus during lightning storms or when unused for long periods of time.
- Refer all servicing to qualified service personnel. Servicing is required when the apparatus has been damaged in any way, such as power-supply cord or plug is damaged, liquid has been spilled or objects have fallen into the apparatus, the apparatus has been exposed to rain or moisture, does not operate normally, or has been dropped.

 **Please note:** The BE2030 Audio Mino Personal Amplifier is not a hearing instrument. Bellman & Symfon recommend that anyone who is experiencing hearing loss should consult a doctor.

 **Warning!** The BE2030 Audio Mino Personal Amplifier has a very powerful amplifier and the sound level can cause discomfort or, in serious cases, endanger hearing if the product is used carelessly. Always turn the volume down to a low level before putting on the headphones!

 **Warning!** The BE2030 Audio Mino Personal Amplifier is powered by rechargeable Lithium-Ion batteries. Do not expose the batteries to fire or to direct sunlight. The batteries must only be changed by Bellman & Symfon staff and must only be replaced by batteries of the same type. There is a risk of explosion if the batteries are not replaced correctly. The batteries must be charged fully before using the products for the first time. Batteries should be charged in temperatures of between +5°C and +40°C.

 **Warning!** The BE2030 Audio Mino Personal Amplifier must only be charged by charging accessories recommended by Bellman & Symfon.

 **Warning!** The AC/DC adapter must not be exposed to water drops or splashes and objects containing liquids, such as vases must not be placed on the unit. To disconnect the power fully, the AC/DC adapter plug must be disconnected from the mains socket. The AC/DC adapter plug must not be blocked and must be easy to access for the intended use. Rating information is shown on the rear of the AC/DC adapter.

 **Warning!** To reduce the risk of fire or electric shock, do not expose this appliance to rain or moisture.

 **Warning!** For the safety of your children - Please be aware that this product may include small parts. Ensure that the package and small parts are kept out of reach of children.



 This symbol indicates that integral electrical equipment must not be treated as household waste. It should be taken to the relevant collection depot for the recycling of electrical and electronic equipment. You can obtain more detailed information about recycling of the product from your local authorities, from the nearest recycling station or from the shop you purchased the product from.

Figure references

- | | |
|---|---|
| <p>1 Internal microphone</p> <p>2 Internal microphone setting LED
<i>Green: Omnidirectional microphone</i>
<i>Orange: Directional microphone</i></p> <p>3 Battery status LED
<i>Green: Switched on with well charged battery</i>
<i>Blinking Green: Switched on but the battery charge is low</i>
<i>Blinking Orange: Switched on with flat battery - will soon switch itself off</i>
<i>Orange: Charging</i></p> <p>4 External sound source input LED
<i>Green: T position</i>
<i>Orange: External mic</i>
<i>Orange and Green: Line in (stereo)</i></p> | <p>5 Button for selecting internal microphone</p> <p>6 On/off button</p> <p>7 Button for selecting T position</p> <p>8 Volume and Tone LED Indicator</p> <p>9 Button for increasing sound level</p> <p>10 Button for reducing sound level</p> <p>11 Button for reducing treble</p> <p>12 Button for increasing treble</p> <p>13 Headphone output 3.5 mm jack plug</p> <p>14 Charging socket</p> <p>15 Clip</p> <p>16 External sound source input 2.5 mm jack plug</p> |
|---|---|

Getting started

Testing

- 1 Connect the Headphones to the headphone output (**13**).
- 2 Give one short press on the On/Off button  (**6**) to start Mino.
- 3 Listen to the internal microphone and adjust the volume using the Volume Buttons (**+** **9** or **-** **10**).

Mino always starts with the internal microphone (**1**) selected as the sound source. In addition, the volume control is always set to low volume to avoid unpleasant sound levels.

The volume control adjusts the sound level by **+** (**9**) raising and **-** (**10**) lowering the volume while the Volume and Tone LED Indicator (**8**) shows the sound level. The more LEDs that are lit, the higher the volume. The LED indicator goes out 5 seconds after the sound volume has been set.

The tone control adjusts the sound quality by **>** (**12**) increasing and **<** (**11**) reducing the treble. The Volume and Tone LED Indicator (**8**) shows the tone setting. The LED indicator goes out 5 seconds after the sound quality has been set.

When you have finished, you can switch off Mino by pressing the On/Off button  (**6**) and holding it down until the Battery Status LED (**3**) goes out.

How to use the Bellman Audio Mino

The BE2030 Bellman Audio Mino Personal Amplifier is a digital communicator which has been specifically developed to provide an exceptional sound experience even in demanding situations. The Bellman Audio Mino works extremely well for speech and music. You can use the built-in microphones or use an external sound source. As an external sound source you can choose an inductive loop, an external microphone or you can connect the Stereo Cable Set to a stereo sound source.

Symbols and indicators

The following symbols are used in the user manual and can be explained as follows:



The warning triangle indicates information which must be followed in order to guarantee operation and also in some cases to ensure personal safety.



The light bulb (tip, note) indicates information which can be useful to help you get the most out of the product.

Charging

Mino is supplied with a built-in rechargeable battery. The battery must be charged before using the product for the first time. Mino contains a Lithium-Ion battery and a universal charger.

 **Warning:** *The product may only be charged with the charger supplied or using accessories from Bellman & Symfon.*

Connect the charger as illustrated in the fold-out section of the manual.

Fit the plug and check that it is locked properly before it is connected to the wall socket. When the charging connector is connected to the Charger and Mino, the Battery Status LED (3) changes from green to orange to indicate that charging is taking place. When charging is finished, after about 4 hours, the LED turns green again.

Function



Connect BE9122 Bellman Stereo Headphones, BE9159 Bellman Neck Loop, BE9403 Bellman Stetoclip, BE9124 Bellman In-ear Phones or another listening product recommended by Bellman & Symfon to the headphone output (13) on the right-hand side as illustrated in the fold-out section of the manual.

Switching on



Press the On/Off button  (6). The Battery Status LED (3) starts to shine with a green light to indicate that the unit is on.

Mino always starts with the internal microphone selected as the sound source. In addition, the volume control is always set to low volume to avoid unpleasant sound levels.

Selecting the sound volume

Use the volume control's  button (9) to increase and the  button (10) to reduce the sound level. The Volume and Tone LED Indicator (8) shows the sound level. The more LEDs that are lit, the higher the volume. The LED indicator goes out 5 seconds after the sound volume has been set.

Selecting the tone

Use the tone control's  button (11) to reduce and the  button (12) to increase the treble in the tone. The Volume and Tone LED Indicator (8) shows the selected setting. The LED indicator goes out 5 seconds after the sound quality has been set.

Switching off

When you have finished, you can switch off Mino by pressing the On/Off buttons  (6) and holding it down until the Battery Status LED (3) goes out.

Choice of microphones

Mino contains two microphone options: one omnidirectional and one directional microphone.

You can switch between omnidirectional and directional microphone reception by pressing the **MIC** button (5). The omnidirectional microphone is indicated by the Microphone LED (2) lighting up green and the directional microphone by it lighting up orange.



With the directional microphone you can "point" towards the sounds source that you are interested in listening to while reducing sound from other directions. This is particularly useful in difficult listening situations, e.g. in crowds or in very noisy environments.

Telecoil/T position

The built-in telecoil is angled at 45 degrees in order to catch inductive signals from an inductive loop both when Mino is in the horizontal position (in the hand or on a table) and in the vertical position (on a clip or neck strap).



The T position can be used in premises where an inductive loop (or hearing loop) has been fitted. Look for the inductive loop symbol or ask staff whether there is an inductive loop if you are unsure. The T position is indicated by the indicator for the external sound source lighting up green.

Selecting the signal source

It is easy to select the sound source.

The user can manually choose between the internal microphone (MIC position) or built-in telecoil (T position) by pressing the buttons **MIC**(5) and **T** (7) on the front. When switching between signal sources, the volume control will be set automatically to a low level to avoid unpleasant sound levels.

Mino automatically selects the input for the external sound source (16) when something is connected. When you remove the connector, Mino will automatically return to the internal microphone (**MIC** position).

External sound source

If the audio cable (which has a small 2.5 mm jack plug on one end) is connected to the external sound source input (16), the internal microphone will be disconnected and the external sound source will be automatically selected. The External Sound LED (4) will light up green and orange at the same time to indicate that the sound is coming from an external sound source.

If the audio cable is disconnected, the sound will be reconnected to the internal microphone again.

With the audio cable connected to a TV, hi-fi equipment, MP3 player or similar sound source, you can listen to absolutely first class stereo sound.

The input sensitivity is automatically adjusted to suit different sound sources.

External microphone

You can connect an external microphone to the external sound source input (16). The External Sound LED (4) will light up orange at the same time to indicate that the sound is coming from an external microphone.

The input sensitivity is automatically adjusted to a suitable amplification when an external microphone is connected.

Combined signal sources

When you are listening via an External Sound Source/telecoil, this sound can be combined with the sound that the internal microphone is receiving.

Choose to listen to the External Sound Source by pressing the **T** button (7). Hold down the **MIC** button (5) until both the MIC LED (2) and T LED (4) light up.

The sound from the external sound source/telecoil is now mixed with the sound from the internal microphone. You can adjust the balance between the external sound/sound from the telecoil and the internal microphone by holding down the **MIC** button (5) at the same time as setting the balance using the **<** (11) or **>** (12) button.

If you want to go back to listening to external sound, press the **T** button (7) and if you want to switch over to listening on the internal microphone, press the **MIC** button (5) instead.

Battery indicator

The Battery Status LED (3) normally lights up green. This indicates that the unit is switched on and the battery level is satisfactory.

When the battery is low, the Battery Status LED (3) blinks green until the battery is almost completely flat when it blinks orange instead. As soon as it blinks green, it is time to charge the unit again. If the unit is not charged, it is switched off automatically.

Charging starts automatically when you connect a charger to the Charging Socket (14). Charging in progress is indicated on the unit by an orange light. Once the battery is fully charged, the indicator changes to green and the battery is continuously trickle charged until the charger is disconnected.

Troubleshooting in brief

Problem	Solution
Nothing happens when you try to start the unit.	<ul style="list-style-type: none">Connect the charger and check that charging starts within 10 seconds. <p> <i>Please note! If charging does not start within 10 seconds, disconnect the charger immediately and contact your nearest dealer!</i></p>
No sound can be heard in the headphones when the unit is switched on.	<ul style="list-style-type: none">Turn up the volume using the volume control + (9).Check that the internal microphone has been selected as the signal source and that it works by gently scraping on the microphones (1).Check that the headphone plug is securely inserted in the headphone output.Connect the headphones to another sound source (with a 3.5 mm headphone output) to test whether the headphones are working.
No sound can be heard in the headphones when the unit is switched on and External Sound is selected.	<ul style="list-style-type: none">Check that the sound source is correctly connected to the unit if the stereo cable is connected to the External Sound Source Input (16).
A high-pitched noise is heard in the headphones.	<ul style="list-style-type: none">Turn down the volume or increase the distance between the microphone and headphones.Direct the microphone away from you.

For further information about the product in English, refer to the Appendix.

Settings

Bellman Audio Mino has more settings than those you can access in user mode. By going into the Settings Menu you can adjust settings that you do not normally need to change or which are adjusted when first used and never need to be changed again.

Settings Menu

How to get into the Settings Menu.

- Start the unit by pressing the On/Off button **(6)**.
- Hold down the On/Off button **(6)** and press down the Volume **—** button **(10)** within 1 second until the T LED **(4)** starts to blink.
- When the T LED **(4)** starts to blink, you can release both the buttons.
- Press and hold down the **T** button **(7)** within 2 seconds of the moment the T LED **(4)** starts to blink.
- Release the **T** button **(7)** immediately once the T LED **(4)** has gone out.

You are now in Balance Control mode.

Overview of the Settings Menu

In the Settings Menu you can switch between the different settings by pressing the **T** button **(7)** or the **MIC** button **(5)**. Each press of the **T** button moves you clockwise on to the next setting in the list and the **MIC** button takes you anti-clockwise to the previous setting in the list.

When you have finished adjusting your settings, give a short press on the On/Off button **(6)** to return to normal user mode.

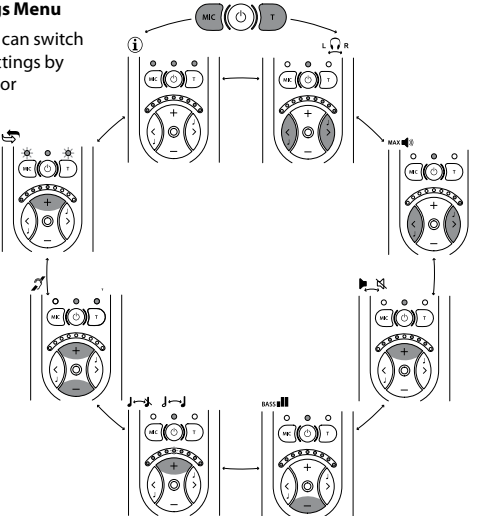

Balance control

The balance between the right and left-hand channels can be set to compensate, for example, for a hearing loss in one ear.

Press the **<** button **(11)** to adjust the balance on the left and the **>** button **(12)** to adjust the balance on the right.

The standard setting is centered balance.



Basic attenuation

Different headphones have different sensitivity levels and you can compensate for this with basic attenuation. What you actually set is the attenuation you require at the maximum power output you want to have (which is therefore 0 dB attenuation). This setting is useful when you want to adjust the maximum volume in user mode for a pair of headphones or in-ear phones with a higher sensitivity than the BE9122 Bellman Stereo Headphones or, for example, if you want to limit the volume for a child.

Use the **>** button **(12)** to reduce the basic attenuation (increase the volume) and the **<** button **(11)** to increase the basic attenuation (reduce the volume). The basic attenuation is adjusted in increments of 3 dB.

The standard setting is 0 dB attenuation, which corresponds to the maximum output signal.



Stereo/Mono

The line-in signal can be rendered in either Stereo or in Mono. The intelligibility of speech can be increased in certain listening situations, such as when watching TV, if the signal is in Mono.

Press the **+** **(9)** button to select Stereo.

Press the **—** **(10)** button to select Mono.

The standard setting is Stereo.



Bass reduction

Low-frequency interference such as fans and road noise can be tiring if you are exposed to it for a long period. By activating bass reduction, low-frequency interference and sounds are reduced.

Press the **+** **(9)** button to select Bass Reduction.

Press the **—** **(10)** button to deactivate Bass Reduction and get level frequency response.

The standard setting is deactivated Bass Reduction.



Adjusting the Tone Control

The Tone Control Blocking function has been developed in case you want to make it easier for the user to use Mino. This setting can be used to choose whether or not the user should be able to adjust the Tone Control. If you choose to switch off the tone control buttons, you can preset the Tone Control that will be used in user mode.



Activation and deactivation of Tone Control in User Mode

Press the **+** (9) button to activate the Tone Control buttons.

Press the **-** (10) button to deactivate them.

The standard setting is Tone Control activated.

Presetting the Tone Control

Press the **<** button (11) and the **>** button (12) to preset the Tone Control to the level that will be used in user mode.

The standard setting is Tone Control centered (level frequency response)



Please note that if the Tone Control is activated, the preset value will be changed as soon as the Tone Control is changed in user mode.



Blocking the T position

The T position can be blocked if you know that the T position will not be used. This setting is for those who will never use the T position and want to avoid selecting this position by mistake.

Press the **+** (9) button to activate the T position.

Press the **-** (10) button to deactivate the T position.

The standard setting is activated T position.



Resetting to the factory setting

You can use this to reset all settings to the standard settings the product was delivered with from the factory.

Press and hold down the **+** button (9) until all the LEDs on the display (8) are lit. After resetting is completed, the display will blink for a short period.



Version information

The product version information is presented here via a pattern of lit and blinking LEDs. This internal information is only intended as an aid for servicing and support.

Testing

It is easy to test Mino yourself. If Mino is not working as described below, you can carry out further troubleshooting as instructed in the Troubleshooting section below.

How to test

The testing of Mino has been divided into three parts. One part for internal microphones, one part for external sound and finally one for charging.

Internal microphones

- Switch on the unit and make sure that the Battery Status LED (3) lights up green.
- Connect the headphones to the Headphone Socket (13) and scrape carefully on the round microphone (1) with your finger and check that there is a scraping sound in the headphones.
- Press the **MIC** button (5) and make sure that the MIC LED (2) changes colour and lights up orange.
- Carefully scrape the small microphone hole on the top (1) and the round microphone (1) with your finger and check that there is a scraping sound in the headphones.
- Press the buttons (9, 10, 11, 12) and check that the Volume and Tone LED indicator changes.

External sound

- Press the **T** button (7) and make sure that the External Sound LED (4) lights up green.
- Hold the unit against an electrical watch with mechanical hands (with built-in battery) and check that it ticks.
- Connect an external sound source to the External Sound Source Input (16) and check that the sound from the sound source is heard in the headphones. The External Sound Source Input (16) can be tested, for example, by connecting a CD player or a radio to the input via a BE9126 audio cable. The unit automatically switches to an external sound source when a connector is connected to the External Sound Source Input (16).

Charging

- Ensure that Mino is switched off.
- Connect the charger to the mains socket.
- Connect the charging cable to both the charger and the unit's charging socket (14), see the fold-out section of the manual.
- Check that the unit's Battery Status LED lights up.

Troubleshooting

Problem	Solution
The sound is louder in one ear than in the other.	<ul style="list-style-type: none"> Adjust the Balance in the Settings Menu.
The sound volume is low even though the volume is set to max.	<ul style="list-style-type: none"> Adjust the Basic Attenuation in the Settings Menu.
The sound is only in Mono even though it is connected via a stereo cable to a sound source which provides stereo sound.	<ul style="list-style-type: none"> Change to Stereo in the Settings Menu.
The bass reproduction is weak.	<ul style="list-style-type: none"> Switch off Bass Reduction in the Settings Menu.
The Tone Control cannot be adjusted.	<ul style="list-style-type: none"> Use the Settings Menu to activate the Tone Control buttons or to adjust the sound.
It is not possible to select T position.	<ul style="list-style-type: none"> Use the Settings Menu to activate the T position.
The unit is acting strangely.	<ul style="list-style-type: none"> Reset the unit to the factory settings in the Settings Menu.
Humming occurs when connecting the stereo cable while charging.	<ul style="list-style-type: none"> Only use the supplied charger.
Interference is heard when used in some environments	<ul style="list-style-type: none"> Move the product away from the suspected source of radio frequency energy, for example a transmitter.

Technical information

Power supply	
Battery power:	Built-in rechargeable lithium-ion battery 3.7 V, 860 mAh
CAUTION <i>Danger of explosion if battery is incorrectly replaced. Replace only with the same or equivalent type.</i>	
Charging device:	5V 1A DC adapter
Operating time:	BE9124 Earphones – up to 30 hours BE9159 Neck Loop – up to 10 hours
Charging time:	~ 4 hours
Input signals	
Microphone:	Built-in electric condenser microphones. (omnidirectional or directional)
Line input:	2.5 mm stereo jack plug, sensitivity 0 dBV (maximum input signal) Automatic selection between line input and external microphone
Telecoil:	Angled at 45° for optimal function horizontally and vertically
Output signals	
Headphone socket:	3.5 mm stereo jack plug
Output power headphone socket:	100 mW at 16 Ω load
Distortion:	
BE9122 Headphones	0.6% THD
BE9124 In-ear phones	0.08% THD
Dynamic range:	90 dB SNR (electrical)
Frequency range:	40-10,000 Hz (electrical)
Max. output level, saturation:	
BE9122 Headphones	124.3 dB SPL (@ 2.5 kHz)
BE9124 In-ear phones	132.0 dB SPL (@ 5 kHz)
BE9403 Stetoclip	145.0 dB SPL (@ 1kHz, 50 mW)

Amplification, full volume
(1 kHz, 60 dB SPL input
signal):

BE9122 Headphones	42.5 dB
BE9124 In-ear phones	55.0 dB
BE9403 Stetoclip	69.7 dB

Amplification, full volume
(60 dB SPL input signal,
HFA):

BE9122 Headphones	46.5 dB
BE9124 In-ear phones	51.5 dB
BE9403 Stetoclip	65.7 dB

Properties

Volume control:	9 increments of 5 dB
Tone control:	+/- 10 dB in 9 increments, cut-off frequency 1.6 kHz
On/Off button:	Clear, countersunk pushbutton
Microphone and T position:	Separate pushbuttons
Combined sound sources:	For mixing external sound and sound from the internal microphone
Balance control (right/left):	0-20 dB programmable reduction in increments of 5 dB
Setting for max. volume:	0-21 dB programmable reduction in increments of 3 dB
Bass Reduction setting:	Lowering of frequencies under 400 Hz by 10 dB
Dynamic compressor:	<ul style="list-style-type: none"> • 10 channels • Dynamic amplification 0-35 dB • Compression 3:1 • Expansion 1:1.5 • Attack time 20 ms <3kHz, 25 ms ≥3kHz • Recovery time 110 ms <3kHz, 200 ms ≥3kHz

Dynamic noise reduction: 10 channel adaptive noise reduction

Feedback handling: Adaptive feedback reduction

Digital signal processing: 22,050 kHz sampling frequency
16-bit resolution in stereo

Additional information:

- Stereo/Mono setting
- Resetting to the factory setting
- Casing designed to reduce contact noise

Additional information

Environmental requirements: For indoor use only

Operating temperature: 0°–35° C, 32°–95° F

Transport and storage temperature: -10°–50° C

Relative humidity: 15%–90% (non condensing)

External dimensions: H × W × D 99 × 48 × 22 mm

Weight: 74 g

Colour: Grey with white front panel and silver-coloured buttons

Regulatory requirements

FCC SDoC: FCC Part 15 Subpart B, CE, RoHS, WEEE, RCM



Accessories

BE9122 Stereo headphones

BE9124 In-ear phones

BE9403 Stetoclip

BE9126 Stereo cable kit, 5 m (16 feet)

BE9127 External microphone, 5 m (16 feet)

BE9159 Neck loop

BE9129 MicroSet

BE9147 Travel case

Measurements

Frequency range (acoustic) (BE9122 Headphones, BE9124 In-ear phones and BE9403 Stetoclip):

Preliminary measurements:

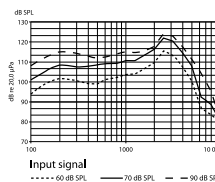

Output signal with BE9122,
Stereo headphones

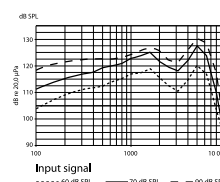

Output signal with BE9124,
In-ear phones

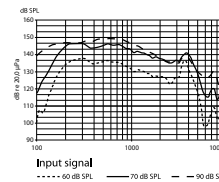

Output signal with BE9403,
Stetoclip

FCC compliance statement

This device complies with Part 15 of the FCC Rules. Operation is subject to the following two conditions: (1) this device may not cause harmful interference, and (2) this device must accept any interference received, including interference that may cause undesired operation.

Warning: Changes or modifications to this unit not expressly approved by the party responsible for compliance could void the user's authority to operate the equipment.

Note: This equipment has been tested and found to comply with the limits for a Class B digital device, pursuant to Part 15 of the FCC Rules. These limits are designed to provide reasonable protection against harmful interference in a residential installation. This equipment generates, uses and can radiate radio frequency energy and, if not installed and used in accordance with the instructions, may cause harmful interference to radio communications. However, there is no guarantee that interference will not occur in a particular installation. If this equipment does cause harmful interference to radio or television reception, which can be determined by turning the equipment off and on, the user is encouraged to try to correct the interference by one or more of the following measures:

- Reorient or relocate the receiving antenna.
- Increase the separation between the equipment and receiver.
- Connect the equipment into an outlet on a circuit different from that to which the receiver is connected.
- Consult the dealer or an experienced radio/TV technician for help.

Statement for Industry Canada

Le fonctionnement de cet équipement est soumis aux conditions suivantes:

(1) l'équipement concerné ne doit pas causer d'interférences, et (2) il doit accepter toute interférence reçue, y compris les interférences risquant d'engendrer un fonctionnement indésirable.

Cet appareil numérique de la classe B est conforme à la norme NMB-003 du Canada.

This Class B digital apparatus complies with Canadian ICES-003.

Accessories

These original accessories are especially developed to maximize the performance of your Mino. Contact your nearest dealer or visit bellman.com

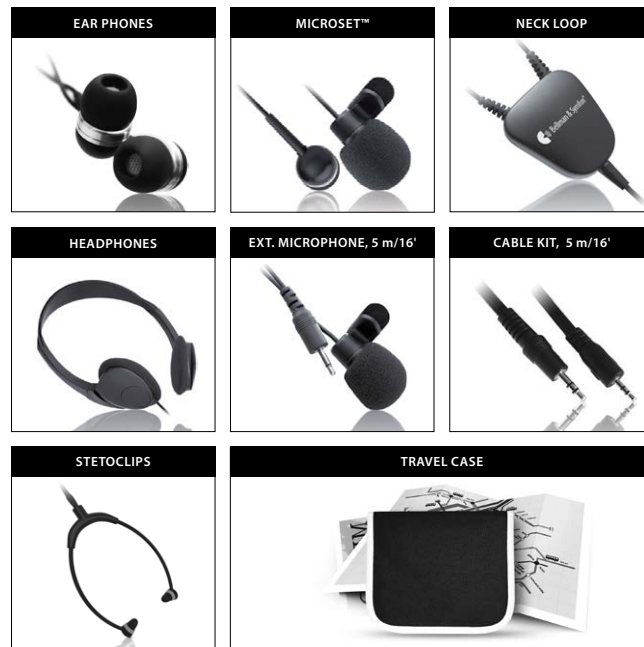

Support centers

Europe
Bellman & Symfon Group AB
Södra Långebergsgatan 30
436 32 Askim, Sweden
Call +46 31 68 28 20
E-mail info@bellman.com

North America
Bellman & Symfon North America Inc.
5509 Business Dr., Unit B
Wilmington, NC 28405, USA
Toll Free: (833) 235-5626

Germany
Bellman & Symfon Deutschland GmbH
Uelzener Str. 14
21335 Lüneburg
Call +49 800 7433338
E-mail info@bellman.de

Asia Pacific
Bellman & Symfon Asia Pacific
1401-06 Main Tower, GD Int'l
Building 339 Huanshi Dong Rd
Guangzhou, China, 510095
Call +86 20 8318 2950
E-mail info.cn@bellman.com

APP

Warranty conditons

Dear customer. Thank you for your purchase of this Bellman & Symfon® product. Our vision is to supply outstanding products that are of great value for our customers. For this reason, we have put all our best efforts into designing and manufacturing this product. However, if you should have any questions about the product or if you require repair, please contact us.

General warranty conditions. Your Bellman & Symfon® product is covered by a limited warranty. Please read the following conditions carefully and keep this information in a safe place. Please also save your receipt or other proof of purchase as you will need this for warranty claims.

Warranty period. The warranty is depending on the type of product purchased and is valid from date of purchase.

Bellman & Symfon offers warranty as per below:

Bellman Products in general	Two years of warranty from date of purchase
Bellman Neckloop	One year of warranty from date of purchase
Rechargeable batteries	One year of warranty from date of purchase
Bellman Accessories	90 days of warranty from date of purchase

Warranty conditions. Bellman & Symfon warrants that the Product that you have purchased is free from manufacturing defects in materials and workmanship when dispatched from our warehouse. Your sales receipt is your proof of the date of purchase and the warranty period commences as of that date. During the warranty period, Bellman & Symfon will have the option for the defective product to be repaired or replaced. The replacement product will be of equal or greater function and in good working and physical order. Such a replacement will be supplied from refurbished stock. The repaired or replaced product will be under warranty for the remainder of the original product's warranty period.

Warranty limitations. This warranty automatically becomes void if the product has been physically damaged or rendered defective (a) as a result of accident, misuse, or abuse, or other circumstances beyond Bellman & Symfon's control; (b) by the use of parts or peripherals not authorized by Bellman & Symfon; (c) as a result of normal wear and tear; (d) by use within an improper operating environment; (e) by modification of the product; (f) by the serial number or product code sticker being removed or defaced; (g) as a result of service rendered by anyone other than a Bellman & Symfon Authorized Service Agent; (h) as a result of the product being operated other than in accordance with Bellman & Symfon Group AB's users manual. Neither does the warranty cover failure due to causes outside Bellman & Symfon's control such as failure in your phone carrier's line service (if applicable) or Acts of God. No warranty is offered for disposable batteries.

Return policies / warranty claim. Please see www.bellman.com