

Dotted line size: 500*400mm

Kräus[®]
www.kraususa.com

**Model No.
KA1US21B**

Undermount Cut-out

Pro Hotline: 516.801.8955
Customer Service: 800.775.0703

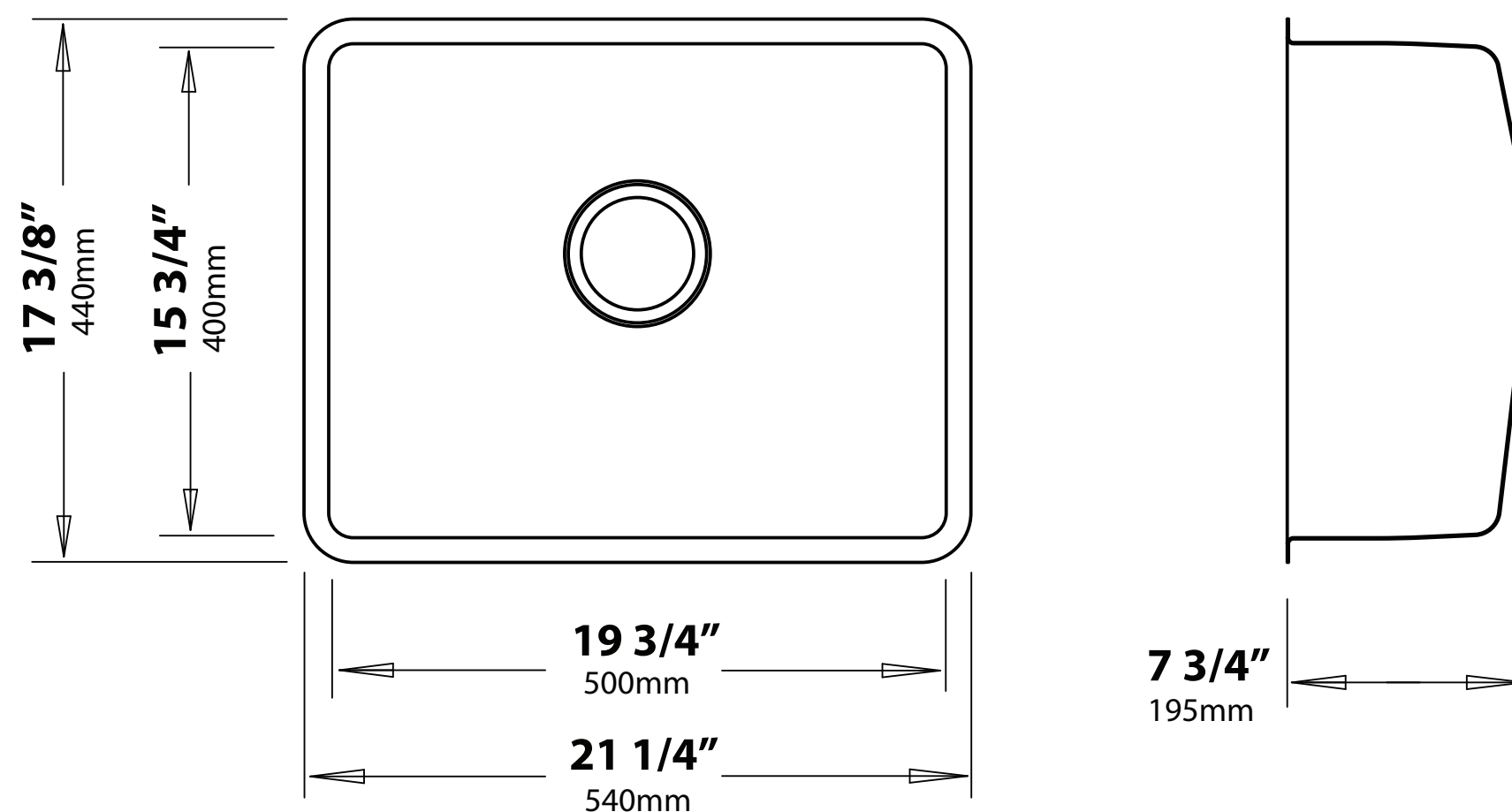

NOTE: Cutout template is provided as a guide **ONLY** and must be checked against actual sink to verify correct fit.

Please cut along inner solid line for negative reveal 1/8" →

Please tear perforated edge for zero / flushed reveal →

Please use outer edge for positive reveal 3/8" →