

# RVH6527

UNDERMOUNT WORKSTATION SINK

**RUVATI**<sup>®</sup>  
SPECIFICATION SHEET

## MATERIAL

True 16 Gauge Thickness  
Premium T304 Grade Stainless Steel  
Nano-PVD colored finish: easy to clean, and long lasting

## FEATURES

- Heavy duty sound guard padding and undercoating
- Slanted bottom with elegant drain grooves for easy draining
- Rounded inside corners

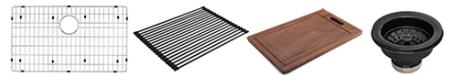

## COLOR OPTIONS

**BL:** Black Stainless Steel

**GG:** Matte Gold Brass Tone

## IN THE BOX

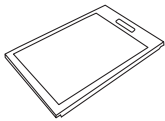

Cutting Board  
[RVA1217AQ]

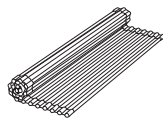

Rollup Rack  
[RVA1385BL / GG]

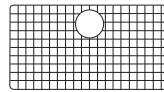

Rinse Grid  
[RVA66527]



Basket Strainer  
[RVA1022BL / GG]

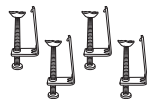

Mounting Clips  
[RVA11042]



Cut-out  
Template

## NOMINAL DIMENSIONS

Exterior: 27" (wide) x 19" (front-to-back)  
Interior Bowl: 25" (wide) x 15-7/8" (front-to-back)  
Bowl Depth: 9"  
Minimum Cabinet Size: 30" wide  
Drain Hole Size: 3½"

Installation Type:  
Undermount

Inside Corners:  
Rounded

Drain Location:  
Rear Center

**RUVATI USA**

www.ruvati.com

Phone: 1.855.478.8284  
Email: support@ruvati.com

# OPTIONAL ACCESSORIES (SOLD SEPARATELY)

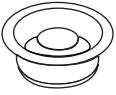

Garbage  
Disposal Flange  
[RVA1041BL / GG]



cUPC certified by IAPMO to meet US and Canada plumbing standards.  
Codes compliance: ASME A112.19.3/CSA B45.4

## DIMENSIONS

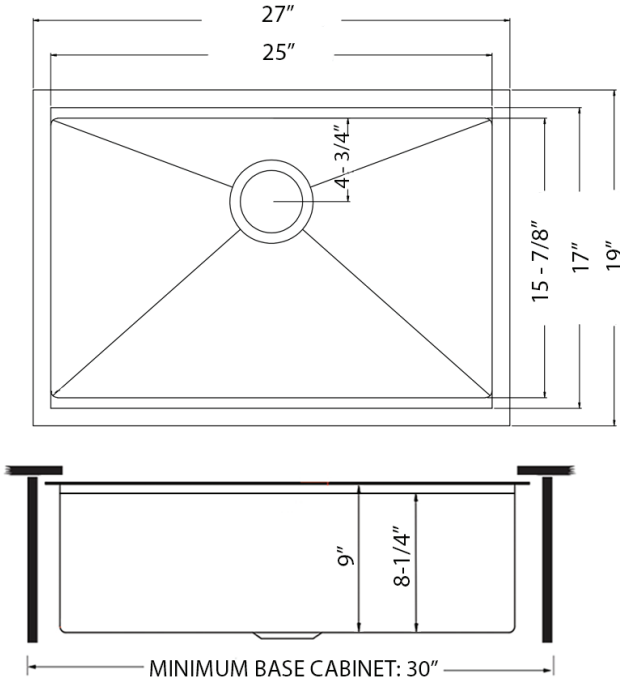

Register your product at [www.ruvati.com/register](http://www.ruvati.com/register).