



PREMIER
COPPER PRODUCTS

MODEL NUMBER: BR16EN2

- * Description: 16" Round Hammered Copper Bar Sink with 2" Drain Opening
- * Outer Dimension: 16" x 7"
- * Inner Dimension: 14" x 7"
- * Rim: 1"
- * Drain Opening: 2"
- * Finish: Nickel

CODE/STANDARD COMPLIANCE

* IAPMO/cUPC LISTED

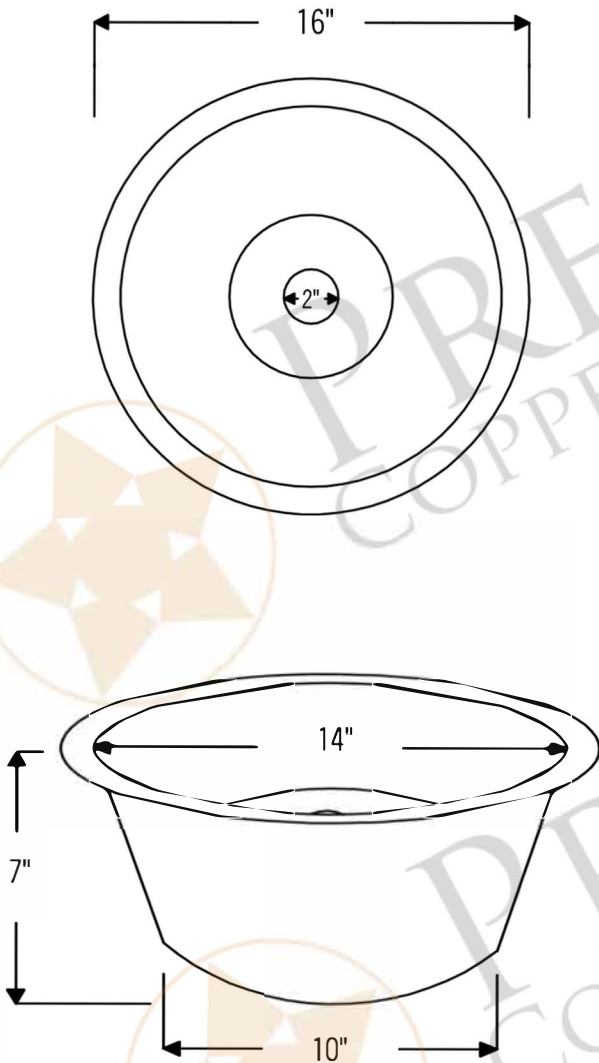

THIS PRODUCT IS HAND CRAFTED, SMALL VARIANCES IN COLOR AND SIZE MAY OCCUR.
DO NOT MAKE ANY INSTALLATION CUTS UNTIL YOU RECEIVE YOUR ITEM(S).