

SOLUTIONS GUIDE 2021



SORINEX[®]
EXERCISE EQUIPMENT

SORINEX EXERCISE EQUIPMENT, INC.

SORINEX.COM
INFO@SORINEX.COM
1-877-SORINEX
193 LITTON DRIVE
LEXINGTON, SC 29073

SPECIFICATIONS AND PRODUCT AVAILABILITY SUBJECT TO CHANGE.
PLEASE SEE THE MOST RECENT VERSION OF OUR CATALOG ON SORINEX.COM

The trademarked logos & wordmarks depicted within the Sorinex Solutions Guide are protected, with all intellectual property rights belonging to the respected schools, institutions, organizations, and teams. Their use herein is not intended for reproduction/sale or to imply endorsement, but merely for illustrative purposes to showcase prior completed works/projects by Sorinex Exercise Equipment, Inc. and the innovative solutions we provide our customers.



1980

"I LEARNED, DESIGNED, AND BUILT EQUIPMENT BECAUSE I HAD VERY LITTLE. WHEN YOU HAVE LITTLE TO WORK WITH, YOU LEARN TO BE CREATIVE." - RICHARD SORIN



2021

I T ' S I N O U R B L O O D

1980 - A school teacher named Richard Sorin was sweating over a hot piece of hand-cut welded steel in a small 2 car garage. He had already taught the scholastic weightlifting club that morning, followed by AM bus duty, 8 hours of gym class, PM bus duty (for extra money that was used to eventually start his business), and then the jogging club for the teaching staff. Following the school day he would tear across town to make it to the steel yard before it closed. He would strap steel to the roof of a 1974 Toyota Land Cruiser and drive back across town to get started with his new business and dream...Sorin Exercise Equipment.

40 years later, Sorinex is still a family owned business and employs more people than ever. Sorinex is the most sought after strength brand for professional teams, colleges, high schools, and military bases. Some of our designs have changed the face of strength training forever, and can be found in most serious gyms worldwide. During this process of growth, our clients have become an extended family to us, part of our brotherhood. We realize we are still around because of our great customers and friends. We want to take the opportunity to thank YOU, our customers, supporters, vendors, and friends for being the foundation on which Sorinex is built. Without you, there is no Sorinex. We promise to do our best to serve you with the best strength training equipment and service in the industry.



RICHARD "POPS" SORIN
FOUNDER / OWNER



BERT SORIN
PRESIDENT / CO-OWNER

OVER 40 YEARS OF SKIN IN THE IRON GAME

THE RISK

POPS MORTGAGES HIS HOUSE FOR KENTUCKY JOB WHICH BECAME THE BIGGEST CUSTOM WEIGHT ROOM IN NATION.

BRANDED

COMPANY RENAMED TO SORINEX EXERCISE EQUIPMENT®.

BUILT TO LAST

PRIOR TO A 13-0 SEASON, INSTALLED MIAMI HURRICANES FOOTBALL WEIGHT ROOM. PIVOTAL TO CANES SUCCESS, SORINEX THEN INSTALLED FIRST PORTABLE WEIGHT ROOM AT THE ROSE BOWL FOR THE NATIONAL CHAMPIONSHIP GAME.

DEBUT

SUMMERSTRONG™ 1

RECOGNITION

BASEFIT™ / BASE CAMP™ SYSTEMS WITH FIRST EVER 4-WAY HOLE DESIGN RELEASED AT CROSSFIT GAMES 2.

MODERNIZATION

SORINEX JAMMER ARMS™ RELEASED. FIRST EVER RACK ATTACHED LEVER ARMS.

AWARDED

SORINEX IS AWARDED HALF OF THE LARGEST FITNESS CONTRACT IN HISTORY, THE U.S. ARMY ACFT KITS.

THE REWARD

SORINEX PAVES THEIR WAY TO BECOMING THE INDUSTRY LEADER IN QUALITY AND INNOVATION WITH MAJOR INSTALLS AT AUBURN AND PENN STATE.

TRADITION

SUMMERSTRONG™ 10

1980

1987

1989

1992

1999

2001

2004

2007

2008

2009

2010

2013

2016

2017

2020

AFTER MAKING THE BIGGEST CUSTOM WEIGHT ROOM IN THE NATION, BRUNO PAULETTO AT THE UNIVERSITY OF TENNESSEE DEMANDED ONE LARGER AND "BETTER". POPS DELIVERED, CREATING THE FIRST SUPER ROOM.

THE CHALLENGE

RICHARD SORIN STRIKES HIS FIRST SPARKS. SELF TAUGHT WELDING AND DESIGN. SORIN EXERCISE EQUIPMENT FOUNDED.

FOUNDED

DEVELOPMENT

NEW HQ IN IRMO, SC SHOWING GROWTH AND PROGRESS.

INNOVATION

SORINEX CREATES FIRST "LANDMINE", CREATED OUT OF A TRAINING NEED FOR BERT WHILE PREPARING FOR OLYMPIC TRIALS IN HAMMER THROW.

BASE CAMP™ RACK EARLY ADOPTERS:
 - NICK GARCIA (NOTRE DAME HS)
 - CRAIG FITZGERALD (USC FOOTBALL)
 - LUKE RICHESSON (JACKSONVILLE JAGS)
 - TOM MYSLINSKI (MEMPHIS)

ESTABLISHED

EXPANSION

UPGRADED HQ AND MANUFACTURING FACILITY IN LEXINGTON, SC.

40+ YEARS IN BUSINESS WITH 40+ INDUSTRY FIRST DESIGNS TO DATE.

LEGACY

O U R P R O C E S S



"THE LIGHTBULB MOMENT WAS WHEN WE WERE TRYING TO GET EVERYONE ELSE TO DO WHAT SORINEX DOES AND THEY JUST COULDN'T DO IT." - COACH JASON PULLARA

C U S T O M D E S I G N

Since 1980, Sorinex has designed and built custom innovative training solutions of the highest standard. Custom isn't just picking your logos and colors. To us, custom means a hand-built solution from start to finish. Every situation is unique. We start by asking the right questions to co-create a one of a kind solution for each client. Because most of our products are made to order, fabrication time varies depending on the product scope. Our design process begins with a strong understanding of your needs and vision. Together, with your dedicated Solutions Specialist and CAD Designer, we analyze and brainstorm various concepts to ensure maximum potential. We will bring your concept to reality through a series of in-person and remote planning sessions where you will have the opportunity to view your room in 3D digital renders and virtual reality.

M A N U F A C T U R I N G



BUILT TO LAST A LIFETIME

Since 1980, our premise has been simple: Make functional strength training equipment that could be customized, and above all, BOMB PROOF. Sorinex equipment is backed by an industry leading LIFETIME STRUCTURAL WARRANTY.



AMERICAN CRAFTSMANSHIP

A simple look to ancient building techniques can and does give the answer of how to make things 'simple but strong'. Proven for thousands of years. No slots or 'cutting corners'.



U.S. MADE RAW MATERIALS

Built better because we have to. We build our equipment to the standards that we hold true to ourselves. We strive to source American Made raw materials and components whenever possible.



QUALITY CONTROL

We ensure proper fit-and-finish from the first step in production to the last 1" Cold Rolled Steel Bolt tightened at installation.



PRECISION LASER TECHNOLOGY

From complex branding elements to our iconic numbered tubing. Our one-of-a-kind components are expertly crafted with our Precision Laser Technologies.

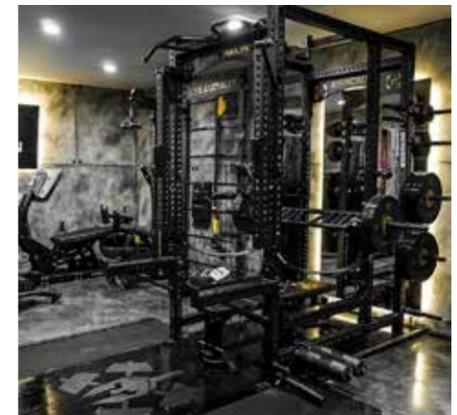

PROTECTED INVESTMENT

We are always creating and improving. With consistent yearly innovation, improved intelligent design, and increasing functionality, we are the category leader in design and modular adaptability.

I N S T A L L



We are dedicated to providing the highest level of customer satisfaction. We ensure proper fit-and-finish with every install. Every thought, design, weld, and detail is brought to reality during this process. Your Solutions Specialist will be present to ensure our LEGENDARY standards. Whether it is new construction, remodel, or simple replacement, we work directly with architects, builders, and administration to ensure satisfaction.

S U P P O R T



Unlike most companies, our support does not end once the install is finished. Annual safety checks, equipment training, coaching consultations, and consistent visits are all included in the Sorinex package. When we say "Bosco Brotherhood", we mean it. This is a family business, and to us, that means being here to support you and your program.

P R O M O T E



In 2020, the digital media landscape is moving faster than ever. Proper branding, promotions, visual media, and messaging are key to stand above the crowds. We are a fully staffed media organization with the tools and social reach to create, support, and promote your efforts. Recruiting athletes, coaches, and clients to your program is our specialty. We are prepared to create industry leading video, photography, 3D imaging and VR/AR experiences to enhance your communities' understanding of who you are and the value you bring.

PROFESSIONAL

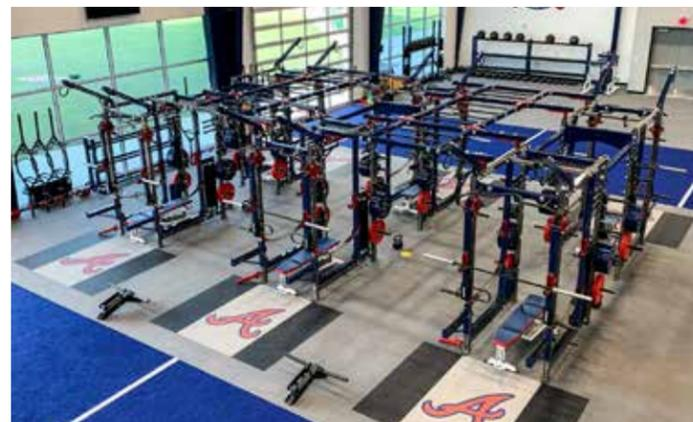

COLLEGIATE

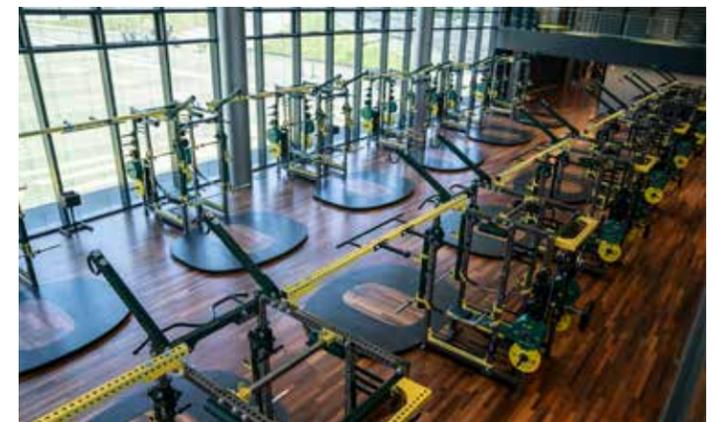

HIGH SCHOOL



MILITARY

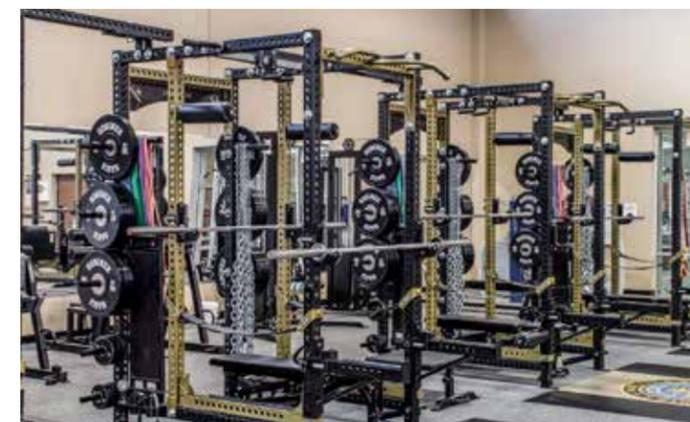
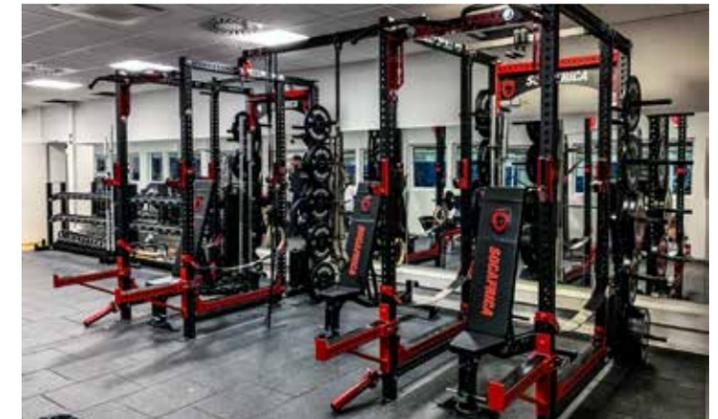

PRIVATE TRAINING

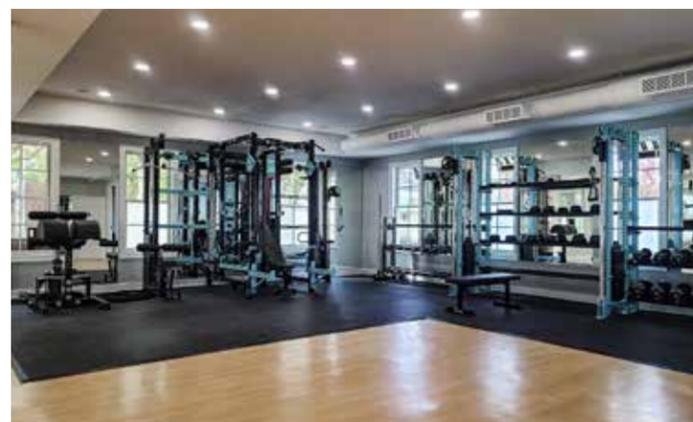

HOME FACILITY

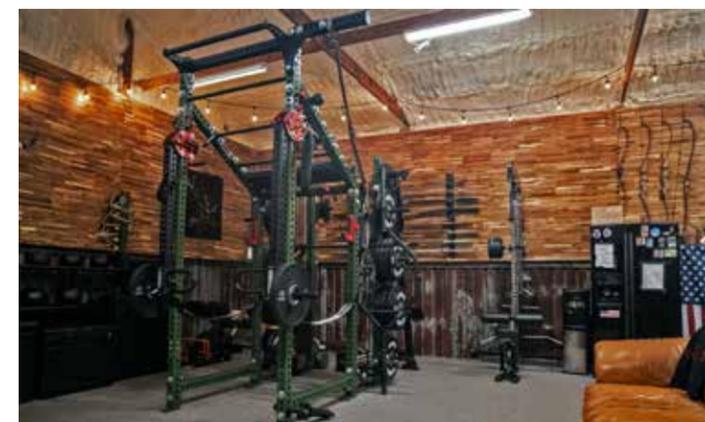
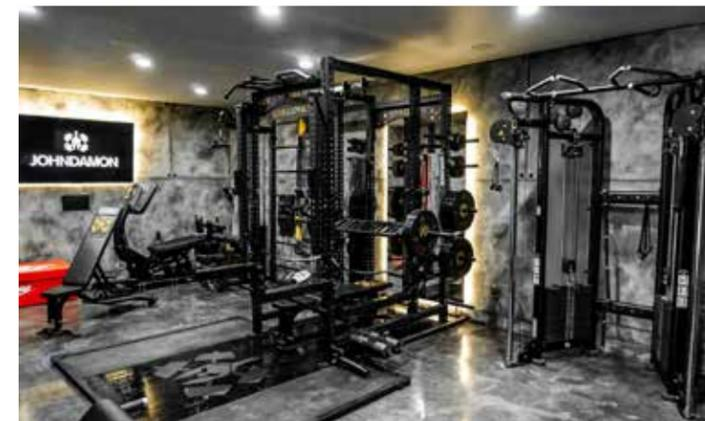
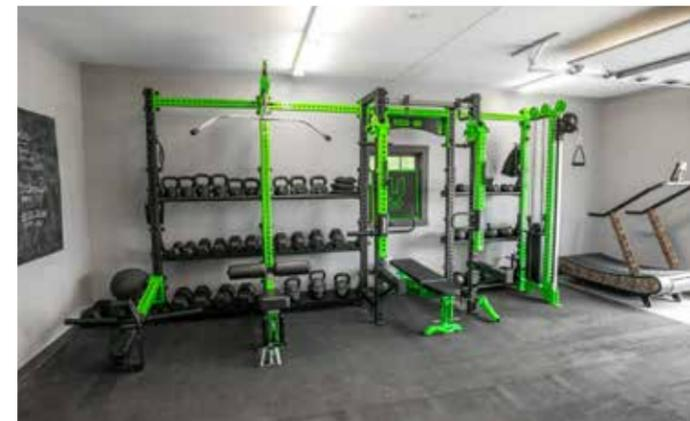



RACKS

Designed to maximize the versatility of your space, our racks provide the most training options per square foot. Sorinex racks are American made by professionals for professionals, and are built to last a lifetime.

THE BASE CAMP™ SERIES

THE MOST VERSATILE RACK ON THE MARKET

The Sorinex Base Camp™ rack is our premier rack offering, made by professionals for professionals. The Base Camp rack design and name represents the start of your training journey. An industry first 4-way hole design boasts 1,768 total holes offering limitless training opportunities. Built with expansion in mind, not replacement. As you grow, the Base Camp rack grows with you via new attachments, customizable storage, bridges, and outriggers. Long gone are the days of wasted iron and dollars simply because of changing training philosophies. The Base Camp rack is the most versatile rack ever created. Allowing more people than ever to train at one station, increasing the carrying capacity of your facility. The configurations and adjustments are endless, easily adaptable to your training program. Forever changed is the world available to strength practitioners.



NUMBERED HOLES



SANDWICH STYLE J-HOOK



SAFETY STRAP SYSTEM



BATWING CHIN BAR



CUSTOM LOGO ARCH



CUSTOMIZABLE STORAGE

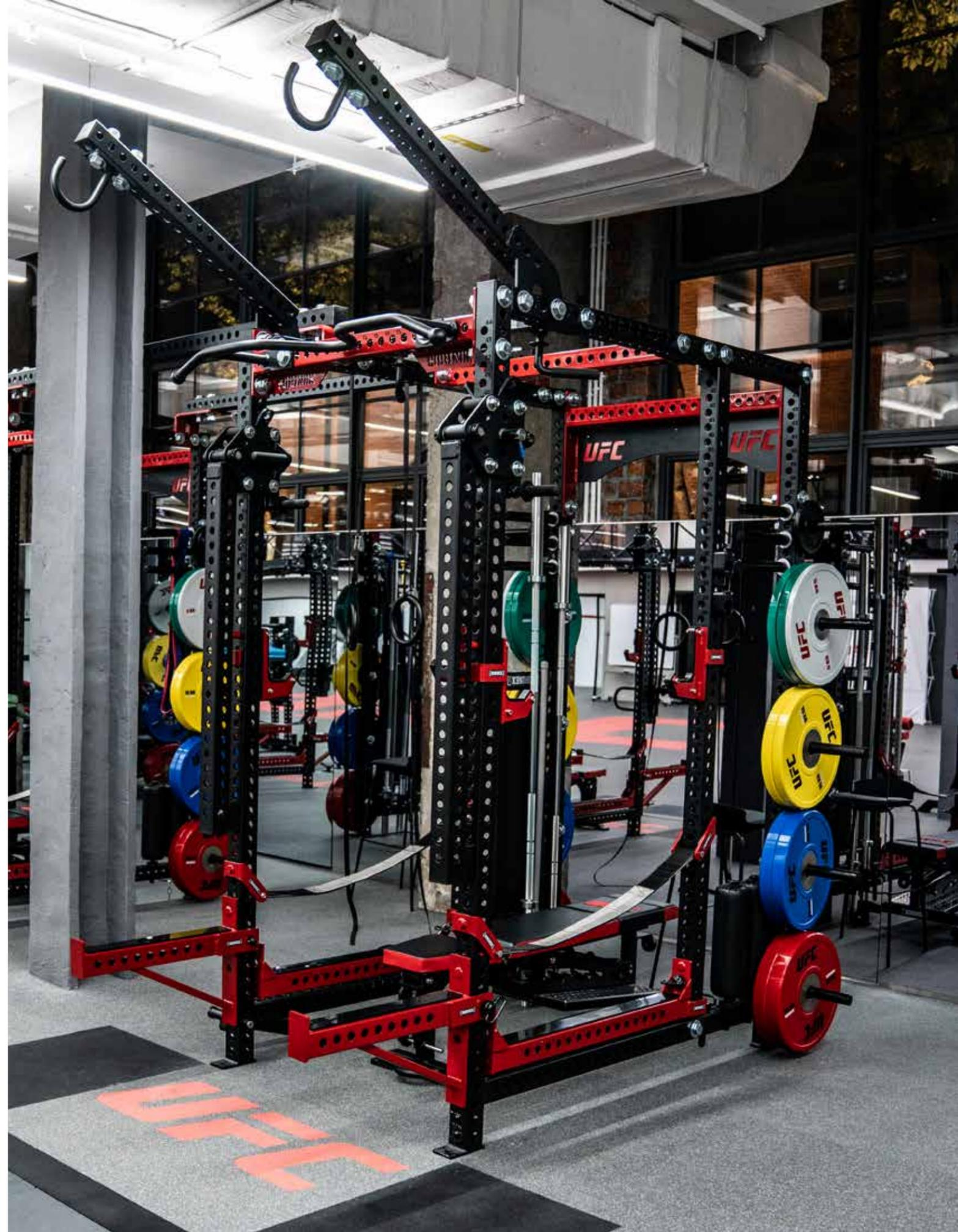



HALF RACK

TUBING	3" x 3"
DEPTH	64"
WIDTH	47"
HEIGHT	101.62"
WEIGHT	422 LB
NUMBERED HOLES	YES
MATERIAL	11 GAUGE OR 7 GAUGE STEEL



SINGLE RACK

TUBING	3" x 3"
DEPTH	53.5"
WIDTH	47"
HEIGHT	101.62"
WEIGHT	328 LB
NUMBERED HOLES	YES
MATERIAL	11 GAUGE OR 7 GAUGE STEEL



POWER RACK

TUBING	3" x 3"
DEPTH	74.5"
WIDTH	47"
HEIGHT	101.62"
WEIGHT	561 LB
NUMBERED HOLES	YES
MATERIAL	11 GAUGE OR 7 GAUGE STEEL



DOUBLE HALF RACK

TUBING	3" x 3"
DEPTH	74.5"
WIDTH	47"
HEIGHT	101.62"
WEIGHT	657 LB
NUMBERED HOLES	YES
MATERIAL	11 GAUGE OR 7 GAUGE STEEL



RACK AND A HALF

TUBING	3" x 3"
DEPTH	100.88"
WIDTH	47"
HEIGHT	101.62"
WEIGHT	778 LB
NUMBERED HOLES	YES
MATERIAL	11 GAUGE OR 7 GAUGE STEEL



DOUBLE FULL RACK

TUBING	3" x 3"
DEPTH	104.88"
WIDTH	47"
HEIGHT	101.62"
WEIGHT	837 LB
NUMBERED HOLES	YES
MATERIAL	11 GAUGE OR 7 GAUGE STEEL

UBER PACKAGE UPGRADE



LANDMINE



UTILITY SEAT



TWO BAR / UTILITY SEAT STORAGE



ROLLER PADS



INDEXING CHIN



HALF SPOTTER BARS

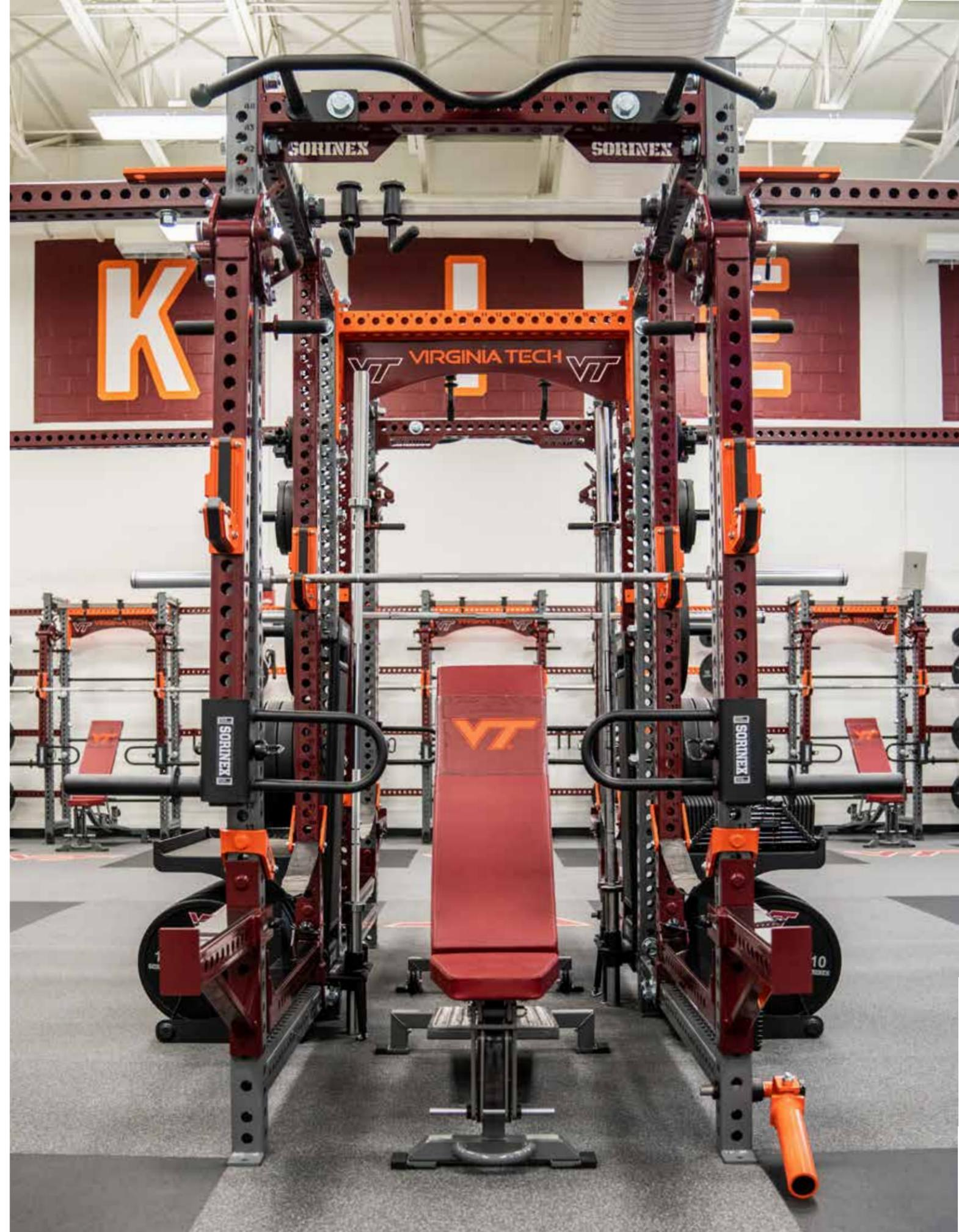

THE ARMORED BASE CAMP™

The Armored Base Camp™ rack features unrivaled versatility, training solutions, and storage capacity per square foot.

FEATURES



DUAL 300 LB WEIGHT STACKS



HI/LO CABLE PULLEY SYSTEM



4-WAY RACK ACCESS



ARMOR PLATES



MULTI-STORAGE WINGS



2" FAT GRIP KNURLED CHIN BAR



THE BASE CAMP 4 X 4™

The Base Camp 4 x 4™ is a heavy duty rack made for the big men in the trenches.



TUBING	4" x 4"
DEPTH	75.25"
WIDTH	48"
HEIGHT	101.375"
MATERIAL	11 GAUGE STEEL

OFF-SET J-HOOK

*PATENT PENDING

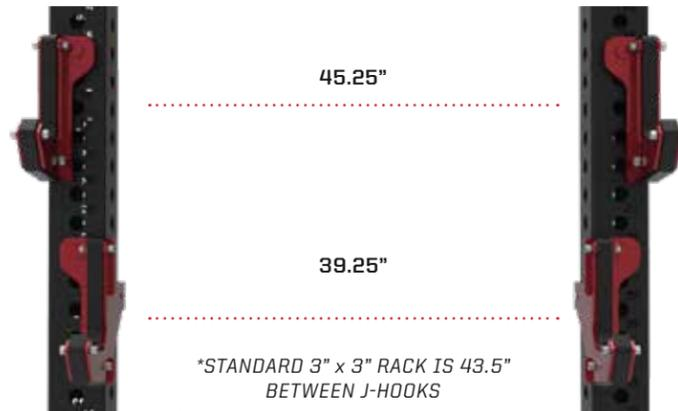

FOLDING RACK SAFETY BARS

*PATENT PENDING



INTEGRATED SECONDARY J-HOOK

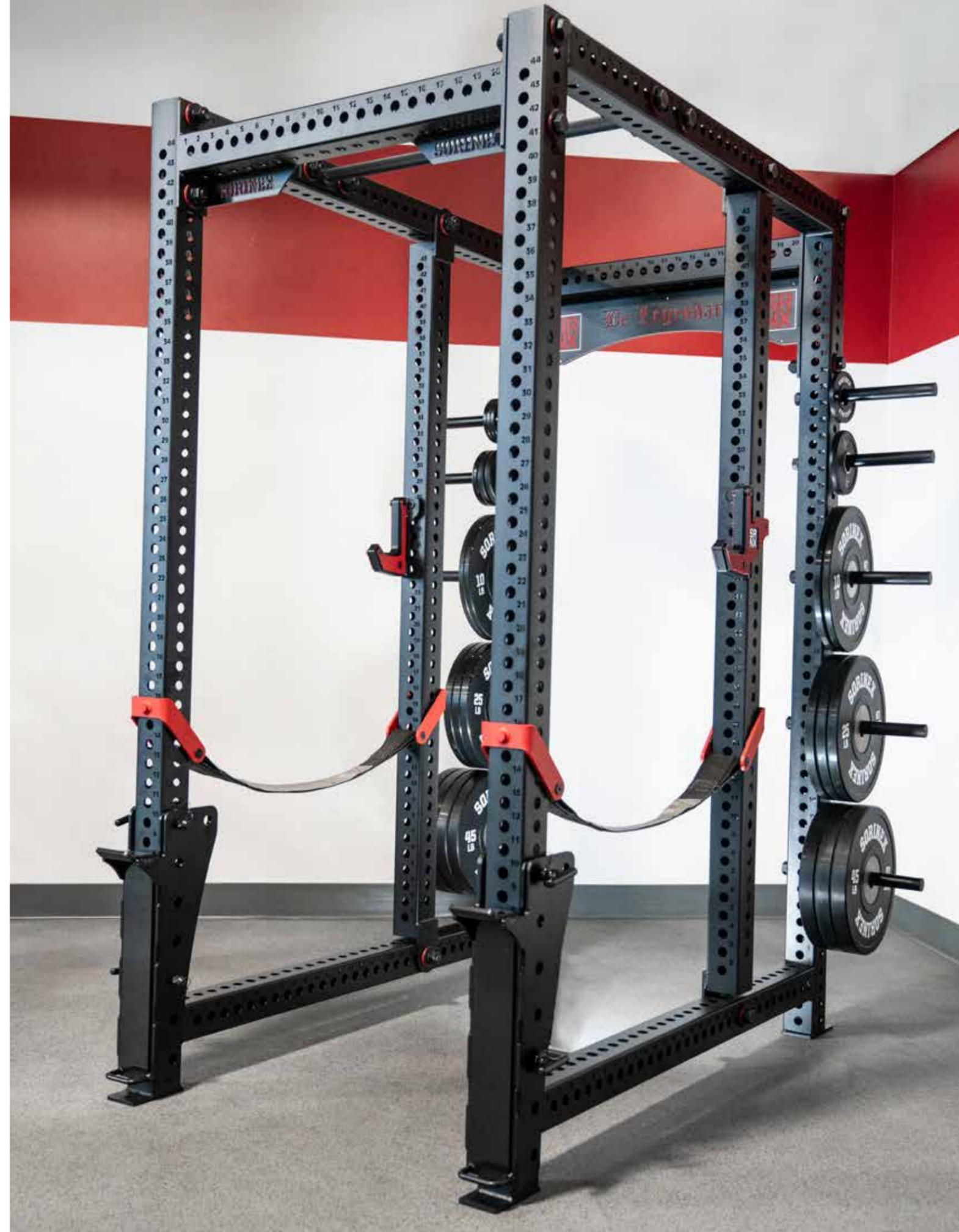



THE XL™ SERIES

THE OPTIMAL SOLUTION

Custom made to fit any scenario, the XL Series rack is the evolution of our original Base Fit rig series. Originally titled "Base Fit XL" as we moved from 2" to 3" steel components, the Base Fit rig was the genesis of the modern day rig with modular pieces that are customizable to fit any space or application. All copies and other 4-way hole racks and rigs are based off this design. Today, the XL Series racks and rigs offer an optimized solution for the demands of modern strength coaches and athletes. High schools, colleges, and home gym owners look to the XL Series racks and rigs for an extremely high return on their investment. Expand or adjust as your program evolves. Custom branding options give you the look of our Base Camp rack series without the cost. Created with the same quality and dedication to innovative training solutions that you have come to expect from Sorinex.



XL STYLE J-CUP



SAFETY STRAP SYSTEM



SINGLE CHIN



DOUBLE CHIN



SINGLE BAR STORAGE



XL SERIES STORAGE





HALF RACK

TUBING	3" x 3"
DEPTH	64"
WIDTH	47"
HEIGHT	95.4"
WEIGHT	423 LB
NUMBERED HOLES	OPTIONAL
MATERIAL	11 GAUGE STEEL



SINGLE RACK

TUBING	3" x 3"
DEPTH	52.5"
WIDTH	47"
HEIGHT	95.4"
WEIGHT	317 LB
NUMBERED HOLES	OPTIONAL
MATERIAL	11 GAUGE STEEL



POWER RACK

TUBING	3" x 3"
DEPTH	76.5"
WIDTH	47"
HEIGHT	95.4"
WEIGHT	561 LB
NUMBERED HOLES	OPTIONAL
MATERIAL	11 GAUGE STEEL



DOUBLE HALF RACK

TUBING	3" x 3"
DEPTH	56.5"
WIDTH	47"
HEIGHT	95.4"
WEIGHT	657.0 LB
NUMBERED HOLES	OPTIONAL
MATERIAL	11 GAUGE STEEL



RACK AND A HALF

TUBING	3" x 3"
DEPTH	100.5"
WIDTH	47"
HEIGHT	95.4"
WEIGHT	782 LB
NUMBERED HOLES	OPTIONAL
MATERIAL	11 GAUGE STEEL



DOUBLE FULL RACK

TUBING	3" x 3"
DEPTH	144.5"
WIDTH	47"
HEIGHT	95.4"
WEIGHT	926 LB
NUMBERED HOLES	OPTIONAL
MATERIAL	11 GAUGE STEEL

UBER PACKAGE UPGRADE INCLUDES:



LANDMINE



HALF SAFETY BARS



CUSTOM LOGO ARCH



UTILITY SEAT



FULL SAFETY BARS



TWO BAR / UTILITY SEAT STORAGE



CUSTOMIZABLE STORAGE



SANDWICH STYLE J-HOOK



ROLLER PADS

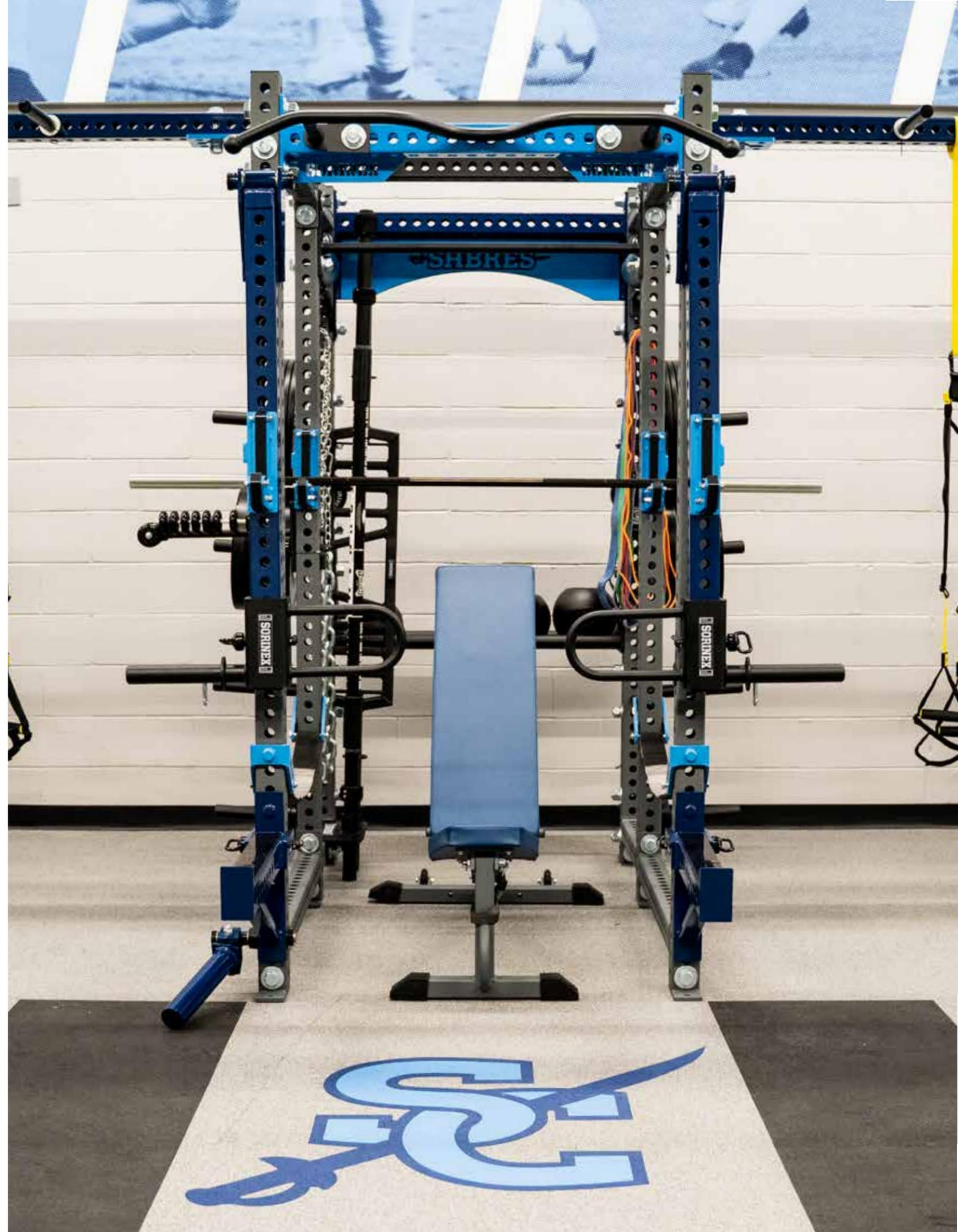



THE APEX™ RACK

MOST TRAINING OPTIONS PER SQUARE FOOT

At only 18 sq/ft, The Apex™ rack offers more training options per square foot than any other system on the market. The low profile rack design with functional cable columns, lat pull-low rows, and integrated storage solutions gives you options in a compact space. This is not your simple rack. This is everything the modern training space needs with 25% less square footage than a normal power rack. Training requirements have changed. Strength and conditioning facility needs are greater than ever. Home gyms have evolved past a barbell and pull-up bar. This is an all-inclusive training system that can be customized to fit any room or application. The Sorinex Apex rack has changed the game. Bring the versatility of Sorinex training systems to your compact commercial space, large facility accessory stations or garage gym.



TWO CABLE COLUMNS

TUBING	3" x 3"
DEPTH	28"
WIDTH	104.5"
HEIGHT	95.6"
MATERIAL	11 GAUGE STEEL



ONE CABLE COLUMN ONE LAT-PULL

TUBING	3" x 3"
DEPTH	28"
WIDTH	121.5"
HEIGHT	101"
MATERIAL	11 GAUGE STEEL

THE DARK HORSE™ RACK

THE ECONOMICAL OPTION

The Sorinex Dark Horse rack is our most economical rack offering. Intentionally made to fit your budget while still offering the innovation, quality, and attachment options our Sorinex racks are known for. Appropriately named, the Dark Horse rack boasts a compact design with extreme versatility. Add plate storage, custom arch logos or our industry leading rack attachments to make this rack your own. Built for high schools, private training facilities or garage gym owners. Welded rack sides and a partial 4-way hole design will stand the test of time. This rack offers a durable, affordable and safe Sorinex training system.



STANDARD

TUBING	3" x 3"
DEPTH	41.5"
WIDTH	47"
HEIGHT	89.6"
MATERIAL	11 GAUGE STEEL

WITH PLATE STORAGE

TUBING	3" x 3"
DEPTH	63.88"
WIDTH	47"
HEIGHT	89.6"
MATERIAL	11 GAUGE STEEL

*Safety Systems Upgrade Available



THE OFF GRID™ RACK

Created as a wartime solution for the COVID-19 pandemic, the OFF GRID™ rack is a minimalistic and cost effective solution to keep everyone training during a time of need. All profits on sales from the first two weeks were donated to fight COVID-19.



\$98,013.16 DONATED

Thanks to you, we were able to donate \$98,013.16 to fight Covid-19 through the Center for Disease Philanthropy on behalf of the Coaches vs. Covid-19 Fund.

HEIGHT	89"
DEPTH	13.5"
WIDTH	5"
THICKNESS	3/8"
COMPATABILITY	STANDARD OLYMPIC BARBELLS
MATERIAL	3/8" LASER CUT STEEL, OPTIONAL UMHW PLASTIC PROTECTION

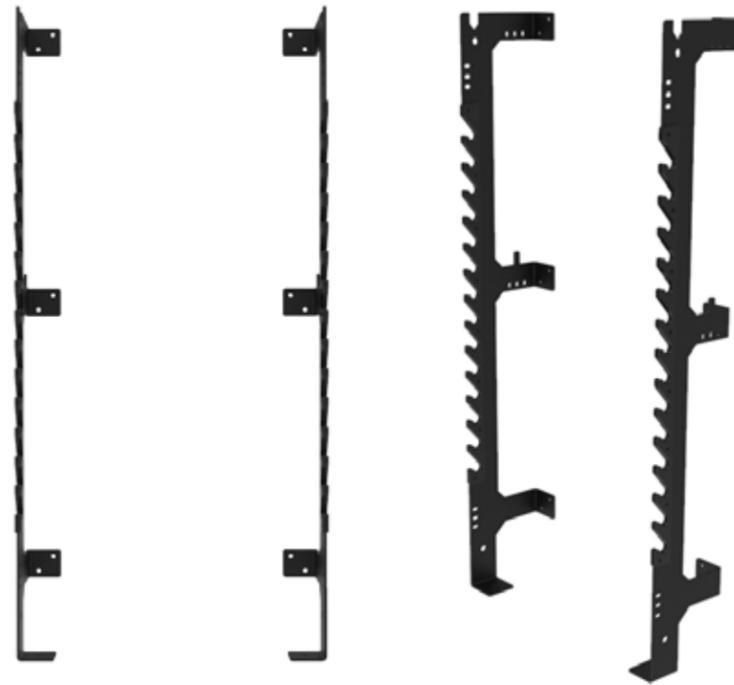

THE PEAK™ BAR STORAGE AND PULL UP SYSTEM



THE RIDGE™ WITH 14 BARBELL POSITIONS



24 CARABINER CLIP POINTS

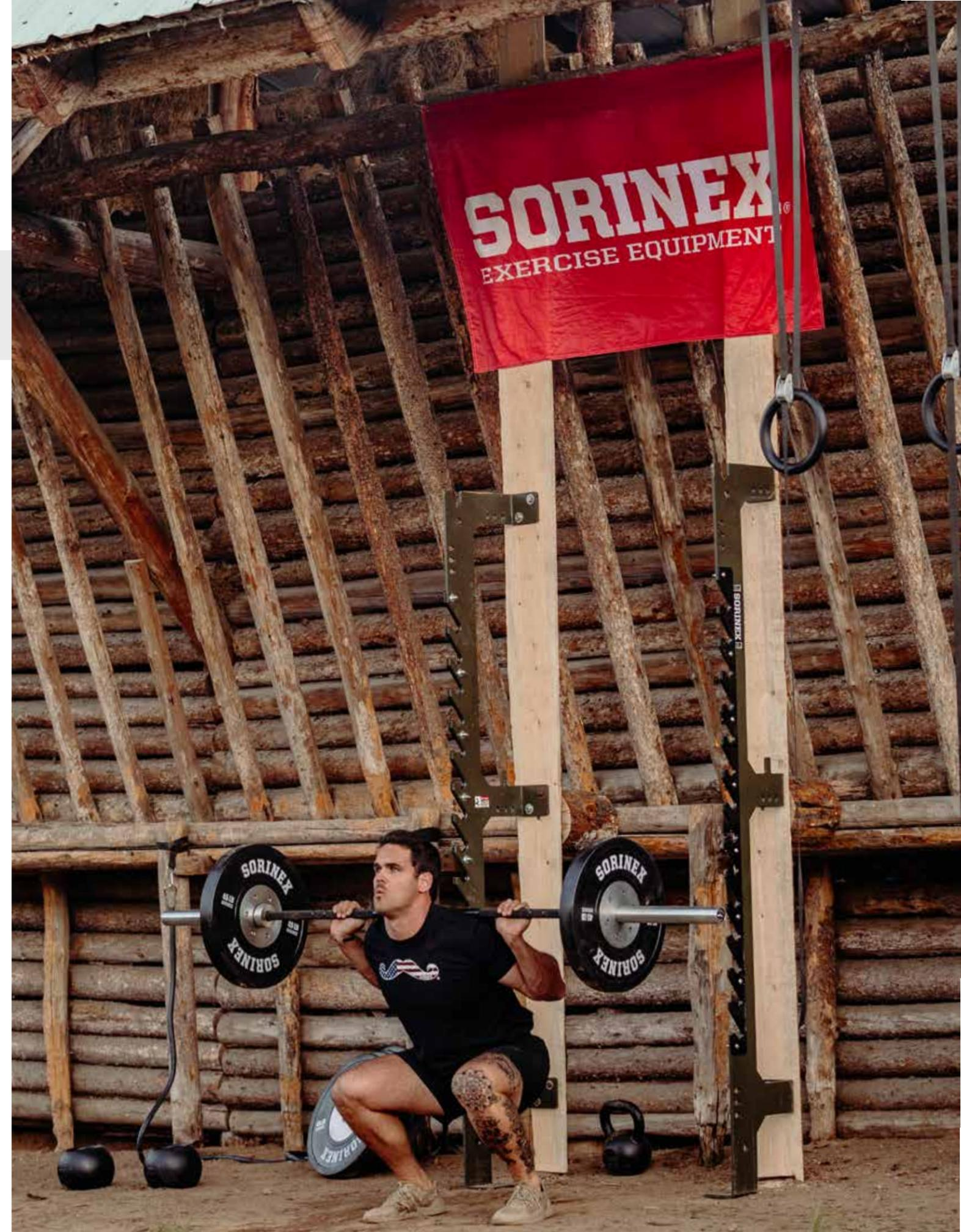

SQUAT STANDS



SHORT

TUBING	3" x 3"
DEPTH	53"
WIDTH	48"
HEIGHT	74.5"
MATERIAL	11 GAUGE STEEL



TALL

TUBING	3" x 3"
DEPTH	53"
WIDTH	48"
HEIGHT	98.5"
MATERIAL	11 GAUGE STEEL



DEPTH	24"
WIDTH	24" or 36"
HEIGHT	24"

THE SINGLE LEG SQUAT STAND

The Sorinex Single Leg Squat Stand is the industry standard. The easily adjustable squat stand comes with 9 different height options. Give your athletes the ability to move efficiently and develop unilateral leg strength & support with a lower risk. Load your movement with dumbbells, kettlebells, Center Mass Bells®, or barbells. Maximize your versatility with the 36" model by executing non-traditional movements like hip thrusts with your back on the rolling pad.





CUSTOM RIGS

Work with our Sorinex Solutions Specialists to custom configure your rig to maximize the versatility of your room with training options specific to your needs. Our custom rigs give you the most training options per square foot, and more athletes in your line of sight.

C U S T O M R I G S



We look at the specific needs of our clients and their athletes to come up with innovative training solutions for their facility. To meet the needs of a UFC fighter, we combined form, function, and art to create the Heavy Bag Cloud™. The prime objective was to have heavy bags accessible when needed, unrestricted by any upright, and provide a free open area to train; the solution, remove the uprights entirely. Sorinex took on the challenge of carefully engineering a structure which could withstand the beating it would take by a UFC fighter. Additionally, there was a need to adjust different bags in place to allow for a variety of training all in the same area. The bags were mounted to adjustable and lockable fixtures that could be easily moved and provide versatility for the athlete.

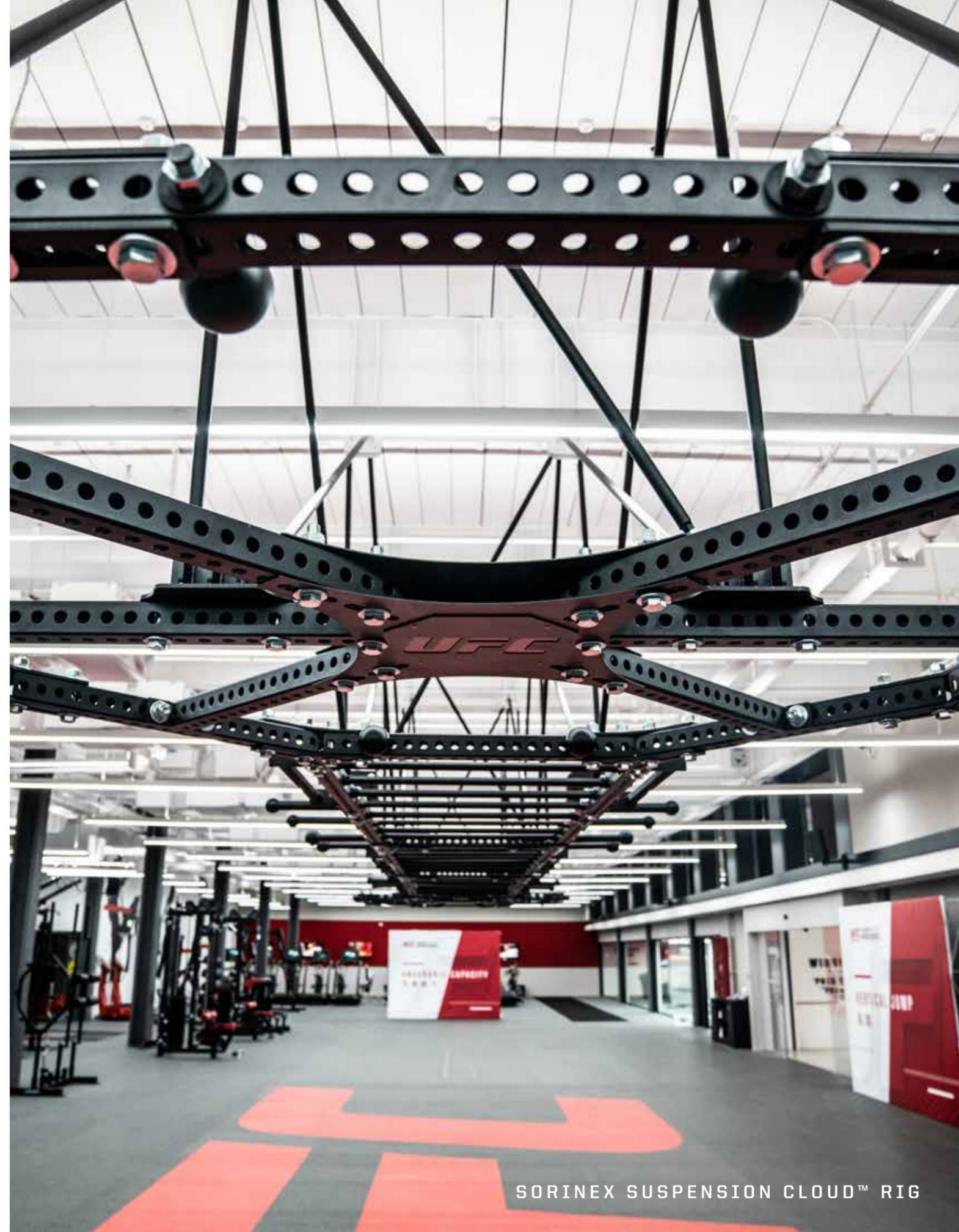



SORINEX

SORINEX

SORINEX

SORINEX

SORINEX

SORINEX

SORINEX

SORINEX

SORINEX

SORINEX

SORINEX





RACK ATTACHMENTS



JAMMER ARMS™

An industry first, the Sorinex Jammer Arms were designed with future innovation in mind. In the late 2000's, Sorinex introduced the first ever rack attached Jammer Arms. Many coaches wanted to utilize traditional jammer press movements but did not want to sacrifice floor space in their weight rooms. Sorinex created an innovative training solution that has now evolved in to the Adjustable Jammer Arms. As coaching philosophies changed and new training environments evolved, the Jammer Arms found their home. Fast forward to 2020 and the Jammer Arms are replacing big clunky leverage pieces with modularity and functional safety. Your training options are limitless with standing or seated bilateral and unilateral movements, dynamic, variable, or isometric options, and the ability to press, row, squat, or pull.

FIXED OR ADJUSTABLE

LENGTH	50"
WIDTH	3"
HEIGHT	3"



FIXED



ADJUSTABLE

HANDLES



STANDARD HANDLES



KNURLED HANDLES



SHOT HANDLES



The Safety Straps are another Sorinex Original and industry first. A deep understanding of load angles and force variation sparked this specific creation. The length of the straps creates slack at a very specific angle to absorb maximal load and force. Safer bench, squat, pulls and presses are must-have for the modern day training environment. Micro adjustments via 1" holes allow angled strap positioning to protect your neck while benching. Macro adjustments allow for all pulling and pressing to be performed inside the rack. Increase the longevity of your bars, minimize wear on the knurling and lower the risk in your training environment with our Safety Straps.

SAFETY STRAPS

LENGTH	DH: 32"
	XL: 42"
	BC: 43"
WIDTH	3"



HALF SAFETY BARS

LENGTH	24" or 30"
WIDTH	3"
HEIGHT	12"



FULL SAFETY BARS

LENGTH	XL: 41"
	BC: 42"
WIDTH	3"
HEIGHT	8"



PIPE STYLE SPOTTER BARS

LENGTH	32"
FITS	Dark Horse™ Racks Only

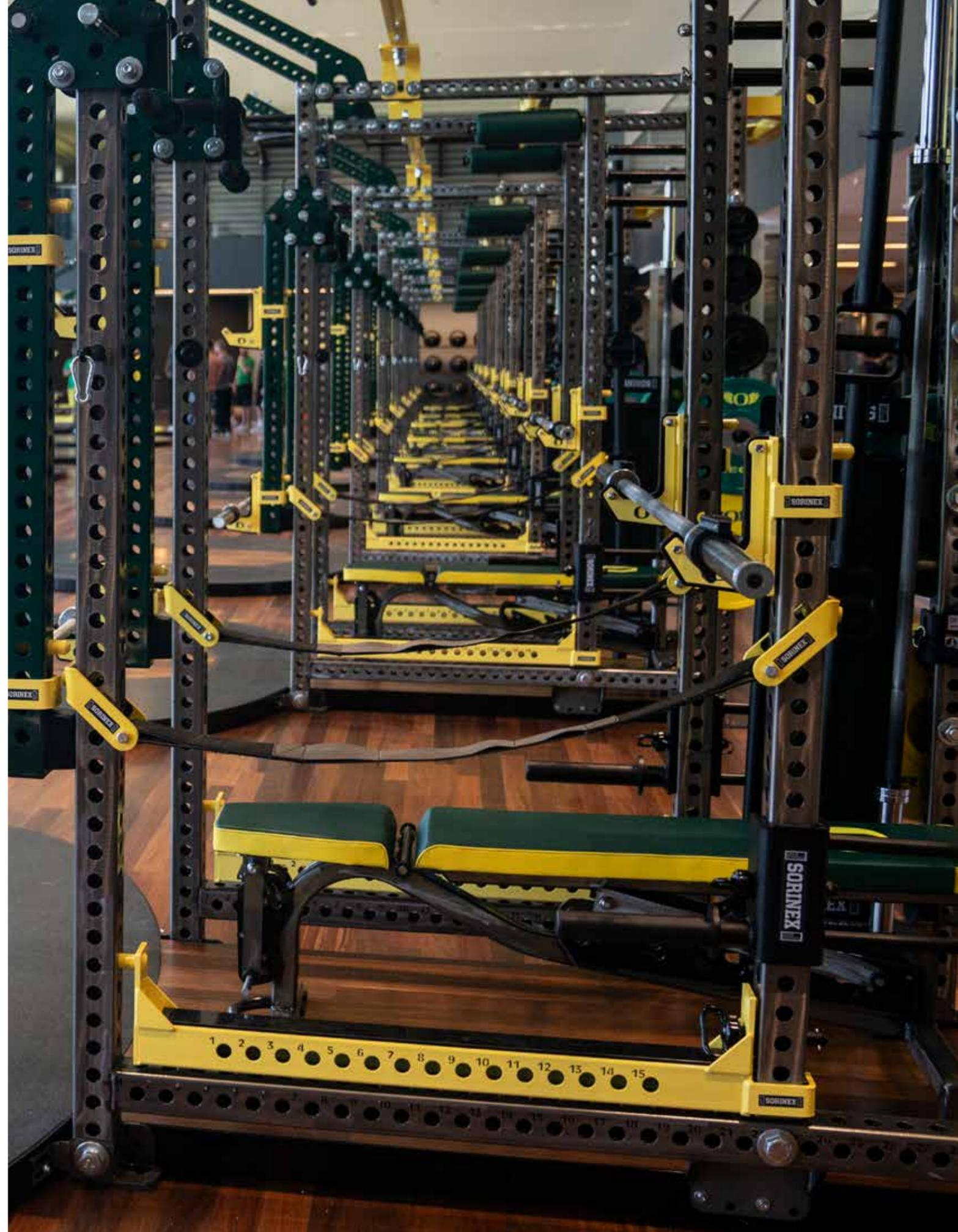

MEGABRIDGE™

Connect your racks with a custom Megabridge to create a unique functional and unique branding element in your facility. Go vertical and add versatility to your floor space by adding monkey bars, gymnastic rings, dip /chin ballpins, knurled chin bars, rock climbing boards, or other Sorinex attachments. The Megabridge is a one-of-a-kind solution that will function exactly how you need it. The University of Tennessee Jumbotron Megabridge (right) was made to dual function as an educational area for presentations, seminars, videos, product demonstrations, and team education, as well as a training space.



4-WAY HOLE DESIGN

UNLIMITED BOLT DESIGN

3" X 3" TUBING

11 GAUGE STEEL

CUSTOM LOGO OPTIONS

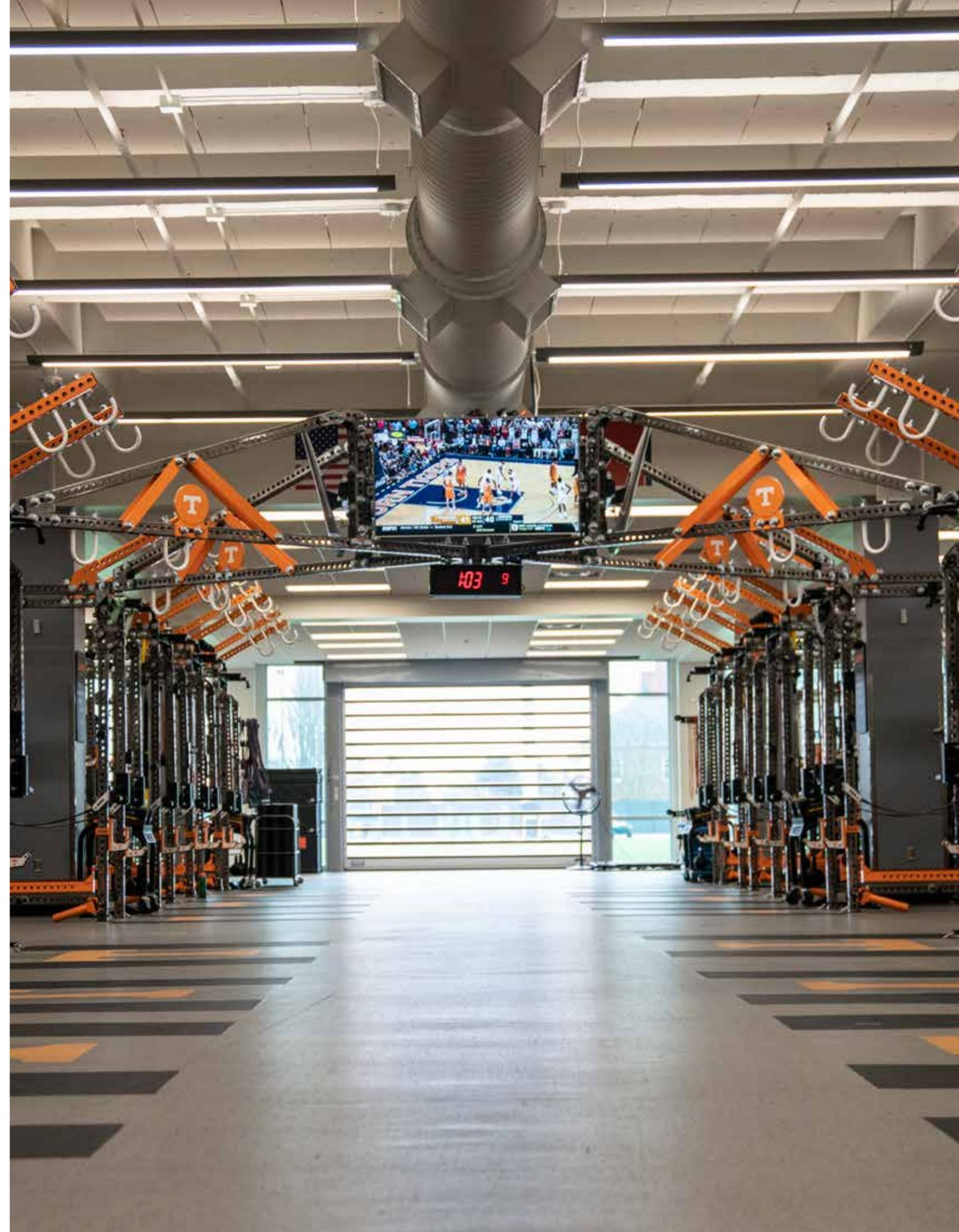

LANDMINE™ RACK ATTACHMENT

The Landmine™ is a Sorinex Original design, developed in 1999 to help co-owner, Bert Sorin, train for Hammer throwing in preparation for the 2000 Olympic Trials. The Sorinex Landmine created an integrated system for safer and more efficient barbell movement. Presses, rows, rotational movements and more. It was the first product to allow angular barbell movements. Attach the Landmine directly to the side of your rack, Iron Bear™ Storage unit, or Low Bridge™. It brings the barbell inside a fixed yet adjustable position allowing the athlete to perform sport specific movements.

LENGTH	16.5"
WIDTH	2.5"
WEIGHT	10 LBS
FITS	OLYMPIC BARS



SORINEX ORIGINAL DESIGN



UNIVERSAL SWIVEL JOINT



BRONZE OIL LITE BUSHINGS



LANDMINE™ DROP IN

LENGTH	17.125"
DIAMETER	2.5"
WEIGHT	17 LBS
FITS	OLYMPIC BARS



LANDMINE™ HOME BASE

LENGTH	18"
DIAMETER	2.5"
WIDTH	16"
WEIGHT	40 LBS
FITS	OLYMPIC BARS



LANDMINE™ SINGLE HANDLE

LENGTH	6.25"
WEIGHT	4 LBS
FITS	OLYMPIC BARS



LANDMINE™ COMBAT HANDLE

LENGTH	20.5"
WIDTH	15"
WEIGHT	11 LBS
FITS	OLYMPIC BARS



LANDMINE™ T-HANDLE

LENGTH	34.4"
WIDTH	10"
WEIGHT	11 LBS
FITS	OLYMPIC BARS



LANDMINE™ GRIFF HANDLE

LENGTH	10"
WIDTH	9.8
WEIGHT	7 LBS
FITS	OLYMPIC BARS



BATWING BAR

The Sorinex Batwing Chin Bar is designed to bolt-on to any side of your rack, rig, or bridge. Wide and narrow grip pull-ups, chin-ups, and variable grip positions are integrated into an ergonomic system for safer and more efficient movement.



LENGTH	60"
WIDTH	8"
HEIGHT	4"



STALL BAR

LENGTH	41"
GRIP DIAMETER	1-5/16"



KNURLED CHIN BAR

LENGTH	55"
HEIGHT	3"
GRIP DIAMETER	1-3/8"



FAT KNURLED CHIN BAR

LENGTH	41"
HEIGHT	3"
GRIP DIAMETER	2"



FATWING BAR

LENGTH	26.5"
WIDTH	14.6"
GRIP DIAMETER	2"



INDEXING CHIN BAR

LENGTH	41"
WIDTH	10"
GRIP DIAMETER	1.25"



CLIFF HANGERS

LENGTH	9"
WIDTH	3"
GRIP DIAMETER	1"



MONKEY CHIN BAR

LENGTH	41"
WIDTH	19"
HEIGHT	6.2"



DIP / CHIN BALLPIN

LENGTH	12" + ball size
BALL DIAMETER	3" or 4"



EL DIABLO DIP BAR

LENGTH	30"
WIDTH	27"
GRIP DIAMETER	2"

J^xSQUAT[®]

Introducing the Sorinex J^xSquat[®] attachment. The first rack attached Jammer Arm belt squat. In 2012, Sorinex introduced the first ever rack attached Jammer Arms that then evolved into the Adjustable Jammer Arms. Attach your J^xSquat[®] attachment to fixed or Adjustable Jammer Arms and replace your big clunky belt squat machines with a modular, functional, and safe design. The J^xSquat is the most versatile belt squat on the market, with no platform required.

LENGTH	50"
WIDTH	3"
HEIGHT	27"
SLEEVE LENGTH	16"
BELT	INCLUDED

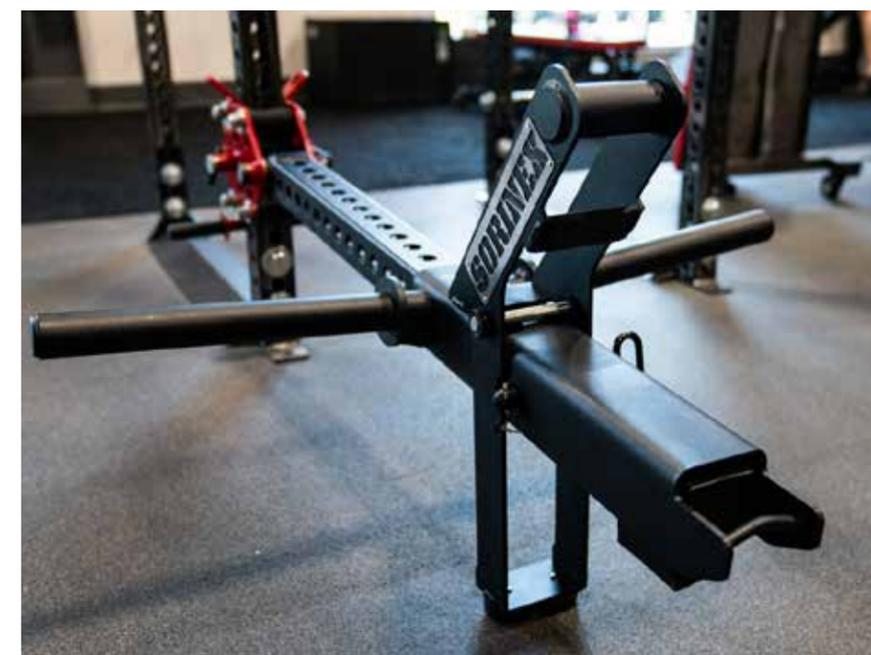

FREESTANDING J^xSQUAT

SINGLE LENGTH	68"
DOUBLE LENGTH	106"
STORED HEIGHT	67"
SLEEVE LENGTH	16"
FULCRUM POINT	16" FROM GROUND





The Sorinex Utility Seat gives you options for multiple rack attached applications. Attach your Utility Seat to Full or Half Safety Bars for box squats or step ups. Attach to the front of your rack to create an integrated med ball wall. Attach to your Jammer Arms for seated leg presses or dynamic upper body presses. Securely store your Utility Seat vertically within your rack system when not in use via the 2-Bar Storage unit. Control the risk in your training environment and allow more athletes than ever to train at one station to increase the carrying capacity of your facility.

UTILITY SEAT

LENGTH	45.5"
WIDTH	13.5"
HEIGHT	3"



RACK ATTACHED KPULLEY™

WIDTH	14.4"
DEPTH	13.4"
WEIGHT	22"
WHEEL	SMALL: 0.010 KGM ² LARGE: 0.050 KGM ²



VERTIMAX RAPTOR™

WIDTH	40"
HEIGHT	7"
DEPTH	5.5"
CORD	3/8" (12-24 LBS EXPECTED LOAD)



ADJUSTABLE HEAVY BAG HANGER

LENGTH	22"
WIDTH	8"
HEIGHT	7"
ADJUSTMENT POINTS	3



MONOLIFT

LENGTH	22"
WIDTH	3.5"
HEIGHT	19"
J-HOOK DEPTH	2"



STRETCH LOOP

LENGTH	14"
WIDTH	8"
HEIGHT	2.5"
PIPE DIAMETER	1"



4-WAY NECK MACHINE

LENGTH	36"
WIDTH	3"
HEIGHT	24"

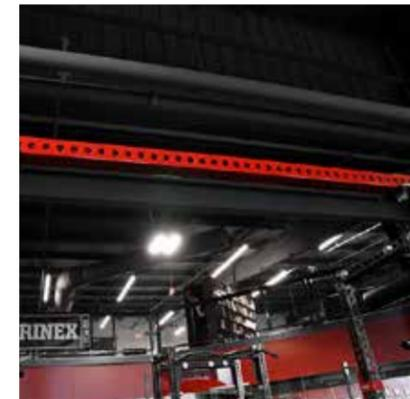

HIGH BRIDGE

LENGTH	6'-10'
WIDTH	3"
HEIGHT	3"
MATERIAL	11 GAUGE STEEL

The Sorinex High Bridge is a variable length rack connector that can be used in conjunction with a multitude of implements. An industry first, providing an integrated system for space saving efficiency between racks, rigs, or station-to-station. The Sorinex High Bridge brings the athlete outside the rack allowing them to perform specific movements utilizing various attachments, attachment points, and suspension tools between your Base Camp, XL Series, and Dark Horse Racks. Attach a TRX strap, another batwing bar, cable machines or storage solutions to utilize all of the space in your facility. Keep your athletes in a centralized location and control the risk in your training environment.



CUSTOM LOGO ARCH

Our custom branded solutions for logo arches makes your rack a one-of-a-kind. It will catch the eye of anyone who walks into your facility. Our team of designers and craftsmen expertly combine multiple layers of laser cut American steel to bring the detail of your brand to life.

WIDTH	41"
DEPTH	3"
HEIGHT	21"



TRIPHASIC BARS™

Inspired by the innovative training book, *Triphasic Training* by Cal Dietz and Ben Peterson, the Sorinex Triphasic Bars are another Sorinex Original and industry first. There are three phases to Triphasic Training: Eccentric, Isometric, and Concentric. It is widely considered one of the most scientifically advanced methods used for explosive power and strength development. The Triphasic Bars are used in the third, Concentric, phase of training.

Primarily used for over speed banded plyometric jumps, the bars can also be banded to Jammer Arms for dynamic push/pull movements. Utilize them as high attachment points for TRX straps, rings, heavy bags, and more.



LENGTH	46"
WIDTH	3"
HEIGHT	26.75"
WEIGHT	32 LBS
TUBE SIZE	3" x 3"
MATERIAL	11 GAUGE STEEL



SECURED WITH 1" COLD ROLLED STEEL BOLTS



COMPATIBLE WITH MOST SORINEX RACKS



UPPER AND LOWER BODY MOVEMENT CAPABILITIES

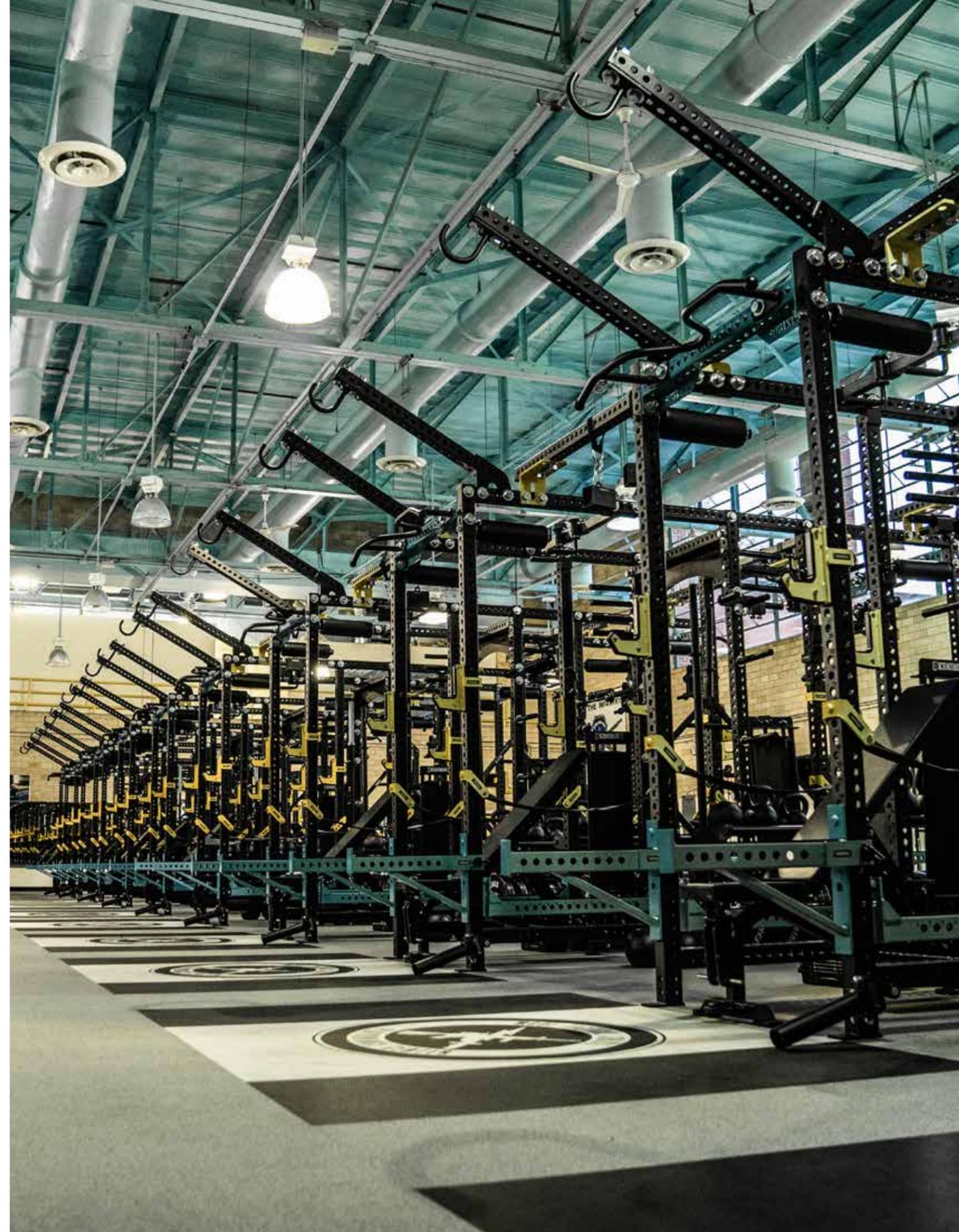

SANDWICH STYLE J-HOOK

The Sorinex Sandwich Style J-Hook is the industry standard for safety and versatility. It features replaceable HDPE plastic inserts and a curved design to increase safety and minimize the risk of the bar getting "caught" under a j-hook while benching and squatting. The Sorinex Sandwich Style J-Hooks utilize our 4-way hole design, and can be secured in any direction front to back or side to side. Custom color and logo options are available. The Sandwich Style J-Hook comes standard on all Base Camp™ Series racks.

DEPTH	10.5"
WIDTH	3"
HEIGHT	10"

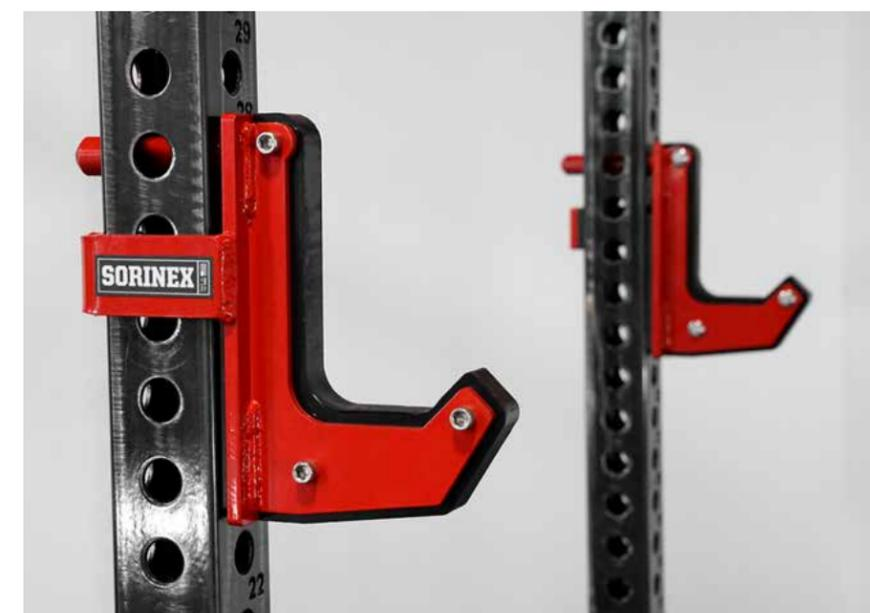

CUSTOM COLOR AND LOGO OPTIONS



HDPE PLASTIC INSERTS (REPLACEABLE)



LASER CUT AND FORMED AMERICAN STEEL



**THE MULE™
RACK ATTACHED
LEG CURL**

HEIGHT	24"
WIDTH	33.5"
ROLLER PAD LENGTH	16"
FLAT TOP PAD LENGTH	18.5"



**REMOVABLE
THIGH PAD
ATTACHMENT**

PAD WIDTH	16"
DEPTH	17"
WIDTH	28"
HEIGHT	9"



ROLLER PAD

PAD LENGTH	16"
FULL LENGTH	22"
WIDTH	6"
WEIGHT	8 LBS



**LONG SLIDING
BAND PEGS**

LENGTH	24"
WEIGHT	4 LBS

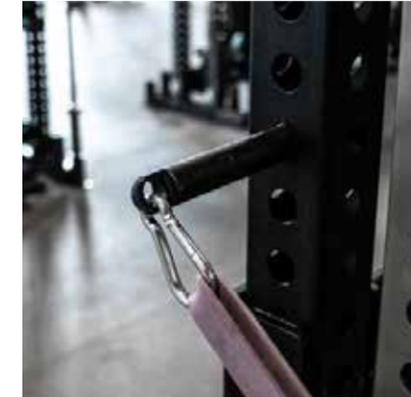

**JAMMER ARM
BAND PEGS**

LENGTH	9"
WEIGHT	2 LBS



**RACK ATTACHED
CHALK BOWL**

LENGTH	13.5"
WIDTH	12"
HEIGHT	11"



**XL SERIES™
J-CUPS**

LENGTH	9.5"
WIDTH	3.375"
HEIGHT	10"



SHORT BAND PEGS

LENGTH	5.6"
WEIGHT	2 LBS



HITCH PIN

LENGTH	7.8"
WIDTH	3.5"
WEIGHT	2 LBS
PIN DIAMETER	1"



TRIGGER ROLLER

LENGTH	11.5"
WIDTH	3.25"
WHEELS	URETHANE



TRIGGER BAR

LENGTH	24.125"
WIDTH	4.75"
WHEELS	URETHANE



**SLIDING FOOT
BLOCKS**

LENGTH	11.625"
WIDTH	6"
STEEL RODS	16"

THE BULLDOG™ PAD

This patent pending rack attached chest supported row can be utilized for rows or flys using a barbell, dumbbells, Center Mass Bells®, kettlebells, sandbag, or cable machine. This unit has four adjustment angles and can support arms, legs, head, or back for added stability during a multitude of pressing and pulling movements. Space saving design compared to stand alone chest supported row machine. The Bulldog Pad comes standard with black/black naugahyde upholstery. Custom colors available.

DEPTH	10.5"
WIDTH	3"
HEIGHT	10"

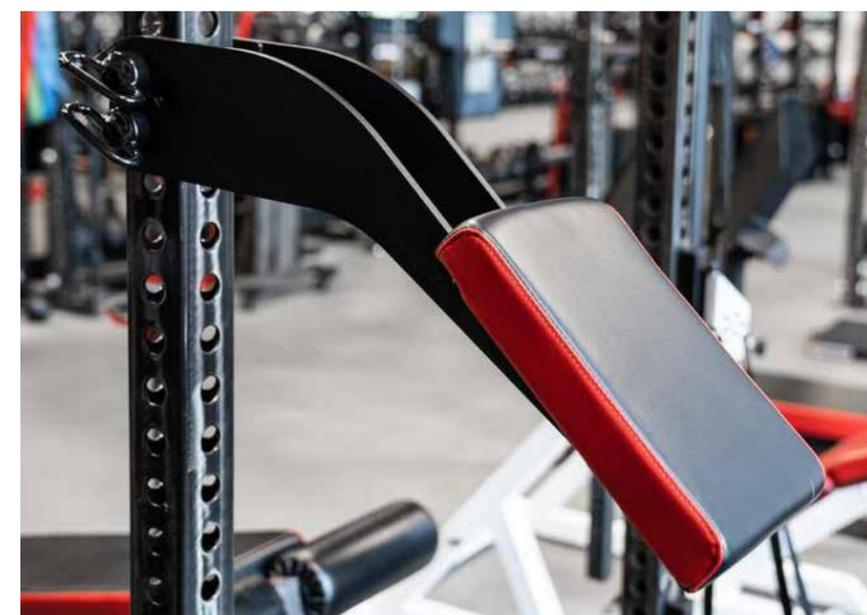

FOUR ADJUSTABLE ANGLES

DOUBLE STITCHED PREMIUM
NAUGAHYDE LEATHER

FOLDING DESIGN FOR EASY STORAGE





MACHINES

LAT PULL - LOW ROW

A super duty, oversized, seated lat pull-low row apparatus with an unbreakable 300 LB or 400 LB selectorized weight stack to accommodate athletes up to 7' tall. Adjustable band attachment points add an additional resistance option to the weight stack. Attach the lat pulldown to your Base Camp rack, XL Series rack/rig, Iron Bear™ storage unit, or high bridge using our 4-way hole design. Unlike other lat machines that use a one cable system that increases the load ratio to make the weight feel lighter, our lat pull-low row features a dual connection point cable system to maintain a 1:1 load ratio. Premium upholstery and logo options make this machine the most versatile unit on the market.

DEPTH	51"
WIDTH	30"
HEIGHT	101.125"
WEIGHT STACK	300 LB OR 400 LB
RATIO	1:1

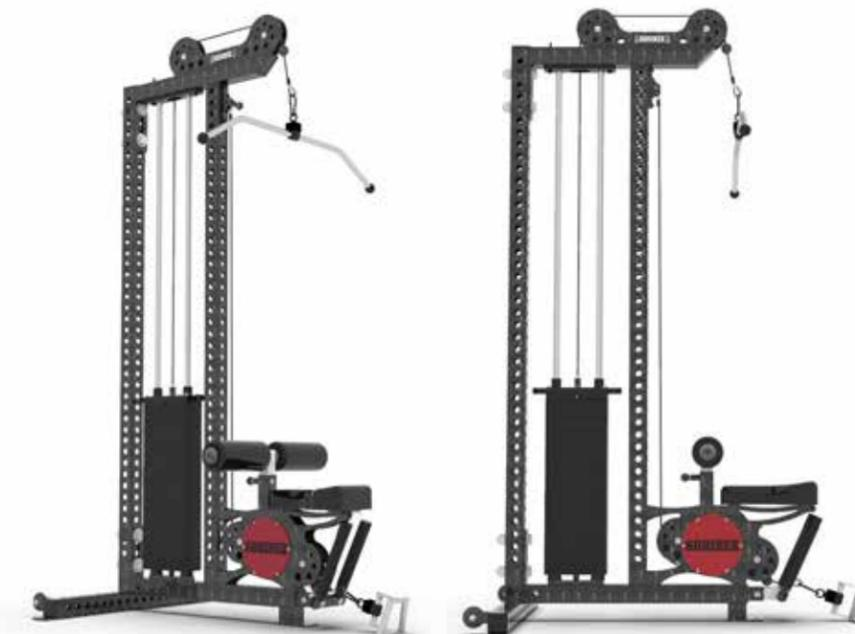

300 LB OR 400 LB WEIGHT STACK W/
ADJUSTABLE BAND ATTACHMENT POINTS



3/16" NYLON COATED AIRCRAFT CABLE



MODULAR KNURLED FOOT PEGS

FUNCTIONAL CABLE COLUMN

A heavy duty functional cable column with an unbreakable 250 LB or 300 LB selectorized weight stack. Adjustable band attachment points add an additional resistance option to the weight stack. Attach the Sorinex Functional Cable Column to your Base Camp rack, XL Series rack/rig, Iron Bear™ storage unit, or high bridge using our 4-way hole design. This machine is the most versatile cable unit on the market.

DEPTH	33"
WIDTH	4"
HEIGHT	101.125"
WEIGHT STACK	250 LB OR 300 LB
RATIO	2:1

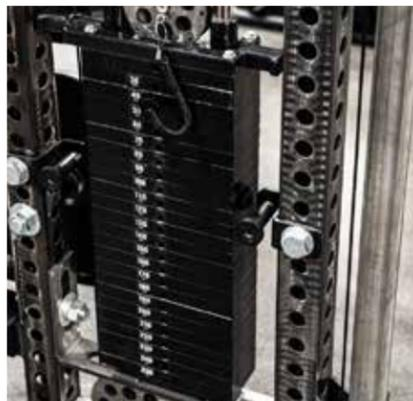
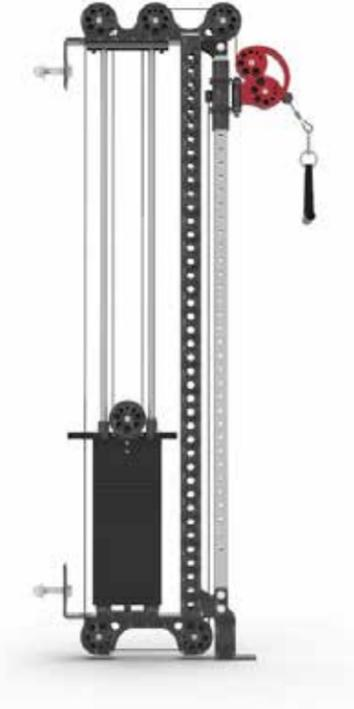

250 LB OR 300 LB WEIGHT STACK W/
ADJUSTABLE BAND ATTACHMENT POINTS



3/16" NYLON COATED AIRCRAFT CABLE



ADJUSTABLE ATTACHMENT POINT



LEG PRESS

The Sorinex Leg Press features a diamond plate foot platform, adjustable double-stitched premium naugahyde back pad, six 14" modular urethane utility storage pins, four 16" fixed pin sections for loading, and four band attachment points. Custom colors and branding options are available.



DEPTH	104"
WIDTH	48"
HEIGHT	60"
FELT WEIGHT	110 LBS



DIAMOND PLATE FOOT PLATFORM AND DOUBLE-STITCHED PREMIUM NAUGAHYDE

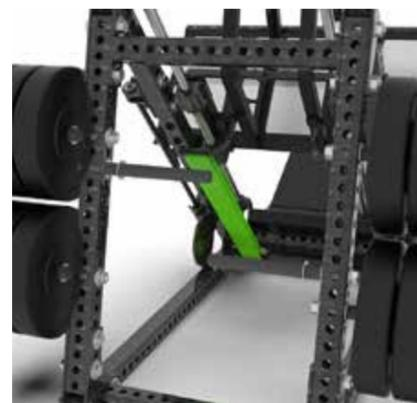

SIX 14" FIXED URETHANE UTILITY PINS FOR STORAGE AND BAND ATTACHMENT POINTS

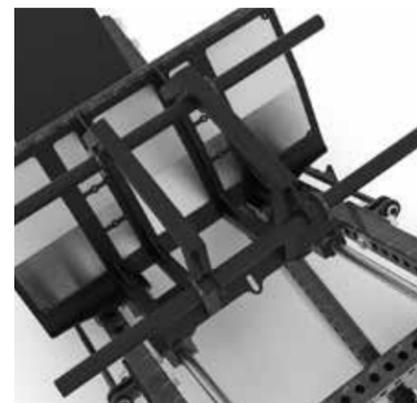

FOUR 16" SECTIONS FOR LOADING

BACK ATTACK™

This Sorinex original design was created over two decades ago. It is the secret training tool for some of the strongest gyms in the world. In 2000, Richard and Bert Sorin alongside Olympic Medalist Lance Deal, innovated a way to safely strengthen glutes and hamstrings without risk of injury to their arms and shoulders. Similar in movement pattern to a Good Morning, the Back Attack increasingly loads the posterior chain as the movement is performed. It is plate loaded with band attachment points for maximum versatility.



DEPTH	60"
WIDTH	80"
HEIGHT	66"
WEIGHT STACK	PLATE LOADED



ADJUSTABLE HEIGHT



BAND ATTACHMENT POINTS

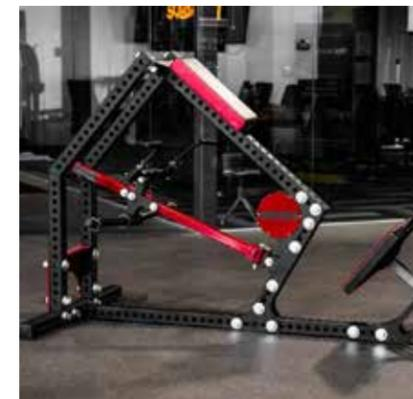

CHEST SUPPORTED ROW MACHINE

LENGTH	91.5"
WIDTH	47"
HEIGHT	60"
PAD WIDTH	10"
DIAMOND FOOT PLATE WIDTH	25"



LEG EXTENSION / CURL MACHINE

DEPTH	36"
WIDTH	36"
HEIGHT	82"
WEIGHT STACK	300 LBS



HURRICANE™

LENGTH	63"
WIDTH	47"
HEIGHT	55"
MAX LENGTH W/ ATTACHMENTS	74"
MAX HEIGHT W/ ATTACHMENTS	90"



GLUTE HAM DEVELOPMENT

FRANKENHYPER™

The Sorinex Original Frankenhyper was created in 2013. The “Franky” combines a glute ham developer with a pendulum hip extension to create a monster posterior chain training machine that only takes up a few square feet of space in your facility. The Frankenhyper allows for the entire rear of the body to be worked through contraction and decompression. The pendulum style weight arm is used for swinging hip extensions and can also be used for upper body movements like rows, face pulls, curls, pull thru’s, presses, TKE’s, and YTM’s. Incorporate loaded abdominal movements in the supine position with integrated med ball storage. Each Frankenhyper comes standard with bumper weight plate storage and band attachment points.

LENGTH	72"
WIDTH	36"
HEIGHT	59"
WEIGHT	400 LBS
PAD WIDTH	36"
PAD THICKNESS	3"
WHEELS	URETHANE



COMBINATION GHD AND
PENDULUM HIP EXTENSION

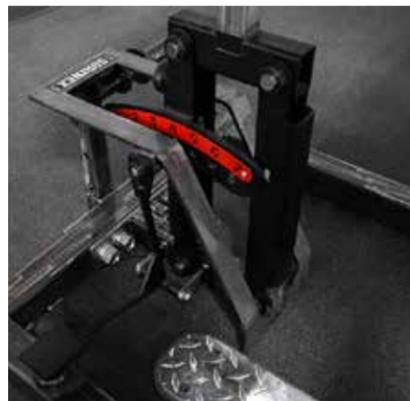

ADJUSTABLE PARALLEL FOOT LEVER

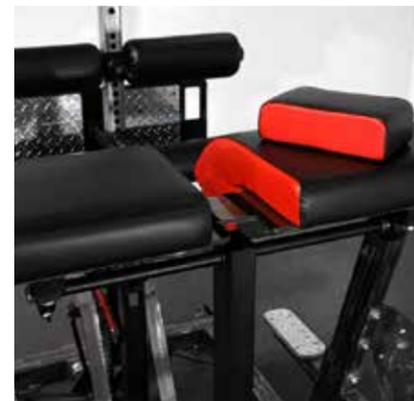

REMOVABLE "MAN CANYON" PAD



COLLEGIATE GHD

The Sorinex Glute Ham Developer (GHD) has been completely redesigned for 2020. Utilizing our 4-way hole technology, the new GHD is multi-functional and accepts most Sorinex Rack Attachments. This is the most versatile GHD on the market. Like most Sorinex machines, the GHD will save you space and increase the adaptability of your weight room. The 3-Way Adjustable Foot Plate allows every size of athlete to move comfortably and securely. Utilize for glute ham raises, back extensions, abdominal work, and more.

DEPTH	69"
WIDTH	36.5"
HEIGHT	55.25"
PAD WIDTH	11" EA. (2 PADS)
PAD HEIGHT	10"
WHEELS	URETHANE



DIAMOND PLATE UTILITY STEP
AND FOOT PLATE



INTEGRATED PLATE STORAGE AND BAND
ATTACHMENT POINTS



3-WAY ADJUSTABLE FOOT PLATE WITH
PARALLEL FOOT LEVER

GLUTE HAM ROLLER

Sometimes the simplest solutions are the best. The Sorinex Original Glute Ham Roller is the definition of a simply designed, innovative training solution. Designed specifically to be the best hamstring curl unit possible, we quickly found that it was great for a variety of ab, shoulder, leg and chest exercises as well. The Glute Ham Roller allows you to add or subtract resistance easily and is perfect for large groups, tight budgets, or mobile training needs.



LENGTH	15.75"
WIDTH	25.25"
WEIGHT	20 LBS



V-SHAPE ANCHOR POINT FOR HEELS/TOES



BLACK URETHANE WHEELS WITH ABEC BEARINGS



10-PACK WITH ROLLING STORAGE AVAILABLE

GLUTE HAM DEVELOPMENT



HUNGARIAN CORE BLASTER

HEIGHT	18"
WEIGHT	11 LBS
GRIP DIAMETER	1"



HIP THRUSTER

LENGTH	56"
WIDTH	33.5"
HEIGHT	16"



MACH-II™ GHD

LENGTH	66"
WIDTH	34"
HEIGHT	50"
PAD SIZE	36" x 12"



P3 POOR MAN™ GHD

LENGTH	57.5"
WIDTH	22.25"
HEIGHT	19"

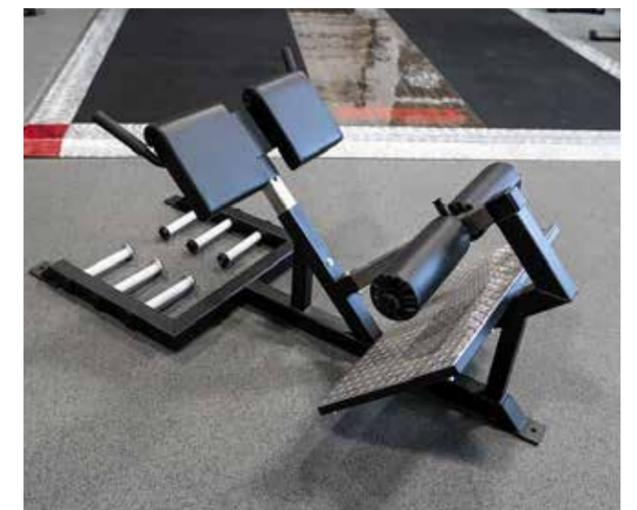

45 DEGREE HYPER

DEPTH	70"
WIDTH	29.50"
HEIGHT	30.5"



S T O R A G E

IRON BEAR™ MULTI STORAGE UNIT

The Sorinex Iron Bear™ is the ultimate storage unit. Configurations and options vary from simple dumbbell, kettlebell, and med ball storage to complex anchoring points and one-of-a-kind storage solutions. Heights vary from 4' to 8' depending on your configuration and can accept 3-6 levels of storage trays.

The Iron Bear is built with the same 3" x 3" materials as our Base Camp™ and XL Series™ racks. Attach a Jammer Arm™ for J*Squat™ Belt Squats, Cable Columns or Lat Pull/Low Rows, and unique branding solutions. The Iron Bear sides are built with 4 Vertical Bar Storages that can also be used for Landmine™ drop-ins. Attach Utility Pins for Bumper Plates, bands, or weight vest storage.

Connect your Iron Bear to your rack or rig with a High Bridge, Low Bridge, or Mega Bridge for increased support and versatility.



EXPANDABLE HEIGHT & CONFIGURATIONS



UNLIMITED ATTACHMENTS



OUTRIGGER TO RACKS

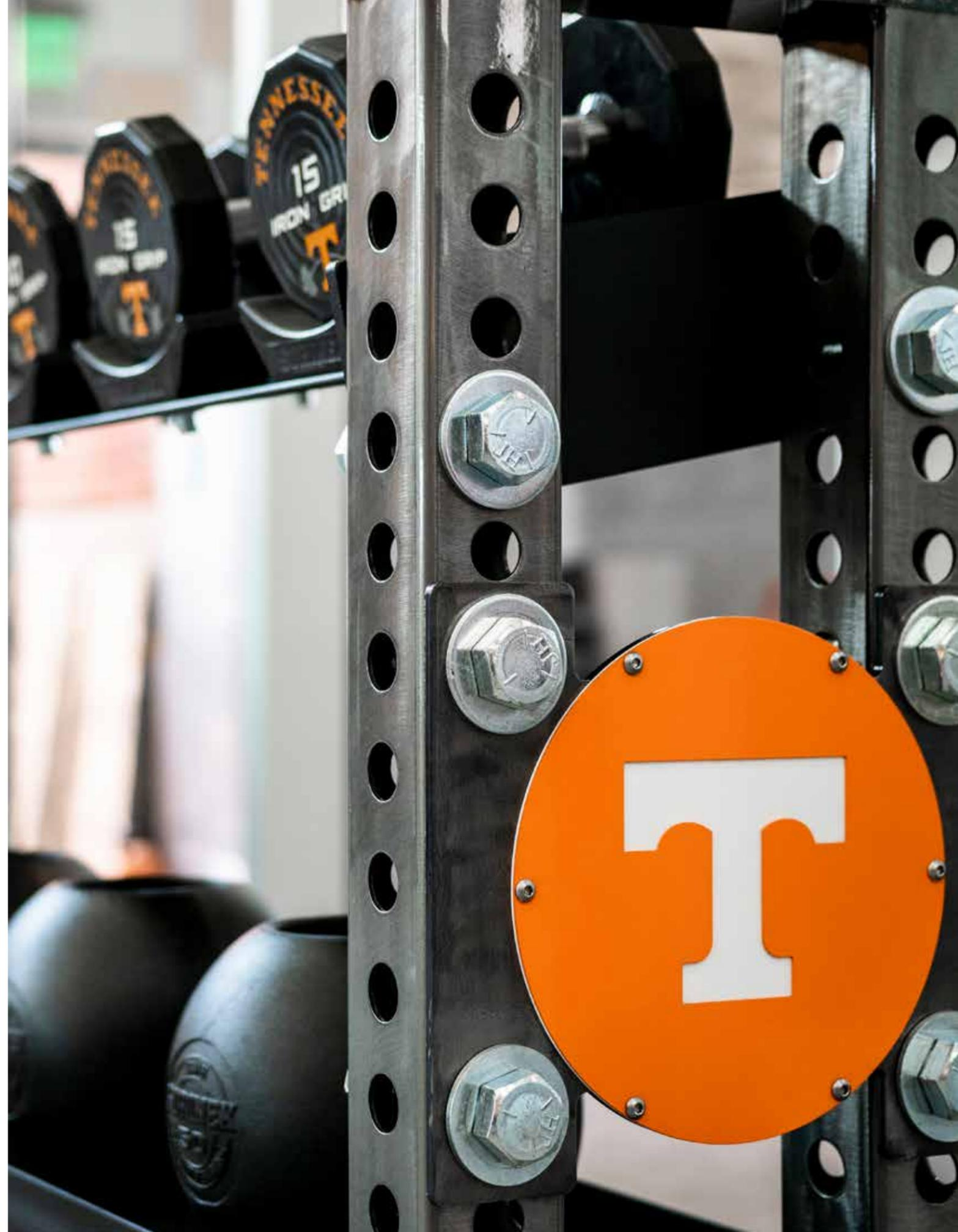

Multiple Iron Bear units can also be attached to each other by sharing sides to minimize cost, increase versatility, and maximize floor space. The versatility of this unit is unmatched and can be specifically customized to unique space requirements, branding, or other needs.

The custom made Iron Bear Pillar Wrap (right) is a perfect way to incorporate branding and storage in an otherwise unused space. Free up floor space to add more training stations, maximizing training options per square foot.

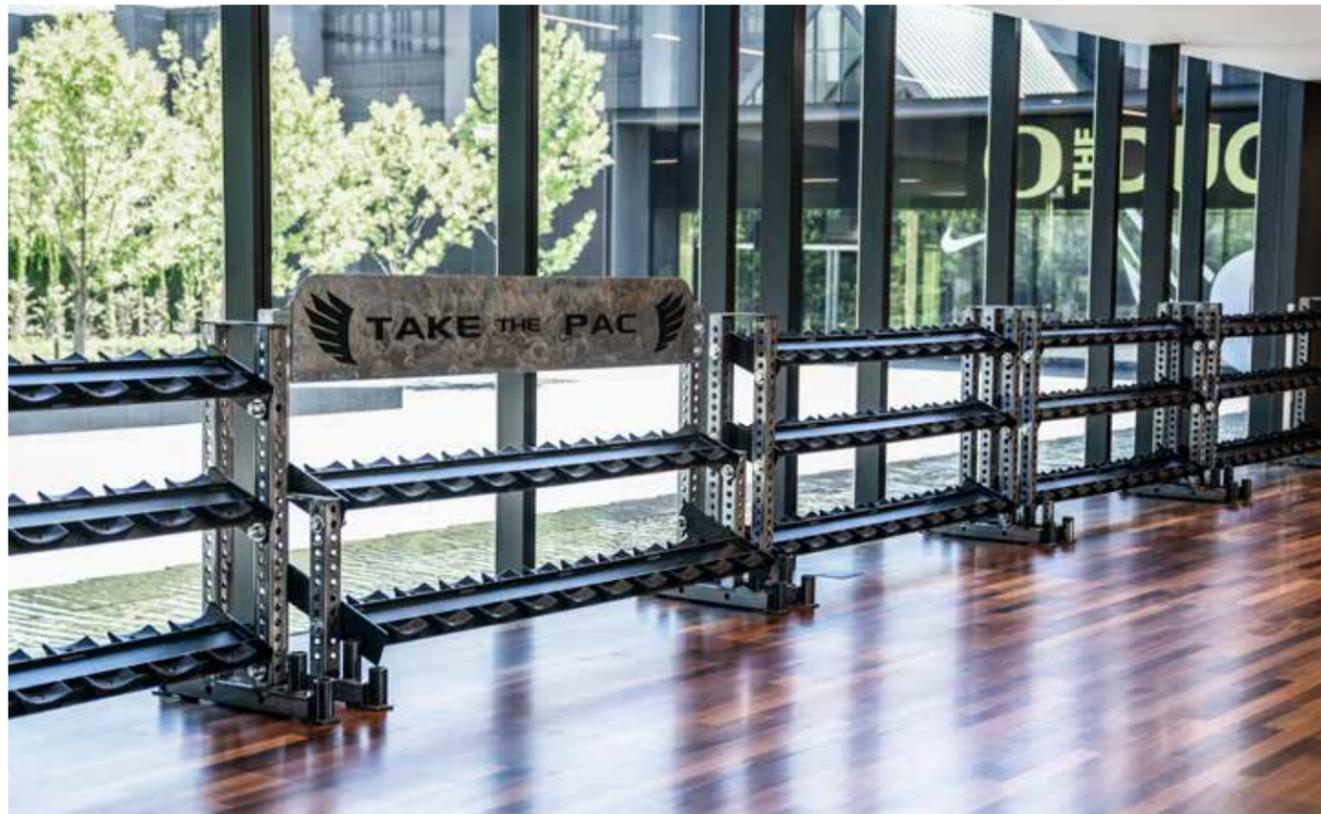

ROLLING POWER BLOCK CART

The Sorinex Rolling Power Block Cart is built with lockable, heavy-duty wheels, precision welded steel, and two levels of storage shelves to hold up to four Power Blocks. Easily customize your cart with specific storage solutions or branding unique to your school's colors and logos. The standard version covers Power Blocks up to PRO125 and is designed for the extra handles to be stored on the bottom. The wide version covers Power Blocks up to PRO175 and is designed for the extra handles to be stored on the top between the blocks with the bottom shelf open for more storage space.

LENGTH	23.5"
WIDTH (STANDARD)	21"
WIDTH (WIDE)	29"
HEIGHT	30"
WHEELS	HEAVY-DUTY LOCKABLE



LOCKABLE HEAVY-DUTY WHEELS

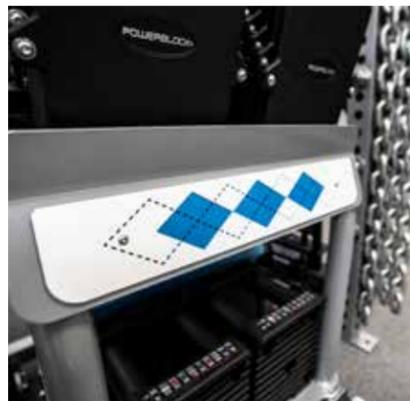

TWO LEVELS OF STORAGE SHELVES



WIDE OPTION AVAILABLE





ROLLING BUMPER CART

LENGTH	48"
WIDTH	81"
HEIGHT	76.25"
WHEELS	HEAVY-DUTY LOCKABLE



ROLLING DC BLOCK CART

DEPTH	32.06"
WIDTH	25.13"
HEIGHT	45.67"
WHEELS	HEAVY-DUTY LOCKABLE



STORAGE CART

LENGTH	47"
WIDTH	31"
HEIGHT	45"
WHEELS	HEAVY-DUTY LOCKABLE



4-BAR STORAGE

LENGTH	28"
WIDTH	16"
HEIGHT	8.375"

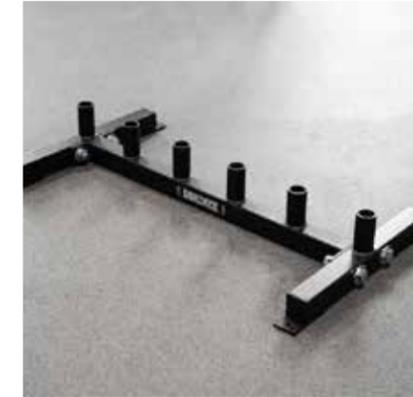

6-BAR STORAGE

LENGTH	53"
WIDTH	31"
HEIGHT	3.5"



9-BAR STORAGE

LENGTH	18"
WIDTH	22"
HEIGHT	6"



RAPTOR MOBILE TRAINING STORAGE

DEPTH	28"
WIDTH	54"
HEIGHT	69.50"
WHEELS	HEAVY-DUTY LOCKABLE



BUMPER BENCH

DEPTH	16"
WIDTH	48"
HEIGHT	22"
WHEELS	HEAVY-DUTY LOCKABLE



GYM RAT

LENGTH	39"
WIDTH	20"
HEIGHT	50"
WHEELS	HEAVY-DUTY LOCKABLE



10-BAR STORAGE

LENGTH	39"
WIDTH	29"
HEIGHT	10"



WALL MOUNTED GUN RACK 4-BAR STORAGE

LENGTH	5.2"
WIDTH	3.2"
HEIGHT	24"



FIXED BARBELL RACK

DEPTH	30"
WIDTH	57.6"
HEIGHT	57"

LOW BRIDGE

The Low bridge increases the versatility of your facility by using an open integrated system for space saving efficiency between open wall spaces, racks, rigs, or station-to-station. The Sorinex Low Bridge brings the athlete outside the rack allowing them to perform specific movements utilizing various attachments, attachment points, and storage between columns, racks or open wall space. Attach the J*Squat, Landmines, bands, mobility tools, trigger rollers, PVC pipes or storage solutions to utilize all of the space in your facility. Keep your athletes in a centralized location and control the risk in your training environment. Allow more athletes than ever to train by increasing the carrying capacity of your facility. The configurations and adjustments are endless. The Sorinex Low Bridge utilizes our 4-way hole design allowing all bars, brackets, and add-ons to be secured in any direction front to back or side to side. Secure to the floor, wall, or columns.

LENGTH	6' - 10" Sections
WEIGHT	36 LBS +
TUBE SIZE	3" x 3"
4-WAY HOLES	YES
MATERIAL	11 GAUGE STEEL

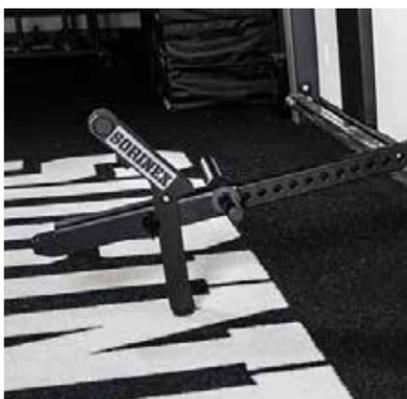
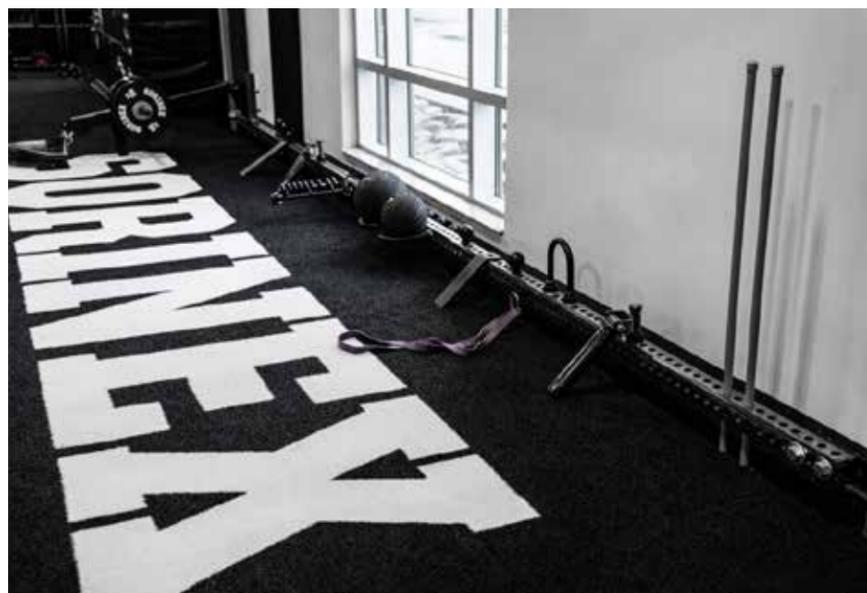

UPGRADE TO THE J*SQUAT PACKAGE



ENDLESS CONFIGURATIONS



BRIDGE SECTIONS TOGETHER TO MAXIMIZE UNUSED FLOOR SPACE

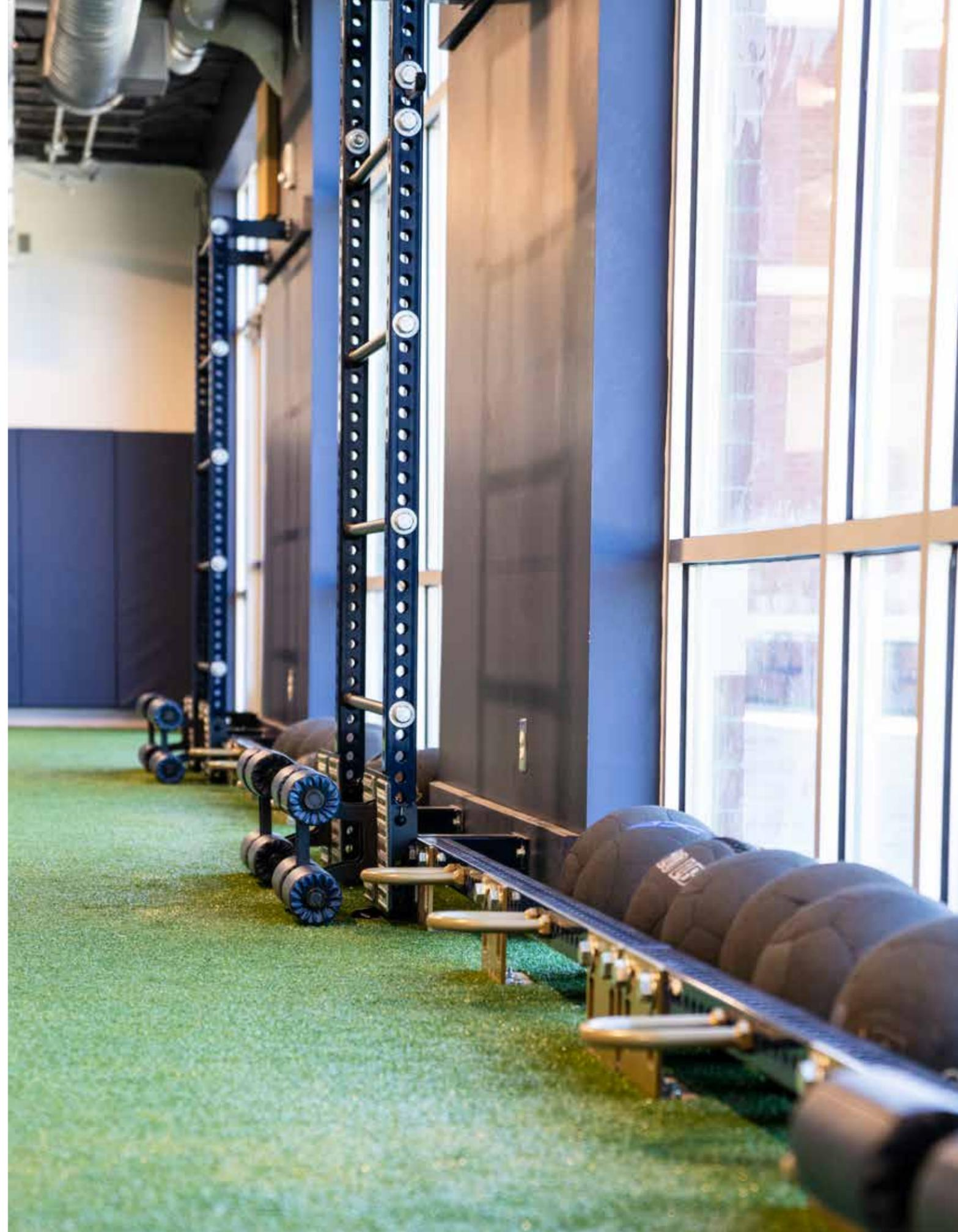



STASH HOOK™

DEPTH	3"
WIDTH	0.375"
HEIGHT	4"



SINGLE HOOK STORAGE

LENGTH	7.375"
WIDTH	1"
HEIGHT	4.5"

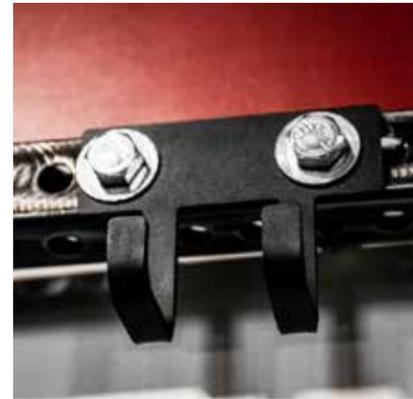

DOUBLE HOOK STORAGE

LENGTH	7.375"
WIDTH	9"
HEIGHT	3.75"



SINGLE BAR STORAGE

DEPTH	6.69"
WIDTH	9"
HEIGHT	5.13"



2-BAR STORAGE

LENGTH	15"
WIDTH	8"
HEIGHT	10"



FAT HOOK™

LENGTH	7"
WIDTH	3"
RACK ATTACHED FOR J'SQUAT STORAGE	



FIXED STEEL UTILITY PIN

LENGTH	6"
WIDTH	2"
WEIGHT	1 LB



ADJUSTABLE URETHANE UTILITY PIN

LOAD LENGTH	6" or 12"
DIAMETER	2"
WEIGHT	4 LB



FIXED URETHANE UTILITY PIN

LOAD LENGTH	12"
DIAMETER	2"
WEIGHT	5 LB



DEPTH	6"
WIDTH	18"
HEIGHT	3.5"

POOL CUE STYLE 4-BAR STORAGE

The Sorinex Pool Cue Style 4-Bar Storage is the best way to safely secure your barbells vertically in your rack or to mount them on the wall. The UHMW plastic layer helps protect your barbell from damage. Compatible with Sorinex Base Camp™, XL Series™, Iron Bear Multi Storage Unit or any 3" x 3" Rig with 1" holes and appropriate space.



BUMPER WING STORAGE

Attach to the outside of your Base Camp or XL Series racks for an efficient bumper and shelf storage. Customize the configuration specific to your needs. Bumper tray specs can be made exactly to your bumper width. Custom Colors Available.

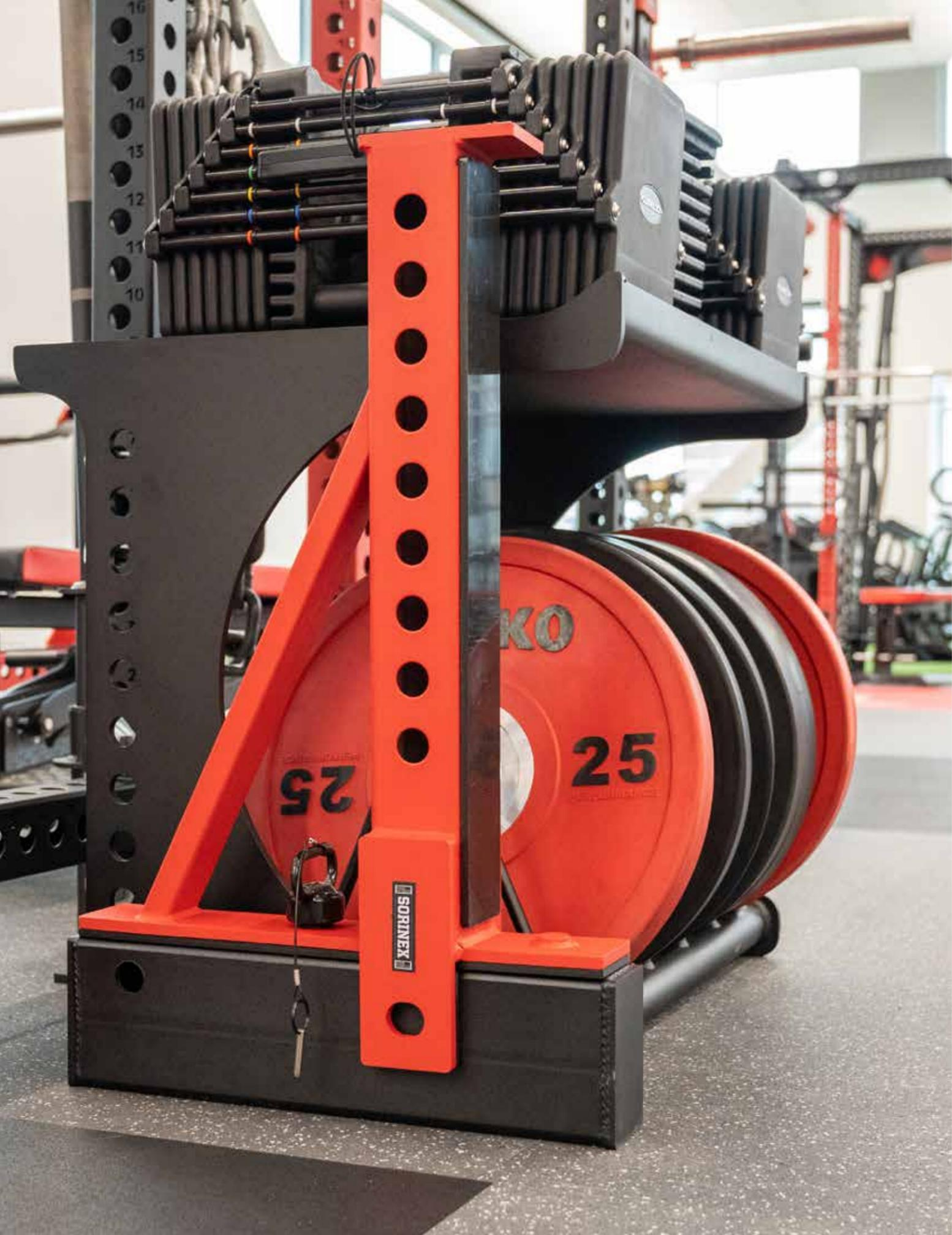

BUMPER WING STORAGE

DEPTH	CUSTOM
WIDTH	17"
HEIGHT	29"



BUMPER WING STORAGE W/ SHELF

DEPTH	14"
WIDTH	CUSTOM
HEIGHT	29"

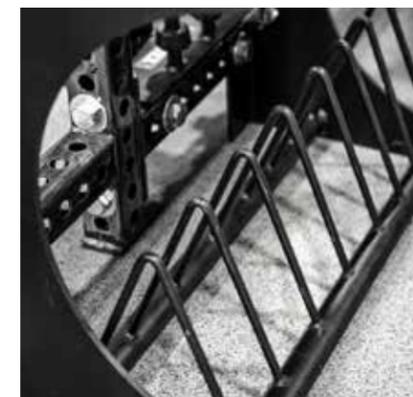

PREMIUM BUMPER STORAGE



STORAGE SHELF OPTION



ATTACH DIRECTLY OUTSIDE OF RACK



BENCHES

0-90 NP3™ ADJUSTABLE BENCH

The Sorinex NP3™ Adjustable Bench is adjustable to 6 positions; 0°, 15°, 30°, 45°, 60°, and 75°. Urethane wheels and an integrated vertical rubber storage stopper make this bench extremely versatile and easy to move in and out of working areas. The entire frame is constructed of 11-gauge and 7-gauge 2" square steel bent tubing with butt-type miter corners and 70,000 PSI full-pass mig welds. All open ends are capped with welded-on steel / rubber caps. All uprights are supported and gusseted for maximum integrity. All attachment bolts are 1/2" diameter grade #5 with anti-vibration locking systems. Wide set 10" bearing blocks for 3/4" pivot pin to ensure back pad stability and longevity. Flat stock, gravity-activated angle support. Bench pads are made with 3/4" birch plywood backboard with all corners and edges rounded; 1" thick high-density, non-moisture absorbing, closed-cell rebound foam covered with fully-sewn premium naugahyde leather.

LENGTH	58"
WIDTH	28"
HEIGHT	20"
WHEELS	URETHANE



INTEGRATED VERTICAL STORAGE



6 ADJUSTMENT ANGLES



BRANDED HEADGUARDS





**XL™ SERIES
COMPETITION BENCH**

LENGTH	66"
WIDTH	48"
HEIGHT	55.6"
BACK PAD SIZE	48.5" X 14.5"



AUTOSPOT BENCH

LENGTH	70"
WIDTH	71"
HEIGHT	47"
BACK PAD SIZE	48" X 14.5"



**INCLINE
COMPETITION BENCH**

LENGTH	66.5"
WIDTH	47"
HEIGHT	71.375"
BACK PAD SIZE	58" X 28"



**ADJUSTABLE DECLINE
SIT-UP BENCH**

LENGTH	62"
WIDTH	30"
MAX HEIGHT	41.25"
BACK PAD SIZE	48.5" X 12.25"



FLAT BENCH

LENGTH	48"
WIDTH	18"
HEIGHT	18"
BACK PAD SIZE	48" X 14"



**RECON ADJUSTABLE
BENCH**

LENGTH	55.4"
WIDTH	29"
HEIGHT	18"
BACK PAD SIZE	39" X 12"



DUMBBELLS & KETTLEBELLS

ARMOR SERIES URETHANE DUMBBELLS

Sorinex and Intek have partnered together to make the Sorinex Armor Series Urethane Dumbbells, our premier line of dumbbells. Each dumbbell is designed and encased in impact resistant premium urethane and integrated with an optional custom laser engraved multi-color logo inlaid within the urethane shell. Engineered to be durable in the harshest environments. Handles are press-fit and welded to produce a one-piece solid dumbbell. Your investment is protected with a 6 Year Warranty.

SIZES (LB)

5	10	15
20	25	30
35	40	45
50	55	60
65	70	75
80	85	90
95	100	105
110	115	120
125	130	135
140	145	150



CUSTOM COLOR AND LOGO OPTIONS



HARDENED CHROME ALLOY STEEL HANDLES WITH MEDIUM KNURLING



BLACK URETHANE COATING



CENTER MASS BELL®

The patented Sorinex Center Mass Bell® is a step above similar products; a modern interpretation of historically proven methods ranging from the 11th century India's Nal Stones to even the ancient Chinese art of black cauldron lifting.

We have perfected this cylindrical weight to balance in all three planes. The CMB offers the most simplistic form of external load and allows athletes to focus on natural gross loaded movement. This provides a shorter learning curve and a faster and more connected kinetic chain. For coaches and trainers, this will allow you to achieve the results you are looking for in a much shorter time, with less risk to your athletes.

The CMB is made with ductile iron as opposed to cast iron, which is more prone to cracking when dropped on hard surfaces. Ductile iron is a more expensive material, but we strive to ensure the highest quality with all our products. The CMB has a Limited Lifetime Warranty.



SIZES (LB)

5	10	15
20	25	30
35	40	45
50	60	70
80	90	100



DUCTILE IRON



LIFETIME WARRANTY



DUCTILE IRON KETTLEBELL

Cast in Indiana, The American Made Sorinex Ductile Iron Kettlebell is the top-tier kettlebell. Ductile Iron has twice the tensile strength of cast iron and a yield strength of 40k. This will prevent the cracking that can occur with cast iron when dropped. The Sorinex Ductile Iron Kettlebell has a 10 Year Warranty.

SPECIFICATIONS

MATERIAL	Ductile Iron
SIZES (KG)	4, 8, 12, 16, 20, 24, 28, 32, 36, 40
MADE IN USA	Yes



FEATURES



10 YEAR WARRANTY



E-COAT FINISH



AMERICAN MADE DUCTILE IRON





BUMPER S

BOSCO BUMPERS

The Sorinex Original Bosco Bumpers are unlike any other bumper on the market. Highest quality machined steel and urethane, made in North America to competition tolerances. These bumpers blend custom logos, short lead times, and a **LIFETIME WARRANTY**. Calibration allows for use in Olympic lifting or Powerlifting, and is used by some of America's strongest lifters. The bumper of the future is here, and only from Sorinex.



TOLERANCE

10 LB	DIA. 450mm +/- 1.0mm WEIGHT: -0 / +2.5%
25 LB	DIA. 450mm +/- 1.0mm WEIGHT: -.05 / +0.1%
45 LB	DIA. 450mm +/- 1.0mm WEIGHT: -.05 / +0.1%
HUB	4140 POLISHED STEEL
MATERIAL	ULTRA URETHANE
WARRANTY	LIFETIME

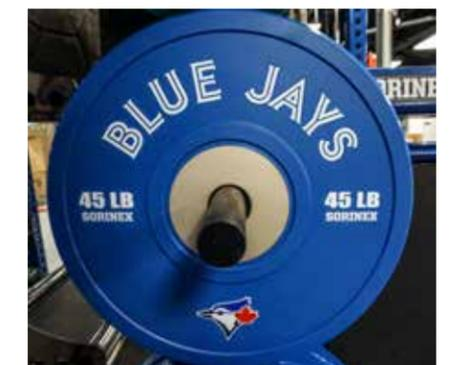
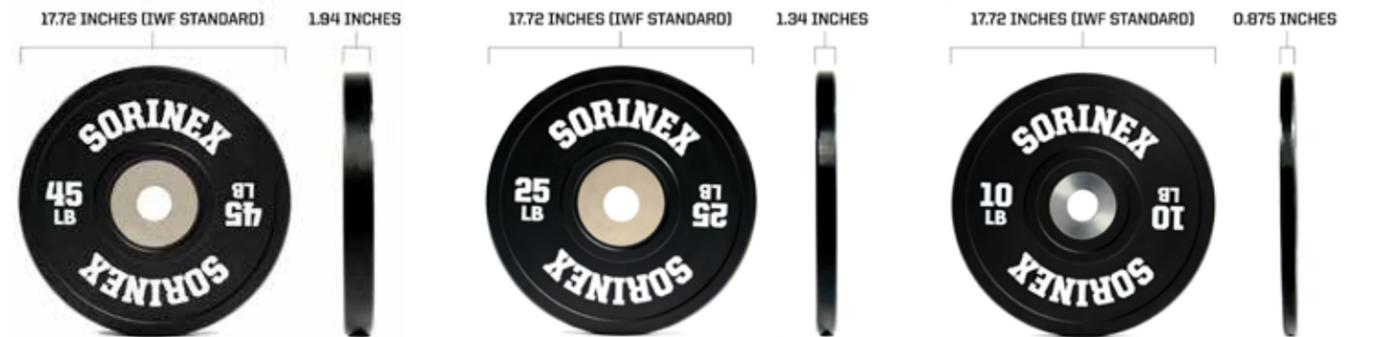

RECON® LITE BUMPERS

The 100% American Made Sorinex Recon Lite Bumper is an official bumper of the US Army Combat Fitness Test (ACFT). The innovative crumb rubber formula and manufacturing process creates a tougher and more durable bumper.

SPECIFICATIONS

WEIGHTS	10 LB, 15 LB, 25 LB, 35 LB, 45 LB
PLATE DIAMETER	17.72"
SLEEVE	STAINLESS STEEL
DUROMETER	85 +/-5
WEIGHT TOLERANCE	+/-2%
MATERIAL	CRUMB RUBBER
WARRANTY	1 YEAR LIMITED
MADE IN USA	YES

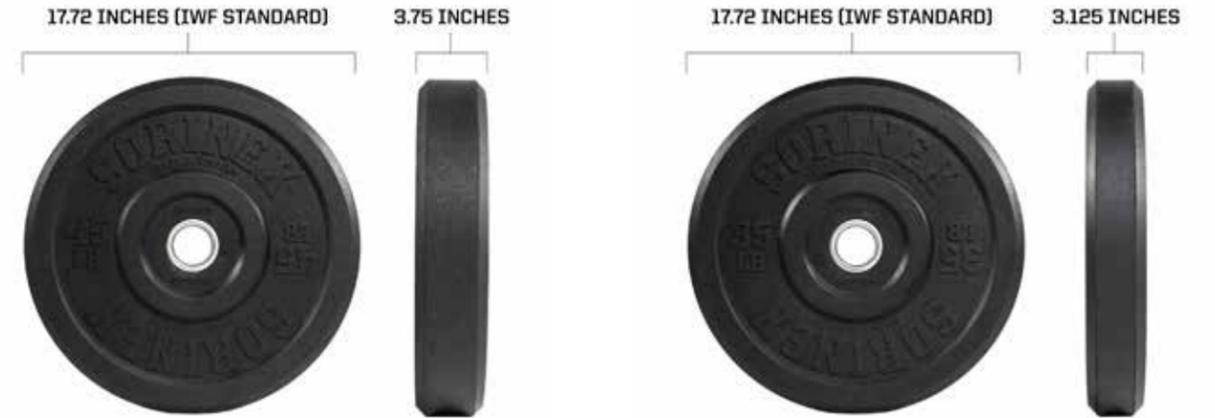

FEATURES



AN OFFICIAL BUMPER OF THE U.S. ARMY ACFT KIT



PROPRIETARY CRUMB RUBBER FORMULA



STAINLESS STEEL SLEEVE



B A R S

SORINEX STANDARD SERIES PERFORMANCE BAR

The Sorinex Performance Bar is our favorite all-around barbell. Simplified and perfected performance that you can rely on. Clear bright zinc, one-piece sleeves are pressed, machined and plated for high-performance output and strength. Built to International Weightlifting Specifications. The Sorinex Performance Bar has upgraded bronze bushings & more aggressive medium knurl pattern. A noticeably positive difference when performing Olympic Lifts. The Performance Bar Shaft (190K PSI) comes in either Black Zinc or Bright Clear Zinc coating. 100% Made in the USA. Custom options available.

WEIGHT	10, 15, OR 20 KG
DIAMETER	25 MM / 28.5 MM
SLEEVE LENGTH	16.5"
KNURLING	LIGHT / MEDIUM KNURLING
CENTER KNURL	NO
SHAFT COATING	BRIGHT ZINC OR BLACK OXIDE
TENSILE STRENGTH	155,000 PSI or 190,000 PSI
STATIC LOAD	2,000 LB TESTED
CONSTRUCTION	PRESSED, MACHINED, AND PLATED
BUSHING / BEARING	BRONZE BUSHINGS



BLACK OXIDE OR BRIGHT ZINC

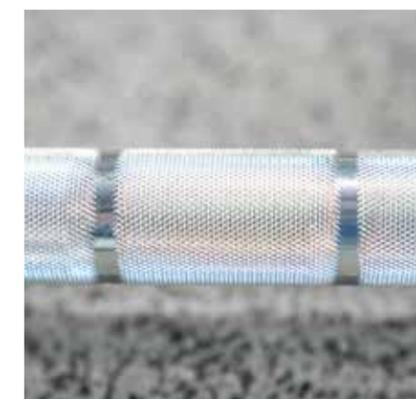

OLYMPIC AND POWER LIFTING MARKS ON LIGHT / MEDIUM KNURLING



ALSO AVAILABLE IN 10KG AND 15KG

SORINEX STANDARD SERIES BOSCO™ POWER BAR

The Sorinex Standard Series Bosco™ Power Bar is our standard power lifting bar. It comes in Black Zinc or Black Cerakote. The Bosco™ Power Bar has a medium aggressive knurling, a center knurl and power lifting knurl marks. It has a tensile strength of 190,000 PSI and has self lubricating bronze bushings. 100% Made in the USA. Custom colors and branding available.



WEIGHT	20 KG
DIAMETER	28.5 MM
SLEEVE LENGTH	16.5"
KNURLING	MEDIUM / AGGRESSIVE KNURLING
CENTER KNURL	YES
SHAFT COATING	BLACK ZINC OR BLACK CERAKOTE
TENSILE STRENGTH	190,000 PSI
STATIC LOAD	2,000 LB TESTED
CONSTRUCTION	PRESSED, MACHINED, AND PLATED
BUSHING / BEARING	SELF LUBRICATING BRONZE BUSHINGS



2000 LB STATIC LOAD TESTED

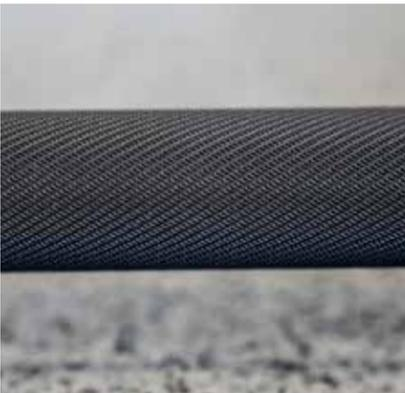

MEDIUM / AGGRESSIVE KNURLING



BLACK ZINC OR BLACK CERAKOTE



SORINEX STANDARD SERIES OLYMPIC NEEDLE BAR

The Sorinex Standard Series Olympic Needle Bar is our standard olympic lifting bar. It comes in Bright Zinc or Clear Cerakote. The Clear Cerakote finish is bead blasted giving it that gray hue. It is made to IWF standards. The Olympic Needle Bar has a light knurling and olympic knurl marks. It has a tensile strength of 190,000 PSI and has 10 precision ING Needle Bearings, 5 in each end. 100% Made in the USA. Custom colors and branding available.

WEIGHT	20 KG
DIAMETER	28 MM
SLEEVE LENGTH	16.5"
KNURLING	LIGHT KNURLING
CENTER KNURL	NO
SHAFT COATING	BRIGHT ZINC OR CLEAR CERAKOTE
TENSILE STRENGTH	190,000 PSI
STATIC LOAD	2,000 LB TESTED
CONSTRUCTION	PRESSED, MACHINED, AND PLATED
BUSHING / BEARING	10 PRECISION ING NEEDLE BEARINGS



BUILT TO IWF STANDARD

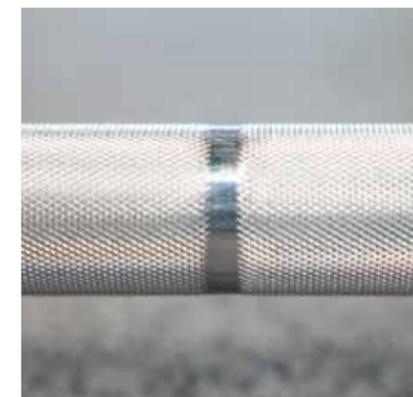

LIGHT KNURLING



BRIGHT ZINC OR CLEAR CERAKOTE

OX™ SQUAT BAR

The Sorinex Original Ox Squat Bar was designed to be the best cambered squat bar on the market. Unlike other cambered bars that curve, the specific 10-degree bar break minimizes cervical spinal loading. The sleeves are fixed and parallel to the ground. Other cambered bars pitch up causing your body to compensate and tilt forward. It boasts a larger shaft diameter and longer length for increased hand placement options.

LENGTH	92.5"
DIAMETER	1.5"
WEIGHT	45 LBS
FINISH	BLACK TEXTURE POWDER
SLEEVE CONSTRUCTION	WELDED
SLEEVE LENGTH	16"
BUSHING / BEARING	FIXED



DECREASED LOAD ON CERVICAL SPINE



10 DEGREE BREAK



PARALLEL SLEEVE ANGLE TO GROUND

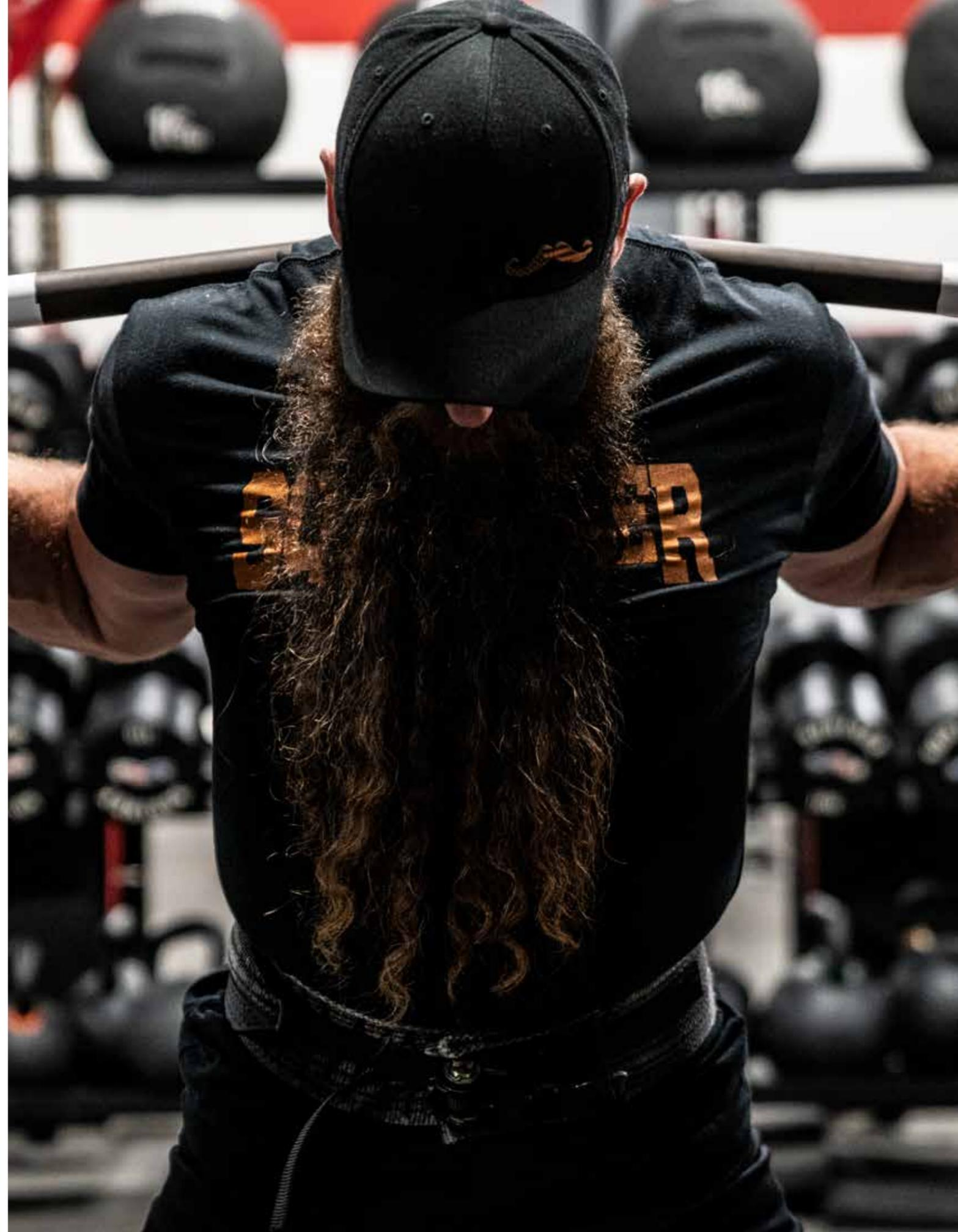

MULTI-GRIP BAR

The Sorinex Multi-Grip Bar features 8 different grip locations that allow you to press or pull in a neutral, wide, or angled position. Otherwise known as a "Football Bar", the Multi-Grip bar is a standard tool in strength programs looking to minimize shoulder stress during bench or overhead pressing movements. The Multi-Grip bar, similar to all Sorinex Specialty Bars, will accept all bumper or weight plates while conveniently storing in your rack, rig, or Iron Bear™ Storage unit.

LENGTH	85.5"
SLEEVE DIAMETER	1.5"
SLEEVE LENGTH	16"
WEIGHT	50 LBS
KNURLING	MEDIUM GRADE



VERTICAL AND ANGLED HANDLES



EASILY SWITCH FROM NARROW TO WIDE GRIP



MEDIUM GRADE KNURLING

DIAMOND BAR

The Sorinex Diamond Bar is an industry first and Sorinex Original. Designed in 2002 when President/CEO Bert Sorin needed his trap bar (hex bar) to work within the rack to overhead press, but existing models were too short. The Sorinex Diamond Bar was born and became the first of its kind long enough (16-inch sleeves) to integrate into a rack. The Double Handle Diamond Bar features varied pulling positions that are easy to use by simply flipping the Diamond Bar over. Pull, press, deadlifts, shrugs, carries and more.

LENGTH	86.625"
WIDTH	27.625"
HANDLE	SINGLE HANDLE OR DOUBLE HANDLE
RAISED HANDLE HEIGHT	6"
SLEEVE LENGTH	16"
WEIGHT	60 LB 70 LB (DOUBLE)



DOUBLE HANDLE DESIGN



THE INDUSTRY'S FIRST RACKABLE TRAP BAR



SINGLE HANDLE DESIGN



PREFERRED TRAP BAR OF THE ARMY ACFT
PHOTO COURTESY OF VOANEWS.COM | AP

LOG BAR

The Sorinex Log Bar offerings come with fully knurled parallel handles. They fit in standard Sandwich J-Hooks and are perfect for log press training. Three sizes and a training bar are available ranging from 40 lbs to 110 lbs to fit the needs of any individual. A must have for strongman training.

LENGTH	84"
TRAINING WEIGHT	40 LBS
6" WEIGHT	57 LBS
8" WEIGHT	62 LBS
10" WEIGHT	110 LBS
DIAMETER	1.12", 6", 8", 10"
SLEEVE LENGTH	16" (12" FOR 10" BAR)



10" DIAMETER LOG BAR



8" DIAMETER LOG BAR



6" DIAMETER LOG BAR



LOG TRAINING BAR



SAXON BAR

The Sorinex Saxon Bar is the ultimate pinch grip bar. Two grip widths to work narrow and wide pinching, taxing not only the fingers but the thumb, as well. A bar that strongman legend Arthur Saxon would have been proud of.

LENGTH	89"
WEIGHT	44 LBS
DIAMETER	3", 4"
SLEEVE LENGTH	14"
BUSHING / BEARING	FIXED
FINISH	RAW OR BLACK TEXTURE POWDER



3" GRIP



4" GRIP



ACCEPTS ANY STANDARD OLYMPIC BARBELL PLATE



SAFETY SQUAT BAR

LENGTH	87.5"
DEPTH	7"
HEIGHT	17"
WEIGHT	50 LBS
SLEEVE	2" DIA., 16" LENGTH



FAT BAR

LENGTH	84"
WEIGHT	32 LBS
DIAMETER	2"
SLEEVE LENGTH	15.75"
BUSHING / BEARING	FIXED



COOL BREEZE CAMBER BAR

LENGTH	91"
CAMBER DROP	14"
DIAMETER	2"
WEIGHT	45 LBS



RECON BAR

LENGTH	52"
WEIGHT	50 LBS
DIAMETER	28.5"
SLEEVE LENGTH	16.5"
COLLAPSIBLE	YES



ACCESSORIES

BANDS & CHAINS
BARBELL ACCESSORIES
BOXES & BLOCKS
CONDITIONING
SLEDS & STRAPS



LARGE STRENGTH BANDS

LENGTH	41"
ORANGE: APPROX 5-15 LBS	RED: APPROX 20-25LBS
MINI BLACK: APPROX 30-50LBS	PURPLE APPROX 40-80LBS
GREEN: APPROX 50-120LBS	BLUE: APPROX 60-510LBS
MONSTER BLACK: APPROX 80-200LBS	



SHORT STRENGTH BANDS

LENGTH	12"
RED: APPROX 20-25LBS	PURPLE APPROX 40-80LBS
GREEN: APPROX 50-120LBS	BLUE: APPROX 60-510LBS



DAISY CHAINS

LENGTH	38"
LOOP DIAMETER	4"
MATERIAL	1" Nylon Webbing Double Stitched



TOP SQUAT

HANDLE LENGTH	22.5"
WIDTH	36.5"
WEIGHT	14 LBS



BAR LOCKS

LENGTH	14.5"
WIDTH	8"
THICKNESS	1"
MATERIAL	HDPE



STANDARD SPRING COLLARS

DIAMETER	2"
MATERIAL	STAINLESS STEEL



CHAIN SET

WEIGHT	30 LBS, 45 LBS
THICKNESS	1/2" 5/8"
MATERIAL	STEEL



MONSTER CHAINS

WEIGHT	45 LBS
THICKNESS	5/8"
MATERIAL	CORDURA WRAPPED STEEL



MONSTER CHAIN HOOKS

LENGTH	9"
FITS	STANDARD OLYMPIC BAR
WEIGHT	10 LBS



PROLOC™ 1 COLLARS

HEIGHT	3"
DIAMETER	1.937" - 2.007"
MAGNETIC OPTION	YES
MATERIAL	6,6 NYLON COMMERCIAL GRADE



SPECIALTY BAR SPRING COLLARS

DIAMETER	1.92"
MATERIAL	STAINLESS STEEL

**** DOES NOT FIT ON STANDARD BARBELLS,
SPECIALTY BARS ONLY**



HUSKER POWER LOCK COLLARS

LENGTH	5.5"
FITS	STANDARD OLYMPIC BAR
WEIGHT	2 LBS
MATERIAL	PLASTIC NYLON

MEAT HOOK® HANDLE

Quickly attach the patented Sorinex Meat Hook® Handles to a Sorinex Diamond Bar for 3" and 6" higher handles. Minimize the need for blocks and special bars to pull from variable heights. Knurled 1.25" handles are a medium knurl ideal for pulls and carrying movements. Black texture powder coat provides a durable finish.

LENGTH	9"
WIDTH	8.75"
HANDLE	KNURLED 1.25"
WEIGHT	5 LBS EA



DUAL HEIGHT OPTIONS



KNURLED HANDLES



ATTACH TO SORINEX DIAMOND BAR FOR 3" AND 6" HIGHER HANDLES

DEADLIFT JACK

The Sorinex Deadlift Jack allows you to load and unload weight to your bar from the ground with ease. Using the single jack or double jack with a rubber grip handle, place the bar on the jack and tilt it back to securely rack your bar. The jack is made of HDPE plastic to protect the bar from wear and tear over time.

SINGLE LENGTH	19"
SINGLE THICKNESS	3.2"
SINGLE HEIGHT	12.5"
DOUBLE LENGTH	30"
DOUBLE WIDTH	44.75"
DOUBLE HEIGHT	23"



SINGLE JACK



DOUBLE JACK



LOAD AND UNLOAD BAR WITH EASE

BLOCK CONNECTOR PLATE

Connect your blocks in 6" and 12" groups with the Block Connector Plate set. Easily move from station to station with black urethane wheels with ABEC bearings.

DEPTH	3.75"
WIDTH	14.75"
HEIGHT	5.5" (6" Block) 11.5" (12" Block)
WEIGHT	6 LBS (6" Block) 11.5 LBS (12" Block)
MATERIAL	1/4" Steel



FEATURES



CONNECT YOUR BLOCKS IN 6" AND 12" GROUPS



CUSTOM LOGOS AVAILABLE



BLACK URETHANE WHEELS WITH ABEC BEARINGS



UPGRADE BY ADDING NAUGHYDE PADS



LASER CUT BRANDING AND SIZES



HANDLES TO EASILY TRANSPORT





COLLEGIATE SOFT PLYO BOX SET

Made with super dense foam, the Collegiate Soft Plyo Boxes will hold up to with heavy use. Perfect for box jumps and plyometric exercises. Strong velcro flaps on the sides of each box prevents slipping while making it easy to remove and stack boxes.



STRONG VELCRO STRAPS TO PREVENT SLIPPING



CUSTOM LOGO OPTIONS AVAILABLE

HEIGHT	6" 12" 18" 24"
WEIGHT	36 LB 62 LB 98 LB 118 LB
DEPTH	30"
WIDTH	36"
MATERIAL	DENSE, HEAVY FOAM



FLAT PACK PLYO BOX

LENGTH	30"
WIDTH	20"
HEIGHT	24"
WEIGHT	33 LBS



STEEL PLYO BOX SETS

HEIGHT	UP TO 42"
WEIGHT	23.5 - 48.75 LBS



WAR HAMMER™

LENGTH	37.5"
WIDTH	8"
DIAMETER	1.5" x 2"



RUSSIAN WEDGE

LENGTH	52"
WIDTH	36"
HEIGHT	28.5"
ANGLE	30°



SQUAT BOX

LENGTH	24"
WIDTH	24"
HEIGHT	11" - 17"
WEIGHT	80 LBS

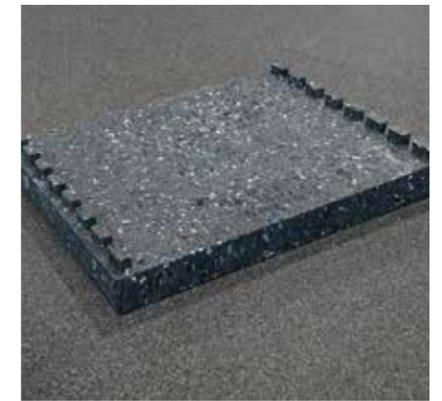

DC BLOCK

LENGTH	19"
WIDTH	15.5"
HEIGHT	2"
MATERIAL	IMPACT-RESISTANT INJECTED PLASTIC



RUBBER UTILITY BLOCK

LENGTH	24"
WIDTH	12"
HEIGHT	9"
WEIGHT	72 LBS



RUBBER SQUAT WEDGE

LENGTH	39.5"
WIDTH	8"
HEIGHT	2"



JERK BLOCKS

LENGTH	30.75"
WIDTH	24"
HEIGHT	50" - 24"
WEIGHT	258 LB EACH



SANDMINE® SANDBAG

DIAMETER	16"
THICKNESS	3"
MATERIAL	XD™ DUPONT™ KEVLAR®



SLAM BALLS

10 - 20 LB DIAMETER	9"
25 - 50 LB DIAMETER	11"
50 - 100 LB DIAMETER	14"
100 - 150 LB DIAMETER	15"
MATERIAL	HIGH TEXTURED PVC



INERTIA WAVE

LENGTH	9.5'
TUBE DIAMETER	2"
WEIGHT	2.5 LBS



DELTA™ SLED

LENGTH	37"
WIDTH	24"
HEIGHT	30"
WEIGHT	40 LBS



SPEED™ SLED

LENGTH	20"
WIDTH	8"
HEIGHT	6"
WEIGHT	18 LBS



ROOT HOG SLED

LENGTH	39"
SLED HEIGHT	3"
PUSH UPRIGHT HEIGHT	26"
LAWNMOWER HANDLE LENGTH	41"



RAPTOR WEIGHT VEST

SIZE	Elite 15: S-M Elite 20: L-XXL
MAX TRAINING WEIGHT	Elite 15: 15 KG Elite 20: 20 KG



TACTICAL TRAINING PLATE

LENGTH	12.25"
WIDTH	10.5"
WEIGHT	5 LB 7 LB 10 LB



TACTICAL LOAD TRAINER

LENGTH	8.2"
LOAD LENGTH	5.25"
WIDTH	13"



S.I.T.T.® SLED

LENGTH	47.5"
WIDTH	29"
WEIGHT	70.5 LBS



92" STRAP

LENGTH	92"
WIDTH	1"
WEIGHT	1 LB
MATERIAL	DURABLE WEBBING



UTILITY STRAPS

LENGTH	9"
WIDTH	1"
MATERIAL	DURABLE WEBBING



GRIP TRAINING

MIGHTY MITTS™ PINCH BLOCKS

Sorinex Original Mighty Mitts™ Pinch Blocks are a great way to load and develop pinching strength and grip strength. The width of the block is available in 2, 3, or 4" options. Attach a strap and use for pull-ups or with kettlebells and barbells. Use them with a Mighty Mitts™ Loading Pin, cable machine, or in conjunction with a Root Hog™ Sled to develop killer pinching strength.

LENGTH	6"
HEIGHT	5.5"
MATERIAL	11 GAUGE STEEL



2"



3"



4"

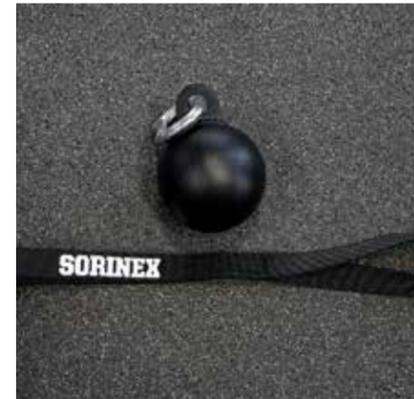

MIGHTY MITTS™ HAND GRENADE

DIAMETER	3" OR 4"
----------	----------

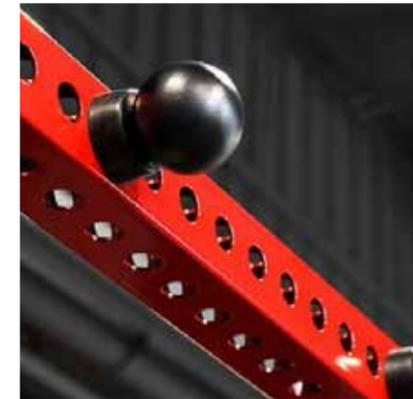

MIGHTY MITTS™ RACK BALL

LENGTH	8"
DIAMETER	3" OR 4"



MIGHTY MITTS™ CANNON LAT BAR

LENGTH	30" OR 42"
BAR DIAMETER	2"
BALL DIAMETER	3"



MIGHTY MITTS™ HUB LIFT

DIAMETER	2"
HEIGHT	3.75"



MIGHTY MITTS™ LOADING PIN

LENGTH	13.875"
DIAMETER	2"
WEIGHT	6 LBS
FITS	OLYMPIC PLATES



MIGHTY MITTS™ FAT ROTATING HANDLE

LENGTH	6.375"
WIDTH	8.5"
GRIP DIAMETER	2"

CLAM SHELL™ GRIP

The patent pending Clam Shell™ grip is a totally unique and portable way to develop pinching muscles of the hands and forearms. It can be thrown in your gym bag and brought to any gym in America using existing dumbbells for resistance. It can be used single or in pairs on any standard dumbbell handle and can also be used in pairs on a barbell shaft. Trains exceptionally well with the Sorinex Saxon Bar. The precision bronze bearings gives a premium opening and closing motion to closely follow your grip.

THICKNESS	3" OR 4"
WIDTH	4.25"
HEIGHT	7.5"
WEIGHT	7 LBS 8 LBS
MATERIAL	SOLID 3/8" STEEL



AVAILABLE IN 3" OR 4" THICKNESS



APPROVED BY ARMLIFTING USA



CAN BE USED SINGLE OR IN PAIRS ON A BARBELL SHAFT





**MIGHTY MITTS™
FAT VERTICAL
HANDLE**

LENGTH	7.5"
DIAMETER	2"



**MIGHTY MITTS™
POP'S GRIPPER**

LENGTH	17"
WIDTH	27.5"
HEIGHT	23.75"
WEIGHT	42 LBS



**CRUSHBOOSTER™
GRIP ATTACHMENT**

FITS	POPS GRIPPER ONLY
------	-------------------



**FIREBREATHER
RINGS**

WIDTH	9"
WEIGHT	6 LBS
DIAMETER	1.25"



RECON RINGS

LENGTH	16"
WEIGHT	5 LBS
DIAMETER	2"



THE BALLISTICA

LENGTH	24"
WIDTH	4"
WEIGHT	10 LBS
FITS	OLYMPIC PLATES



**MIGHTY MITTS™
GRIP CHALK**

SIZE	5.5 OZ BLOCK
1 LB BOX	3 BLOCKS (5.5 OZ)



**MIGHTY MITTS™
ANVIL TRAINER**

WIDTH	TAPERS OUT TO 3.75"
HEIGHT	23.5"



**FARMERS WALK
HANDLES**

LENGTH	60"
WEIGHT	27 LBS EACH
HANDLE DIAMETER	1.25"

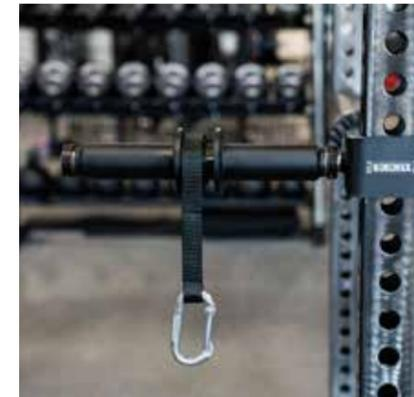

WRIST ROLLER

LENGTH	19.5"
HANDLE WIDTH	4.75"
HANDLE DIAMETER	2"
WEIGHT	15 LBS

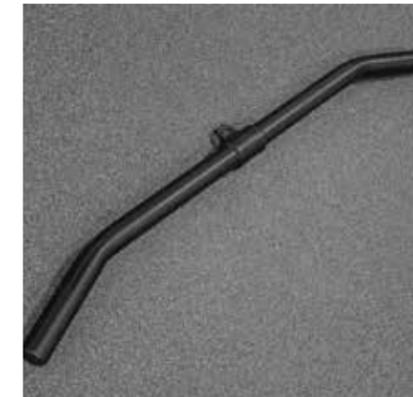

**BENT LAT BAR
WITH SWIVEL**

LENGTH	48"
DIAMETER	2"



PARALLETTES

LENGTH	24"
HEIGHT	13.03"
DIAMETER	1.25"
WEIGHT	19 LBS EACH

MIGHTY MITTS™ FAT CHIN TRIANGLE

The Sorinex Original Mighty Mitts Fat Chin Triangle" handles provide a superior grip training experience. Use with your favorite cable machine for rows or strap it to a standard chin bar for close-grip fat chin work.

LENGTH	9"
DIAMETER	2"
LASER CUT LOGO	OPTIONAL



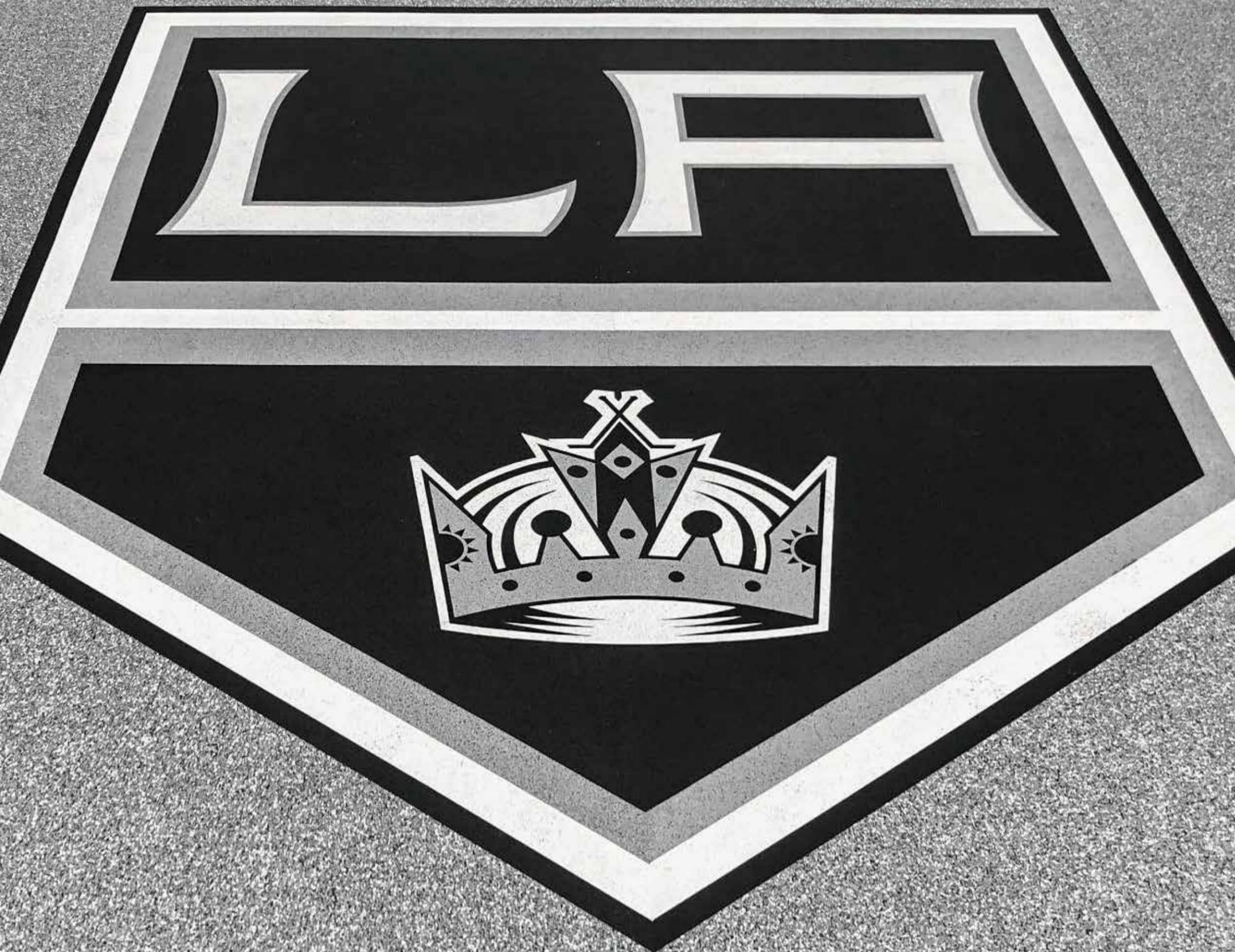

FLOORING

Countless hours of research and development between the top coaches, athletes, the Ecore manufacturing team, and the Sorinex team have been dedicated to improving and simplifying the product, process, and customer experience with elite performance flooring and an industry leading warranty.

LEGENDARY SERIES™
FLOORING | **SORINEX** | **ecore**



INNOVATION

Countless hours of research and development between the top coaches, athletes, the Ecore manufacturing team and the Sorinex team have been dedicated to improving and simplifying the product, process, and customer experience with elite performance flooring. We have tested numerous color patterns to find the most aesthetically refined and resilient options. We have optimized product thickness to exceed current industry standards. No misleading names or descriptions for you to play with, simplifying your choice between our 0.5 inch and 1 inch flooring solutions. We back all of this up with an industry leading 8 and 16 year manufacturer's warranty.

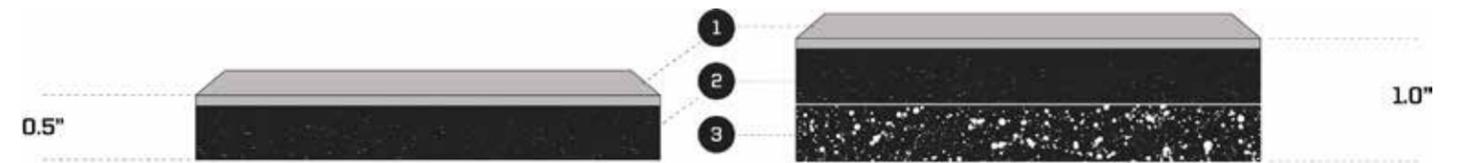

HISTORY

Since 1980, Sorinex has designed the most innovative and versatile weight rooms in strength and conditioning. During these years we have been constantly underwhelmed with the flooring options and the lack of durability and toughness claimed. To find the best solution to this problem Sorinex has partnered with Ecore Athletic, a division of Ecore, one of the largest flooring manufacturers in the United States. The deep history of the two companies spans over 120 years in strength training and the flooring industry. Since 1871, Ecore has been transforming reclaimed materials into unique products. What started with simple cork closures has evolved into a diverse portfolio of products solving complex problems in applications ranging from weight rooms and turf fields to some of the toughest training environments. Sorinex and Ecore believe that floors should elevate beyond current expectations and have created a flooring line well beyond industry standards. With unsurpassed durability, innovation and an industry leading warranty, we created a product that aligns optimal force reduction with a balanced amount of energy return to create dynamic surfaces that cater to the athlete and the application.

1

WEAR LAYER

With the thickest wear layer available to our industry, this vulcanized EPDM rubber withstands the most common wear and tear seen among the weight room environment. Factory laminated to our base performance layer for slip resistant, life-long durability, and easy maintenance.

2

BASE LAYER

The 0.5" Legendary product features a dense base layer perfecting the balance between force reduction and energy return. Factory laminated to our resilient wear layer, this dual durometer system is built to last for strength training applications.

3

UNDERLAYMENT

This 0.5" upgrade accentuates safety and longevity in performance surfacing. Our base layer is combined with our half inch underlayment to create the Legendary 1" triple durometer system for unmatched performance, second to none.

BRANDED SOLUTIONS FROM THE GROUND UP



Make a strong impression and separate yourself from the crowd with unique branding options specific to the Legendary Series flooring line. Make your statement bold or subtle, by incorporating your logo, colors, and brand statements in to the floor, platforms, and base boards. Each unique branding element is water jet cut to ensure extreme detail and seamless accuracy. Pair your branded floor with the laser cut branded steel components of Sorinex equipment to create a one-of-a-kind facility.



SAFETY

Mitigating injury related to impact through shock absorption & slip resistance.



ERGONOMICS

Alleviating negative stress of impact and fatigue.



ACOUSTICS

Minimizing structure born noise and surface generated noise. IIC, STC, NRC.



FORCE REDUCTION
40%
ENERGY RESTITUTION
53%



WARRANTY

Industry leading 8 and 16 year warranty.

EXCLUSIVE LEGENDARY SERIES™ COLOR OPTIONS



ASH



SMOKE



GUN METAL



MIDNIGHT

LEGENDARY SERIES™ ONE INCH FLOORING

Custom engineered triple durometer system physically cultured to the Sorinex standard. This Legendary 25.2mm system features our 13.2mm dual laminated vulcanized rubber combined with a 12mm shockpad to provide the highest quality performance rolled rubber available in the strength and conditioning industry. Delivering a higher force reduction rate to exceed the ergonomic demands of today's training environment. Built to last, powered by Ecore.

THICKNESS	1.0"
DESCRIPTION	13.2mm Heat Fused Dual Layer + 12mm Shockpad
CUSTOMIZE	Water jet cut options available for logos, platforms, ladders, etc.
APPLICATION	Weight room, multipurpose fitness, tactical training, rehabilitation, functional workplace environments, etc.
WARRANTY	16 Year Manufacturer's Warranty



PERFORMANCE CRITERIA	TEST METHOD	RESULT
Tensile Strength	ASTM D 412	>200 PSI
Flexibility 1/4" Mandrel	ASTM F 137	Pass
Thermal Conductivity	ASTM C 518	2.1 Btu-in/h-ft-F
Static Load Limit	ASTM F 970 @ 250PS	0.004" Pass
Coefficient of Friction	ASTM D 2047	>0.9
V.O.C. Compliant	ASTM D 5116	Yes
Abrasion Resistance	ASTM D 3389 / EN 649	<1g, 1000 cycle
Resistance to Heat	ASTM F 1514	Δ E <8.0
Pill Test	ASTM D 2859	Pass
Vertical Deflection / Deformation	ASTM F 2772	1.6mm
Surface Effect Slip Resistance	ASTM F 2772	92
Ball Rebound	ASTM F 2772	100%
Force Reduction	ASTM F 2772	40%
Sheet Dimension	Manufacturer	4' width by Minimum length of 25 LF

LEGENDARY SERIES™ HALF INCH FLOORING

Custom engineered dual durometer system built for athletes by athletes. The Legendary 13.2mm product is created through a formulation of high quality post-consumer vulcanized rubber, factory laminated to an EPDM wear layer. Designed to reach the ergonomic needs of high impact training, this slip resistant surface delivers long term durability with low maintenance care. Built to last, powered by Ecore.

THICKNESS	0.5"
DESCRIPTION	3.2mm EPDM wear layer heat fused to 10mm backing system
CUSTOMIZE	Water jet cut options available for logos, platforms, ladders, etc.
APPLICATION	Weight room, multipurpose fitness, tactical training, rehabilitation, functional workplace environments, etc.
WARRANTY	8 Year Manufacturer's Warranty



PERFORMANCE CRITERIA	TEST METHOD	RESULT
Tensile Strength	ASTM D 412	>200 PSI
Flexibility 1/4" Mandrel	ASTM F 137	Pass
Thermal Conductivity	ASTM C 518	2.1 Btu-in/h-ft-F
Static Load Limit	ASTM F 970 @ 250PS	0.004" Pass
Coefficient of Friction	ASTM D 2047	>0.9
V.O.C. Compliant	ASTM D 5116	Yes
Abrasion Resistance	ASTM D 3389 / EN 649	<1g, 1000 cycle
Resistance to Heat	ASTM F 1514	Δ E <8.0
Pill Test	ASTM D 2859	Pass
Vertical Deflection / Deformation	ASTM F 2772	0.5mm
Surface Effect Slip Resistance	ASTM F 2772	Pass
Ball Rebound	ASTM F 2772	100%
Force Reduction	ASTM F 2772	10%
Sheet Dimension	Manufacturer	4' width by Minimum length of 25 LF



**MOBILITY &
RECOVERY**

RECOVERY RACK

The Sorinex Recovery Rack is a multi-purpose solution with a focus on mobility and storage. The 4-Way hole design accepts all Sorinex attachments and accessories. Custom configure to any height, length, size, or application.

DEPTH	47"
WIDTH	47"
HEIGHT	95.4
MATERIAL	11 GAUGE STEEL



CALF / PLANTAR FASCIA STRETCHER, TRIGGER ROLLER / BARS, PVC HURDLE PIPES

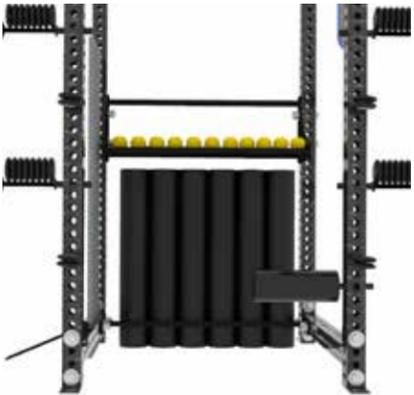

HD FOAM ROLLERS, SINGLE LEG ROLLER PADS, LACROSSE BALLS

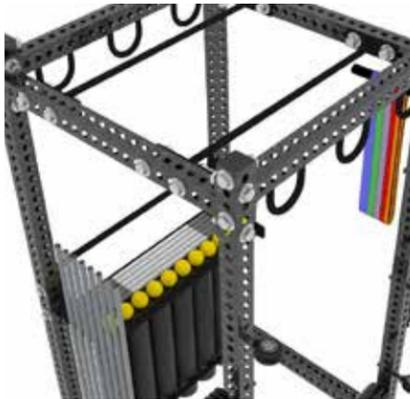

CHIN BARS, STRETCH LOOPS, BIG STICK RECOVERY TOOLS, STORAGE SHELF



MOBILITY MAKER BENCH

The Mobility Maker Bench, designed by pro sports mobility coach Dana Santas, is the most versatile training bench ever created. Its durable, fully adjustable saddle and frame provide the support and means for anyone (of virtually any size, shape or ability) to mobilize their entire body without needing multiple pieces of equipment. The MM Bench is essentially the "Swiss Army Knife" of training as it supports dozens of mobility exercises other equipment can't, while also providing the benefits of a split-squat stand, hip thruster, and roman chair.



LENGTH	57"
WIDTH	30.5"
HEIGHT	22.7"



INTEGRATED VERTICAL STORAGE



PREMIUM NAUGAHYDE LEATHER



FULLY ADJUSTABLE SADDLE

MOBILITY AND RECOVERY



TRIGGER ROLLER

LENGTH	11.5"
WIDTH	3.25"
WHEELS	URETHANE



TRIGGER BAR

LENGTH	24.125"
WIDTH	4.75"
WHEELS	URETHANE



FOAM ROLLER

LENGTH	36"
DIAMETER	6"
WEIGHT	< 1 LB
MATERIAL	HIGH-DENSITY FOAM



THERAPY TABLE

The Sorinex Therapy Table is a heavy duty and versatile training table solution. The storage compartment underneath holds foam rollers, mobility tools and accessories. The 4-Way Hole design allows you to use Sorinex attachments or connect tables together. Add custom logos and colors for a branded aesthetic. Adjustable back pad is optional.

LENGTH	74"
WIDTH	36"
TABLE HEIGHT	34.19"
FULL HEIGHT	71"



STORAGE COMPARTMENT UNDER TABLE



DOUBLE STITCHED NAUGAHYDE

COOLER SLEEP SYSTEM WITH CHILI COOL MESH™

The COOLER is our most advanced and most luxurious sleep system with a hydro-powered thermal range that operates from 55-115°F (13-46°C). It includes our reversible Chili Cool Mesh™ pad, ergonomic control unit(s) and COOLER app for a truly customized sleep experience. Half sizes recommended for individuals, full sizes for couples. FREE SHIPPING and 2 YEAR WARRANTY.

CONTROL UNIT SPECIFICATIONS

DIMENSIONS	15" x 10" x 6"
WATER TANK	30 oz (900ml)
VOLTAGE	100-240 VAC 50Hz / 60Hz
WATTS	140W
TEMP RANGE	55-115°F

HYDRONIC PAD SPECIFICATIONS

SIZE	Half Queen - Cal King
PAD THICKNESS	1/4 in.
SURFACE FIBERS	Poly-Cotton Blend
INTERNAL DESIGN	1/8 in. Silicone Tubing
BOTTOM MATERIAL	Poly-Cotton Blend
CONNECTION	8 ft. Tubing



COOLER APP FOR CUSTOMIZABLE SLEEP EXPERIENCE



UTILIZES HYDROPOWER TO CONTROL TEMPERATURE FROM 55-115°F





TESTING & TRACKING

TENDO POWER ANALYZER

Sorinex is the exclusive American Distributor of Tendo.

Tendo Power Analyzer Measures and Calculates:

- Average Power, Partial Average Power, and Peak Power (for Power training)
- Peak Velocity for Olympic lift exercises
- Average Velocity for Velocity Based Training
- Peak Force for Rate of Force Development
- Eccentric Average Velocity for different training goals
- Recovery time for endurance training
- Rest time between reps or sets
- Percent value of the best repetition on each rep



LENGTH	12"
WIDTH	4"
BLUETOOTH COMPATIBLE	YES
COMPUTER COMPATIBLE	YES

ACCESSORIES



MAGNETIC READER



TENDO RFID SET



TENDO RFID WRISTBAND



TENDO SPRINT SYSTEM



TENDO EXTERNAL LCD STOPWATCH



TENDO BLUETOOTH SET

GYM AWARE

Get the metrics you need to increase performance (height, distance, dip, concentric time, rep rate, mean force, mean power, mean velocity, mean watt/ kg, peak force, peak power, peak velocity, peak watt). Requires no external software. Easy set-up, when the power-tool connects, the application loads up and you are ready to go.

The automatic rep detection works on standard lifts, jumps, Olympic lifts and power cleans thanks to the advanced rep detection and angle of lift measurements. You can also set a threshold for any parameter for visual and audio feedback to motivate athletes while training.

SPECIFICATIONS

LENGTH	9"
WIDTH	6"
WEIGHT	11 LBS
WIFI	Yes
BLUETOOTH	Yes



ISOMETRIC AND FORCE PLATE TESTING

We offer three distinct isometric training & testing solutions that integrate with your force plate of choice. The setup below is available in a bolt to the floor option or stand alone with foot plate. We also offer two rack attached options, (right) including a bolt-on sawtooth attachment for micro adjustments of a barbell and a bolt-on hydraulic attachment for extremely precise micro adjustments.

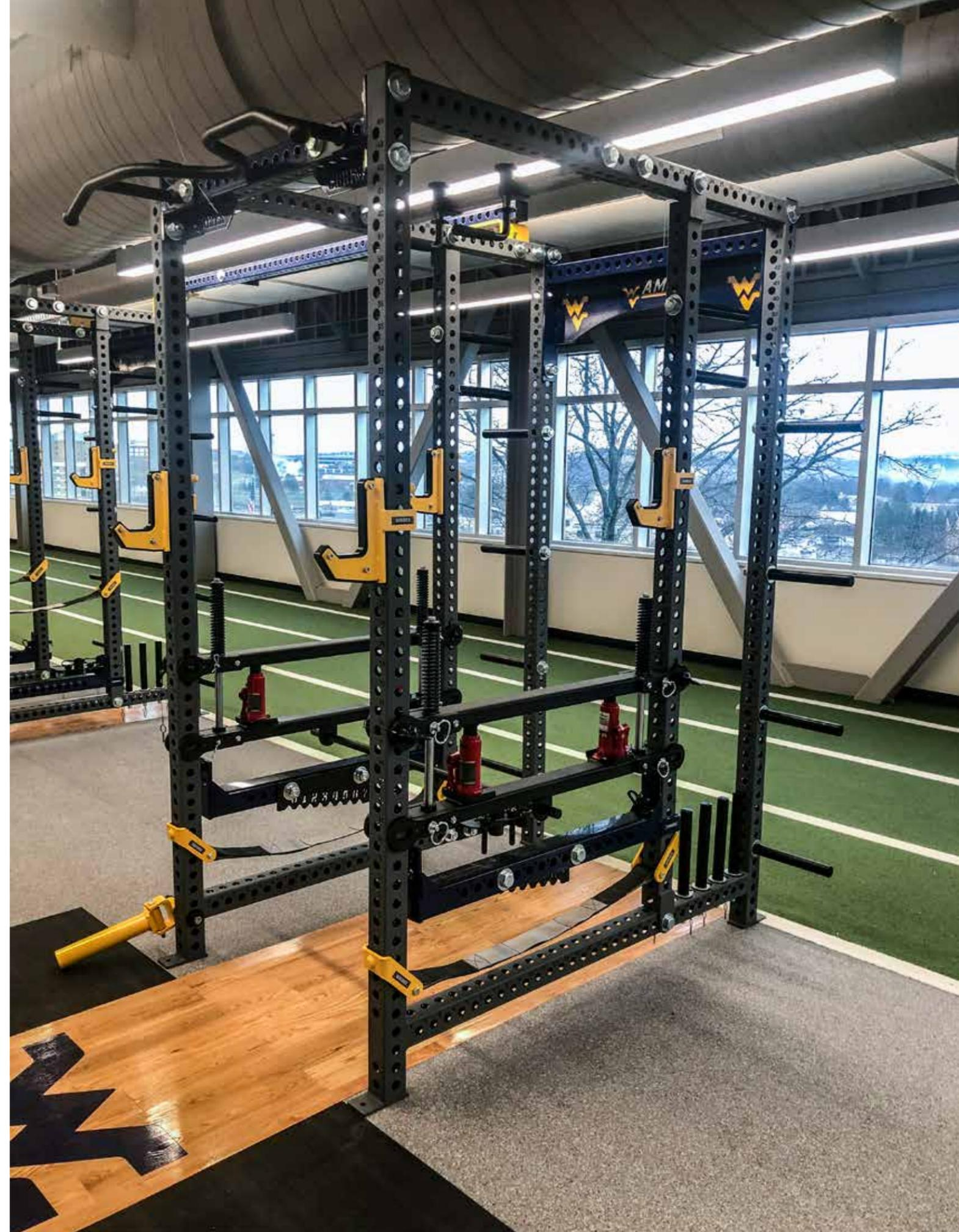



FURNITURE

INTERLOCKING SINGLE DESK

LENGTH	49.25"
WIDTH	27.25"
HEIGHT	46.5"

The Interlocking Single Desk is a rolling desk with capabilities of turning into a larger rolling desk by interlocking with each other. The 4-way hole design for attachments and accessories allows you to maximize your space. Adjustable height, custom sizes, and branded logos and colors allow you to design your desk exactly how you want it.



INTERLOCK DESKS TO FORM LARGER CONFERENCE TABLE



INTEGRATED STORAGE TRAYS



HEAVY DUTY CASTERS



BRANDED LOGOS AND COLORS



LENGTH	84"
WIDTH	84"
HEIGHT	31"
DEPTH	36"

LOW DESK

The Sorinex Low Desk allows for ultimate office versatility in your home or workplace. Originally designed in 2015 for use inside our manufacturing and office spaces at Sorinex HQ. The "L Design" offers traditional seated versatility while accepting most of our Sorinex rack attachments. Attach storage hooks, pins, or Trigger Rollers right to your desk.



HAND-CRAFTED WOOD TABLE TOP



4-WAY HOLE SYSTEM



LENGTH	73"
WIDTH	30"
HEIGHT	96"

STANDING DESK

The Sorinex Standing Desk allows for ultimate office versatility in your home or workplace. Originally designed in 2015 for use inside our manufacturing and office spaces at Sorinex HQ. Attach storage hooks, pins, Jammer Arms or a JxSquat™ right to your desk. Custom sizes, branded logos, colors, and name plates optional.



INTEGRATED STORAGE TRAYS



STEEL BACK PANEL WITH DUAL MONITOR ATTACHMENTS



U.S. ARMY ACFT KIT

Sorinex and the Military are no strangers to each other. Supporting the ones who support our country is always a top priority. We understand and respect the sacrifice these men and women give and are proud to have so many veterans in our circle, in our Bosco Brotherhood. For over two decades Sorinex has been providing the U.S. Military, Federal Agencies, and First Responders with world class equipment to meet their training requirements. We are honored that the men and women who serve our country put their trust in us, and we are honored to be an official supplier of the U.S Army ACFT kits.

ACFT KIT SHIPPING CONTAINER



LENGTH	96.88"
WIDTH	41.01"
HEIGHT	19.25"
WEIGHT	80 LB
MATERIAL	HIGH MOLECULAR WEIGHT, HIGH DENSITY POLYETHYLENE

The Sorinex ACFT Kit Shipping Container is a custom molded container specifically built for the U.S. Army. Made out of High Molecular Weight, High Density Polyethylene (HMW-HDPE) to support the weight of the contents inside and to protect from damages during transport. The shipping containers are easy to forklift and made to be nestable / stackable up to 3 containers high.

ALL COMPONENTS MADE IN THE USA



SPECIALTY BAR SPRING COLLARS

SPRING TYPE	TORSION
INSIDE DIAMETER	2"
MATERIAL	STAINLESS STEEL



92" STRAP

LENGTH	92"
WIDTH	1"
WEIGHT	1 LB
MATERIAL	DURABLE WEBBING



D-BALL

DIAMETER	12"
WEIGHT	10 LB
MATERIAL	3/8" NOMINAL THICK PVC SHELL



DIAMOND BAR

LENGTH	86.625"
WIDTH	27.625"
SLEEVE LENGTH	16"
WEIGHT	60 LB



SPUD INC. SLED

LENGTH	23"
WIDTH	20"
WEIGHT	3.8 LB
MATERIAL	NYLON

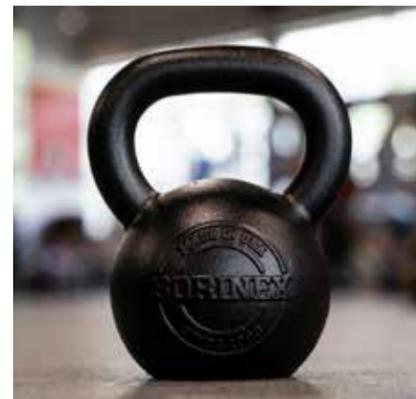

40 LB KETTLEBELLS

WEIGHT	40 LB
MATERIAL	CAST IRON



RECON® LITE BUMPERS

WEIGHT	DIAMETER	THICKNESS
10 LB	450 mm	1.375"
15 LB	450 mm	1.875"
25 LB	450 mm	2.25"
35 LB	450 mm	3.125"
45 LB	450 mm	3.75"



TAPE MEASURE

LENGTH	9"
WIDTH	6.3"
HEIGHT	0.8"
TAPE LENGTH	100' / 30M
REEL	OPEN



STANDARD COLORS & UPHOLSTERY

Standard gloss and texture color options are included in our services. Custom colors are made on demand for an additional cost.



STANDARD RACK COLORS

All standard rack colors shown below are available in gloss or textured options, excluding Military Desert Tan and Military Forest Green. Clear Grind and Clear Coat upgrades available.

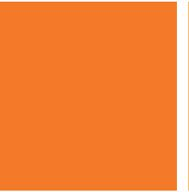
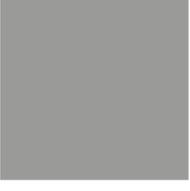
						
Wine Red RAL #3005 Pantone 7638	Ruby Red RAL #3003 Pantone 202 C	Patriot Red Pantone 200 C	Pure Orange RAL #2004 Pantone 1665 C	Signal Orange RAL #2010 Pantone 167 C	Pastel Orange RAL #2003 Pantone 2025 C	Mellow Yellow RAL #1028 Pantone 1375 C
						
Signal Yellow RAL #1003 Pantone 124 C	Traffic Yellow RAL #1023 Pantone 7406 C	Zinc Yellow RAL #1018 Pantone 7404 C	Sun Gold Pantone 871 C	Yellow Green RAL #6018 Pantone 362 C	Mint Green RAL #6029 Pantone 3500 C	Moss Green RAL #6005 Pantone 3435 C
						
Steel Blue RAL #5011 Pantone 2767 C	Postal Blue Pantone 295 C	Gentian Blue RAL #5010 Pantone 7693 C	Light Blue RAL #5012 Pantone 2171 C	Pastel Blue RAL #5024 Pantone 645 C	Viking Purple Pantone Medium Purple C	Basalt Grey RAL #7012 Pantone Cool Gray 10 C
						
Graphite Grey RAL #7024 Pantone 2540 C	Window Grey RAL #7040 Pantone Cool Gray 5 C	Silver Metallic Pantone Cool Gray 8 C	White Texture / White Gloss	Black Texture / Medium Black Gloss	Military Desert Tan 32348 Matte	Military Forest Green 34079 Matte

STANDARD UPHOLSTERY COLORS

All standard upholstery colors shown below are in genuine naugahyde leather.



Adobe White US 394 Ivory US 500 Coral Sand US 502 Froth US 501 Surf US 513 Fjord Blue US 517 Bristol Blue US 515 Pink US 503



Alabaster US 396 Parchment US 385 Shell US 402 Sand US 384 Dusty Jade US 417 Turquoise US 419 Dutch Blue US 518 Mauve US 415



Taupe US 410 Bone US 404 Peach US 406 Vicuna US 401 Northwoods US 528 Grotto US 426 Wedgewood US 414 Tea Rose US 416



Putty US 403 Bisque US 409 Rose US 412 Doe US 519 Lilac US 508 Sage US 526 Space Blue US 353 Rouge Red US 505



Gray Moss US 525 Dewberry US 424 Sunset US 521 Camel US 387 Crocus US 433 Artichoke US 527 Royal US 354 Raspberry US 362



Dove US 413 Woodrose US 423 Paprika US 370 Oak US 421 Deep Violet US 511 Olive Green US 529 Regimental Blue US 345 Dark Cherry US 507



Greystone US 425 Chestnut US 375 British Tan US 365 Terra Cotta US 376 Grape US 509 Alpine US 530 Imperial Blue US 432 American Beauty US 360



Gunmetal US 392 Bronze US 523 Gingersnap US 369 Cinnamon US 377 Sangria US 506 Forest US 344 Sky Blue US 516 Tomato US 358

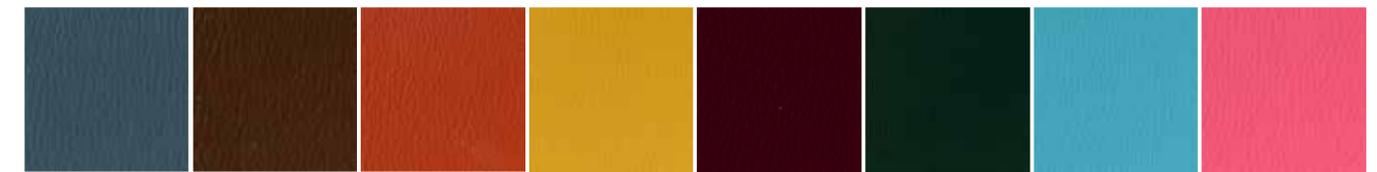

Blue Ridge US 427 Mocha US 381 Cinnabar US 520 Golden Rod US 324 Plum US 361 Yew Green US 350 Capri Blue US 514 Rosalee US 504



Graphite US 429 Rustic Brown US 522 Claret US 357 Golden Corn US 524 Dark Purple US 512 Emerald US 343 China Green US 434 Mandarin Orange US 372



Black US 393 Espresso US 383 Burgundy US 364 Sun Yellow US 322 Concord US 510

BRANDED SOLUTIONS



- A -
Strenuous
B Life B
For Me
- BOSCO BROTHERHOOD -

APPAREL

GRAB ALL YOUR GEAR AT [SORINEX.COM](https://sorinex.com)

SOLUTIONS SPECIALISTS



CLAY ALLEN
NORTHWEST
clay@sorinex.com

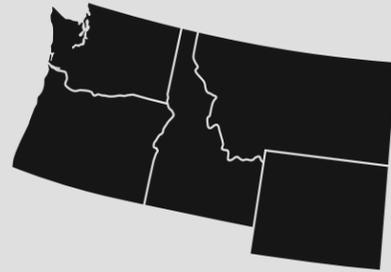

PHIL PROVENCE
WEST COAST
phil@sorinex.com



JEREMY EBERT
SOUTHEAST
jebert@sorinex.com



MATT THOMAS
NORTHEAST
mthomas@sorinex.com



DAN MCKIM
MIDWEST
dmckim@sorinex.com



ALEX WILLIAMS
MIDWEST
alex@sorinex.com



JARED MYATT
GULF COAST
jared@sorinex.com

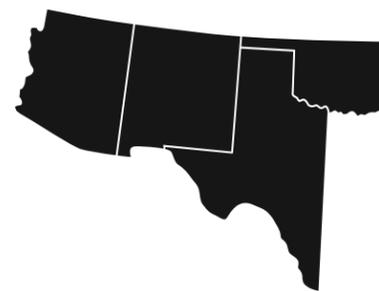

TREY ZEPEDA
SOUTHWEST
trey@sorinex.com



SORINEX[®]
EXERCISE EQUIPMENT

BE LEGENDARY[®]

SORINEX EXERCISE EQUIPMENT, INC.

SORINEX.COM

INFO@SORINEX.COM

1-877-SORINEX

193 LITTON DRIVE

LEXINGTON, SC 29073