



FINISH

Brushed Stainless

MATERIAL

316L Stainless Steel

BOWL SIZE

17 1/2 in x 32 1/2 in

DRAIN SIZE

3 1/2 in

MINIMUM CABINET SIZE REQUIRED

36 in

TOP VIEW*

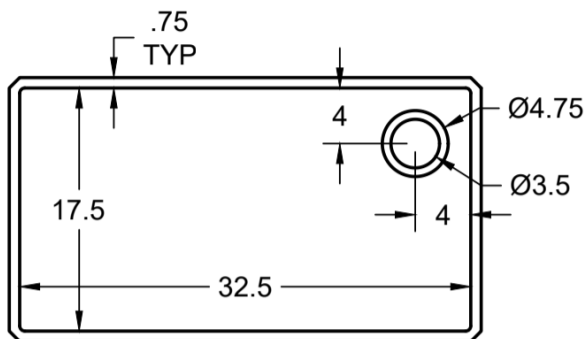

FRONT VIEW*

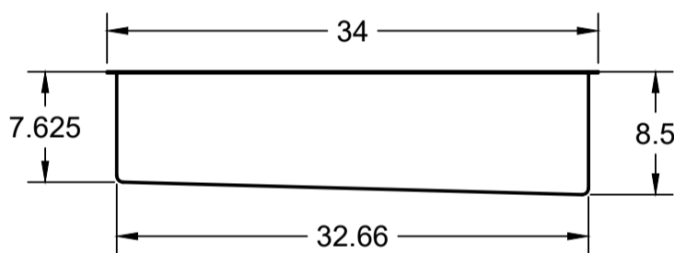

SIDE VIEW*

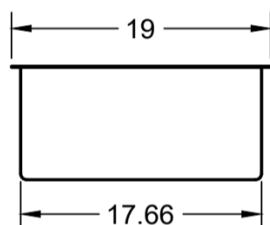

FEATURES

- Consistent 14-Gauge Thickness
- Offset Corner Drain
- Sloped Basin Floor
- R10 Radius Corners
- 3-millimeter thick foam insulation

INSTALLATION METHOD

Undermount installation. Please use installation guide included with product.

WARRANTY

Morgan Tap and Basin Stainless Steel Basin Limited Lifetime Warranty

CODES AND STANDARDS

ASME A112.19.3

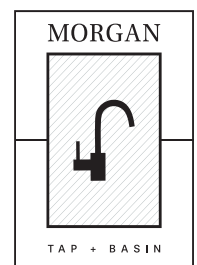

Please visit www.morgantapandbasin.com for product and warranty details. Morgan Tap and Basin reserves the right to make revisions to product specifications without notice.

*All dimensions are measured in inches.