



**Installation Instructions**  
**2HX23152 3RX23152 RX223152**  
**2015-2018 Chevy GMC 2500 3500**  
**Rear Bumper Replacement**

**We know you don't want to read this,  
but you probably should.**

**Read all instructions thoroughly before beginning installation.**





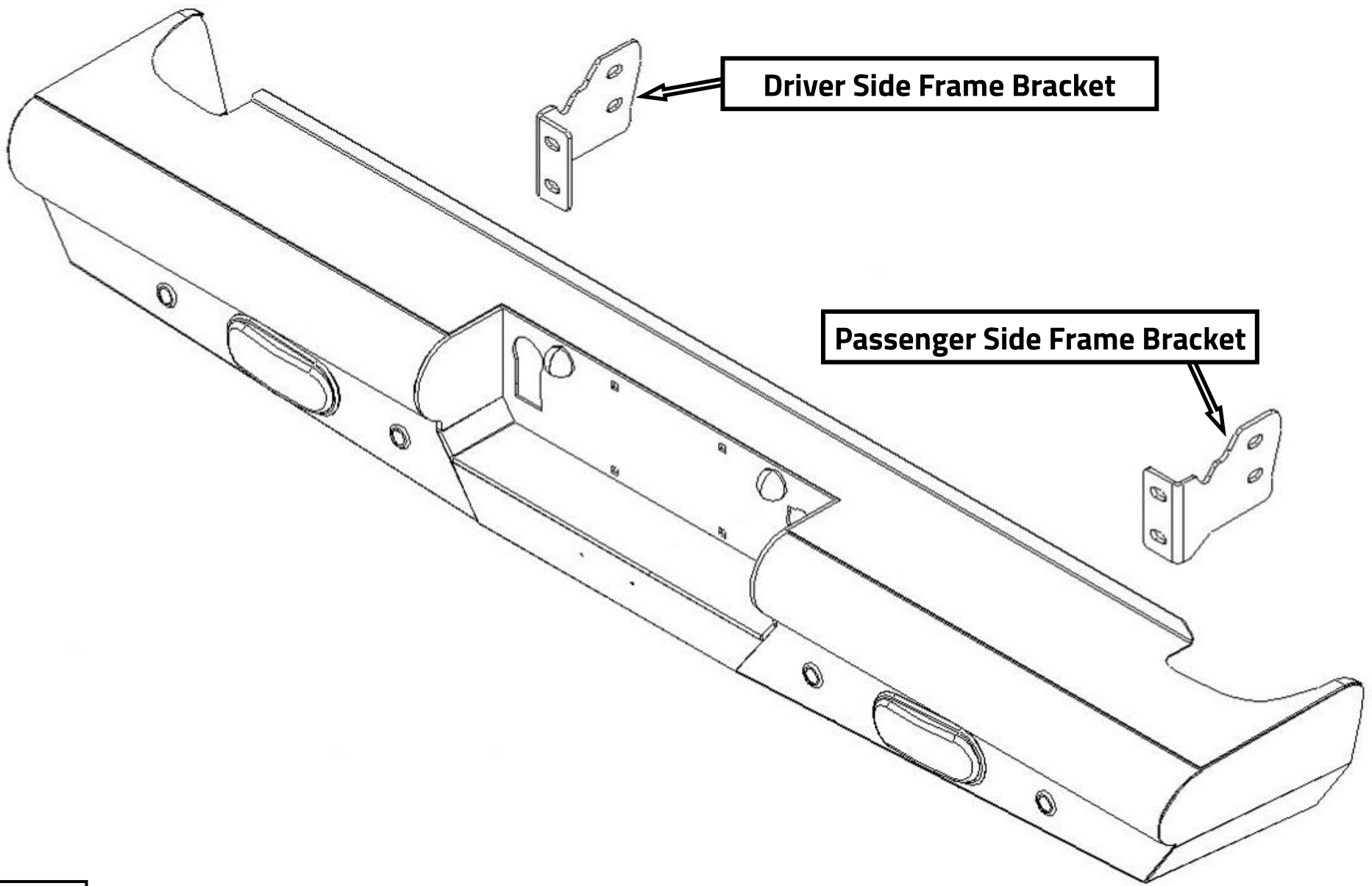

**Step**

1. Disconnect the wire harness plugs from the license plate lights and trailer plug.
2. If your truck has rear sensors, remove them from the factory rear bumper. **DO NOT UNPLUG sensors from wire harness.** Be sure to note the order of the rear sensors. If they are put back in the wrong order, they may not work correctly.
3. Remove the bolts holding factory bumper to the frame. Be sure to remove the bolts from bottom of the frame, by going through bottom of the receiver hitch.
4. Remove the factory bumper.
5. Using hardware provided, install the new rear bumper frame brackets to the frame by placing each bracket inside the frame channel and bolting to the outside frame wall.
6. Adjust the new bumper to match the lines of the truck.
7. Tighten all bolts to 70 lbs. of torque.
8. Install the sensors into the holes provided using the included grommets. We recommend using a clear silicone caulk to secure the sensors in place. If your truck does not have sensors, use the plugs and grommets provided.
9. Enjoy your new bumper! Send us pictures of your truck with our equipment and it could end up on the website! Email your pictures to: [Service@AmericanBuiltEQ.com](mailto:Service@AmericanBuiltEQ.com).

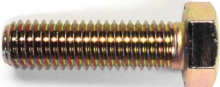

**Hardware Provided:**

- |   |  |   |
|---|--|---|
|  <b>x 4</b> |  <b>x 8</b> |  <b>x 16</b>        |
| Sensor Grommet  | 1/2" x 1 3/4" Hex Bolt   | 1/2" Washer   |
|  <b>x 4</b> |  <b>x 8</b>                        |  <b>x 8</b> |
| Plug  | 1/2" Hex Nut   | 1/2" Lock Washer  |