

# USER MANUAL

## PORTABLE AIR CONDITIONER

**Model:**

Greenland GLP07AC

Before using TURBRO Portable Air Conditioner, please read this manual carefully and retain it for future reference.

Customer Service: [support@turbro.com](mailto:support@turbro.com)  
[www.turbro.com](http://www.turbro.com)

# TURBRO

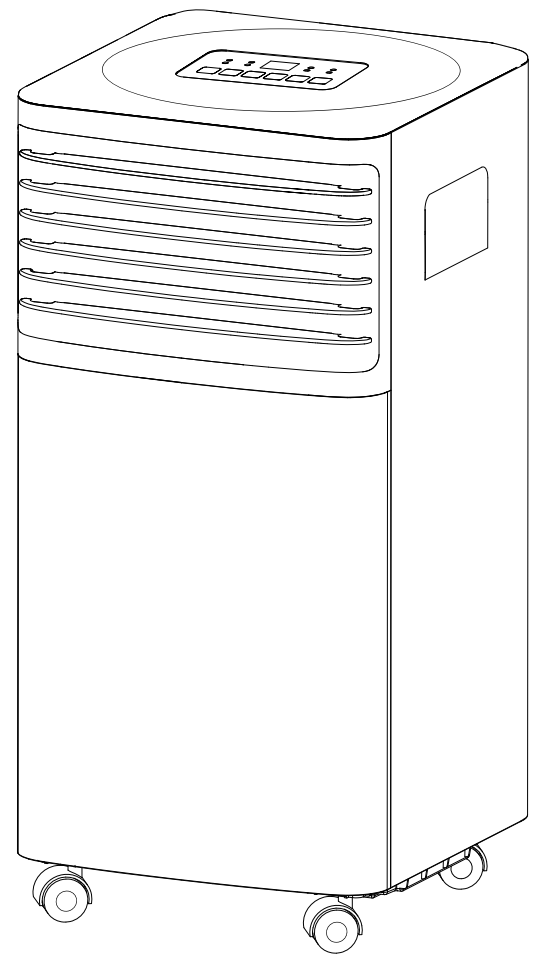

## Tips for First-Time Use

1. Allow the unit to sit upright for at least 3-4 hours before powering on. Shipping carriers may set the unit on its side, which causes the refrigerant to pool in certain areas. Standing the unit upright for 3-4 hours allows the refrigerant to move freely within the coils.
2. Some parts with sharp edges may cause injury, so gloves are highly recommended for unpacking and installing.
3. Run the unit continuously for 24 hours after letting the unit stand upright for 3-4 hours. This will give even the smallest and technically unavoidable air bubbles in the coolant circuit that may have been created during transport from our factory to your doorstep the opportunity to migrate to the top of the cooling circuit.
4. If you have any difficulties during installation, please contact Customer Support Team via [support@turbro.com](mailto:support@turbro.com) for help.
5. If you have any problems with your product, please send us an email before submitting a return request, as there might be a simple solution for your issue.

# CONTENTS

<b>SAFETY INFORMATION</b>	<b>01</b>
<b>PARTS DESCRIPTION</b>	<b>03</b>
<b>INSTALLATION INSTRUCTIONS</b>	<b>04</b>
Installation Location	04
Tool Suggested	05
Installing in Double-Hung Sash / Sliding Casement Windows	05
Installing Exhaust Hose	07
<b>OPERATING INSTRUCTIONS</b>	<b>08</b>
Control Panel	08
Operating from the Control Panel	08
Operating from the Remote Control	10
Controlling the device with the remote control	11
Water Drainage Methods	12
Tips for Correct Use	13
<b>CLEANING</b>	<b>14</b>
Cleaning the Outer Case	14
Cleaning the Air Filters	14
Maintenance Checklists	15
<b>TROUBLESHOOTING</b>	<b>15</b>
Self-Diagnosis	15
<b>WARRANTY &amp; CUSTOMER SUPPORT</b>	<b>17</b>
Warranty	17
Customer Support	18

# SAFETY INFORMATION

Please read all instructions before use and save this user manual for future reference. A digital version can be obtained from Customer Support.

Your safety and the safety of others are very important to us. We have provided many important safety messages throughout this manual and on the appliance itself. Always read and follow all posted safety messages.

To reduce the risk of fire, electric shock, injury, or death to persons using or near this appliance, please follow some basic safety precautions. These precautions include, but are not limited to, the following:

## Installation and Setup

- This appliance is not intended for use by any persons (including children) with reduced or restricted physical, mental, or sensory capabilities, or lack of experience and knowledge, unless under the direct supervision of a person responsible for their safety.
- Please keep plastic bags and sheets out of the reach of children as they might be mistakenly used for play. Packaging materials can become airtight chambers and may pose a risk of suffocation if not disposed of properly.
- When installing or moving the appliance, be careful not to pinch, crush, or damage the power cord.
- Install the appliance on a sturdy, level floor capable of supporting up to 110lbs(50kg). Installation on a weak or un-level floor can result in the risk of property damage and personal injury.
- Never attempt to operate this appliance if it visibly damaged, malfunctioning, disassembled or has missing or broken parts. This includes exposed wiring on a damaged cord or electrical plugin. All repairs and servicing must be performed by qualified service personnel. Use only authorized TURBRO factory OEM parts.
- Do not use heating equipment near the appliance.
- In the event of a gas leak (propane gas, LP gas, etc.) do not operate this or any other appliance. Open a window or door to ventilate the area immediately.
- Only use the appliance in an upright position. Make sure the angle of inclination  $<10^{\circ}$ . Always place the appliance on a stable, flat, level surface to prevent the air conditioner from overturning.

## Electrical Safety Warning

 **WARNING**

### Electrical Connections

Before plugging the appliance into the mains socket, check that:

- The mains power supply corresponds to the value indicated on the rating plate on the back of the appliance.
- The power socket and electrical circuit are adequate for the appliance, and have appropriate fuse protection in the fuse box of the building.

- The mains socket matches the plug. If this is not the case, have the plug replaced.
- The mains socket is adequately earthed. Failure to follow these important safety instructions absolves the manufacturer of all liability.

Important information for correct disposal of the product in accordance with EC Directive

**2012/19/EU.**



At the end of its working life, the product must not be disposed of as urban waste. It must be taken to a special local authority differentiated waste collection center or to a dealer providing this service. Disposing of a household appliance separately avoids possible negative consequences for the environment and health deriving from inappropriate disposal and enables the constituent materials to be recovered to obtain significant savings in energy and resources. As a reminder of the need to dispose of household appliances separately, the product is marked with a crossed-out wheeled dustbin.

- Always use the switch on the control panel or remote control to turn the unit off, and do not start or stop operation by plugging in or unplugging the power cord. It can result in the risk of electric shock.
- Do not touch the buttons on the control panel with your wet and damp fingers.
- Do not use the unit in the presence of inflammable substance or vapour such as alcohol, insecticides, gasoline, etc.
- If the appliance is making unusual sounds or is emitting smoke or an unusual odor, unplug it immediately.
- Always grasp the plug when plugging in or unplugging the appliance. Never unplug by pulling on the cord. It can result in the risk of electrical shock and damage.

**According to the EN standard**

- This appliance can be used by children aged from 8 years and above and persons with reduced physical, sensory or mental capabilities or lack of experience and knowledge if they have been given supervision or instruction concerning use of the appliance in a safe way and understand the hazards involved.
- Children shall not play with the appliance. Cleaning and user maintenance shall not be made by children without supervision.
- If the supply cord is damaged, it must be replaced by the manufacturer, its service agent or a similarly qualified person in order to avoid a hazard.
- The appliance shall be installed in accordance with national wiring regulations.
- When the fuse is blown/circuit breaker is tripped, check the house fuse/circuit breaker box and replace fuse or reset breaker.
- Details of type and rating of fuses : T; 3.15A; 250VAC.

**According to the IEC standard**

- This appliance is not intended for use by persons (including children) with reduced physical, sensory or mental capabilities, or lack of experience and knowledge, unless they have been given supervision or instruction concerning use of the appliance by a person responsible for their safety.
- Children should be supervised to ensure that they do not play with the appliance.
- If the supply cord is damaged, it must be replaced by the manufacturer, its service agent or similarly qualified persons in order to avoid a hazard.
- The appliance shall be installed in accordance with national wiring regulations.

### IMPORTANT - Grounding Method

- This product is equipped with a power supply cord that has a three-pronged grounded plug. It must be plugged into a mating grounding type receptacle in accordance with the National Electrical Code and applicable local codes and ordinances.
- If the circuit does not have a grounding type receptacle, it is the responsibility and obligation of the customer to exchange the existing receptacle in accordance with the National Electrical Code and applicable local codes and ordinances.
- The third ground prong should not, under any circumstances, be cut or removed. Never use the cord, the plug or the appliance when they show any sign of damage.
- Do not use your appliance with an extension cord unless it has been checked and tested by a qualified electrical supplier.
- Improper connection of the grounding plug can result in risk of fire, electric shock and/or injury to persons associated with the appliance.
- Check with a qualified service representative if in doubt that the appliance is properly grounded.

## PARTS DESCRIPTION

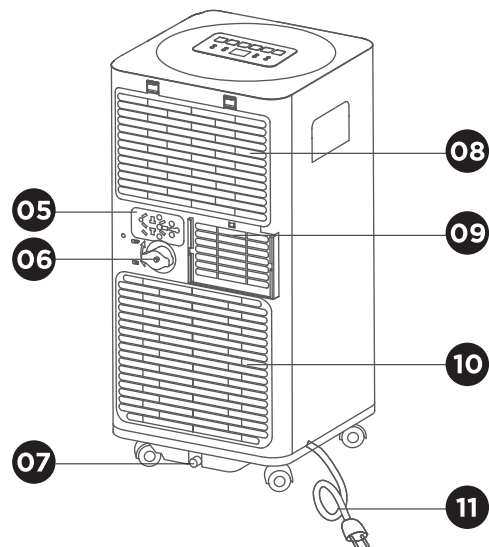
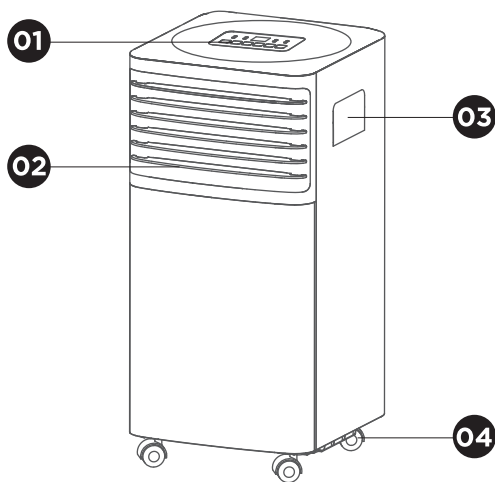

**01** Control Panel

**02** Horizontal Airflow Louver

**03** Handle(both sides)

**04** Casters

**05** Plug Storage Socket

**06** Middle Condenser Drain





**07** Condenser Drain

**08** Air Intake Grille

**09** Air Outlet Grille

**10** Air Intake grille

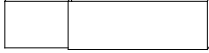
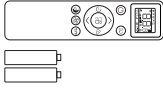
**11** Power Cord

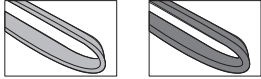
PARTS	PARTS NAME	QUANTITY
	Hose Inlet Exhaust Hose Hose Outlet	1 set
	Window Panel + Adjustment Panel Metal Locking Screw	1 set
	Extension Panel without Hole	1 pcs
	Remote Control Battery	1 set
	Drainage Hose	1 pcs
	Foam Seal (self-adhesive)	1 set

## INSTALLATION INSTRUCTIONS

### Installation Location

- The air conditioner should be placed on a firm floor to minimize noise and vibration. For safe and secure positioning, place the unit on a smooth, level floor strong enough to support the unit.
- The unit must be installed near a properly rated grounded socket.
- Allow at least 19.7 inches / 50 cm of space away from the wall with the window for efficient working.
- Never place any obstacles around the air inlet or outlet of the unit.
- The hose can be compressed or extended moderately, but it is desirable to keep the length to a minimum. Also make sure the hose does not have any sharp bends or sags.

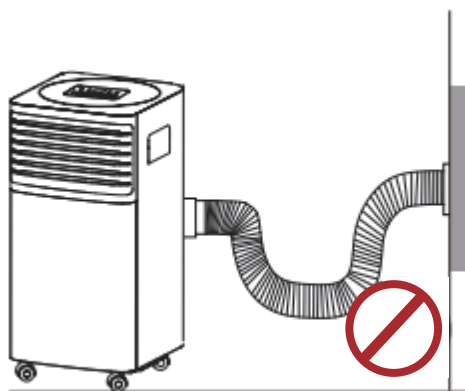

**NOT RECOMMENDED**

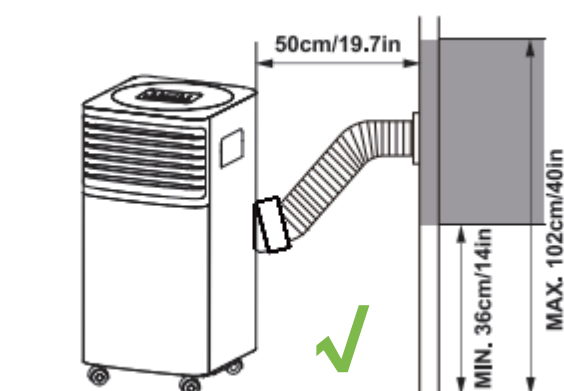

**RECOMMENDED**

## Tool Suggested

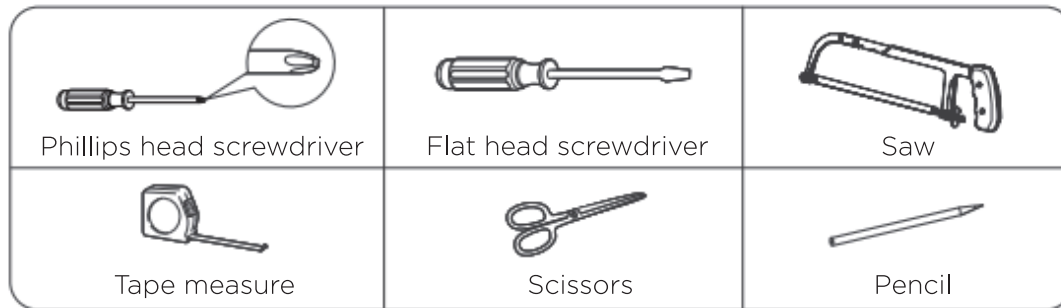

The window panel kit has been designed to fit most standard windows that open vertically or horizontally; however, it may be necessary for you to improvise/modify some aspect of the installation procedures for certain types of window.

The included window panels don't fit for tilting or casement windows. You need to purchase a window seal pack (it's not included). Please contact TURBRO Service team (support@turbro.com), if you need any help with the installation.

Minimum and maximum window openings: 9 - 59 Inches

### NOTE:

If the width of your window is smaller than 20.5 inches, please remove the adjusting panel from the window panel and then cut the window panel to make the width of the window panel the same width as your window.

## Installing in Double-Hung Sash / Sliding Casement Windows

### A. Required Parts:

- Foam Seal
- Window Panel with Hole
- Adjustment Panel without Hole
- Extension Panel
- Metal Locking Screw

### B. Assembly:

a. Cut the foam seal to the proper length and attach it to the window sash.

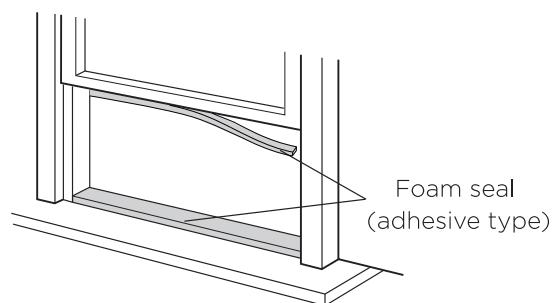

b. Slide Adjustment Panel **02** into the Window Panel with Hole **01** and Extension Panel **03**.

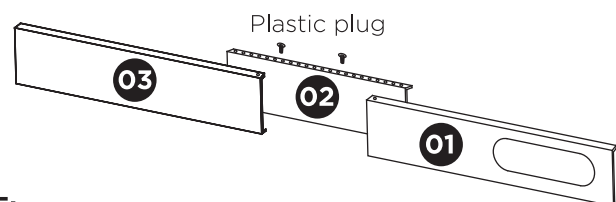

### NOTE:

A plastic locking pin is holding the window panel kit together during shipment. Prior to installation, remove the plastic locking pins.



- c. Place the assembled window panels on the window sash and adjust until it fully covers the width of your window.

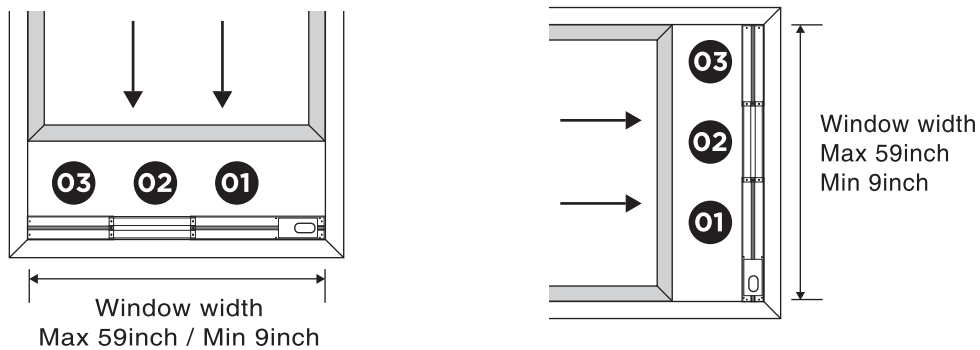

**NOTE:** If the width of your window is smaller than 20.5 inches, please remove the adjusting panel from the window panel and then cut the window panel to make the width of the window panel the same width as your window.

- d. Use the provided metal locking screws to secure the window panel kit.

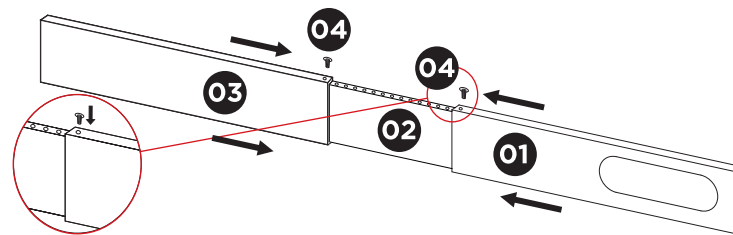

- e. Close the window securely against the assembled window panel kit.

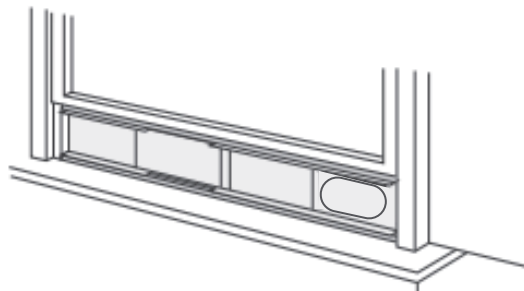

- f. Cut the foam seal to an appropriate length and seal the open gap between the top window sash and outer window sash.

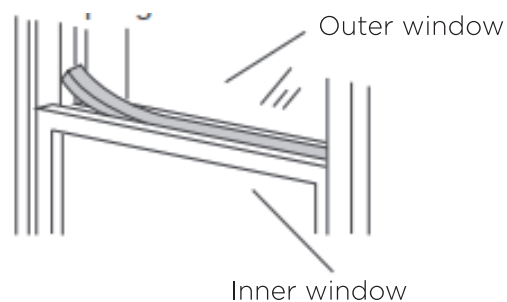

## Installing Exhaust Hose

**COOL & DEHUMIDIFY MODE:** Air exhaust hose should be connected to the portable air conditioner.

**FAN MODE:** Air exhaust hose should be disconnected from the portable air conditioner.

### A. Required Parts:

- Hose Inlet
- Exhaust Hose
- Hose Outlet

### B. Assembly:

- a. Align both the arrows of the Hose Inlet connector and the Exhaust Hose, then rotate the Hose Inlet clockwise or counter-clockwise to lock into place. (see Fig. 1)
- b. Use the same way to attach the Hose Outlet and the Exhaust Hose.
- c. Fig.2 is the assembled exhaust hose.

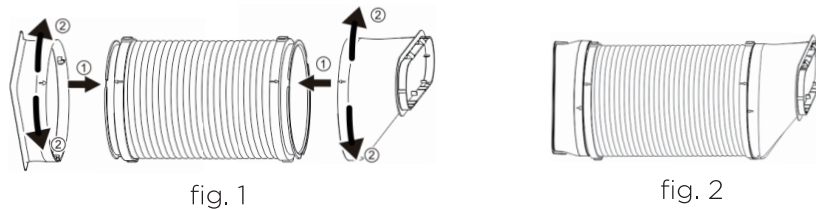

- d. Install the Hose Inlet into the groove at the back of the unit and extend the exhaust hose. (see Fig.3)

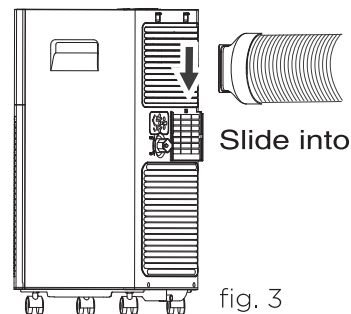

- e. Affix the Hose Outlet to the window panel. (see Fig.4)

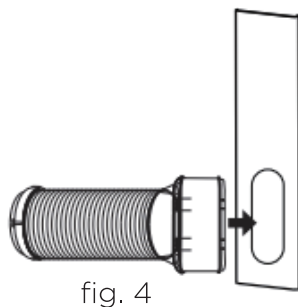

**NOTE:** The exhaust hose can be compressed or extended moderately, but it is desirable to keep the length to a minimum. Also make sure that the hose does not have any sharp bends.

# OPERATING INSTRUCTIONS

## Control Panel

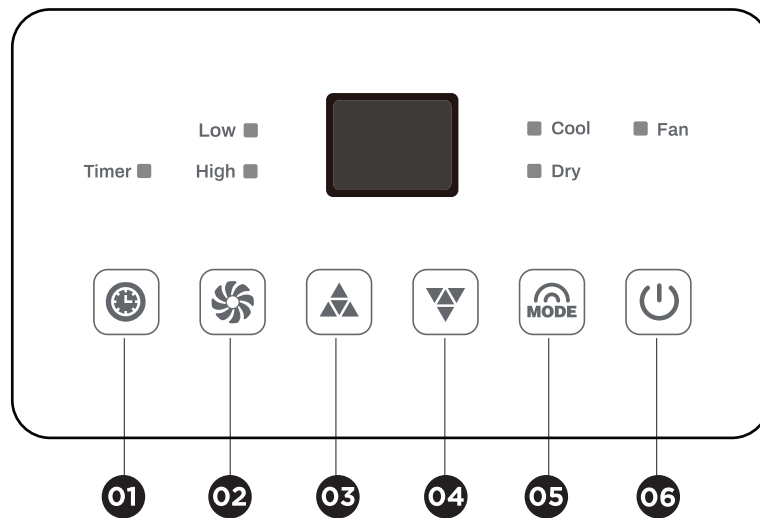

**01** Timer Button

**02** Fan Speed Button

**03** Increase Button

**04** Decrease Button

**05** Mode Button

**06** ON/OFF Button

## Operating from the Control Panel

The Control Panel enables you to manage all the main functions of the appliance, but to fully exploit its potential, you must use the remote control.

### TURNING THE APPLIANCE ON

- Plug into the mains socket, then the appliance is in standby.
- Press the ON/OFF Button (⏻) then the display screen will light up.

**NOTE:** Never turn the air conditioner off by unplugging from the mains. Always press the ON/OFF Button (⏻), then wait for a few minutes before unplugging. This allows the appliance to perform a cycle of checks to verify operation.





### Operating mode selection

Pressing Mode Button (MODE) will cycle through the following modes, as shown below:



## COOL MODE

Ideal for hot muggy weather when you need to cooling and dehumidify the room.



- Press the Mode Button  until the 'Cool' indicator lights up. Also, the screen will appear .
- Press the  or  button to select your desired temperature 18°C -32°C (64°F -90°F).
- Press the Fan Button  to select the fan speed. The indicator light shows the selected speed.

High	To reach the desired temperature as rapidly as possible.
Low	To operate under low noise.

## DRY MODE

Ideal to reduce room humidity (spring and autumn, rainy periods or in damp rooms, etc).



**NOTE:** Before using the dry mode, please make sure the air exhaust hose attached to the appliance to allow the moisture to be discharged externally and the drain hose attached to avoid any leaking. (The Water Drainage Methods will be mentioned in the following parts)

- Press the Mode Button  until the 'Dry' indicator lights up. Also, the screen will appear .
- In this mode, the unit will run at the low speed and the fan speed cannot be adjusted.

## FAN MODE

When using this mode, the unit doesn't need to be attached with the air exhaust hose.







- Press the Mode Button  until the 'Fan' indicator lights up.
- Press the Fan Button  to select the fan speed.

FAN SPEED	SYMBOL
High	
Low	



## TIMER FUNTION

This timer can be used to delay the unit start up or shutdown, this avoids wasting electricity by optimizing operating periods.

### Programming start up

- Press the ON/OFF Button  to turn on the unit and choose your desired mode, for example 'cooling, 68 °F and high fan speed'. Then press the ON/OFF Button  again to turn off the unit.
- Press the Timer Button , the timer indicator and the screen digital will flash. Use the  and  keys to select the desired switch-on delay (displayed in hours) and wait for about 5 seconds. When the timer is active, the 'Timer' indicator will keep stay on and the screen will display .
- Press the Timer Button  again, the timer will be canceled, and the 'Timer' indicator will disappear.

**Programming shut down**

- With the unit on, please press the Timer Button , the timer indicator and the screen digital will flash. Choose the required delayed shut-down time and wait for about 5 seconds. When the timer is active, the 'Timer' indicator will keep stay on and the screen will display .
- Press the Timer Button  again, the timer will be canceled, and the 'Timer' indicator will disappear.

**TEMPERATURE SCALE CONVERSION**

The device is capable of displaying temperatures in both degrees Celsius as well as degrees Fahrenheit.

With the unit on, press and hold the  and  button together for 3 seconds at the same time, then you can switch the unit of temperature.

For example:

- In Celsius degree, the digital displays like fig1.
- In Fahrenheit degree, the digital displays like fig2.

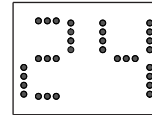

Fig. 1

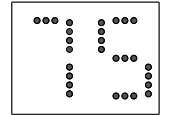
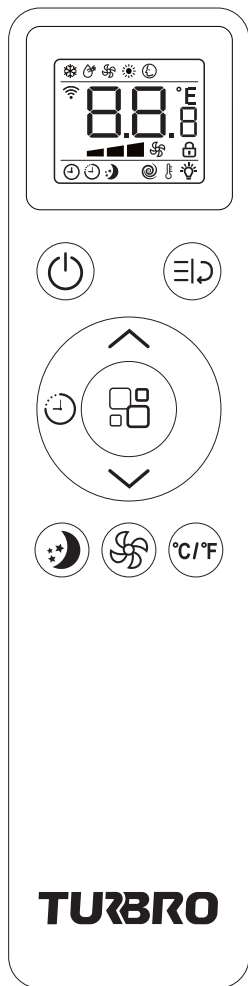









Fig. 2

**Operating from the Remote Control**



	<b>ON/OFF</b>
	<b>Mode</b>
	<b>Increase</b>
	<b>Decrease</b>
	<b>Fan Speed</b>
	<b>Timer</b>
	<b>Temperature Scale Switch</b>
	<b>Function</b>

**NOTE:** This is a universal remote control for a variety of models. If your model does not have a function listed on the remote control, there will be no changes in the operation of your unit.

**Using the remote**

The maximum range of the remote control is 23 feet / 7 meters away from the appliance (without obstacles between the remote control and the receiver).

The remote control must be handled with extreme care. Do not drop it or expose it to direct sunlight or sources of heat. If the remote control do not work, please try to take out the battery, and put it back.



### Inserting or replacing the batteries

- Remove the cover on the rear of the remote control
- Insert two "AAA" 1.5V batteries in the correct position (see instructions inside the battery compartment)

### NOTE:

- If the remote control unit is replaced or disposed of, the batteries must be removed and discarded in accordance with current legislation as they are harmful to the environment.
- Do not mix old and new batteries. Do not mix alkaline, standard (carbon-zinc) or rechargeable (nickel-cadmium) batteries.
- Do not dispose of batteries in fire. Batteries may explode or leak.
- Remove the batteries if the remote control won't be used for a long time.











## Controlling the device with the remote control

The following functions only can be active by using the remote:

Press the Function Button  to activate the following functions:







### TURBO FUNCTION







This function is ideal for cooling the room in the shortest time. When this function is active, the unit will be set to COOL MODE, 18°C ( 64°F ) and high fan speed automatically.

- Press the Function Button  until the Turbo symbol  flashes on the screen.
- Press the Function Button  again to confirm, then the Turbo symbol  will stop flashing and stay on display screen.
- To cancel this function, press the Function Button  , then the Turbo symbol  flashes on the display screen. Press the Function Button  again to confirm, the Turbo symbol  will stop flashing and disappear from screen. This means the Turbo Function is canceled.
- Press other buttons like  or  or  can also cancel this function.

### FOLLOW ME FUNCTION

In this mode, the remote control serves as a remote thermostat allowing for the precise temperature control at its location, rather than around the air conditioner.

- Point the remote control towards the air conditioner and press the Function Button  , and then press  or  button until the Temp Sensing symbol  appears and flashes on the display screen.
- Press the Function Button  again to confirm, then the Temp Sensing symbol  will stop flashing and stay on display screen.

- The actual temperature at its location will be displayed on the screen of the remote. The remote control will send this signal to the air conditioner every 20 minutes interval. If the air conditioner does not receive the Temp Sensing signal during any 25 minutes interval, the unit will exit the Follow Me Mode automatically.
- To cancel this function, press the  button, and then press  or  button until the Temp Sensing symbol  flashes on the display screen. Press the  button again to confirm, the Temp Sensing symbol  will stop flashing and disappear from screen. This means the Follow Me Function is canceled.

## Water Drainage Methods

TURBRO portable air conditioner comes with the auto-evaporation system. The unit can automatically evaporate the condensate. There is no need to empty the water except in humid conditions. When you run the dry mode, then it's required to install the hose as the unit might pull more water from the air.

When the water tank is full with water, the unit stops running and shows **Ft** (FULL TANK as mentioned on SELF-DIAGNOSE ). The compressor and fan won't restart until the water tank has been drained.

There are 2 ways to remove collected water from the air conditioner.

### Method A: Manual Drainage

- Switch off the device and disconnect it from the mains by pulling out the mains plug.
- Place a receptacle pan (does not include) under the lower drain port.
- Remove the cap from the lower drain port and allow the water to flow into the pan. Your pan may not hold the full contents of the water tank. A number of fills of your pan may be required.
- Tilt the unit by lifting it slightly upwards from the front until no more water drains from the outlet.
- After the water is drained, replace the cap on the lower drain firmly.
- Reconnect the power plug to the power outlet and restart the air conditioner by pressing the power switch. Ensure that the unit is in COOL or DRY mode. The compressor will start approximately 3 minutes after the unit is turned on.

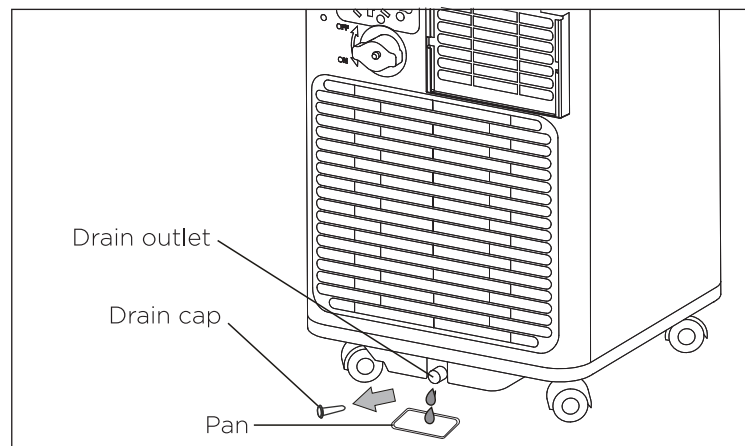

## Method B: Continuous Draining

- Switch off the device and disconnect it from the mains by pulling out the mains plug.
- Remove the drain cap from the lower or middle drain port. During this step, some residual water may spill so place a receptacle pan (does not include) under the drain port to collect the water.
- Insert the 1/2" drain hose into the drain port. The water can be continuously drained through the hose to the floor or a bucket. If you use a bucket, do not forget to empty it regularly.

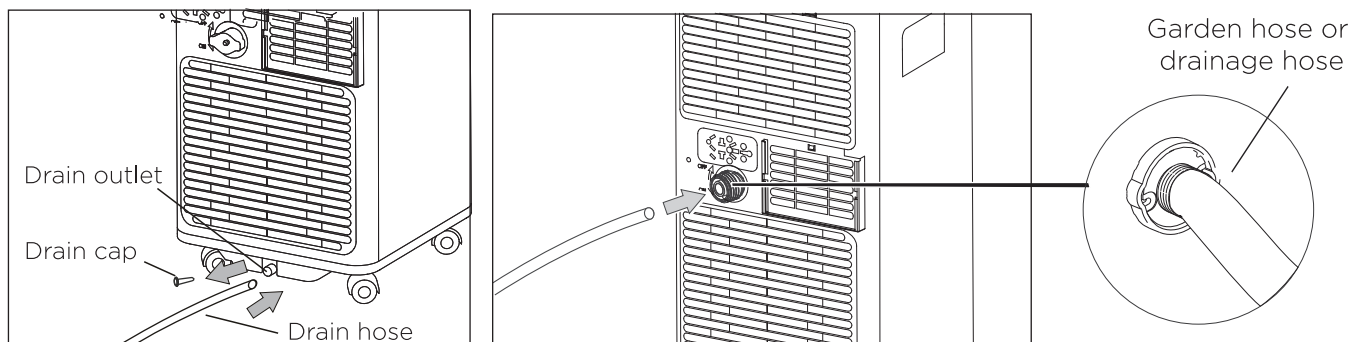

**NOTE:** Please be sure that the height of and section of the drain hose should not be higher than that of the drain outlet, or the water tank may not be drained.

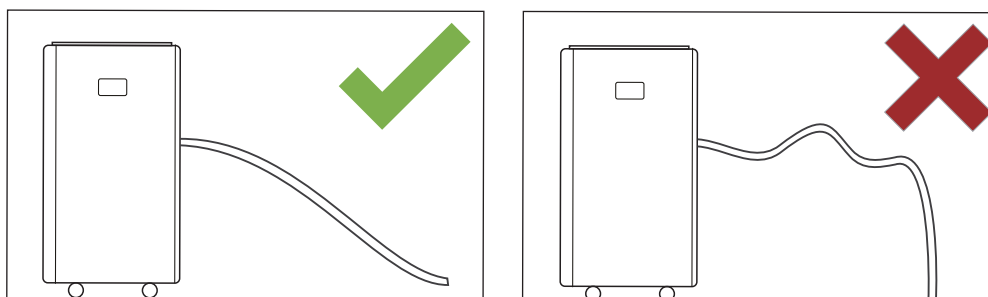

## Tips for Correct Use

Follow these tips to get the best performance of your appliance:

- Close the windows and doors in the room to be cooling. When installing the appliance semi-permanently, you should leave a door slightly open (as little as 0.4 inches / 1 cm) to guarantee correct ventilation.
- Close the windows and doors in the room to be cooling. When Protect the room from direct exposure to the sun by partially closing the curtains and blinds to make the appliance much to run more economically.
- Never rest objects of any kind on the appliance;
- Do not block the air inlet or outlet of the appliance. Reduced air flow will result in poor performance and could damage the unit.
- Make sure there are no heat sources in the room.
- Never use the appliance in very damp rooms (for example laundries).



- Never use the appliance outdoors.
- Make sure the appliance is standing on a level surface. If necessary, place the castor locks under the front wheels.

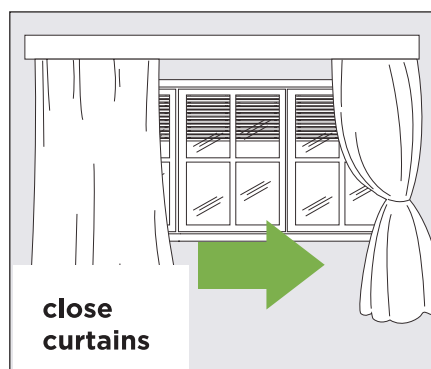
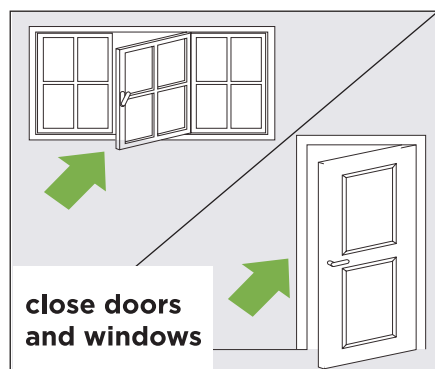

## CLEANING

Before cleaning or maintenance, turn the appliance off and wait for a few minutes, then unplug from the electrical outlet.

### Cleaning the Outer Case

You should clean the appliance with a slightly damp cloth then dry with a dry cloth.

- Never wash the appliance with water. It could be dangerous.
- Never use petrol, alcohol or solvents to clean the appliance.
- Never spray insecticide liquids or similar.

### Cleaning the Air Filters

To keep your appliance working efficiently, you should clean the filter every three months.

A. The filter can be removed as shown in the picture below.

B. Use a vacuum cleaner to remove dust accumulations from the filter.  
If it is very dirty, immerse in warm water and rinse a number of times.  
The water should never be hotter than 40°C (104°F).

C. After the filter has dried completely, replace it back into the air conditioner.

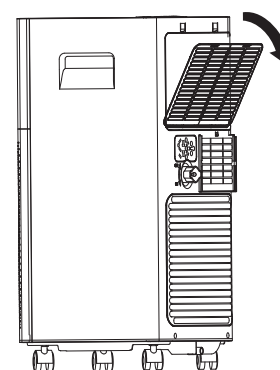

#### NOTE:

- Do not touch the metal fins in the air conditioner after removing the filter, as they may cause personal injury.
- Do not attempt to dry the filter with a hairdryer or other heating elements as this may deform or ignite the filter.
- Do not operate the air conditioner if the air filter is missing.

## Maintenance Checklists

### Pre-Season Maintenance Checklist

- Check the power cord for any cuts or exposed wiring
- Check the ground prong is still on your power plug
- Clean the air filter
- Check whether the hose adapters and exhaust hose are installed tightly and free of damage

### Post-Season Maintenance Checklist

- Disconnect unit from the power outlet
- Clean air filter and exterior case
- Drain any accumulated water from the air conditioner
- Wrap the air conditioner in plastic to prevent the accumulation of dust



### Long-Term Storage Checklist

- Disconnect unit from the power outlet
- Clean air filter and exterior case
- Wrap and/or cover the unit to prevent the accumulation of dust within the unit
- Do not attempt to dry the filter with a hairdryer or other heating elements as this may deform or ignite the filter.
- Do not operate the air conditioner if the air filter is missing

## TROUBLESHOOTING

### Self-Diagnosis

This unit has a self diagnosis system to identify a number of malfunctions. Error messages will be displayed on the display screen.

IF IS DISPLAYED	WHAT SHOULD I DO?
 <p>PF PROBE FAILURE (sensor damaged)</p>	<ul style="list-style-type: none"> <li>● If this is displayed, contact TURBRO service team.</li> </ul>
 <p>Ft FULL TANK (safety tank full)</p>	<ul style="list-style-type: none"> <li>● Empty the internal safety tank, following the instructions in the "WATER DRAINAGE METHODS"</li> </ul>

Troubleshoot your problem by using the chart below. If the air conditioner still does not work properly, please contact TURBRO customer service team via [support@turbro.com](mailto:support@turbro.com). We usually reply to you within 1 business day.

ISSUE	POSSIBLE CAUSE	POSSIBLE REMEDY
Does not start when pressing the ON/OFF button	<ul style="list-style-type: none"> <li>a. Didn't plug into the electrical outlet</li> <li>b. The internal safety device has tripped</li> </ul>	<ul style="list-style-type: none"> <li>a. Plug into the required wall outlet</li> <li>b. Wait for 30 minutes, if the problem can't be solved, contact the TURBRO customer service team</li> </ul>
Unit stops operating	<ul style="list-style-type: none"> <li>a. Room temperature is lower than set temperature (cooling mode)</li> <li>b. FT appears on the display screen</li> <li>c. LT appears on the display screen</li> </ul>	<ul style="list-style-type: none"> <li>a. Reset the temperature</li> <li>b. Drain the water tank (Refer to 'Water Drainage Methods')</li> <li>c. After defrosting is finished, the unit will resume operation</li> </ul>
No air is blowing from the air conditioner	<ul style="list-style-type: none"> <li>a. The air exhaust hose is bent</li> <li>b. Air outlet / inlet is blocked</li> </ul>	<ul style="list-style-type: none"> <li>a. Position the air exhaust hose correctly and avoid any sharp bends or sags</li> <li>b. Check and remove the obstacles blocking the air outlet and inlet</li> </ul>
Not cool enough	<ul style="list-style-type: none"> <li>a. The windows, doors and/or curtains are not closed</li> <li>b. There are heat sources inside the room (oven, hairdryer, etc)</li> <li>c. The air exhaust hose is not connected or blocked</li> <li>d. The temperature is set too high</li> <li>e. Air filter is blocked by dust</li> <li>f. The unit will take about 3 minutes of operation before cooling / heating occurs</li> </ul>	<ul style="list-style-type: none"> <li>a. Make sure all the doors, windows and curtains are closed (Refer to 'Tips for Correct Use')</li> <li>b. Remove the heat sources if possible</li> <li>c. Connect the air exhaust hose and make sure it can function properly (Refer to 'Installing the Air Exhaust Hose')</li> <li>d. Set a lower temperature</li> <li>e. Clean the air filter (Refer to 'Cleaning the Air Filters')</li> <li>f. Wait for 3 minutes until the compressor safety device delayed process has passed</li> </ul>
Noisy or vibration	The unit is placed on a not level or flat floor or surface	Place the unit on a flat, level surface if possible

ISSUE	POSSIBLE CAUSE	POSSIBLE REMEDY
Produces gurgling sound	Has the unit just been turned on or off?	The flowing water sound is the refrigerant inside the air conditioner, which is completely normal
Produces unpleasant smell	Air filter clogged	Clean the air filter (Refer to 'Cleaning the Air Filters')
<b>PF / FE</b> displays on the screen	The unit has a self-diagnosis system to identify a number of malfunctions	Refer to the 'Self-Diagnosis'

If you notice or experience any of the following conditions, please turn off the air conditioner, disconnect from power, discontinue use, and contact support immediately.

- The power cord is overheating or otherwise damaged
- Abnormal sound during operation
- A strange odor is emitted from the unit
- Excessive water leakage the unit

Do not attempt to repair or retrofit the air conditioner by yourself. All repairs must be performed by qualified individuals.

## WARRANTY & CUSTOMER SUPPORT

### Warranty

TURBRO provides a 1-year limited warranty for TURBRO products from the date of purchase, subject to the following conditions and limitations outlined below.

#### What is covered?

- This warranty is limited to the repair or replacement of part(s) proved to be defective in material or workmanship, after said defect is confirmed by the manufacturer's inspection.
- The manufacturer may, at its discretion, fully discharge all obligations with respect to this warranty by refunding the wholesale price of the defective part(s).

**What is not covered?**

- Damage caused by the owner when attempting to fix or alter the product themselves.
- Damage caused by misuse, abuse, neglect, alterations, or unauthorized repair.
- Natural depreciation.
- Any alteration misuse of the product will nullify this warranty.
- This warranty is non-transferable, which is effective for the original buyer from the authorized seller only.

**How to request warranty services?**

To obtain the benefit of this warranty, please leave a message online ([www.turbro.com/contact](http://www.turbro.com/contact)), or send an email to [support@turbro.com](mailto:support@turbro.com).

**What will TURBRO do?**

- Repair the item.
- Replace the item if not repairable.
- Refund the item under certain circumstances.

**CUSTOMER SUPPORT****We are here to help anytime!**

Any problems, write to us via [support@turbro.com](mailto:support@turbro.com). We will get back to you within 1 business day.

**TURBRO**

www.turbro.com

