



BROCKWELL INCORPORATED

www.COLUMNSDIRECT.com



P.O. BOX 1283 ▪ MADISON, TN 37116 ▪ **PHONE:** 980-282-8383 ▪ **E-MAIL:** sales@columnsdirect.com

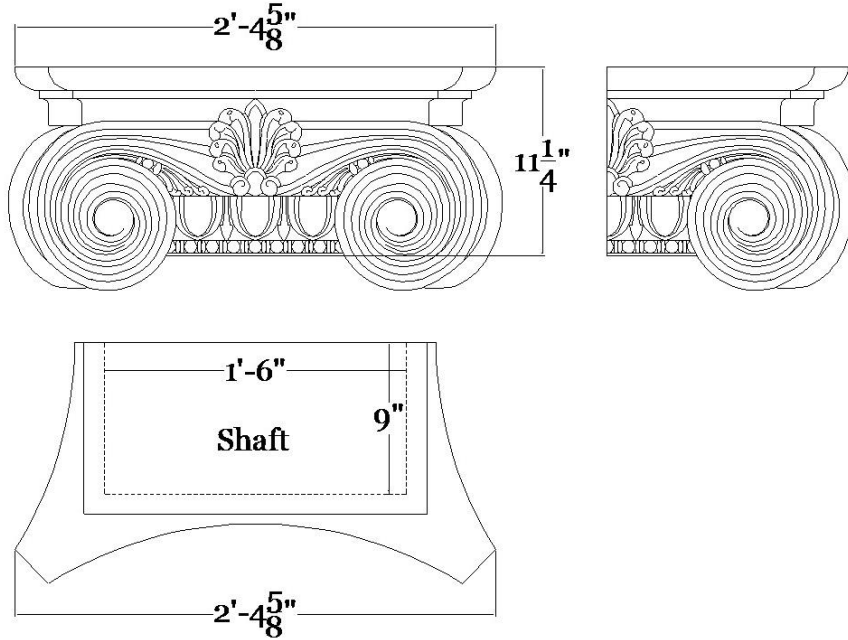

Shape: F | Half Square



Please specify your return (R) dimension when ordering. The return can be made 1/2 of the face width or less.

Example: For a 2" wide pilaster cap, the return dimension would 1" or less.

PLEASE NOTE: A small reveal where the capital meets the column shaft is created with all of our pilaster & column capitals. This reveal increases proportionally with the size of the capital.

Quantity:	Customer:
Product Name: Modern Empire Pilaster Capital	Approved:
Part #: CAP-ME-18-PLAS-F-2	Load-Bearing: No
Material: Plaster	Approximate Lead Time ____ Week(s) After Approved Shop Drawings
Dimensions: (W) 18" x (H) 11-1/4" x (Abac) 28-5/8"	* This product is Made to Order
CLIENT SIGNATURE:	DATE:

ALL RIGHTS RESERVED. THIS DRAWING IS THE PROPERTY OF BROCKWELL INCORPORATED AND MAY BE UTILIZED ONLY IN ASSOCIATION WITH PROJECTS IMPLEMENTING BROCKWELL INCORPORATED PRODUCTS. THIS DETAIL MAY NOT APPLY TO ALL CONDITIONS OR CONSTRUCTION SITUATIONS. FOR ALL OTHER SCENARIOS, PLEASE CONSULT WITH A BROCKWELL INCORPORATED CONSULTANT. | 980-282-8383 or sales@columnsdirect.com