



EVOTECH®
P E R F O R M A N C E

**Ducati Panigale V4
Radiator Guard Set**

Installation Instructions



Kit Contents PRN013860

- A** 12 x Rubber Bungs

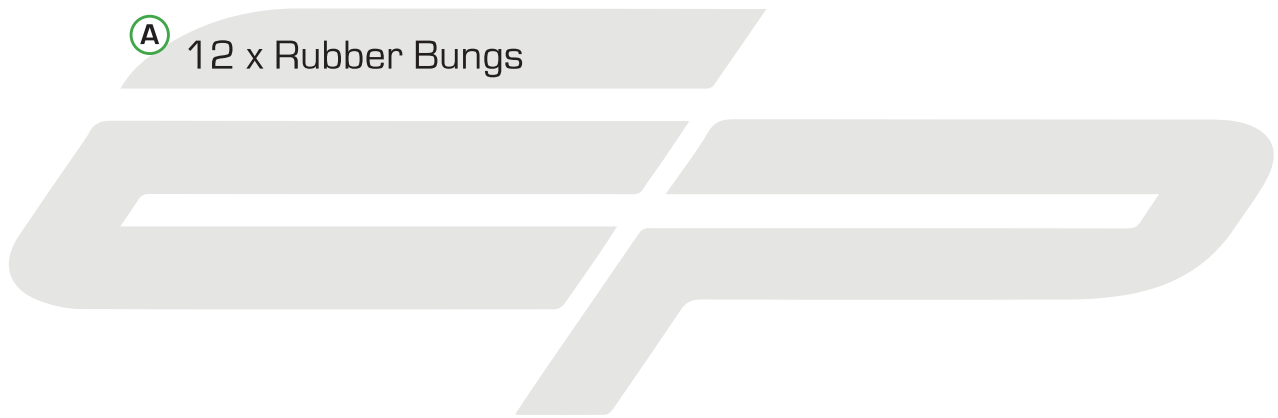

Installation Instructions

1

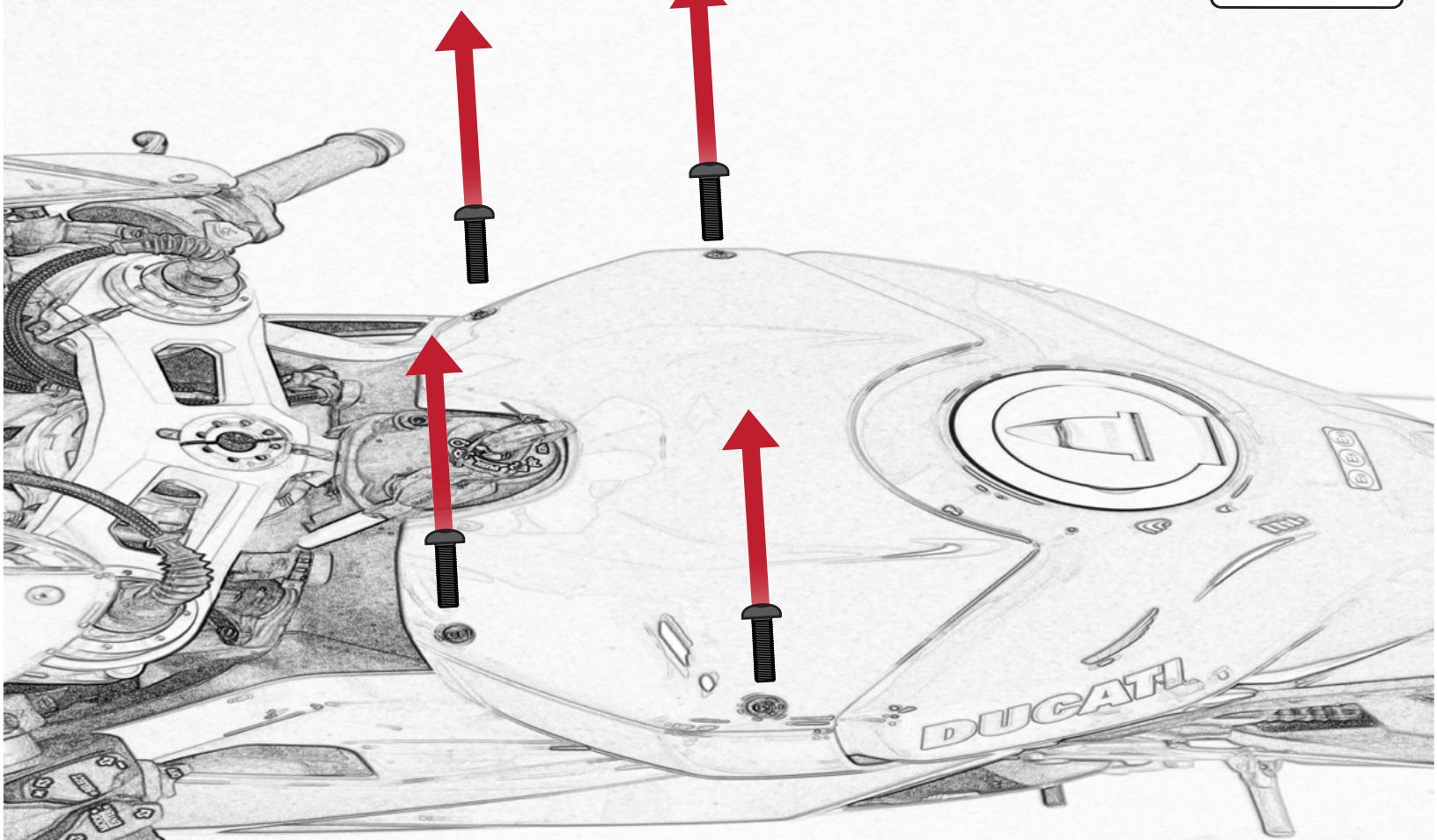

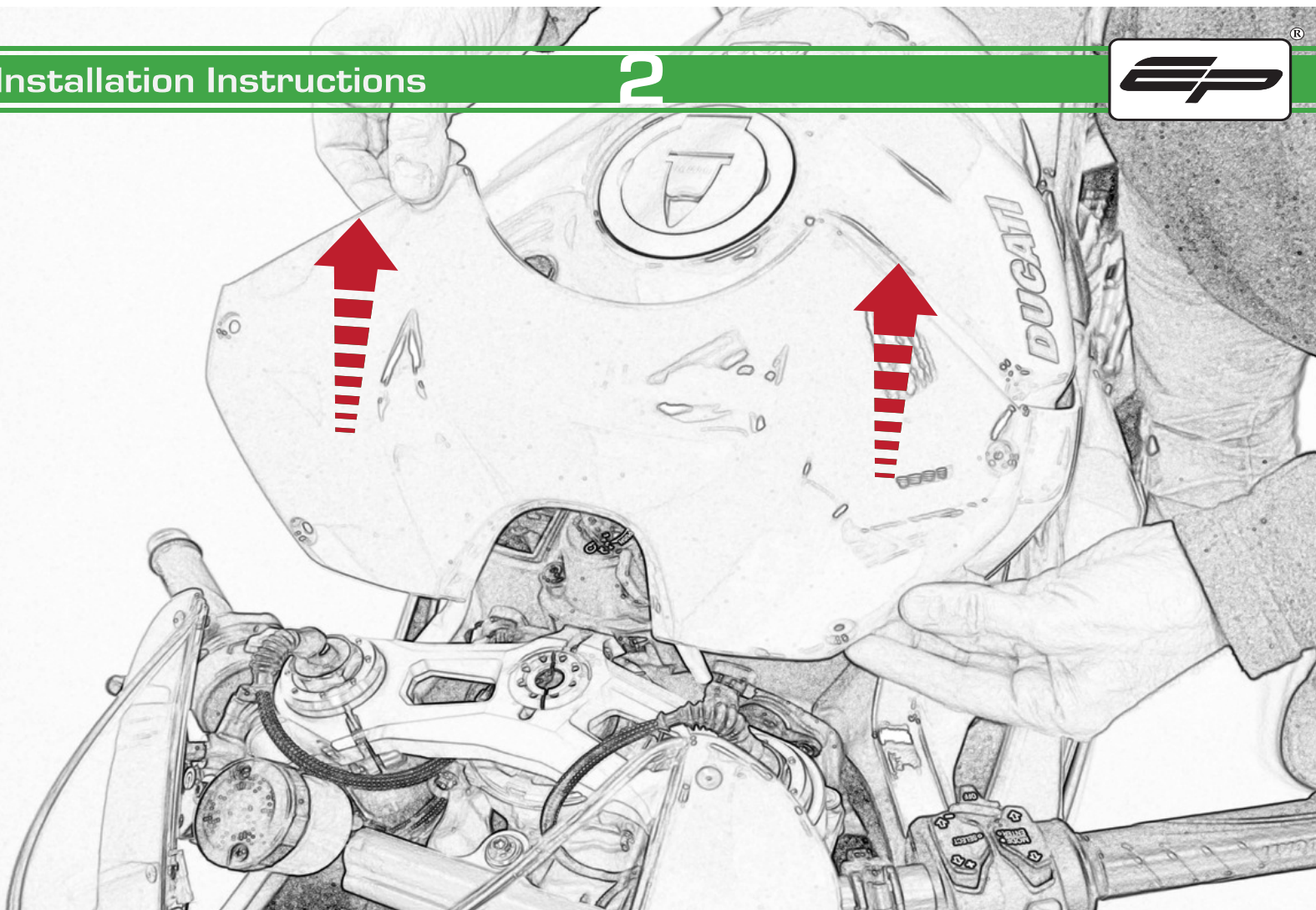

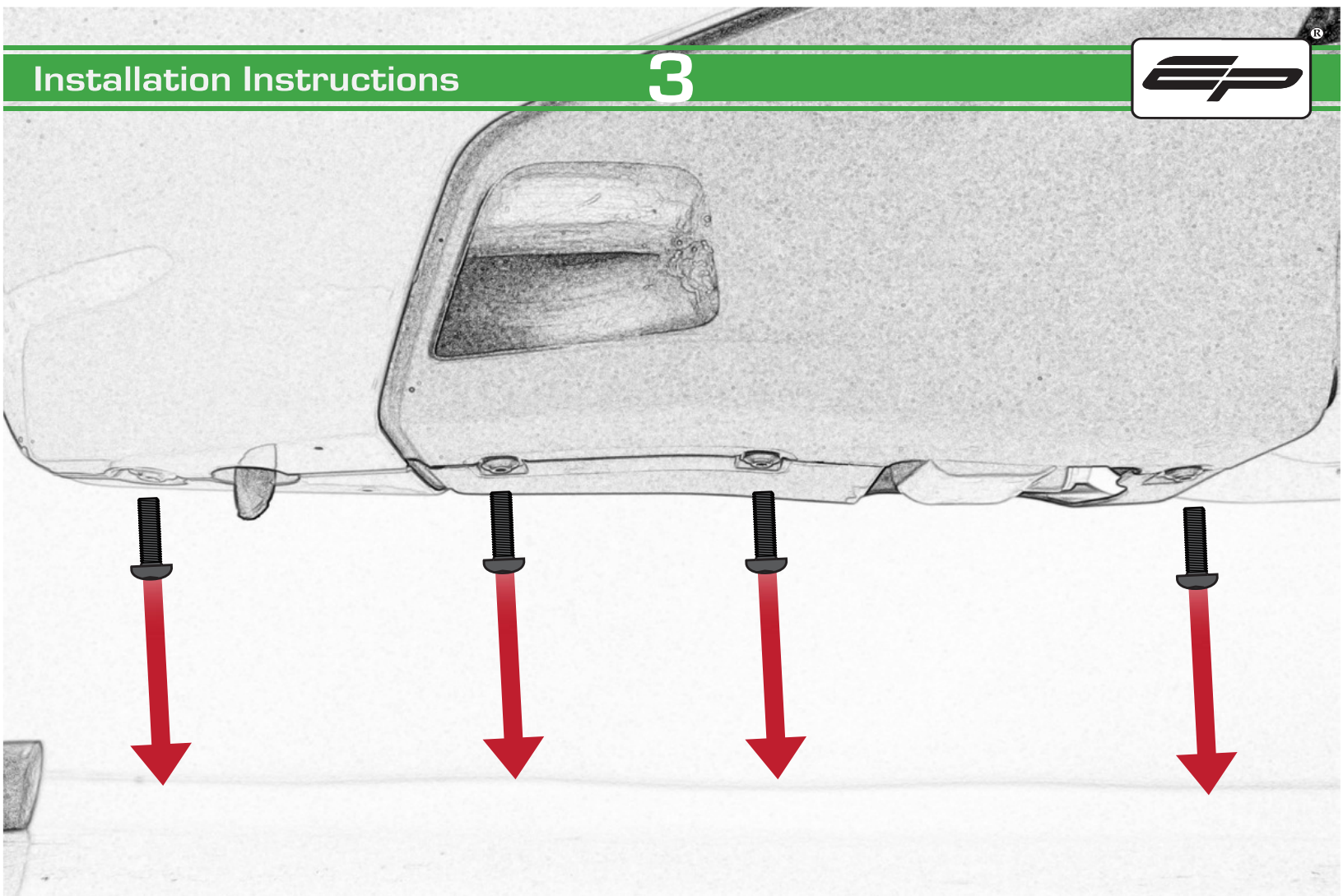

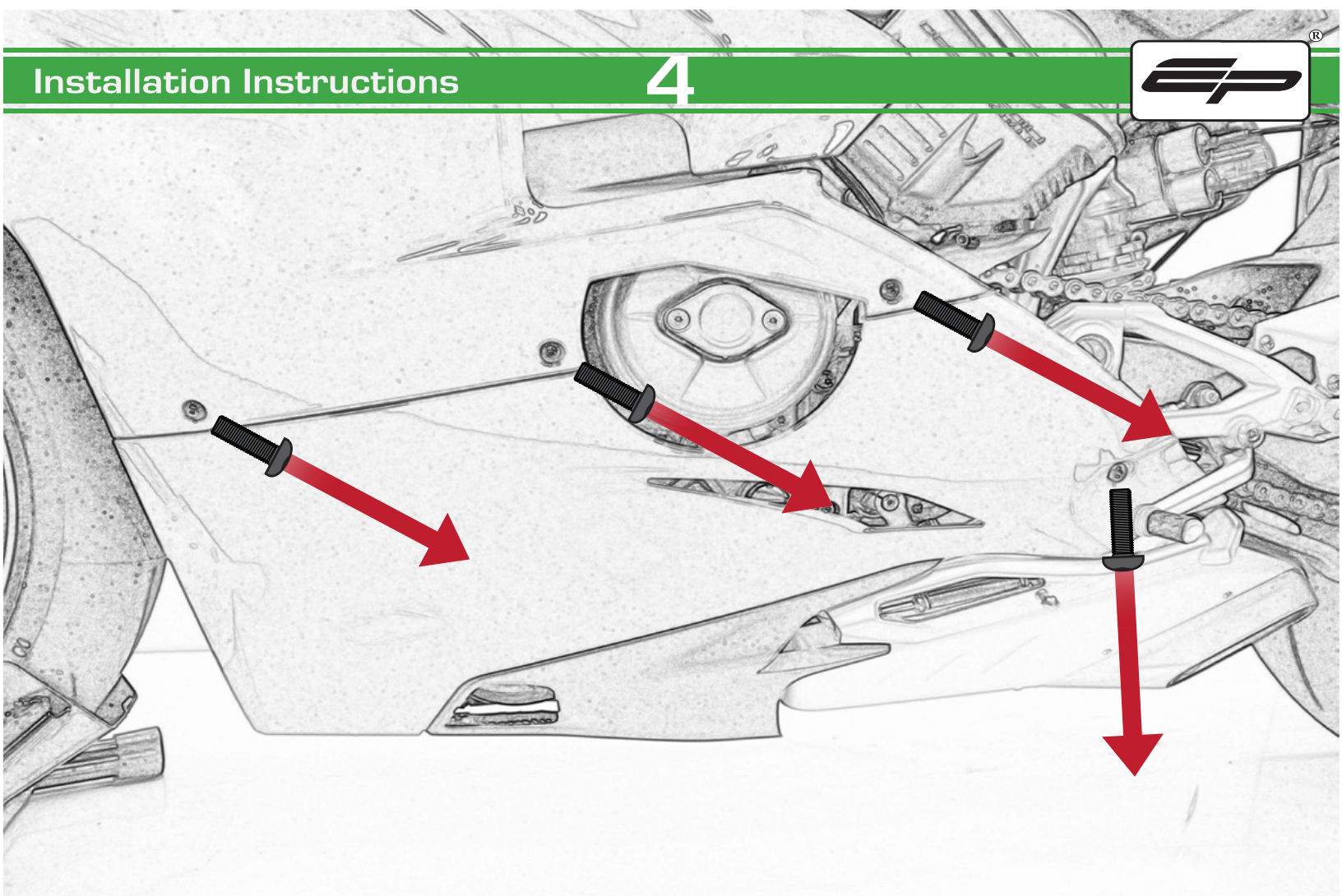

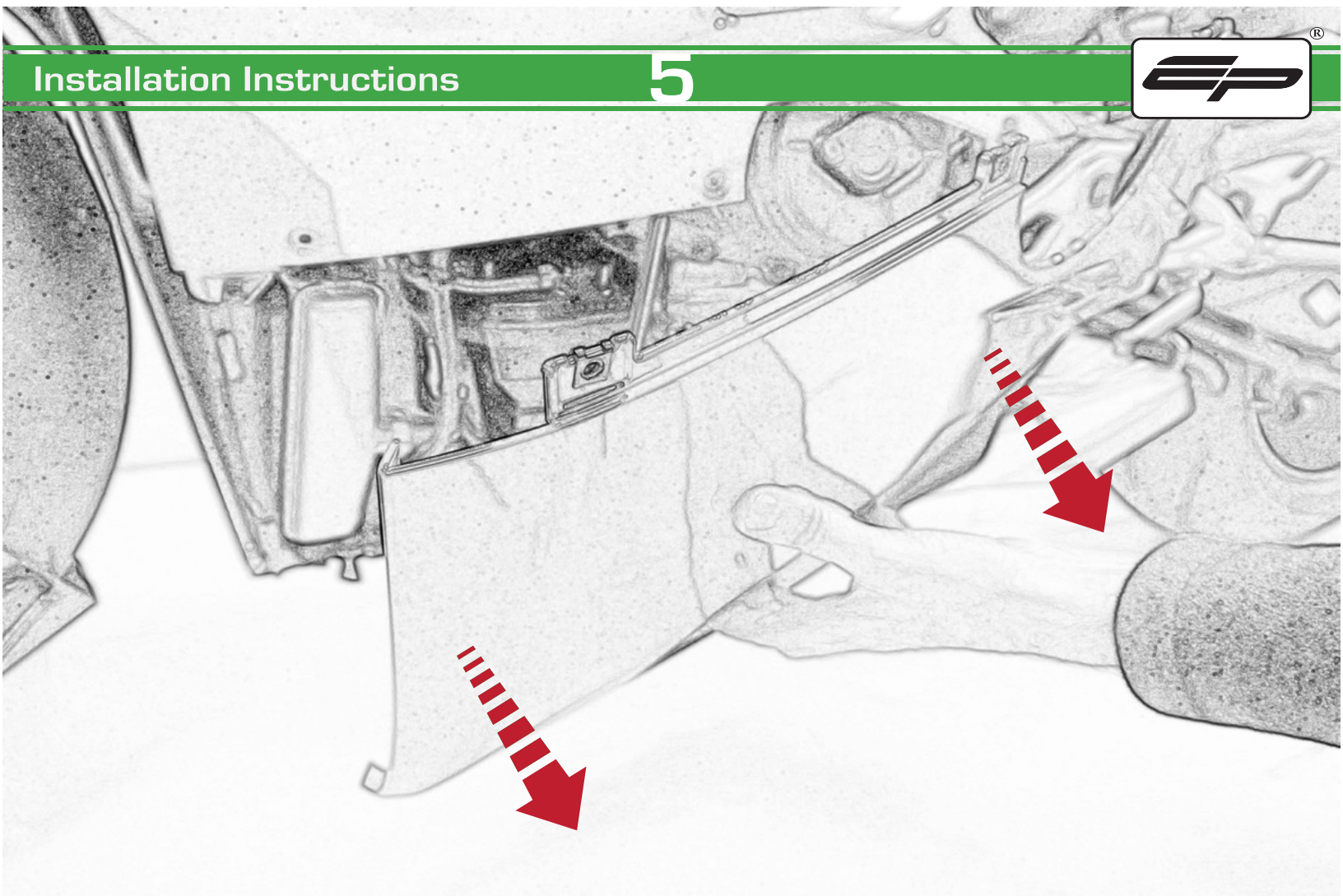

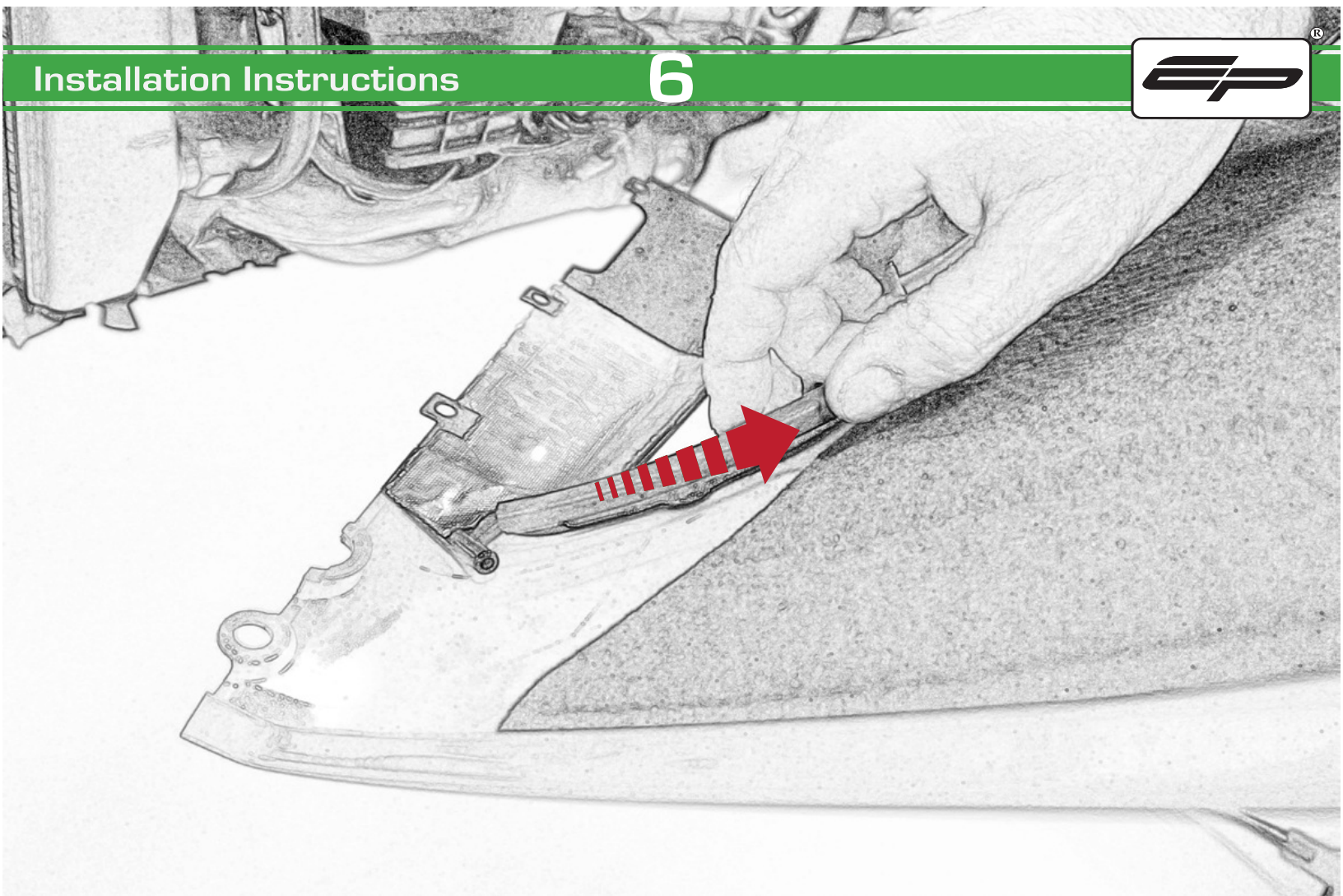

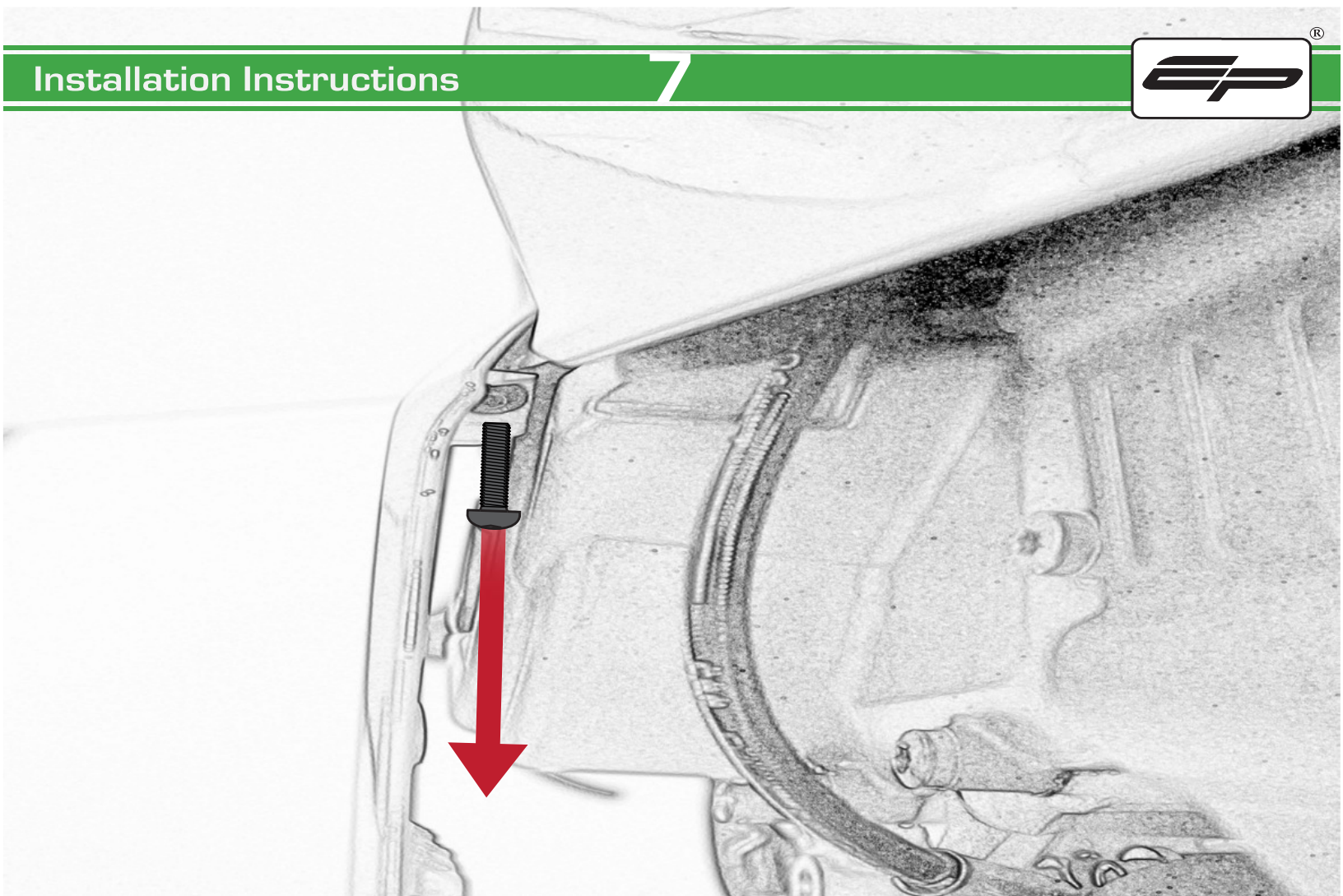

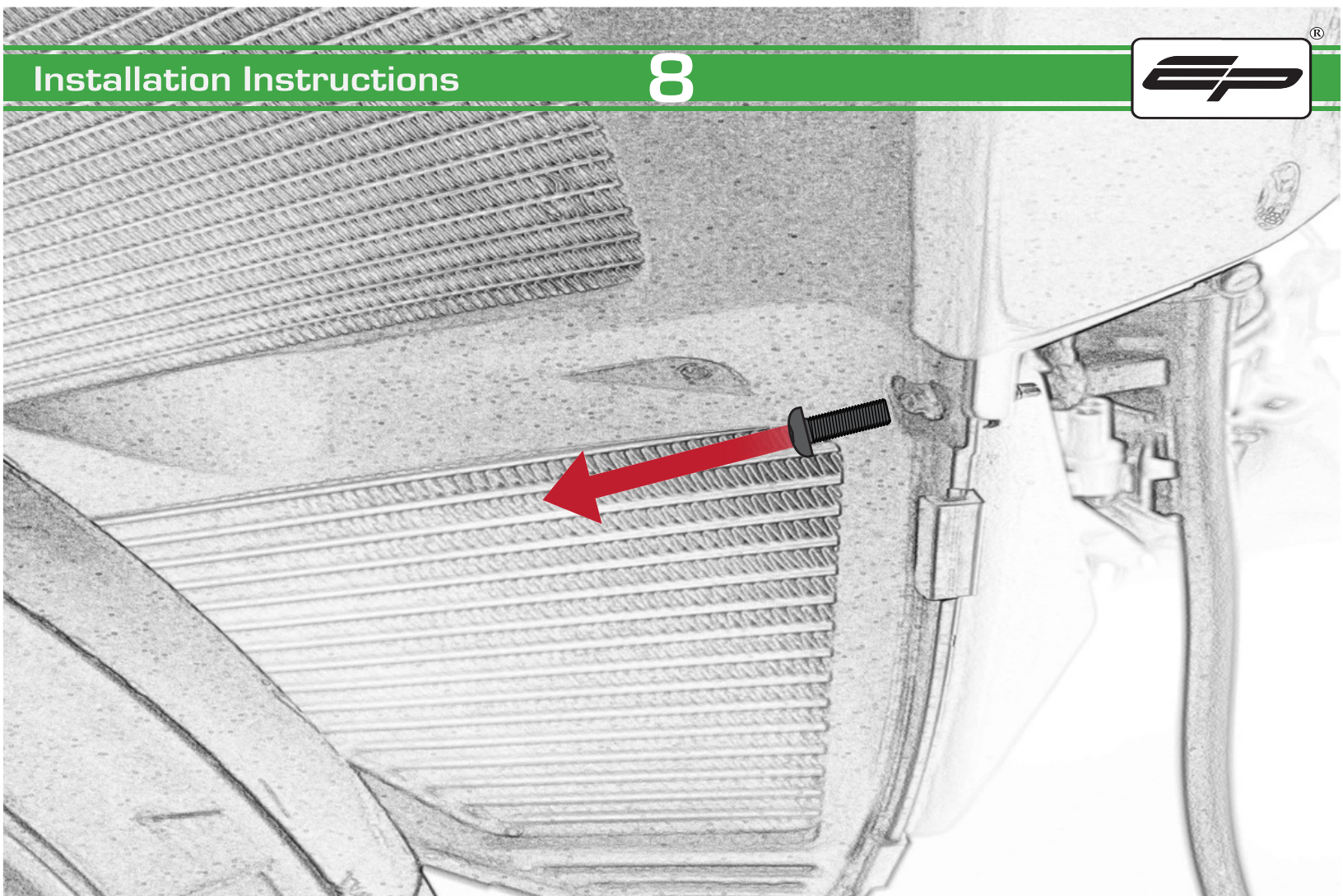

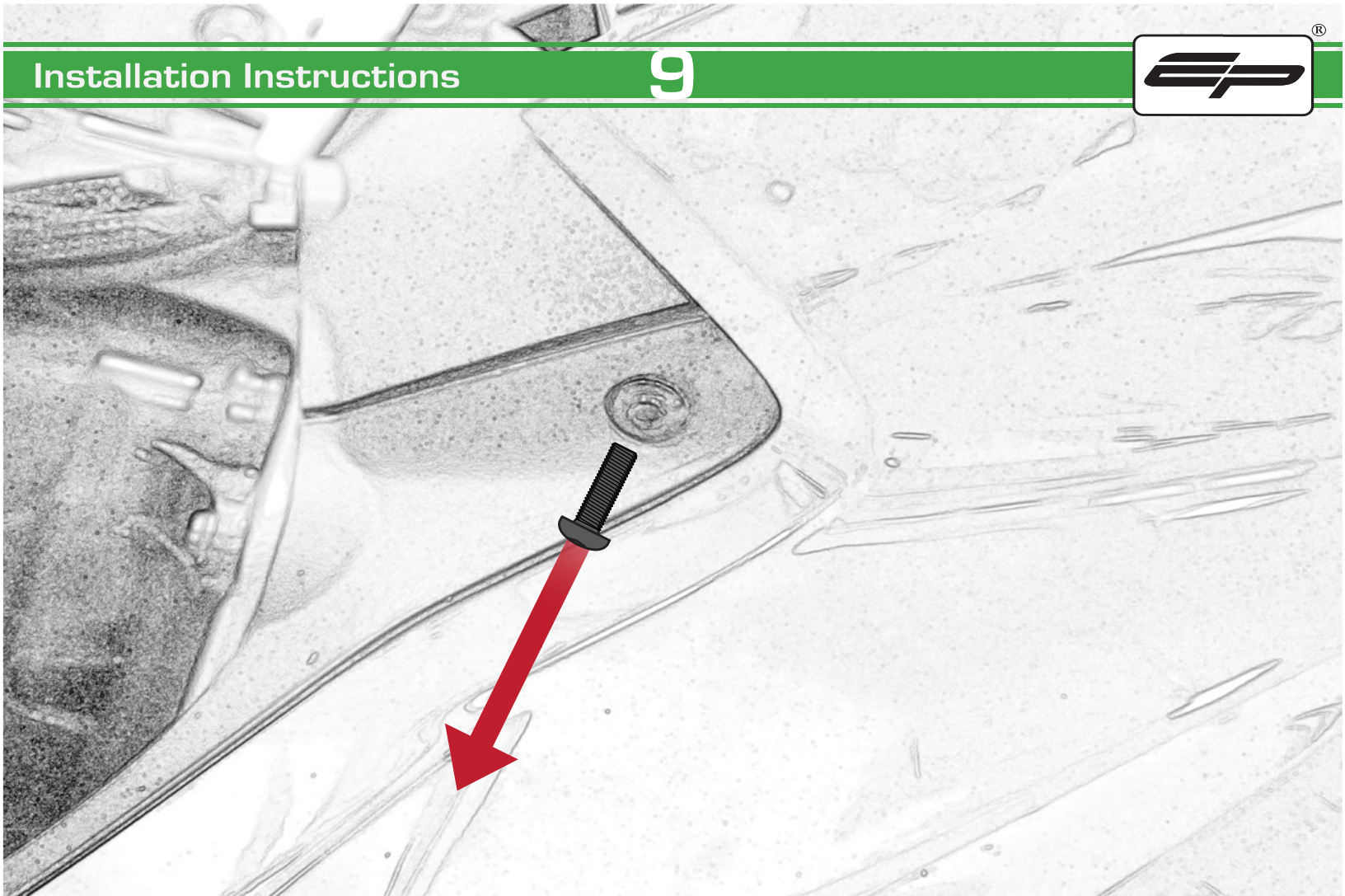

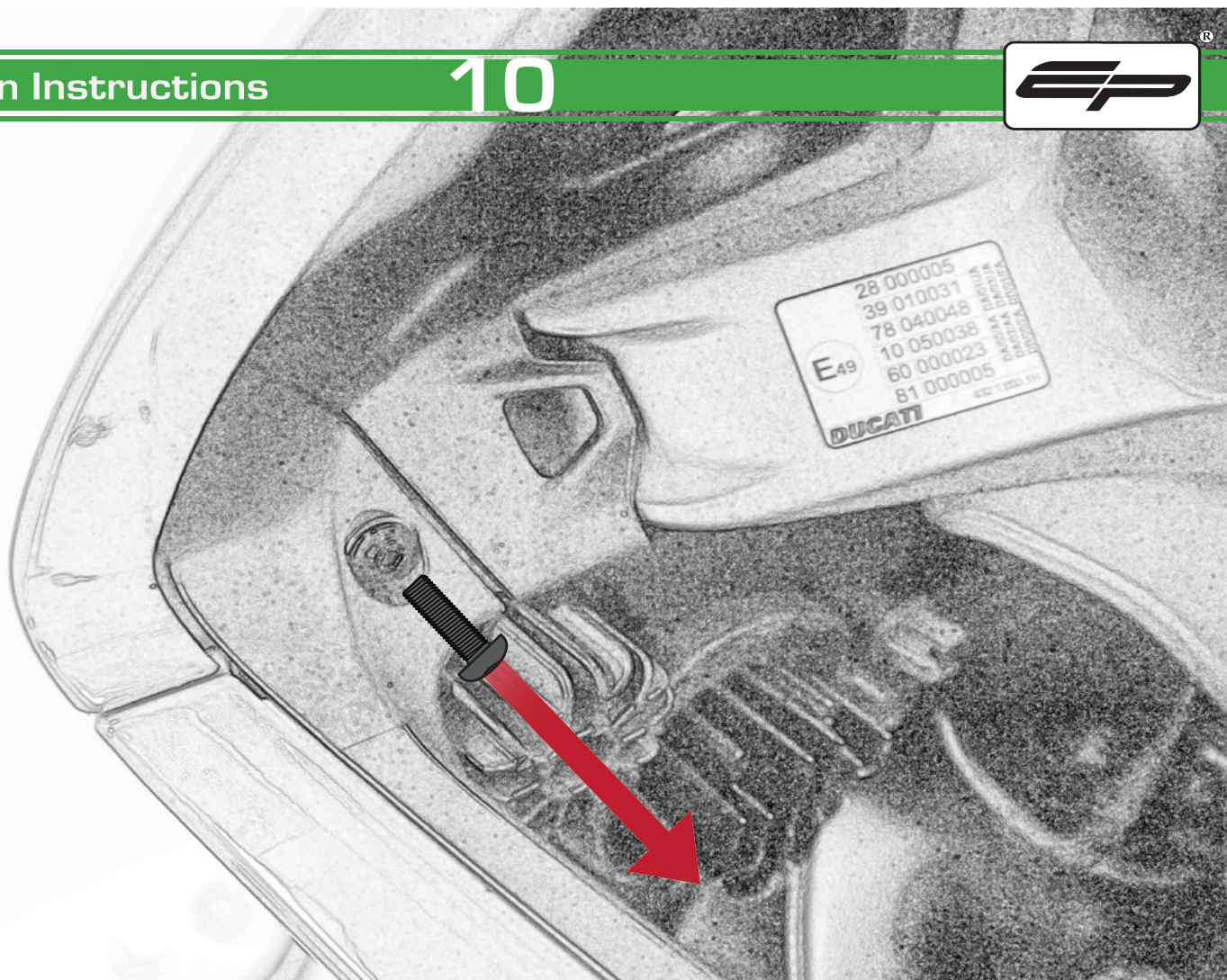

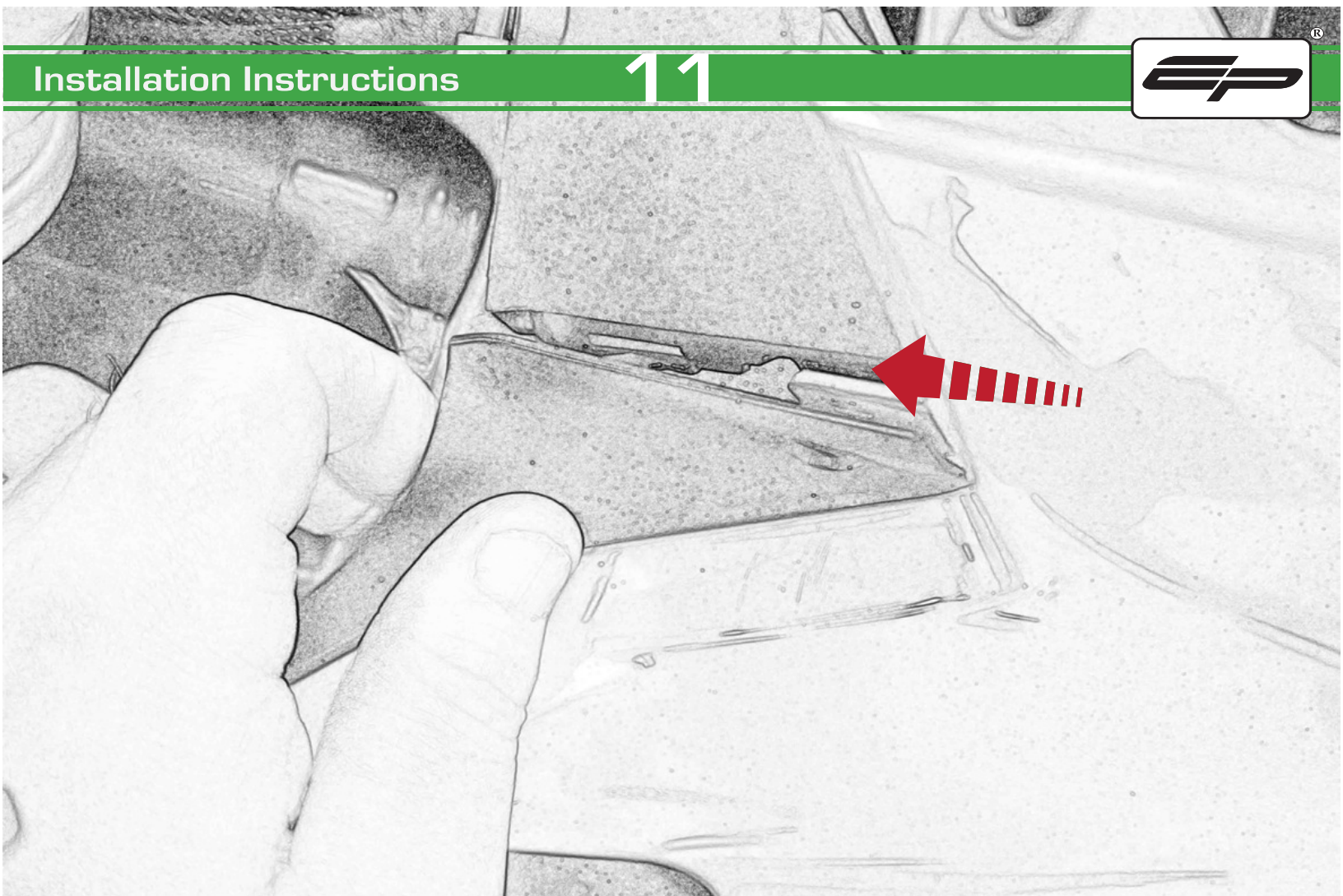

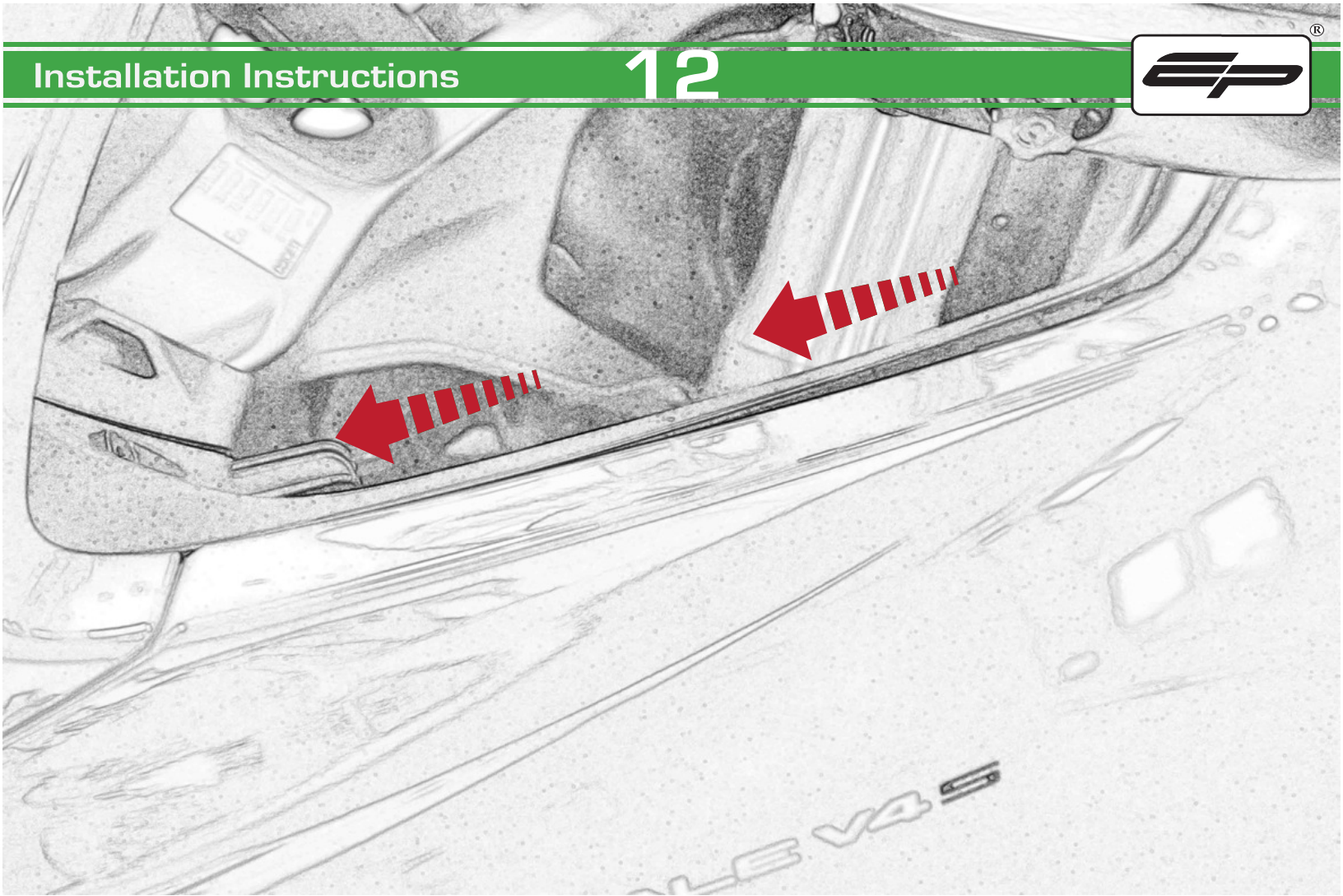

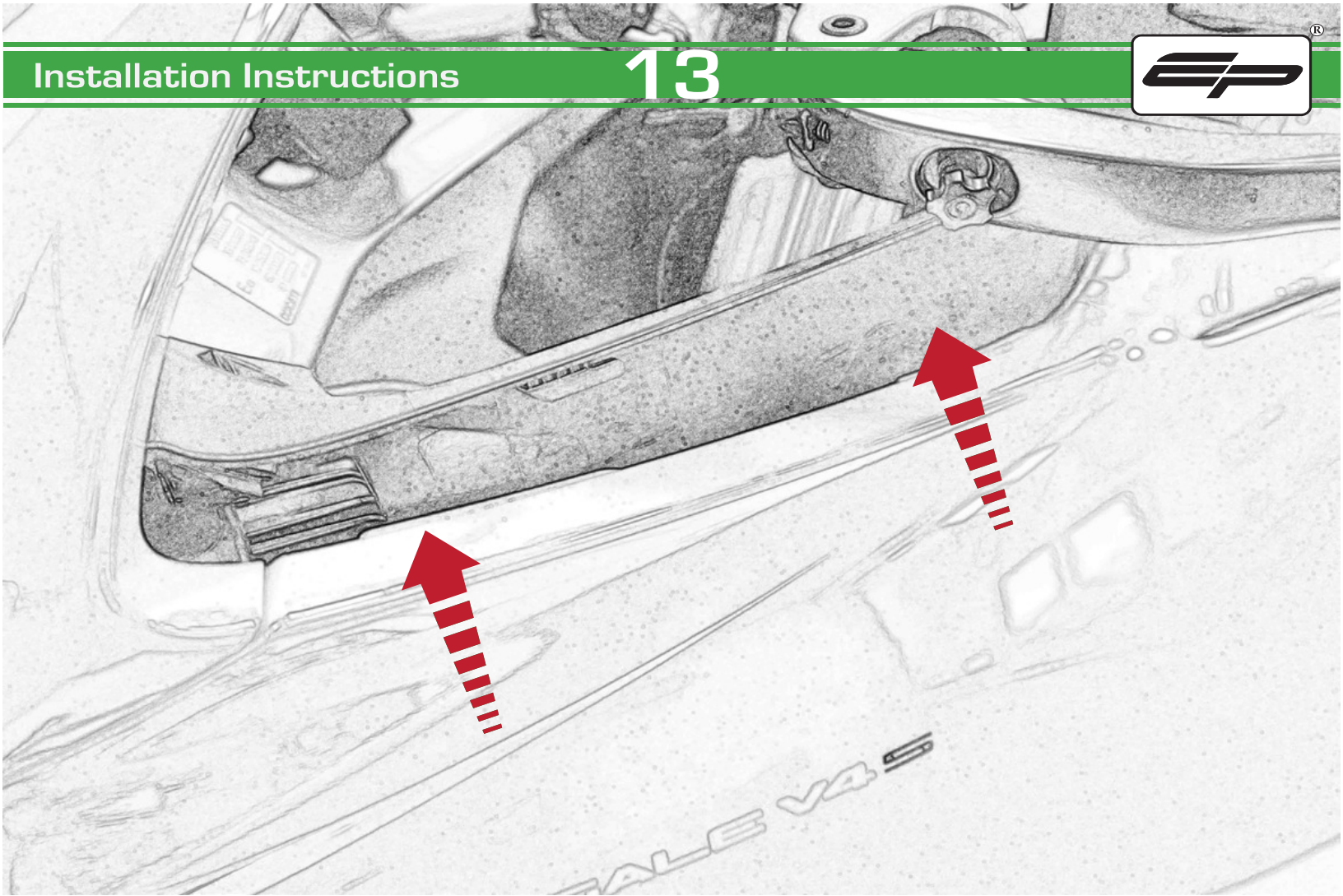

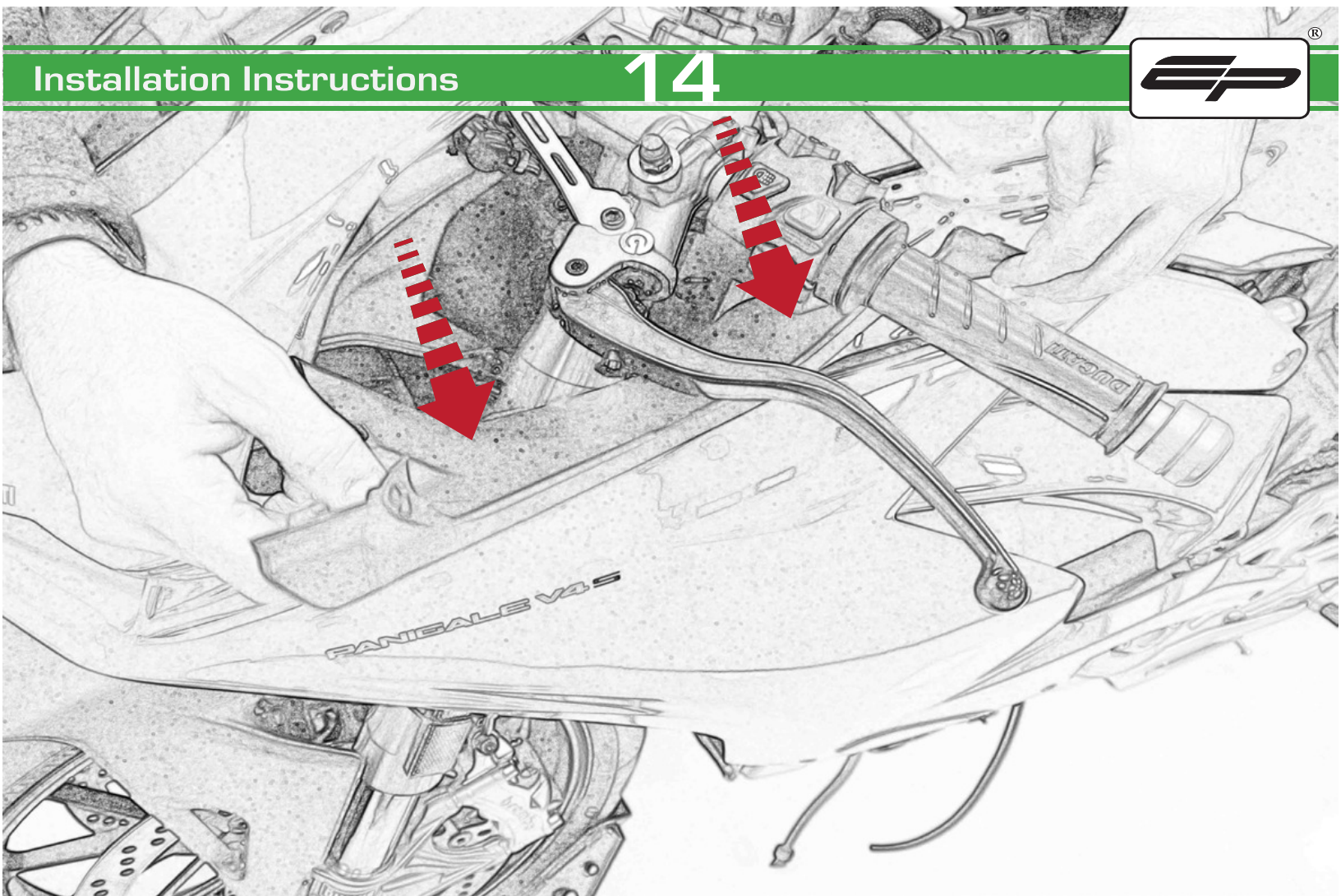

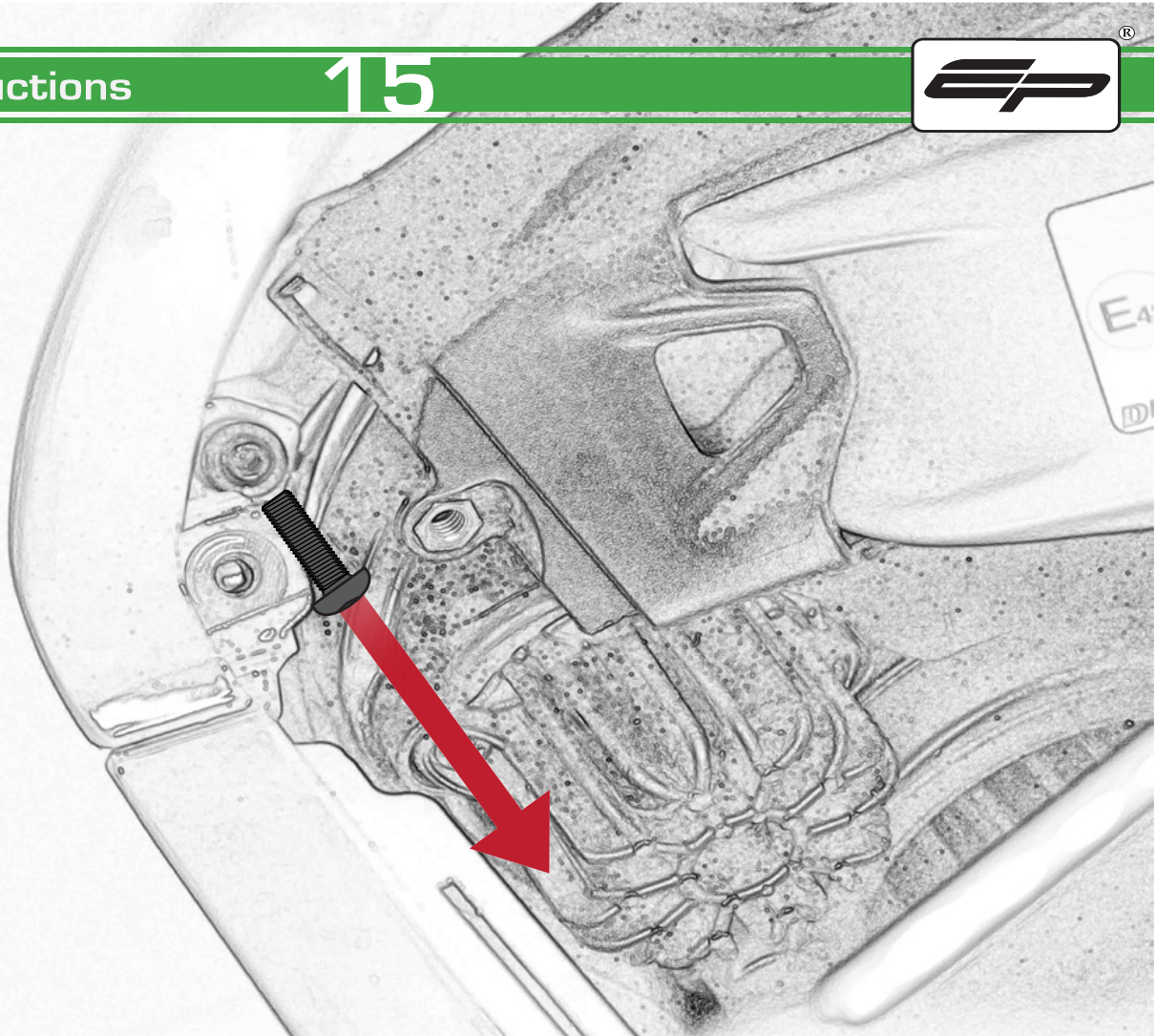

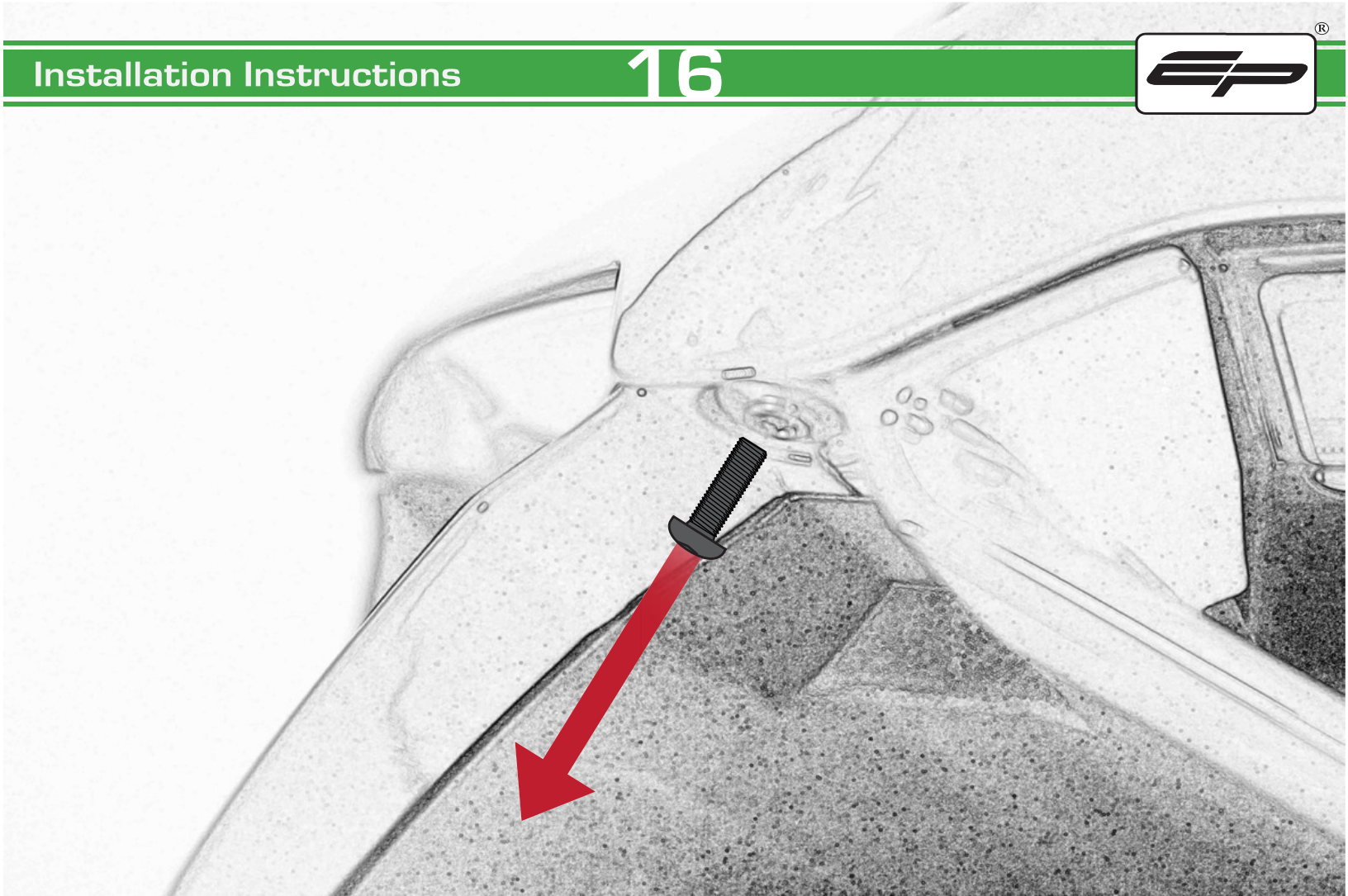

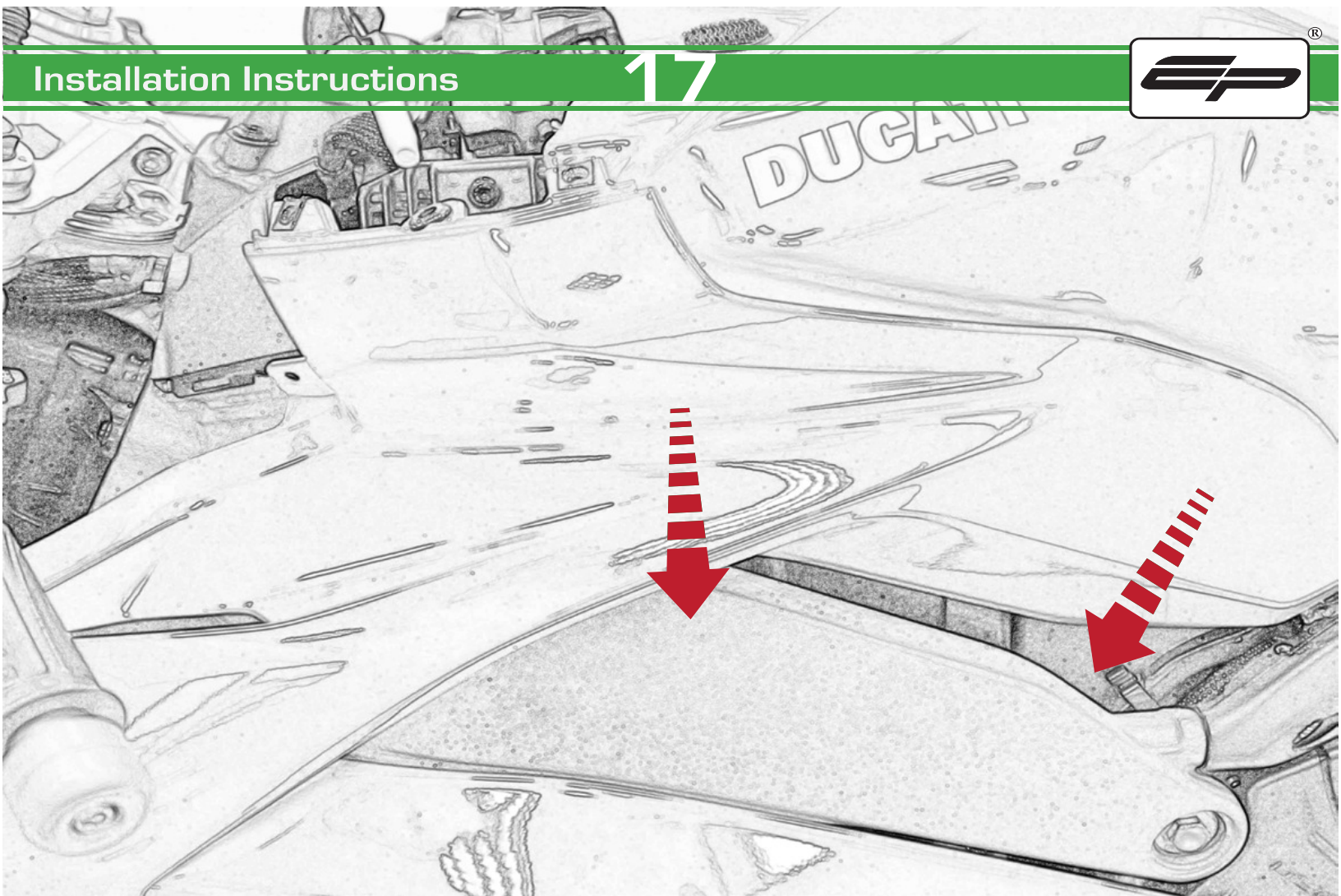

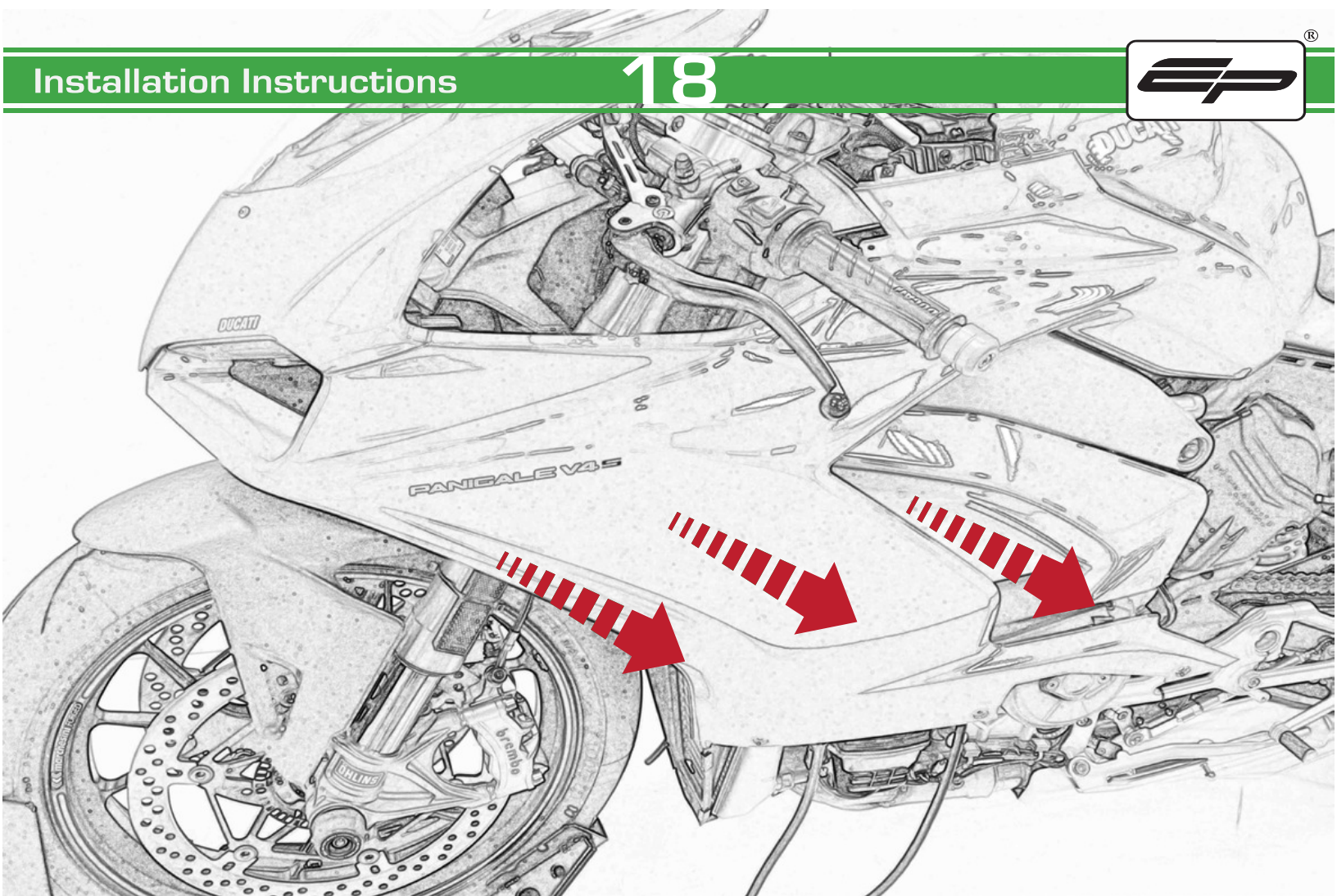

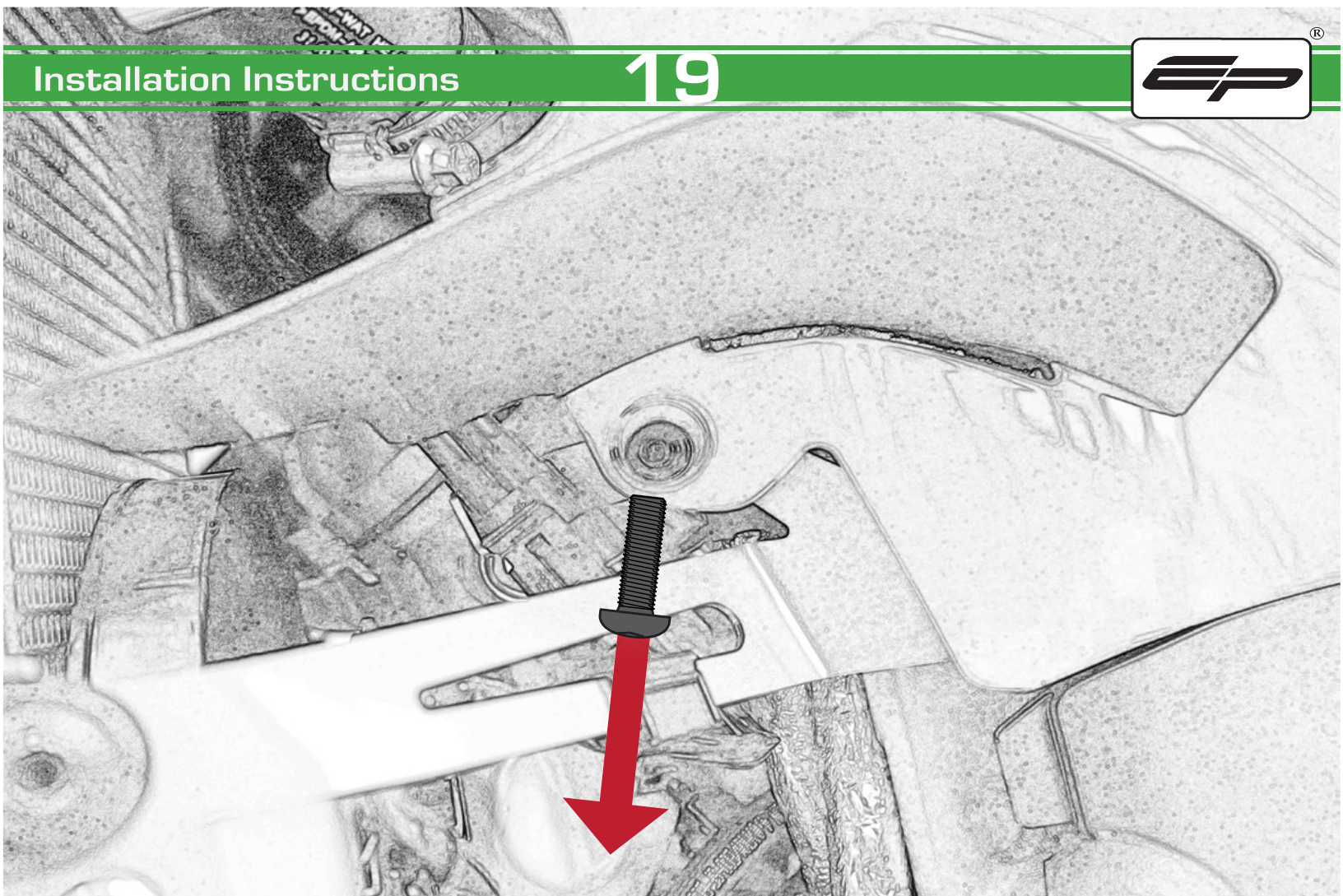

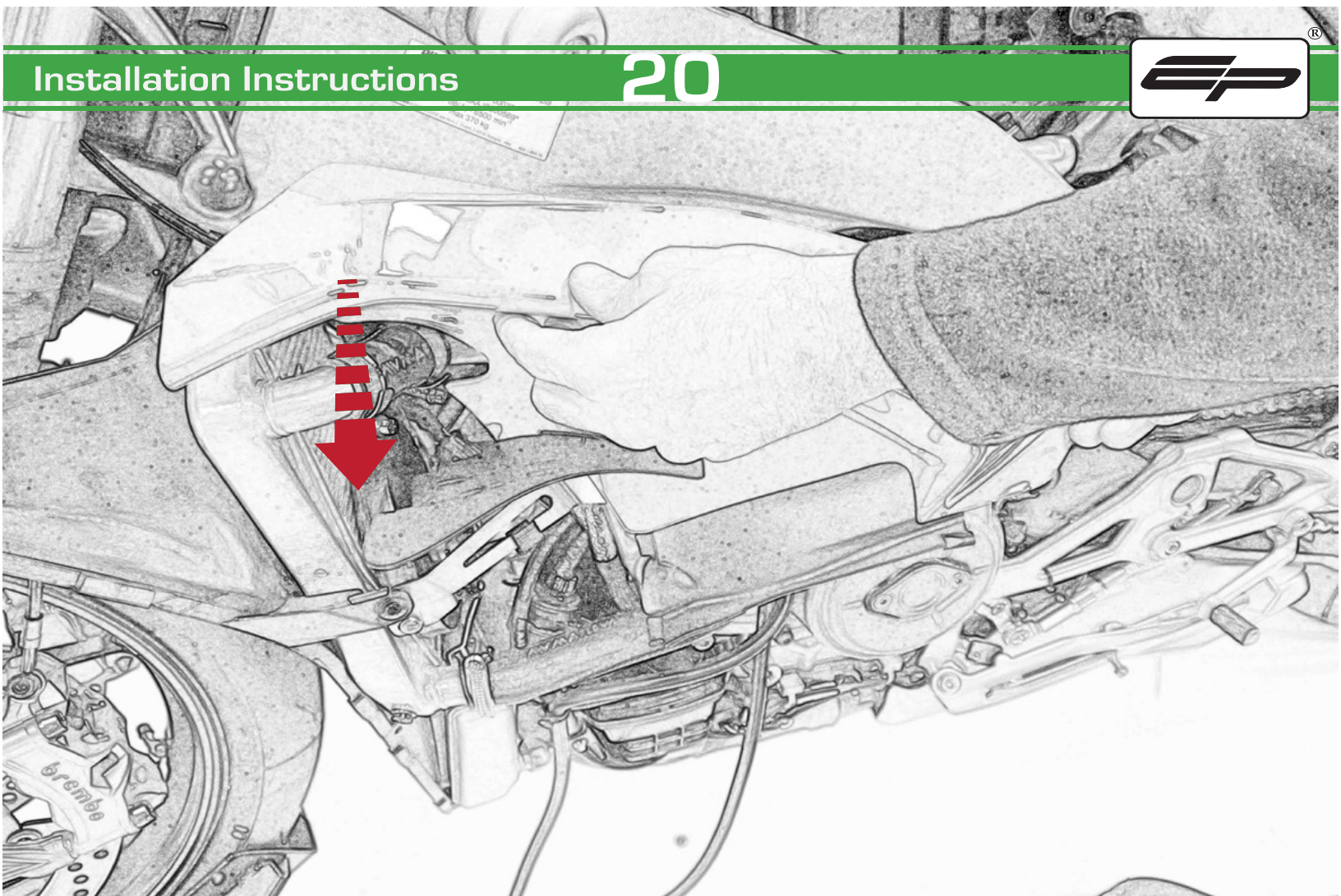

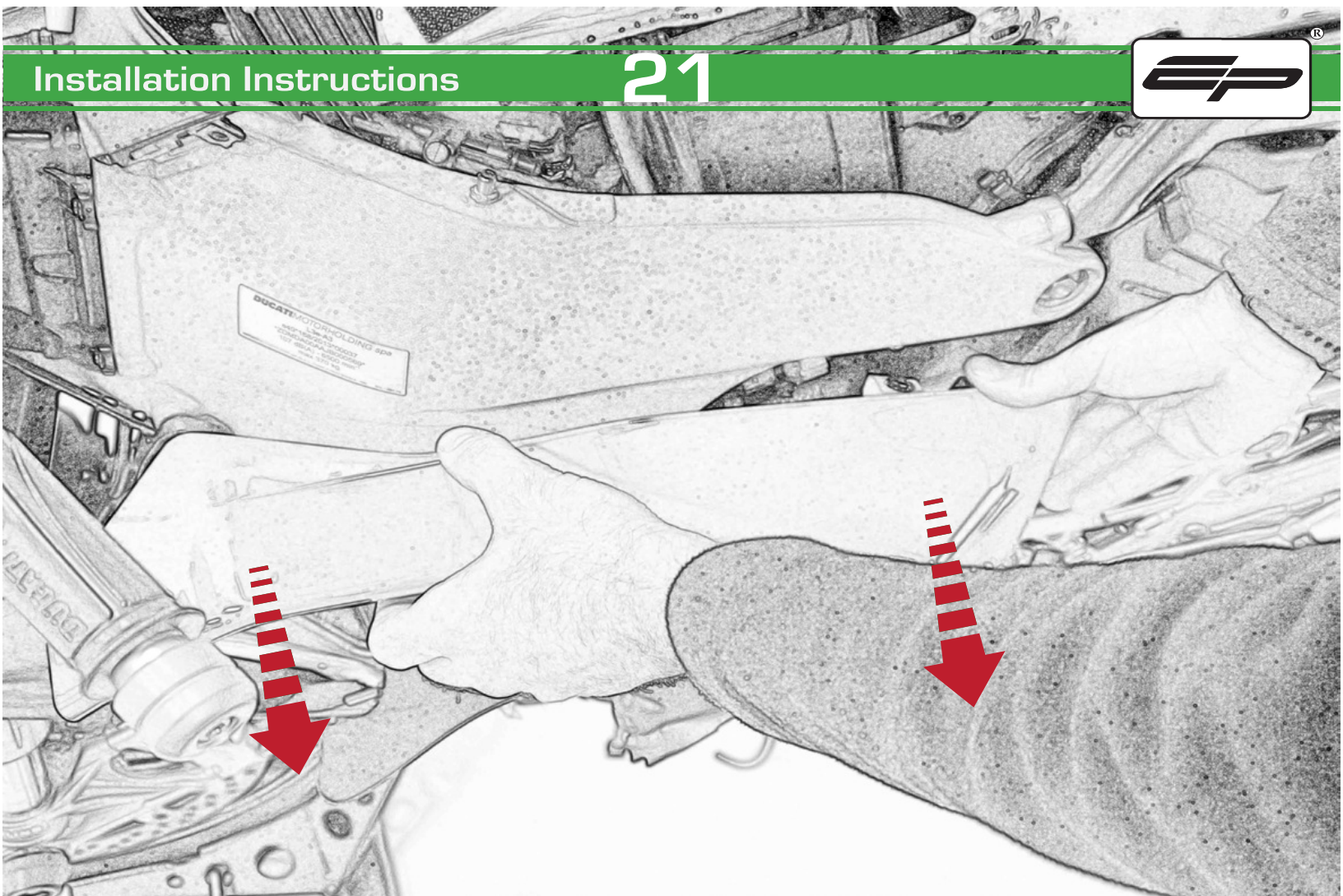

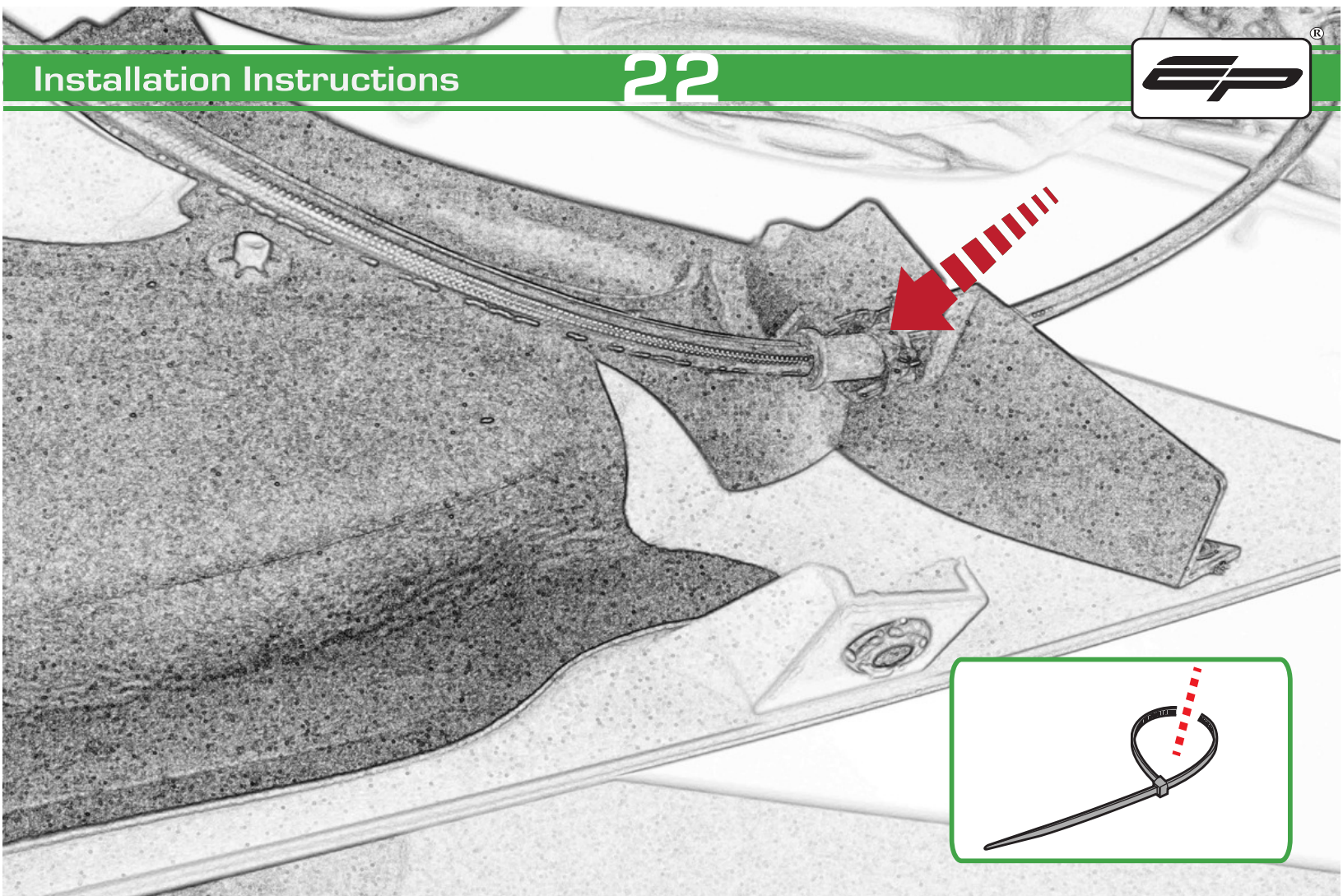

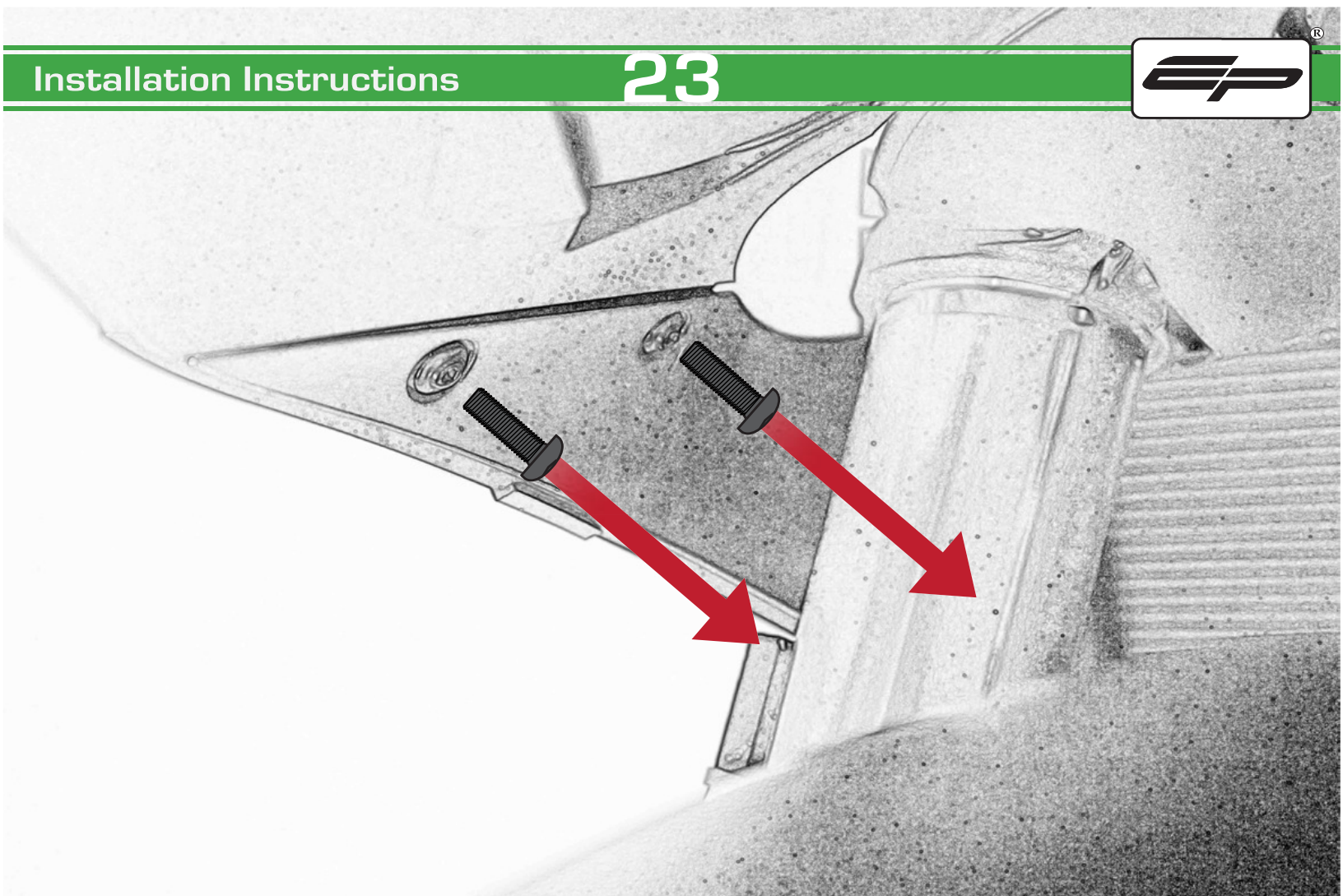

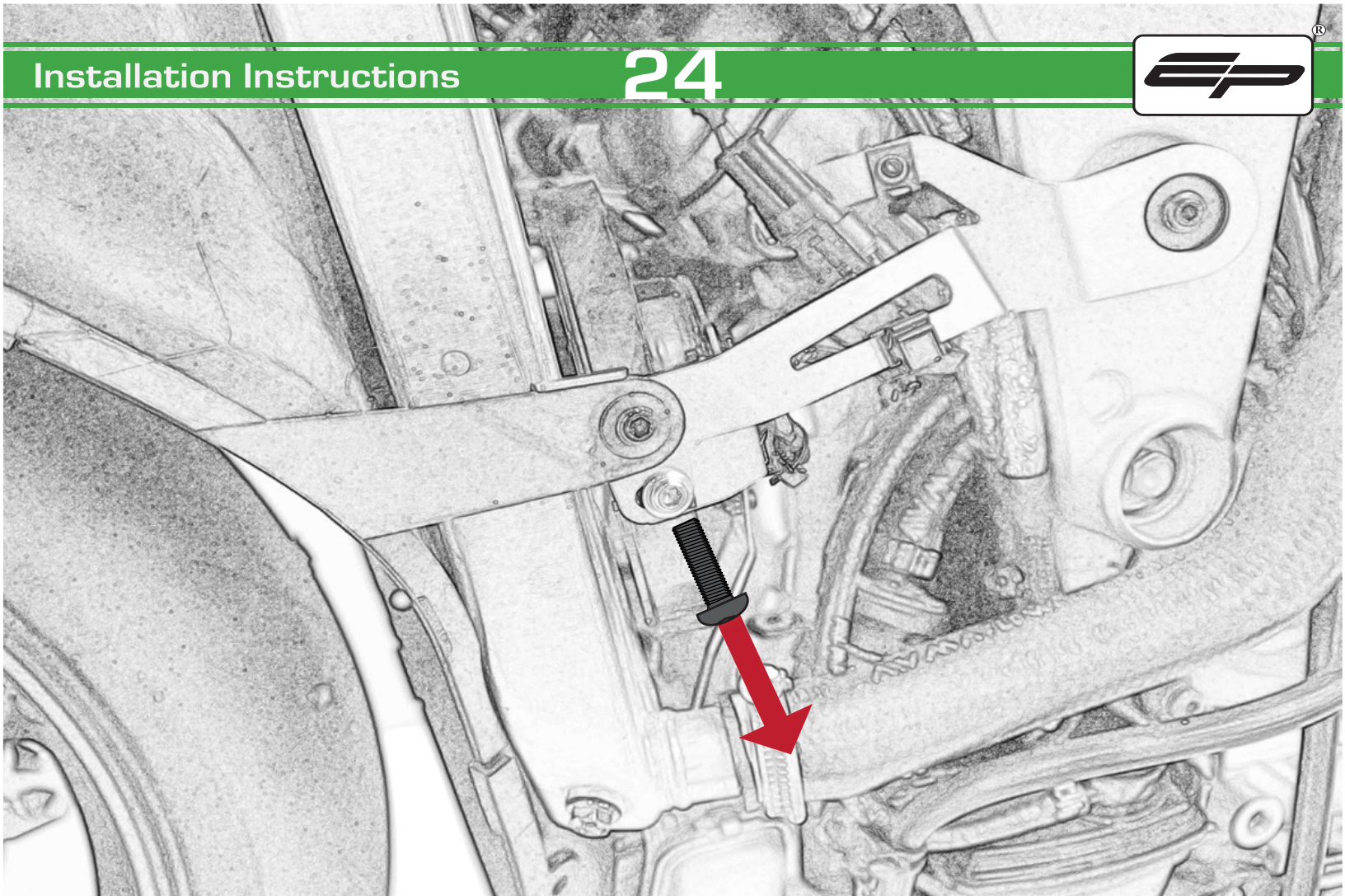

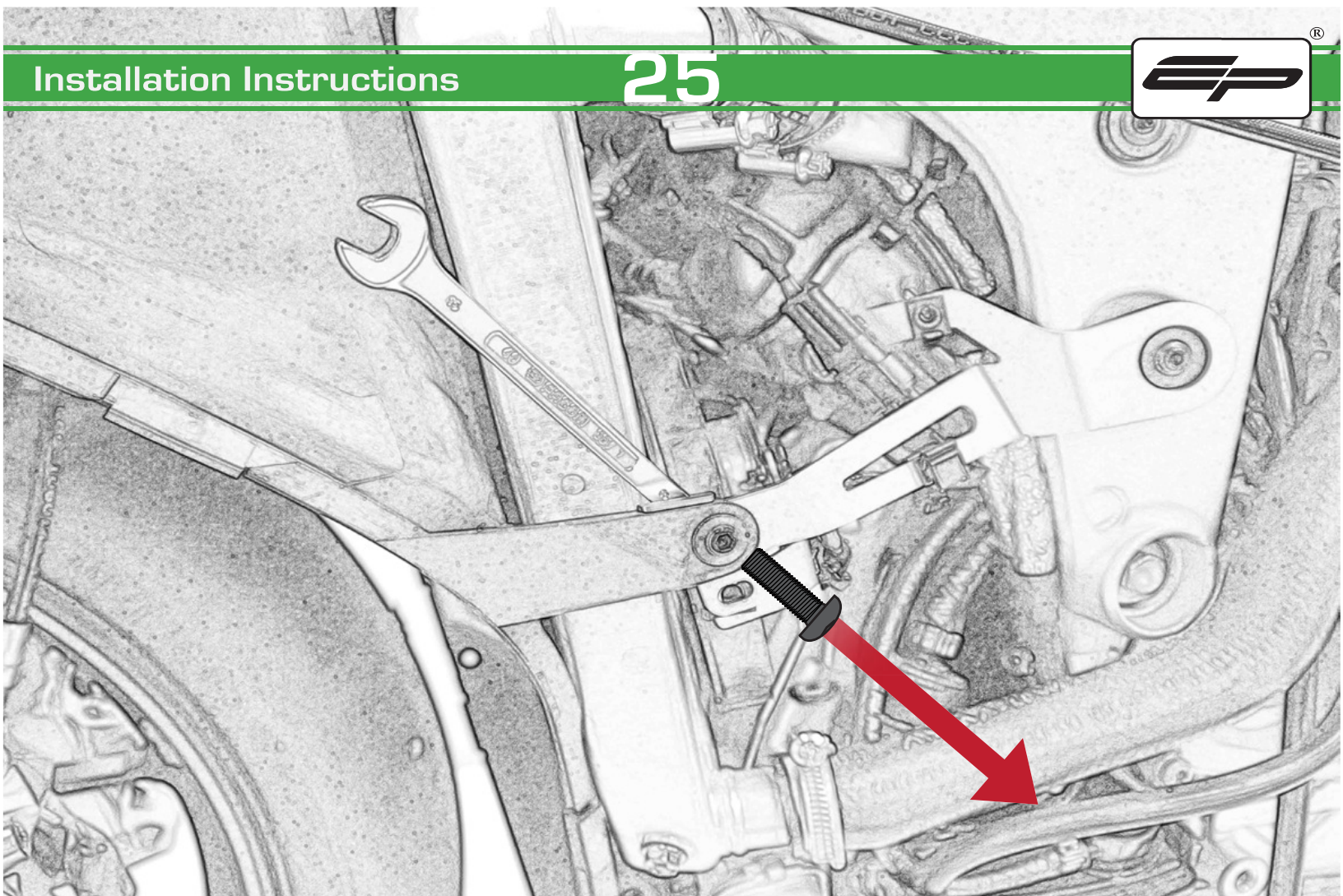

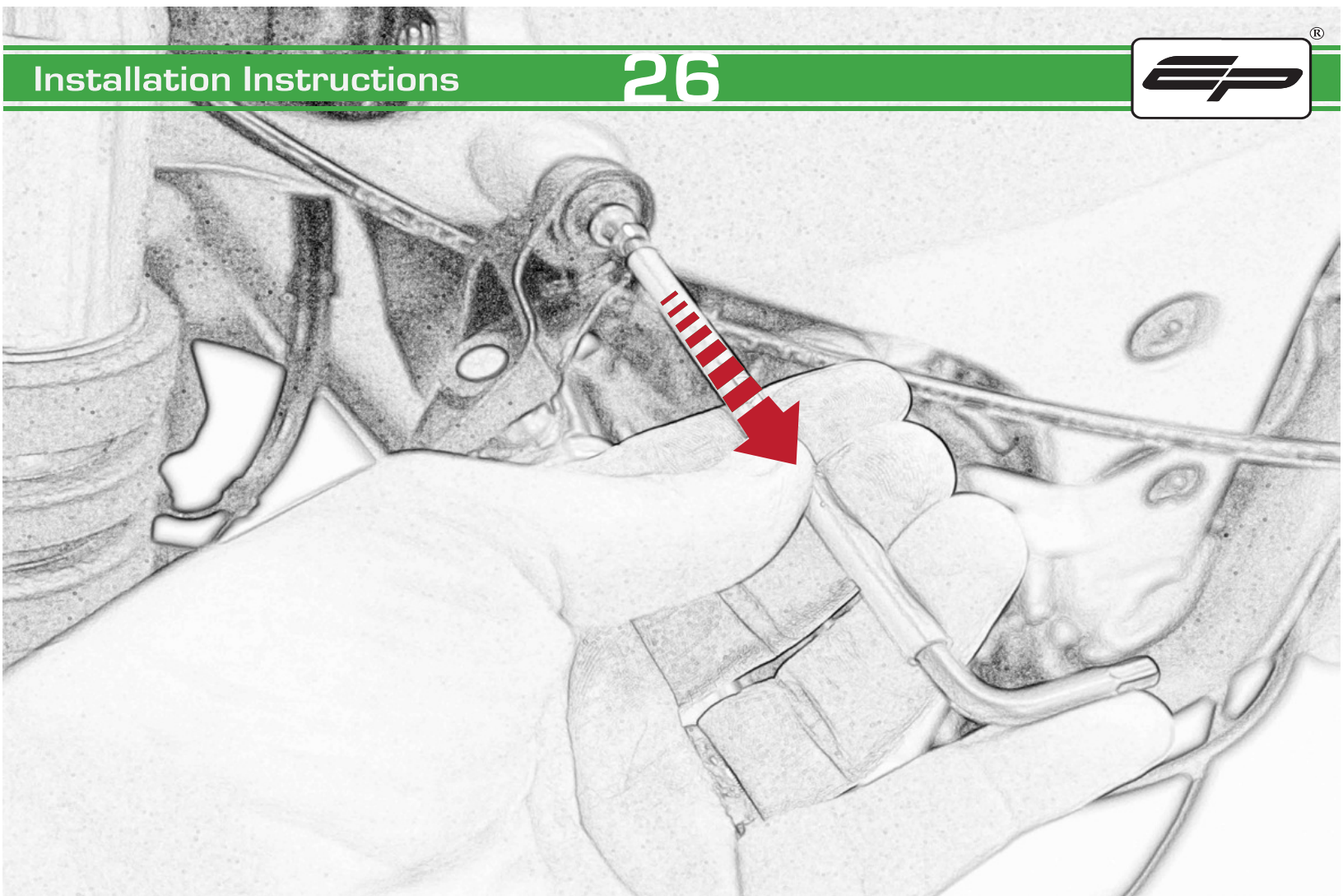

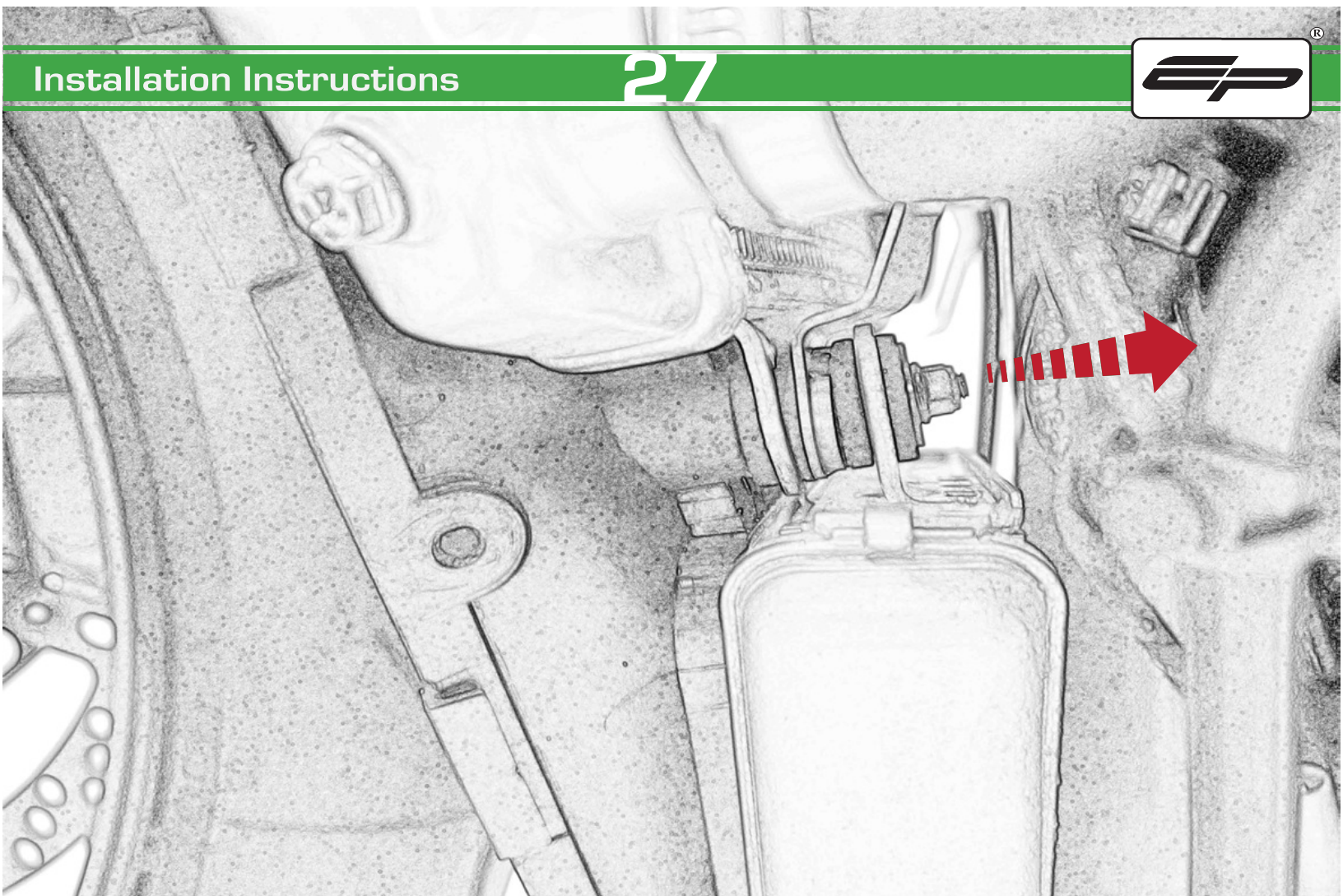

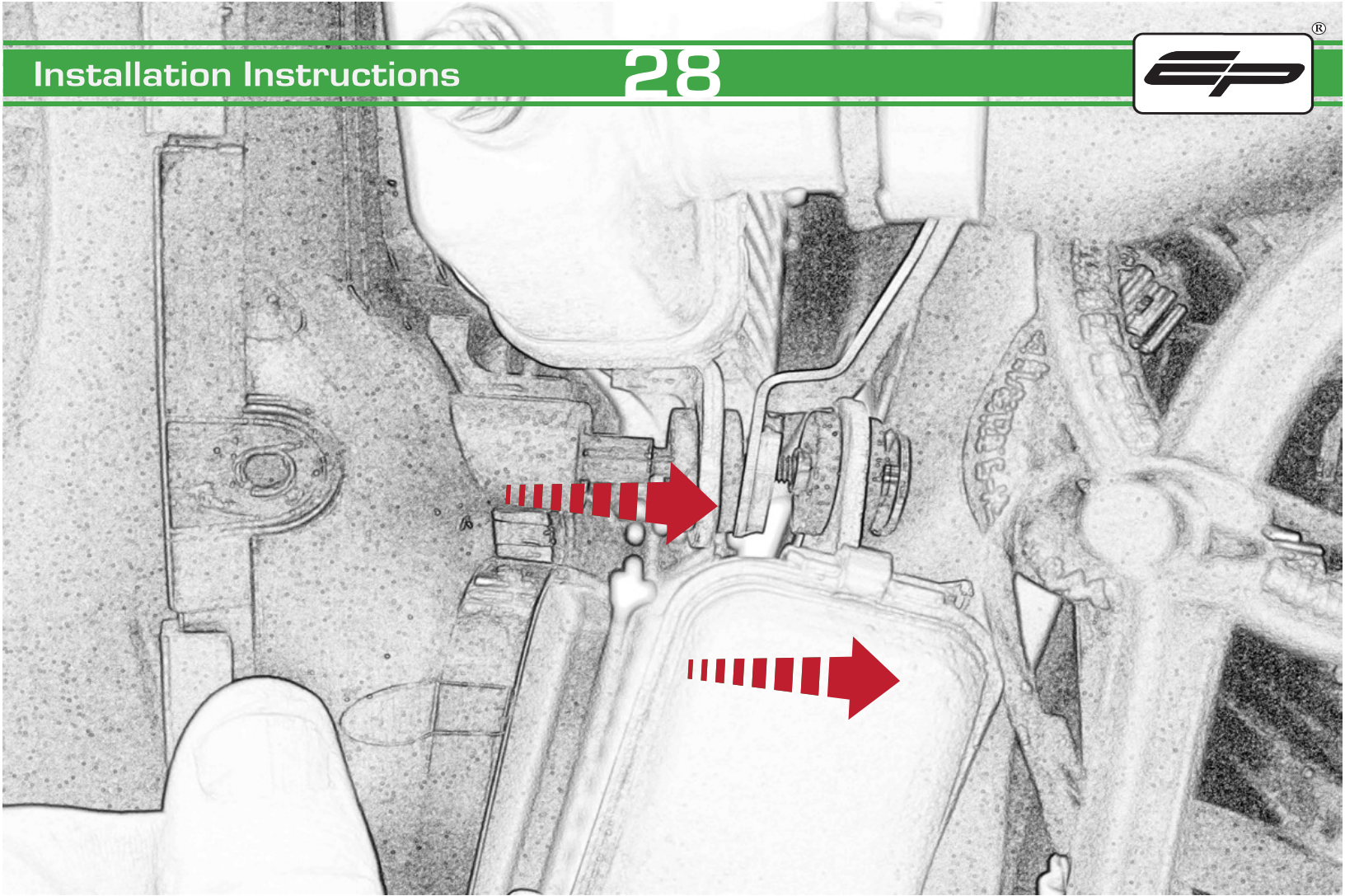



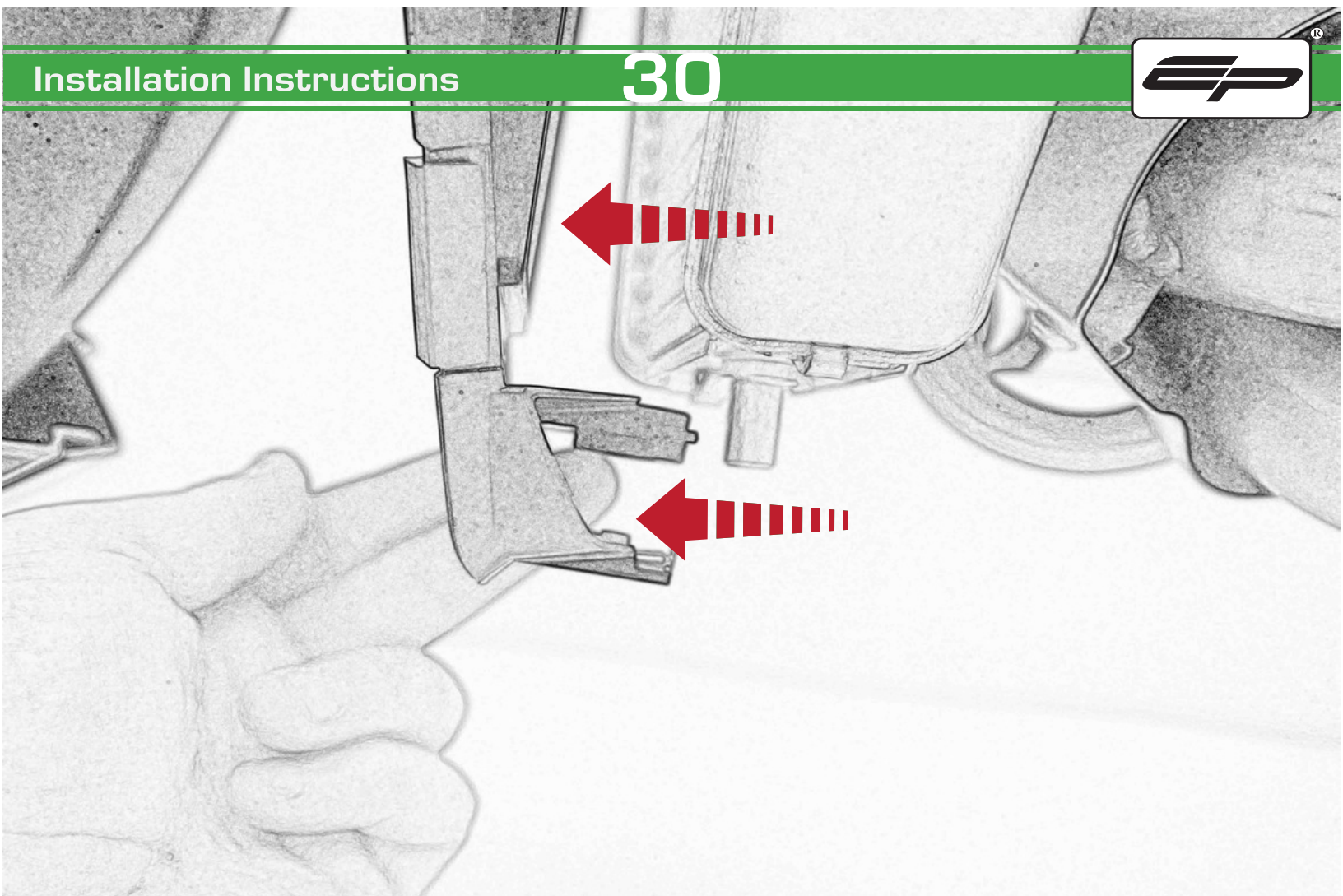

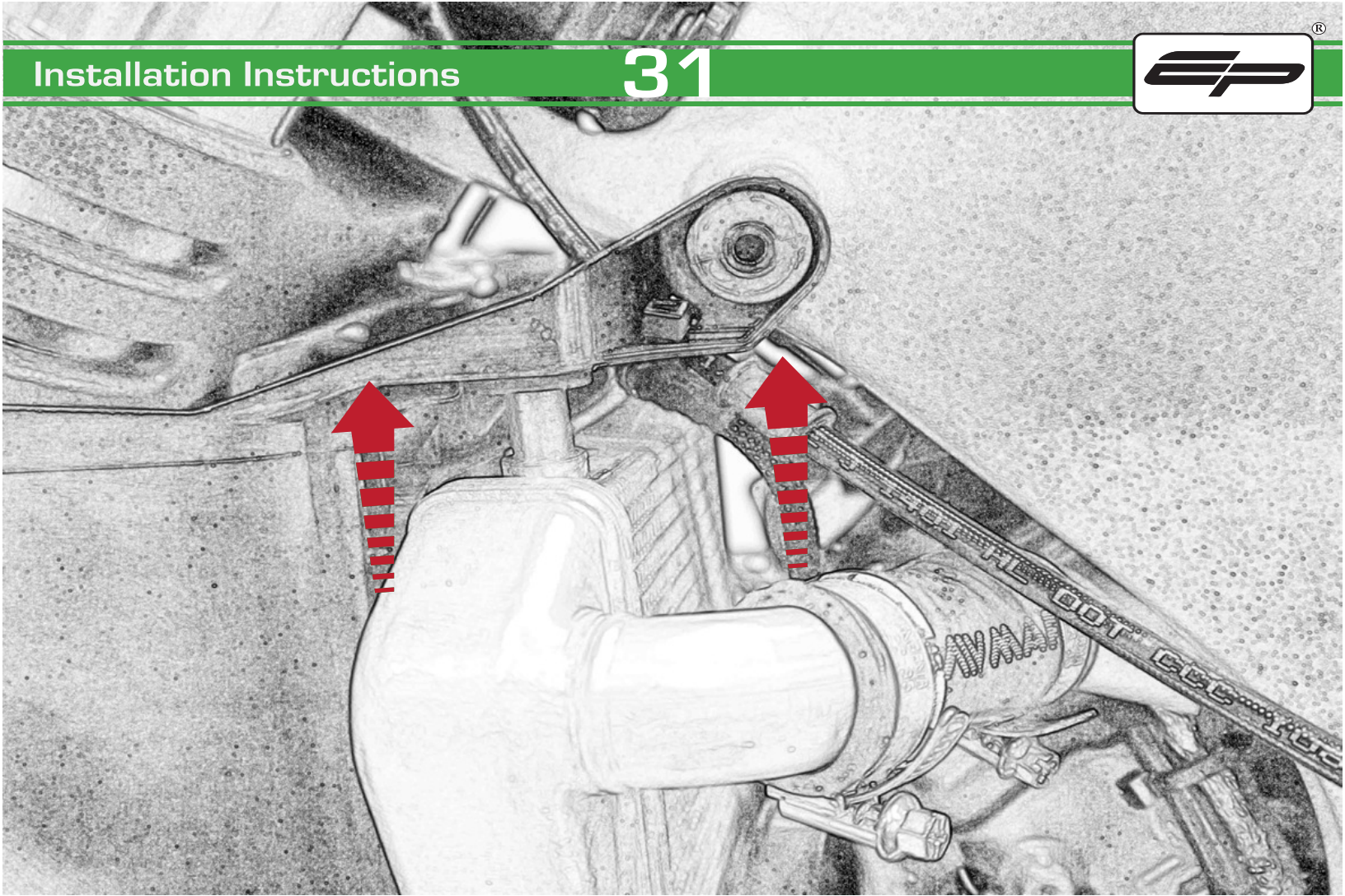

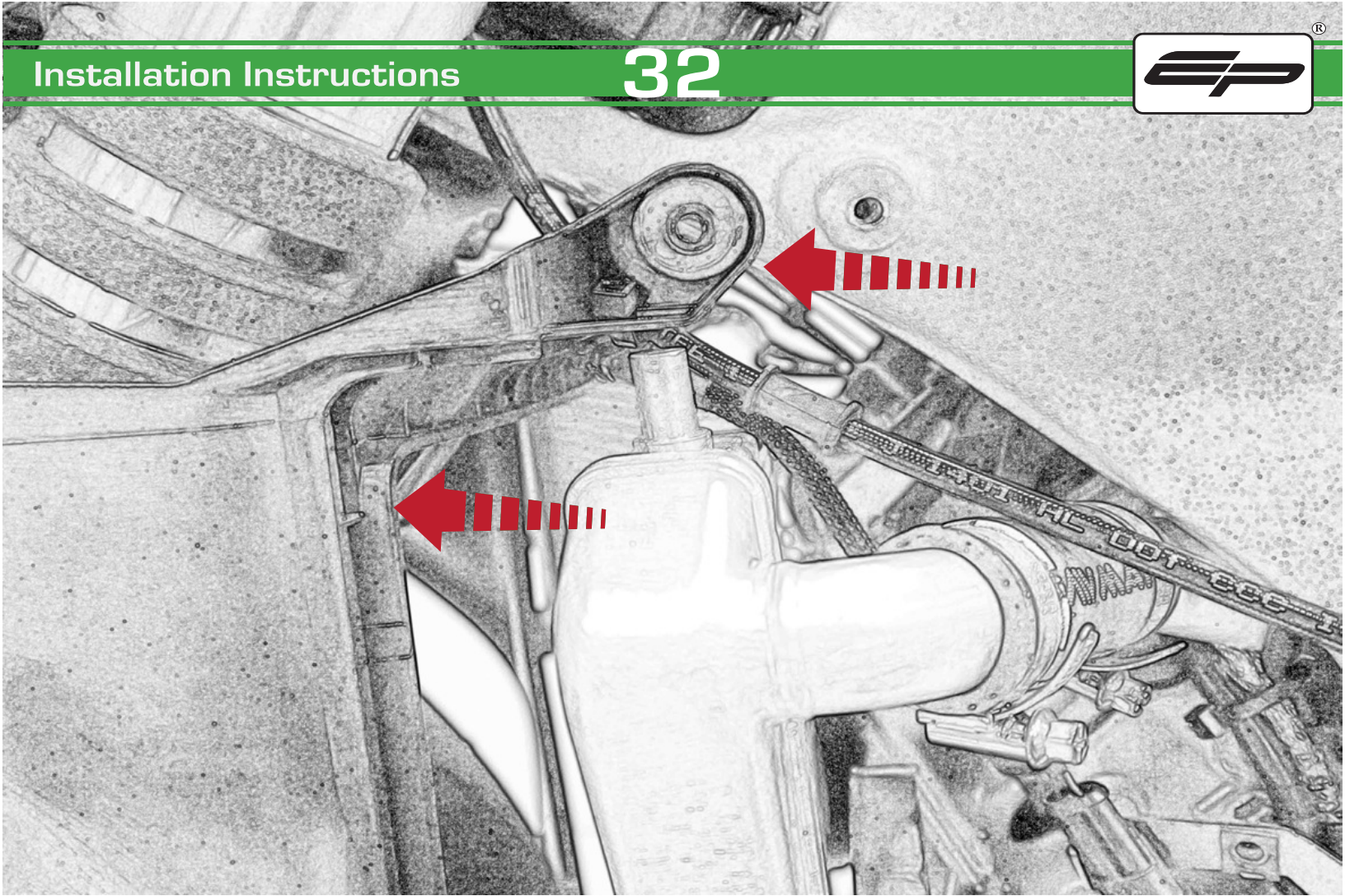

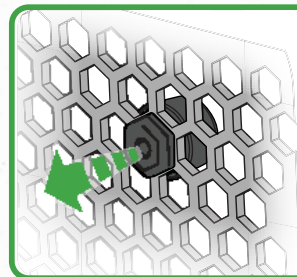
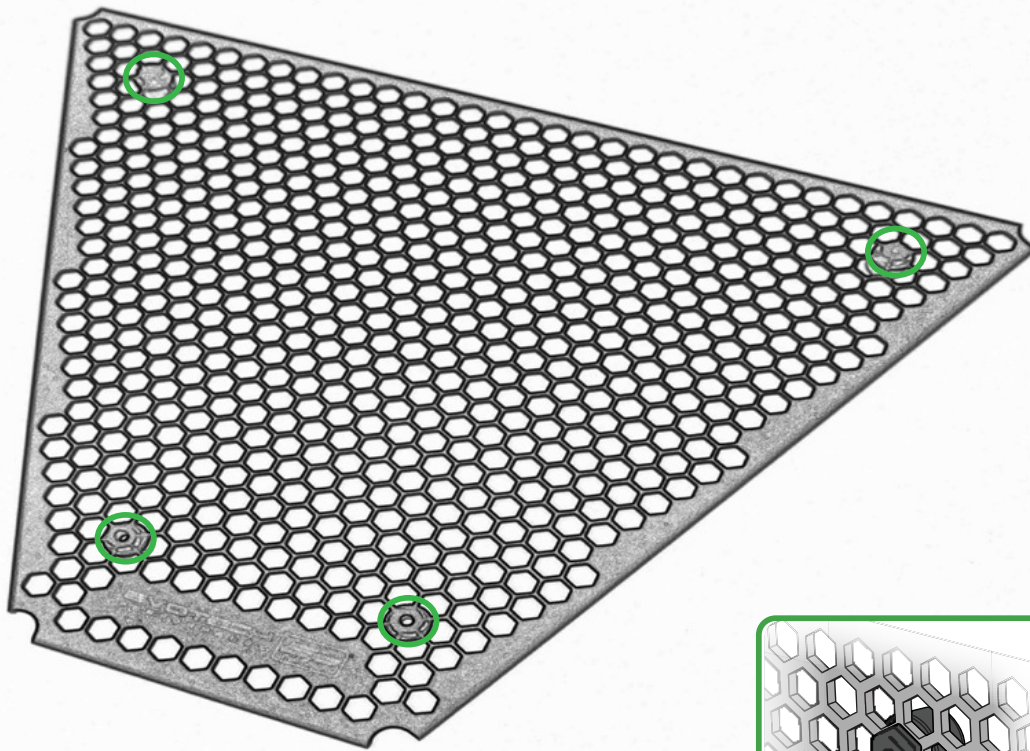

Locate round holes amongst hexagons.

Push Rubber Spacer through from the back of the guard so Hexagonal shape sits on the front face

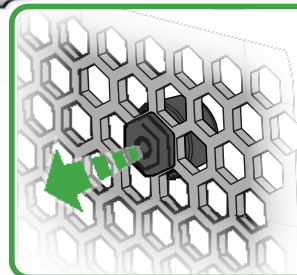
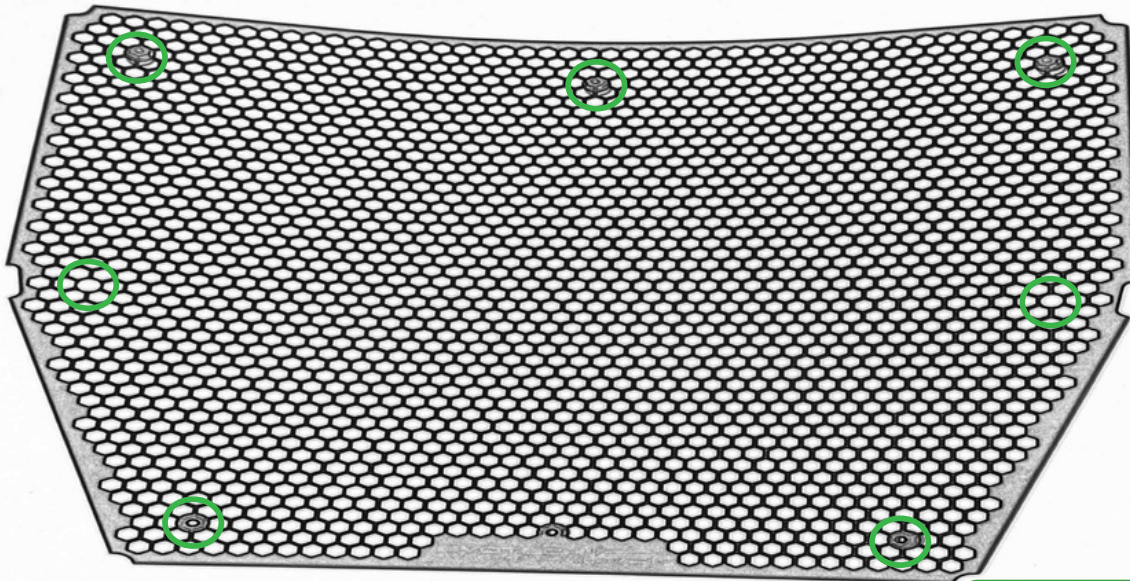

Locate round holes amongst hexagons.

Push Rubber Spacer through from the back of the guard so Hexagonal shape sits on the front face

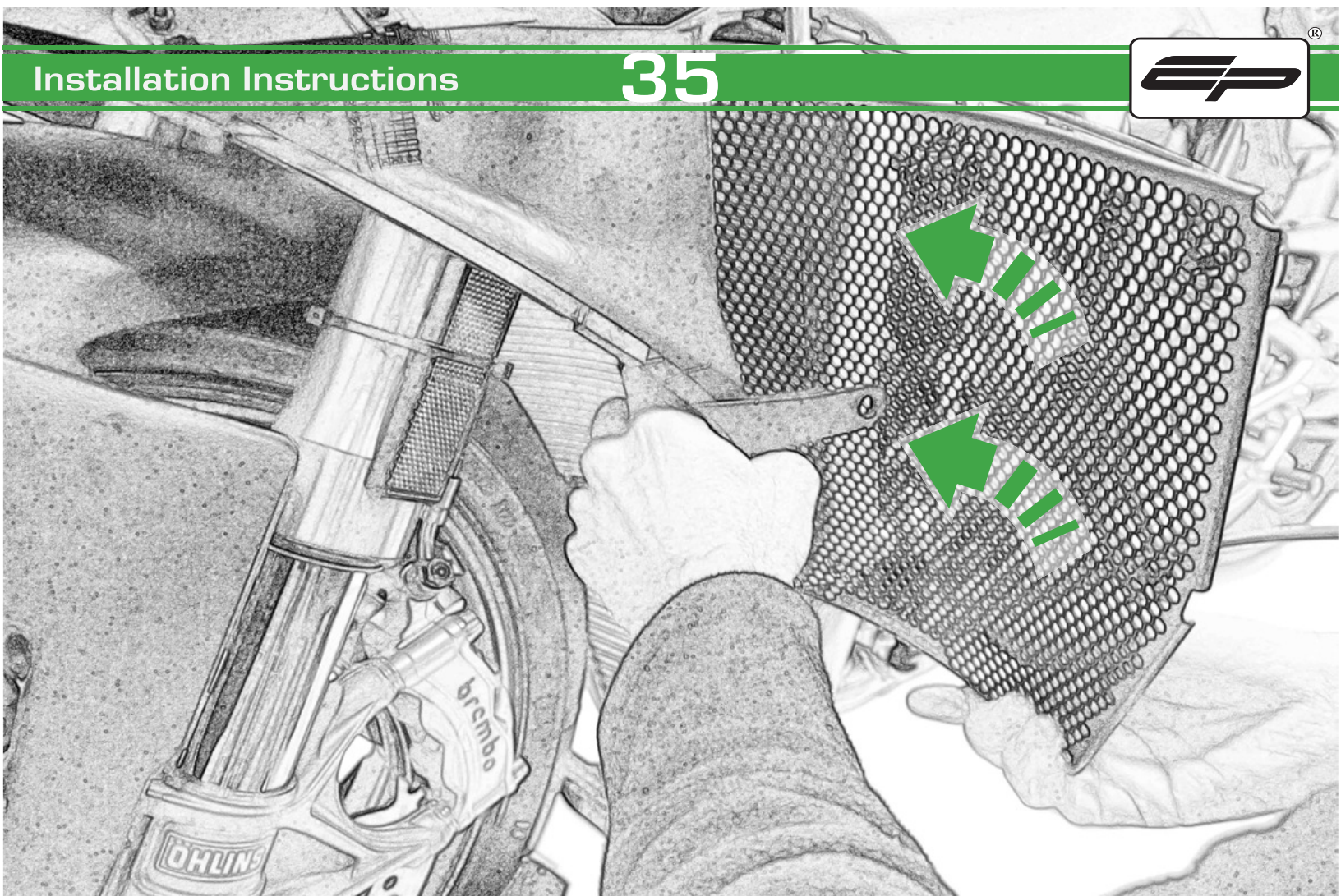

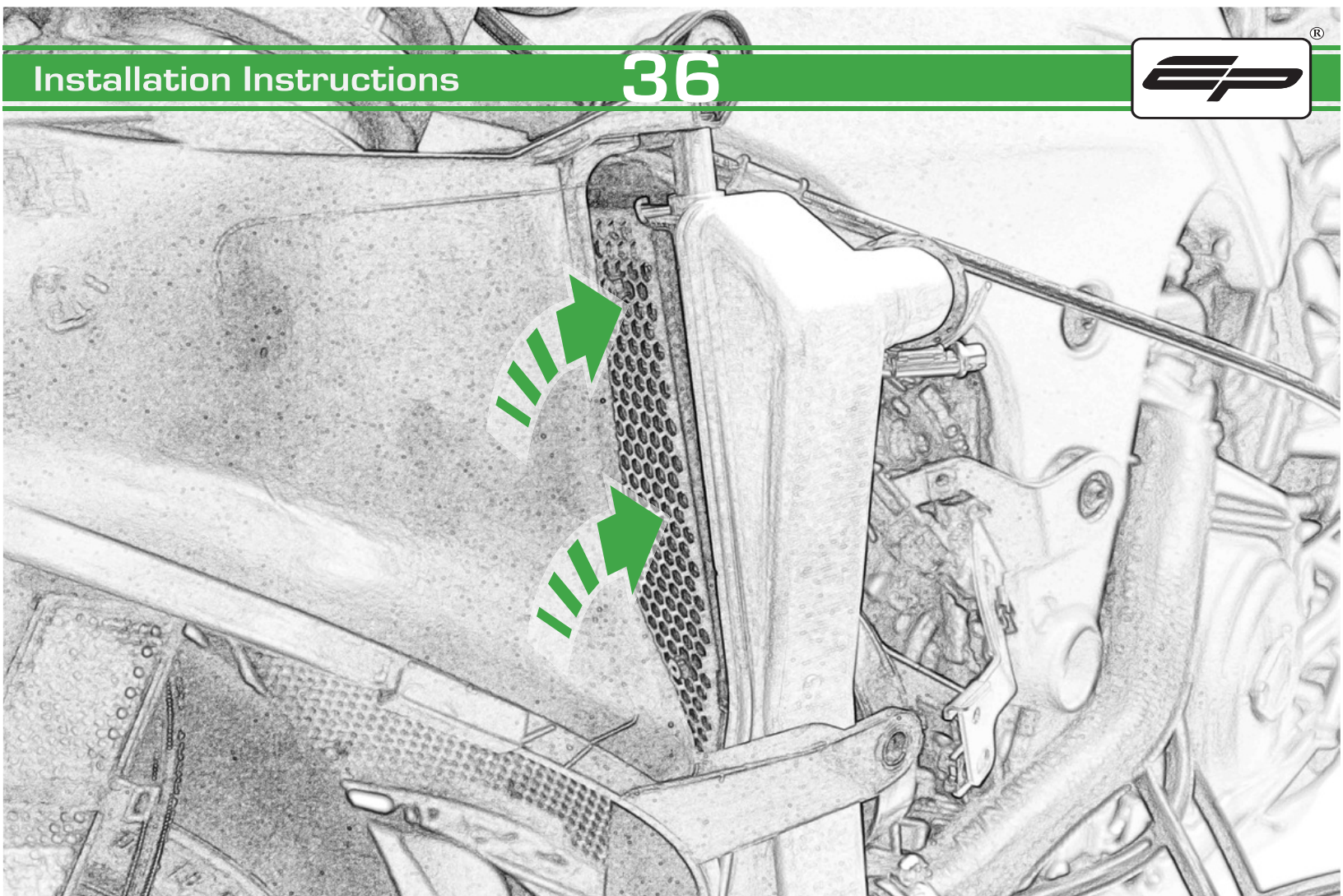

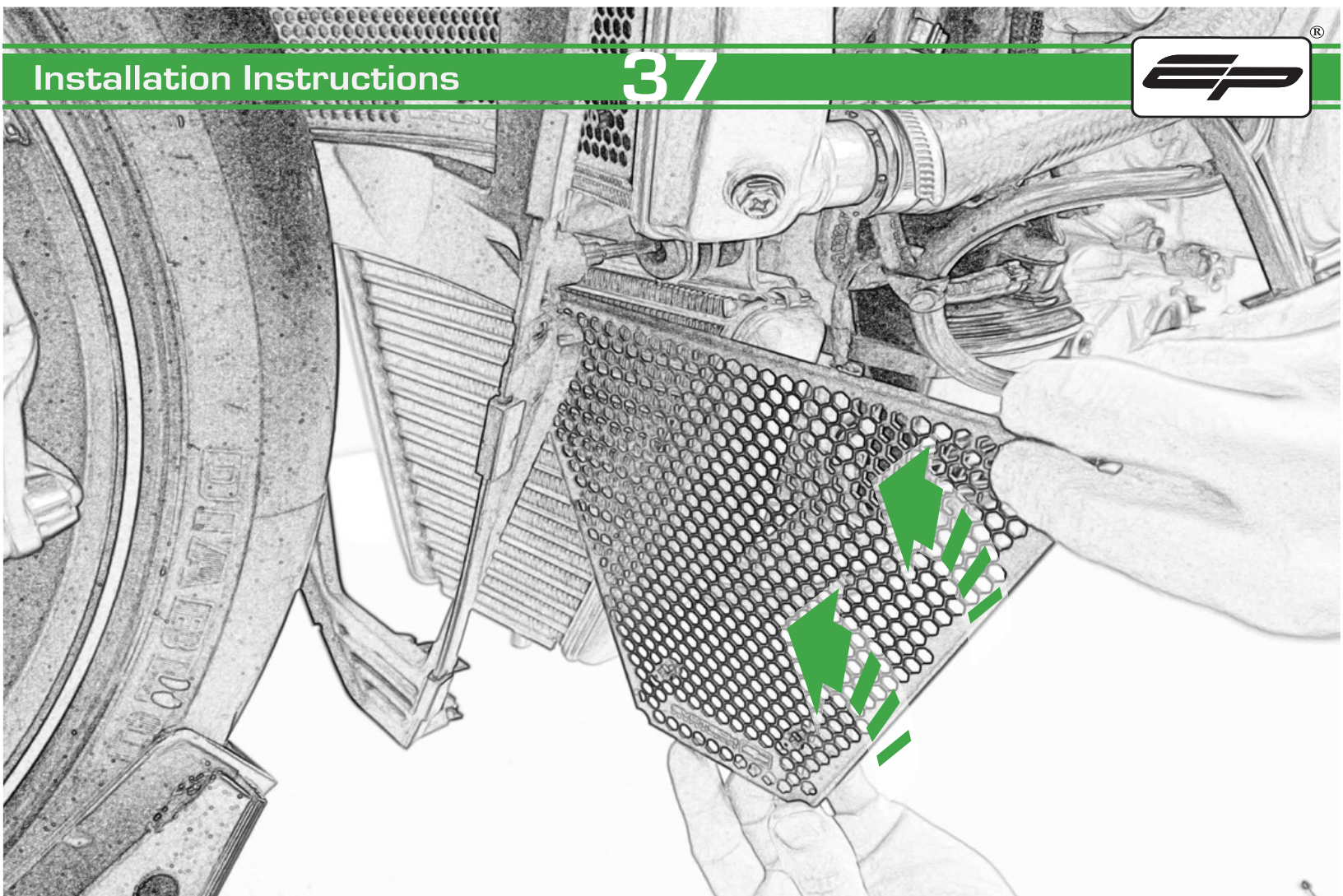

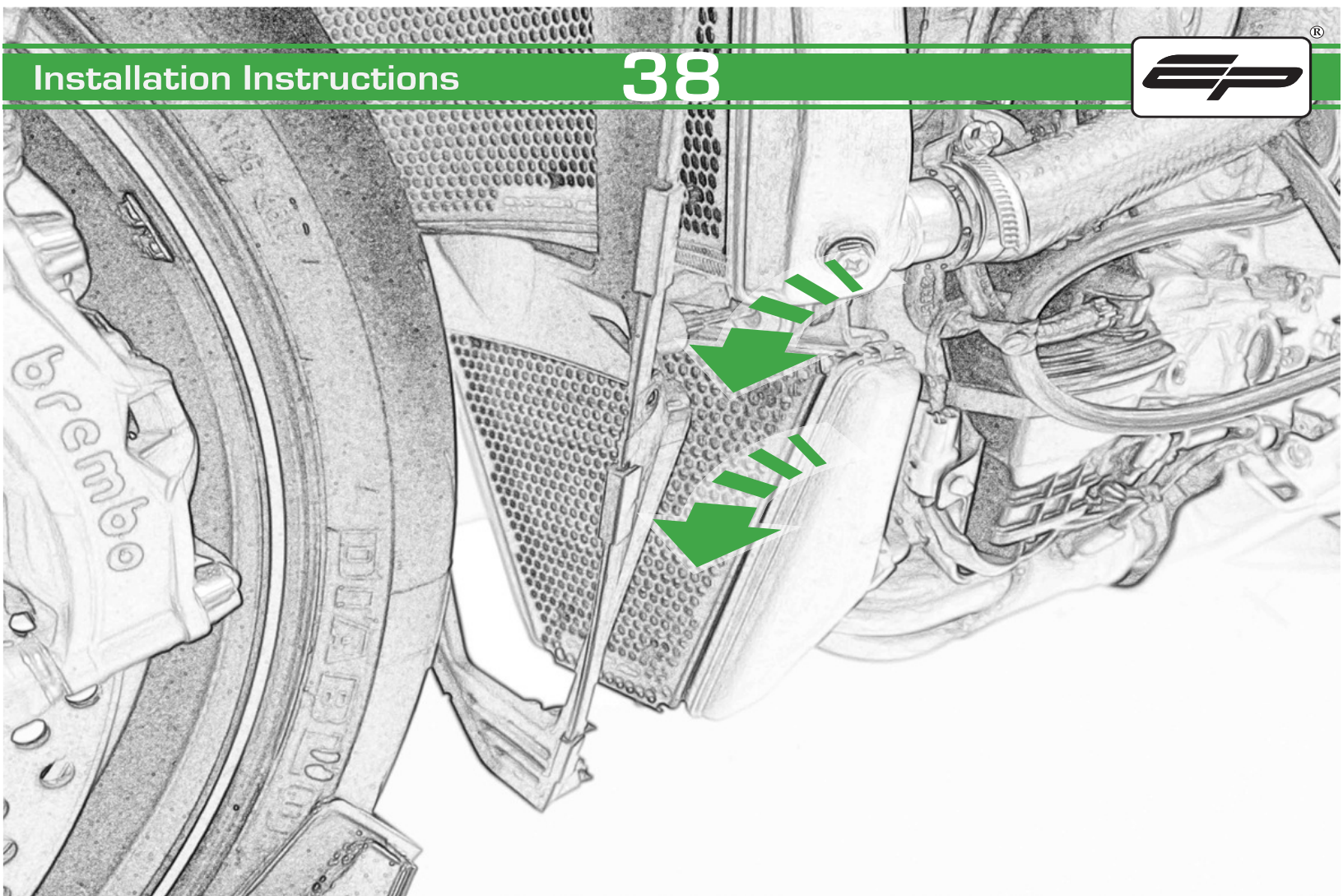

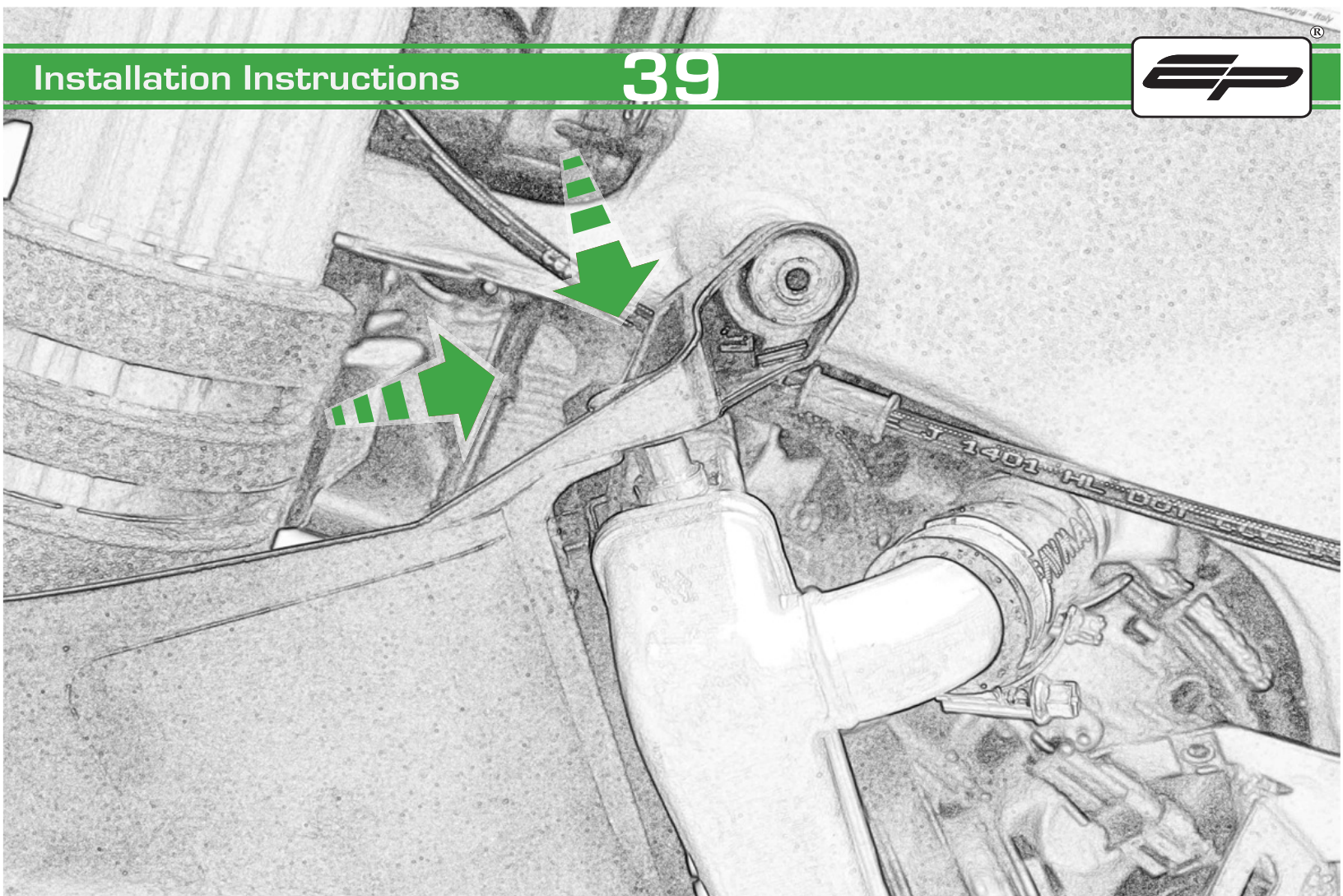

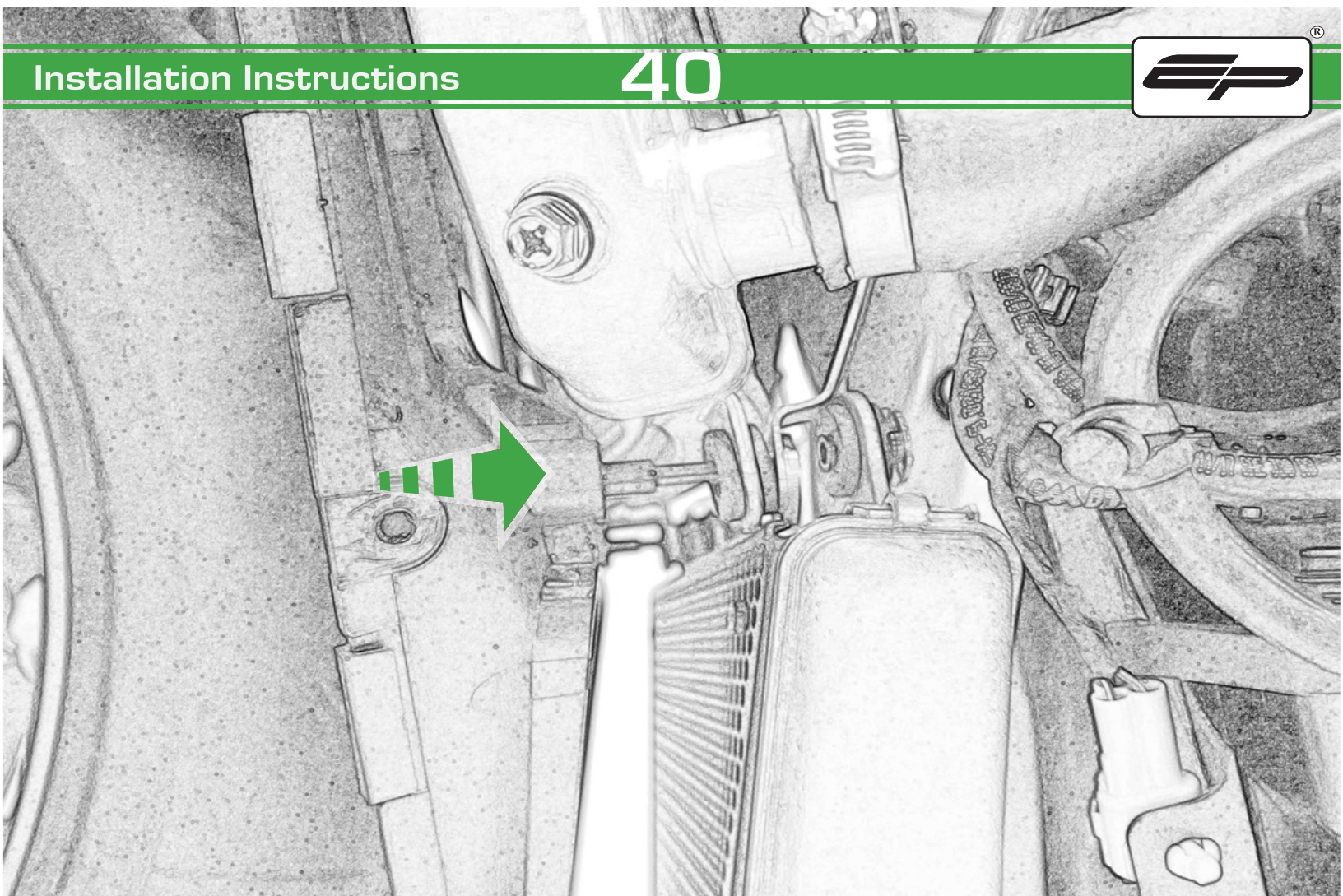

A large, light gray version of the EP logo is centered on the page. Overlaid on the left side of this logo is a green double arrow pointing to the left. To the right of the arrow, the text 'Reverse Stages' is written in a black, sans-serif font.

Reverse Stages

27 - 1



ESSENTIAL CHECKS

It is recommended that periodic inspections are made to ensure that dirt and debris have not become trapped between the guard and the radiator/oil cooler. Such dirt and debris would reduce the cooling efficiency of the radiator/oil cooler.

It is recommended that periodic inspections are made to ensure that all fixings are fully tightened.

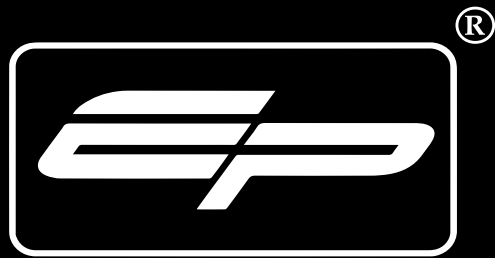

EVOTECH®
P E R F O R M A N C E

www.evotech-performance.com