



EVOTECH®
P E R F O R M A N C E

Installation Instructions



YAMAHA XSR700 TAIL TIDY

Product Reference - 13238

Kit Contents

- | | |
|--|--|
| A 1 x Main Tail Tidy | L 2 x M6 - 16 Black Button Screws |
| B 1 x Indicator Bracket | M 2 x M6 Nyloc Nuts |
| C 1 x Plastic Undertray | N 2 x M6 Black Washers |
| D 1 x Reflector and Bracket | O 2 x M5 Nyloc Nuts |
| E 1 x LED Light Unit (with nuts attached) | P 2 x M4 Nyloc Nuts |
| F 1 x Stainless Mounting Boss | Q 3 x Undertray Tabs |
| G 1 x Wiring Connector | R 3 x M4 - 8 Black Button Screws |
| H 1 x M5 - 16 Black Button Screw | S 5 x M4 Black Washers |
| I 1 x M5 Black Washer | T 5 x Cable Ties |
| J 2 x Plastic Spacers | U 8 x M5 - 10 Black Button Screws |
| K 2 x Plastic Nuts and Screws | V 2 x M6 - 25 Black Button Screws |

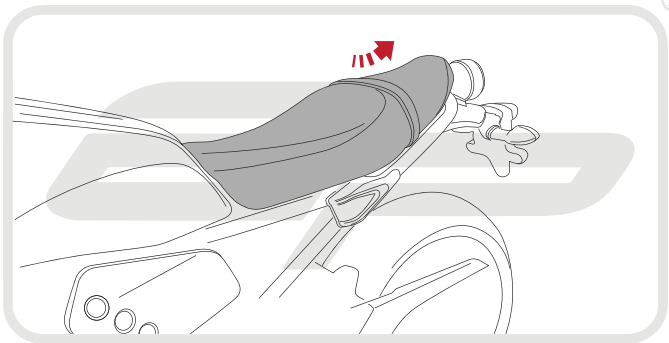

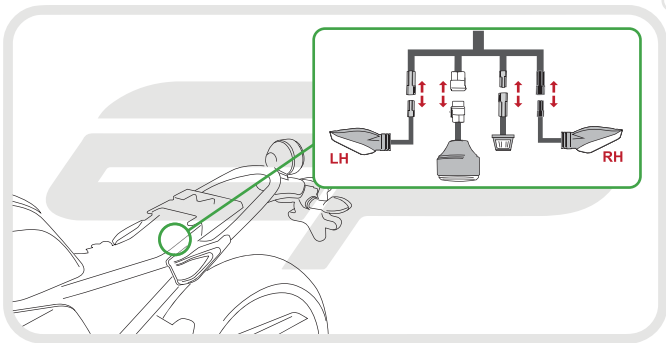

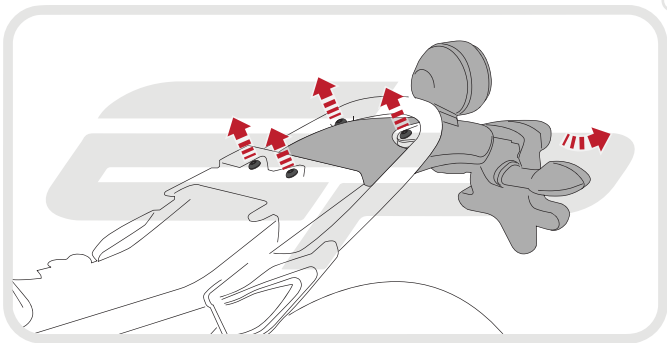

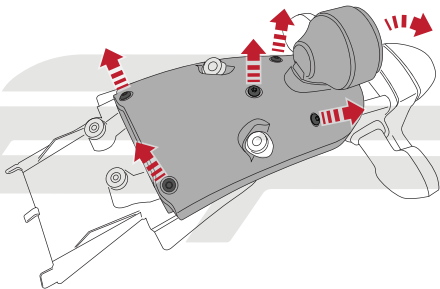

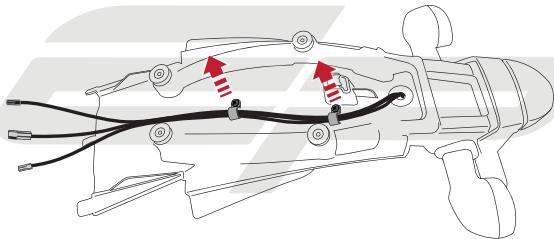

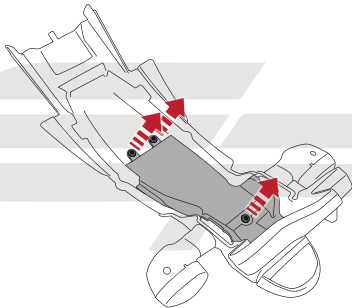

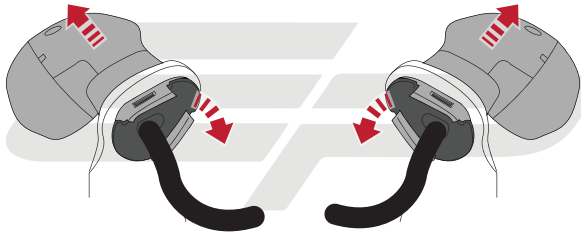



Refit indicators ensuring
drain holes are in the
correct orientation

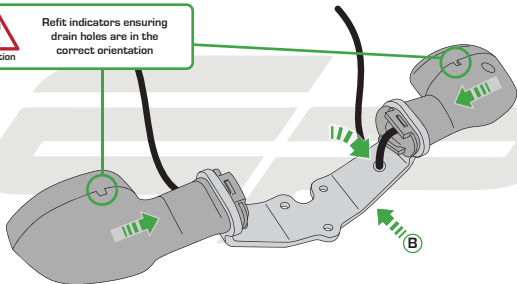

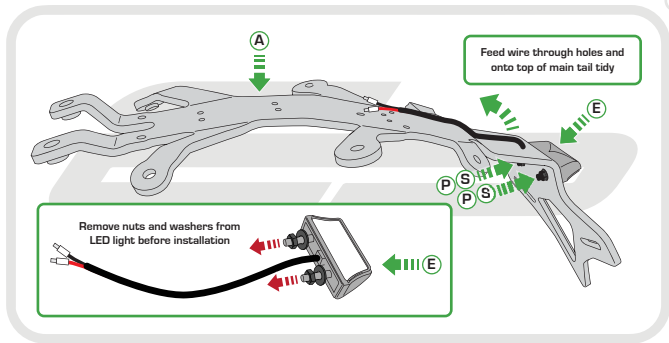



Caution

Follow this stage if bike has paniers fitted.
If NOT running paniers please move
on to the next stage

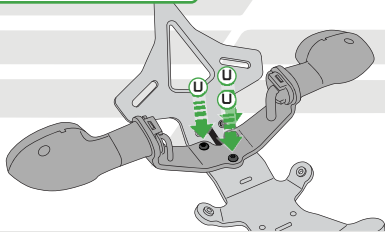



Caution

Follow this stage if bike has panniers fitted.
If NOT running panniers please move
on to the next stage

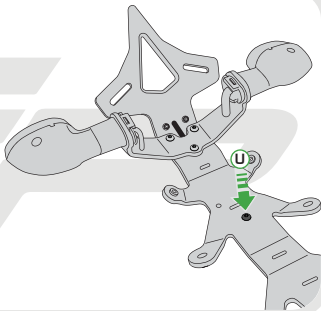
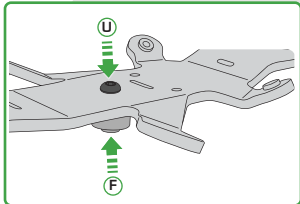



Follow this stage if **NOT** running paniers
or wish indicators to be mounted
further up underneath the seat



Leave cable tie open
at this stage

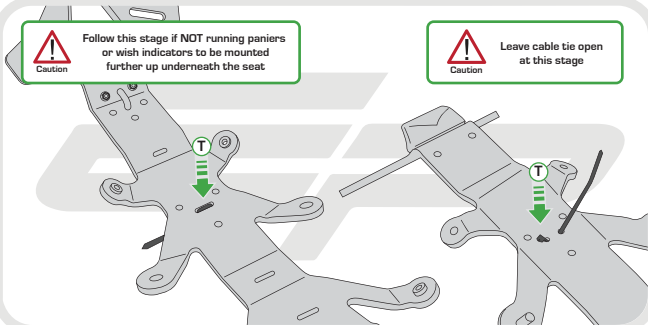



Caution

Follow this stage if **NOT** running paniers
or wish indicators to be mounted
further up underneath the seat

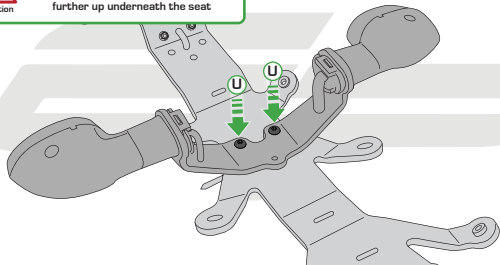



Caution

Follow this stage if **NOT** running paniers
or wish indicators to be mounted
further up underneath the seat

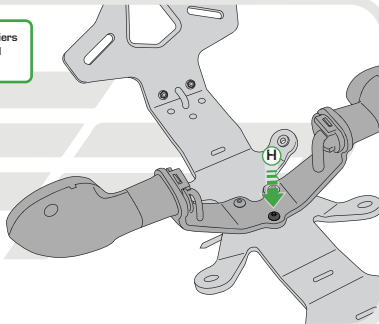
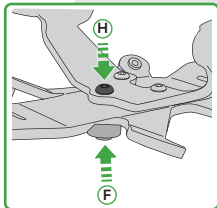

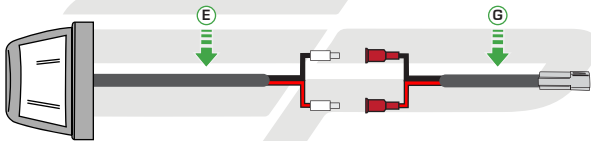

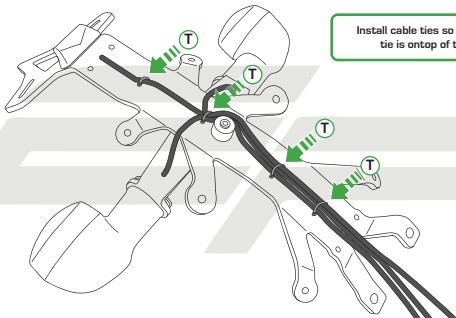

Install cable ties so the head of the tie is on top of the tail tidy

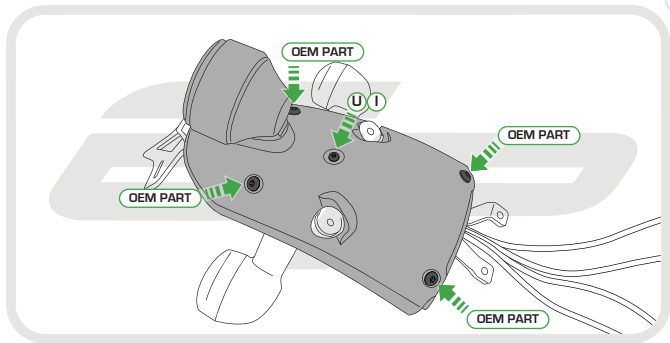

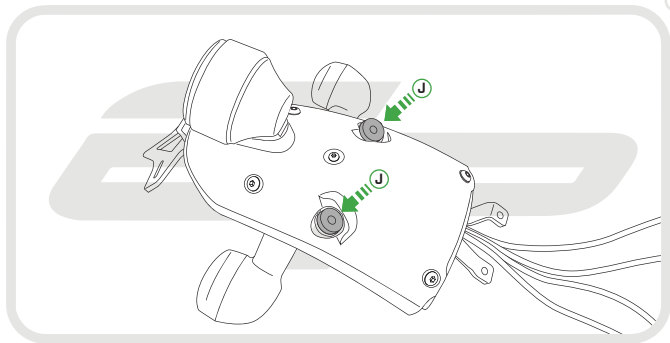

EVOTECH[®]
P E R F O R M A N C E

Feed wires along original routing
and into under seat area

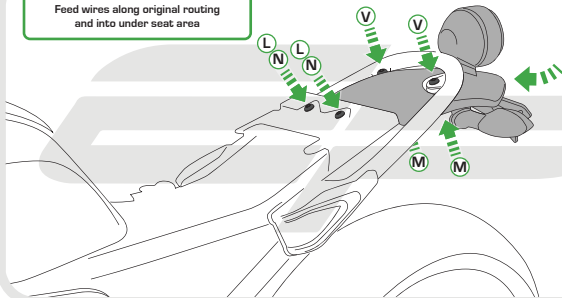

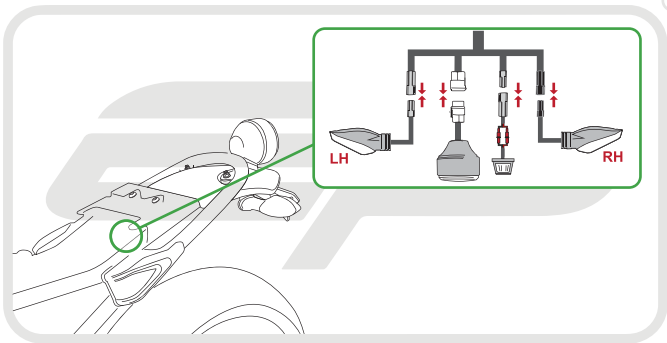

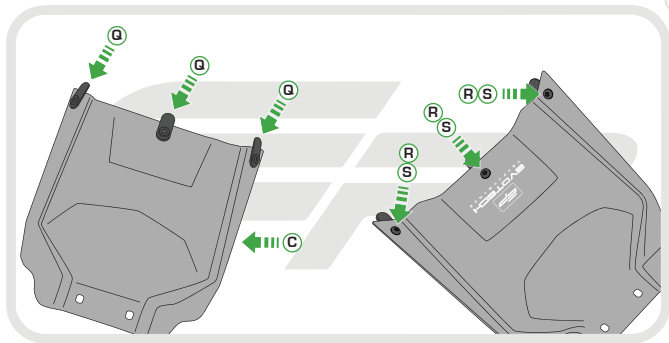

Ensure tabs installed in Stage 21
tuck in behind original undertray

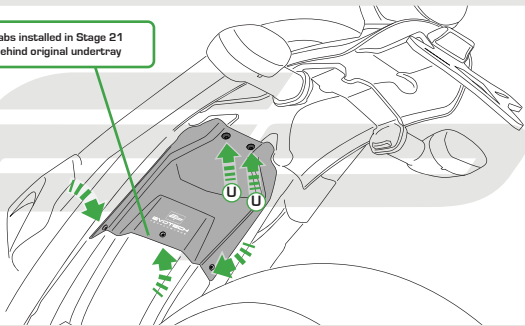

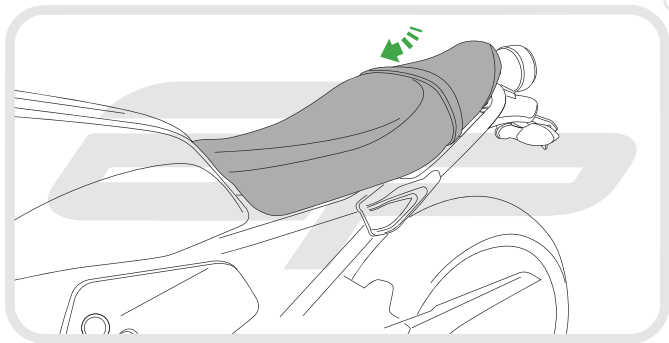

Reflector Bracket Installation

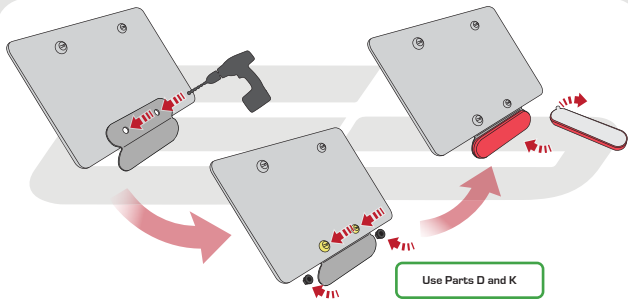

EVOTECH[®]
P E R F O R M A N C E



ESSENTIAL CHECKS



After installation of your tail tidy ensure that the licence plate does not contact the rear tyre when suspension is fully compressed.

Ensure all electrics including indicators, tail light, brake light and licence plate light lights are working correctly before riding the motorcycle.

It is recommended that periodic inspections are made to ensure that all fixings are fully tightend.



EVOTECH®
P E R F O R M A N C E

www.evotech-performance.com