

GC3-T

User Guide



SwellPro

Visit www.swellpro.com for the latest version of this manual and firmware updates for your drone and accessories.

v Beta 1.0 – Oct. 2021

NOTICE

THIS IS THE BETA VERSION OF THE USER GUIDE. SOME PARTS OF THE USER GUIDE MIGHT BE CHANGING THROUGH THE PRODUCT IMPROVEMENT. PLEASE ALWAYS CHECK AND COMPARE THE VERSION NUMBER TO SEE IF THERE IS A LATEST VERSION OF THIS USER GUIDE ON OUR WEBSITE.



<https://www.swellpro.com/splash-drone-4.html#download>

Thank You

Thank you for purchasing the GC3-T waterproof 3-axis Gimbal Thermal Camera. We have designed and manufactured the GC3-T to the highest quality standards.

Like any precision equipment, long-life and trouble-free operation rely on proper care and maintenance. With proper care and maintenance, you should enjoy your product for many years. It is important to familiarize yourself with the features of this unique product by carefully studying this manual.

Visit www.SwellPro.com for the latest manuals, firmware, and tips. Refer to the Version Information section at the end of this manual, which details additions and corrections to this manual.

Using this Manual

This document is designed to be printed or viewed on a computer or mobile device. If used electronically, you can search directly for terms like "Propeller" to find references. Additionally, you can click on any topic in the Table of Contents to navigate directly to that topic.

FAQ

The user guide is the best companion while using the product. For the specific problem using the product, the FAQ can be another great resource for you to look at. Go to the SwellPro website, look for support >product support > the product > FAQ to find the FAQ page. <https://www.swellpro.com/news/product-support.html>



Video Tutorials

Visit and subscribe to the SwellPro YouTube channel for tutorial videos and product



information. Scan this QR code with your camera phone to go to our channel.

Social Media

Join our SwellPro Facebook page to meet other people who share their adventures with SwellPro. www.facebook.com/SwellPro/



Register Product Warranty

Please register your product as soon as possible to ensure warranty coverage. <https://www.SwellPro.com/info/register.html>

Download the SDFly App

For Apple devices, download the SDFly app on the AppStore. For Android devices, download the SDFly app on the Google Play Store or scan the QR code to download and install the app.

IOS



Android



www.swellpro.com

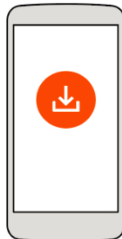

SDFly



Content

NOTICE	2
Thank You	3
Using this Manual	3
FAQ	3
Video Tutorials	3
Social Media	4
Register Product Warranty	4
Download the SDFly App	4
Content	5
Precaution	7
Product Overview	8
In the Box	9
Product Diagram	10
Installation	11
Install the Gimbal	11
Install the SD Card	11
Camera Status Indicator	12
Control	13
Gimbal Control	13
Gimbal Button	13
Camera Control	14
Calibration	14
SDFly App	16
Main Interface	16
Thermal Camera Setting	18
Appendix	21

Specification	21
Version Information	22

Precaution



READ AND UNDERSTAND ALL PRECAUTION INFORMATION BEFORE USING THIS PRODUCT. Failure to follow these safety instructions may result in permanent damage to the product.

DO NOT point the thermal camera to strong energy sources, such as sun, laser beam, or lava. The observed object's temperature should not exceed 800°C, as the high energy radiation is harmful to the thermal camera.

DO NOT place the camera near any heat sources, such as fire, engines, heating, or inside the vehicle under prolonged sunlight exposure.

The ideal working temperature is -20°C ~ 50°C.

DO NOT touch thermal camera lens with your fingers or any other object, as oil or other substance covering the lens leads to blurred images and inaccurate temperature detection.

DO NOT use alcohol or alkaline detergent to clean the camera lens, as it can erode the surface and coating on the lens. Instead, use a clean, dry, soft cloth to clean the lens.

DO NOT frequently power on/off the camera, as it might shorten the product lifespan. Wait for at least 1 min in between the power on/off.

DO NOT insert or unplug the microSD when the camera is on, as it might cause files loss or hardware issues.

ENSURE to press the rubber microSD card cover firmly in place to prevent water ingress in use.

DO NOT disassemble the camera. If you have any issues with the camera, contact SwellPro Support.

Product Overview

GC3-T Waterproof 3-axis Gimbal Thermal Camera features both a high resolution thermal infrared camera and a full HD low-light camera with a dimmable LED flashlight, which can provide both infrared and visible light imaging simultaneously and allow for a quick switch between the two.

The thermal infrared camera features high resolution (640 x 512), high sensitivity ($\leq 50\text{mk}@f/1.0$), wide range (-20°C to 150°C) infrared thermal imaging. Powerful enough for missions ranging from search & rescue, security detection, precision agriculture to various industrial inspections, such as routine power line inspection, roofing and solar panels maintenance, bridge defect detection, etc.

The low-light camera can capture full HD imaging in the dark environment when the regular camera cannot return any images. When operating in complete darkness, the dimmable LED flashlight still gives you the confidence to maintain the vision. With the low light camera, whenever you find the object of interest using the infrared thermal camera, you can always switch back to give a visual confirm of the object.

With the SwellPro waterproofing technology and the compatibility with the powerful SplashDrone 4 flight platform, you will get excellent aerial thermal imaging in any harsh weather conditions.

In the Box

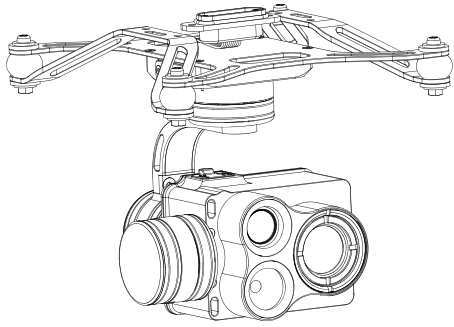

Gimbal Thermal Camera x1

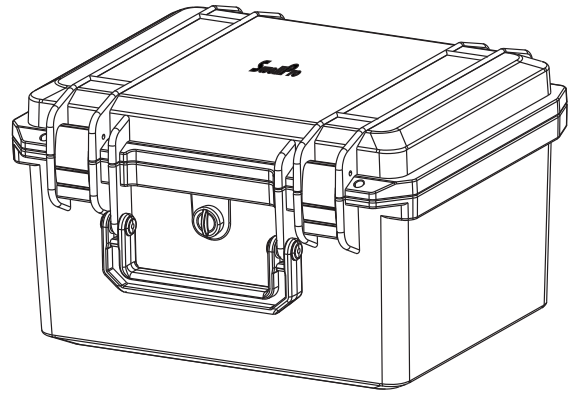

Storage Case x1

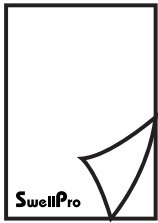

User Guide x1

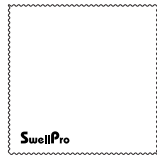

Lens Cleaning Cloth x1



Accessories Bag x1



microSD Card x1

Product Diagram

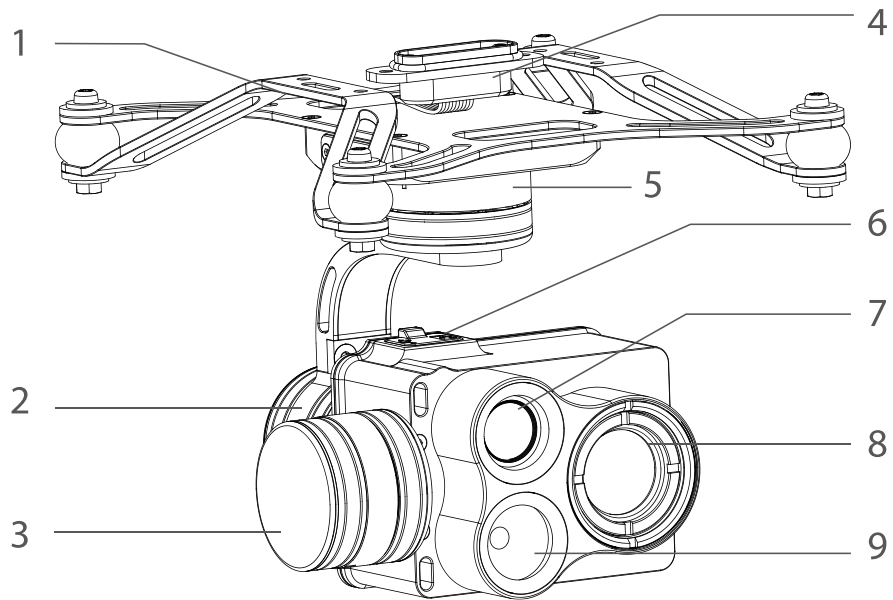

- 1. Gimbal Mount
- 2. Roll Motor
- 3. Tilt Motor

- 4. Gimbal Connector
- 5. Pan Motor
- 6. microSD Card Slot
- 7. Low light Camera
- 8. Infrared Thermal Camera
- 9. Dimmable LED Flashlight

Installation

Install the Gimbal

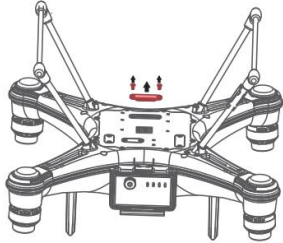

1. Unscrew and take off the gimbal port cover plate using a hex screwdriver. (Equipped with SplashDrone 4)



2. Plug the gimbal connector into the drone's gimbal port and screw it in place with a screwdriver.

! Make sure the rubber ring is attached to the gimbal connector before you screw the connector.

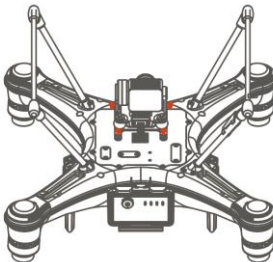

3. Align the holes on the gimbal mount to the bottom of the drone, screw in to mount the gimbal. Make sure the camera is pointing to the front of the drone.

Install the SD Card

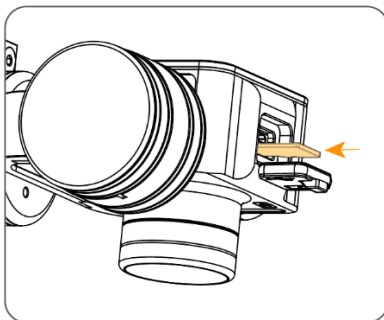

1. Open the rubber sealing on the top of the camera, insert the microSD card in the correct direction, press the microSD card. The "click" sound indicates that the installation is in place.
2. After installing the microSD card, plug the rubber seal back.





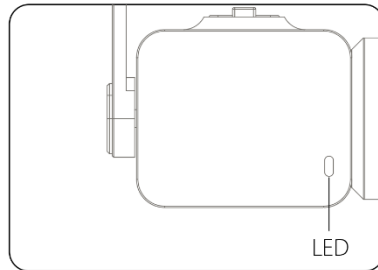

! Make sure the rubber sealing is firmly in place to ensure waterproofing.

- The GC3-T supports microSD cards with a maximum capacity of 128GB. Since the camera requires fast reading and writing of high-stream video data, please use microSD cards with Class 10 or UHS-1 or above to ensure proper functioning.
- Do not plug or unplug the microSD card during use, as files may be damaged or lost.
- Once you finish recording, stop recording and save the file. If you turn off the power directly before saving the files, the recording file might be damaged.

Camera Status Indicator

There is a camera status indicator on the back of the camera to indicate the camera's working status. It flashes green or red.



LED		
	Solid Green	Ready to shoot
	Flashing Green	No SD card
	Flashing Red Once	Taking photo
	Flashing Red	Video recording
 Solid	 Flashing	

Control

Gimbal Control

Remote controller

Description

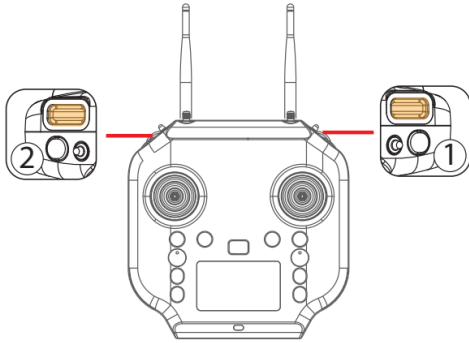

Tilt ①: Roll the right gimbal control as shown to turn the gimbal up or down from 0° to -90°.

Dimmable LED light control ②: Roll the left gimbal control to adjust the brightness of the dimmable LED light. (Dimmable LED light works the best when the aircraft is 15 meters away from the subject.)

Gimbal Button

There are two gimbal modes: Follow mode and Lock mode. The default mode is Follow mode.

Follow mode keeps the gimbal direction to the head of the drone.

Lock mode locks the gimbal position to a fixed angle instead of following the drone's direction.

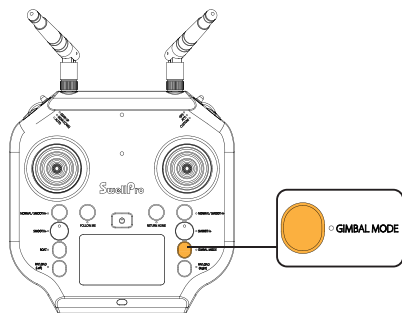

Press the GIMBAL MODE button once to restore the central position.

Fast press the GIMBAL MODE button 3 times to switch gimbal modes.

Camera Control

Remote controller

Description

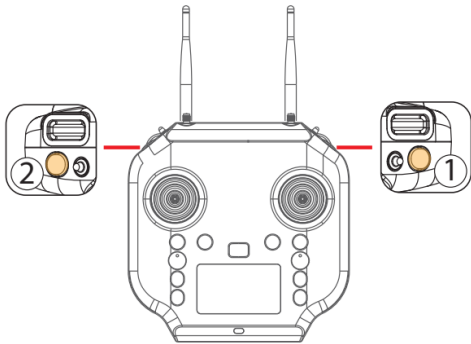

Photo①: press once to take a picture.

Video②: press once to start recording, press again to stop recording and save the file.

💡 When taking photos or videos, the camera will take both the thermal imaging files and the RGB files and store them together in the memory card.

Calibration

If there are any abnormal movements being observed or the camera is not level, you can recalibrate the gimbal camera to solve the problem.

Gimbal camera calibration is performed together with the aircraft gyroscope calibration. To calibrate the gimbal camera, you need to proceed with aircraft gyroscope calibration.

To calibrate the gimbal camera:

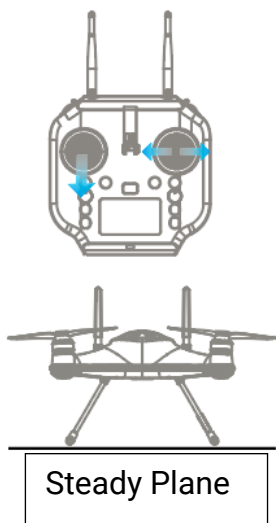

1. Place the drone on a level surface, power on the remote controller, then the drone. Wait for the aircraft to connect to the remote controller.

2. Hold the left joystick down to its lowest position, then quickly move the right joystick left to right, back and forth, until the front and rear status indicators flash alternately, or the remote controller screen prompts "WARNING aircraft Initializing, Please Wait." The drone will now perform gyroscope calibration. Now release the joysticks. This process will be completed in 20 seconds. Do not move the drone during this process.

3. When the front status indicators fast-flashing red, and the rear status indicators turn solid green, or "WARNING Aircraft Initializing, Please Wait" prompt disappears, power off and

restart the drone. Gyroscope calibration is complete.

⚠ Do not calibrate the gimbal camera on a boat or other moving platforms.

SDFly App

Main Interface

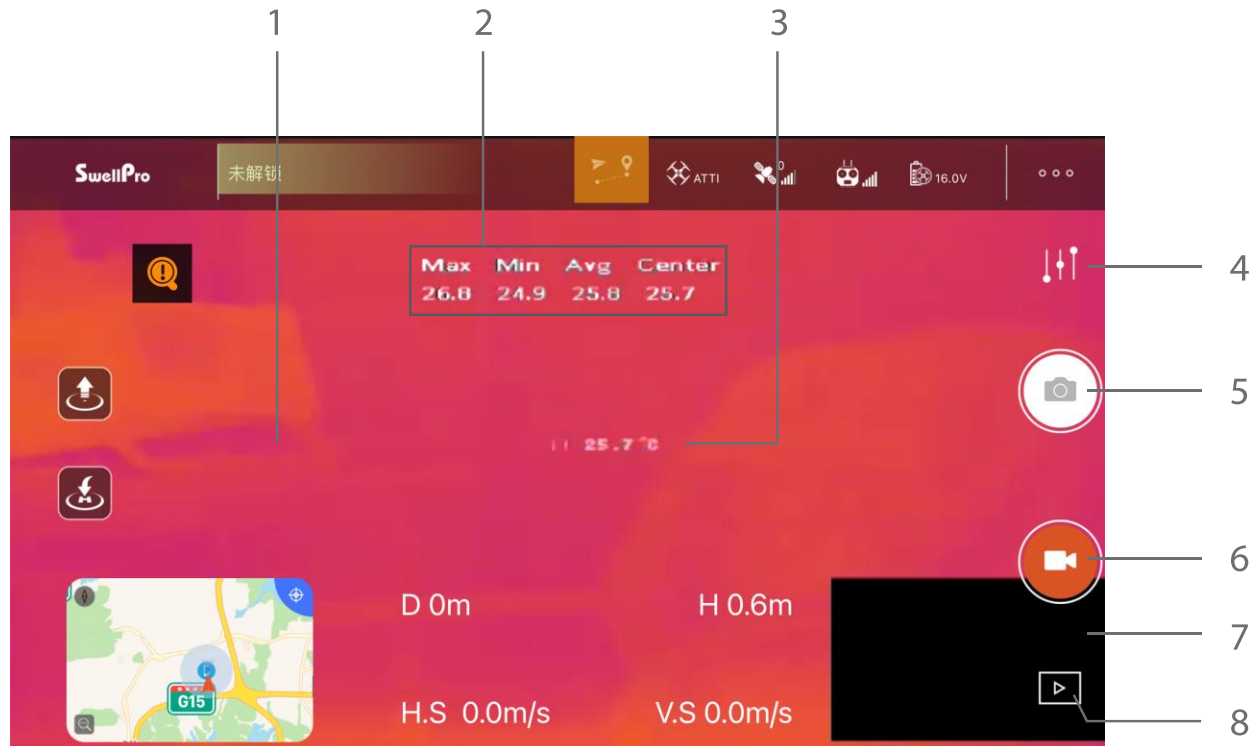

1. Main Camera View

Main Camera View displaces the Livestream of the camera view. Tap the Camera View Thumbnail on the bottom right corner to switch the Main Camera View between the thermal camera and the low-light camera.

2. Temperature OSD

Temperature OSD contains the **Max, Min, Avg, Center** temperature information detects by the thermal camera.

Max: the maximum temperature that appears on the image.

Min: the minimum temperature that appears on the image.

Avg: average temperature across the whole image.

Center: the temperature at the center of the image.

3. Center Temperature

The temperature at the center of the image, same as the Center on the Temperature OSD.

4. Camera Setting

Change camera settings and adjust camera parameters for both the thermal camera and low-light camera.

5. Photo Taking Button

Tap to take photos. Both the thermal photo and RGB photo (from the low-light camera) are going to take simultaneously.

6. Video Record Button

Tap to record video, tap again to stop and save the video. Both the thermal video and RGB video (from the low-light camera) are going to save simultaneously.

7. Camera View Thumbnail

Camera View Thumbnail displaces the alternative camera view. Tap the thumbnail to change the main camera view between thermal camera view and low-light camera view.

8. Gallery

Gallery is where you can find the photos/videos been taken by the camera on the microSD card.

Thermal Camera Setting

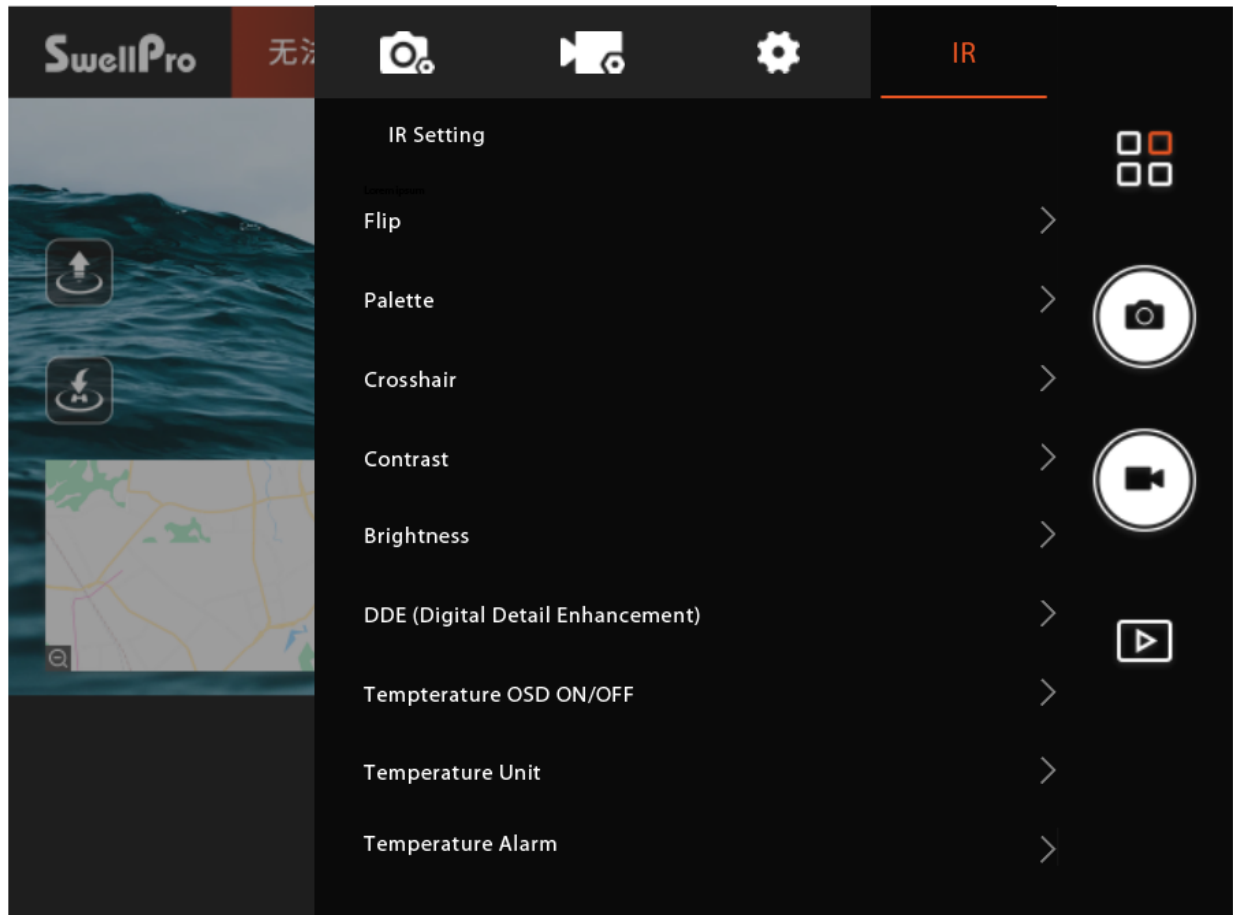

Flip

Flip the image vertically or horizontally.

Palette

Select different color palettes in various conditions to better visualize the infrared thermal imaging.

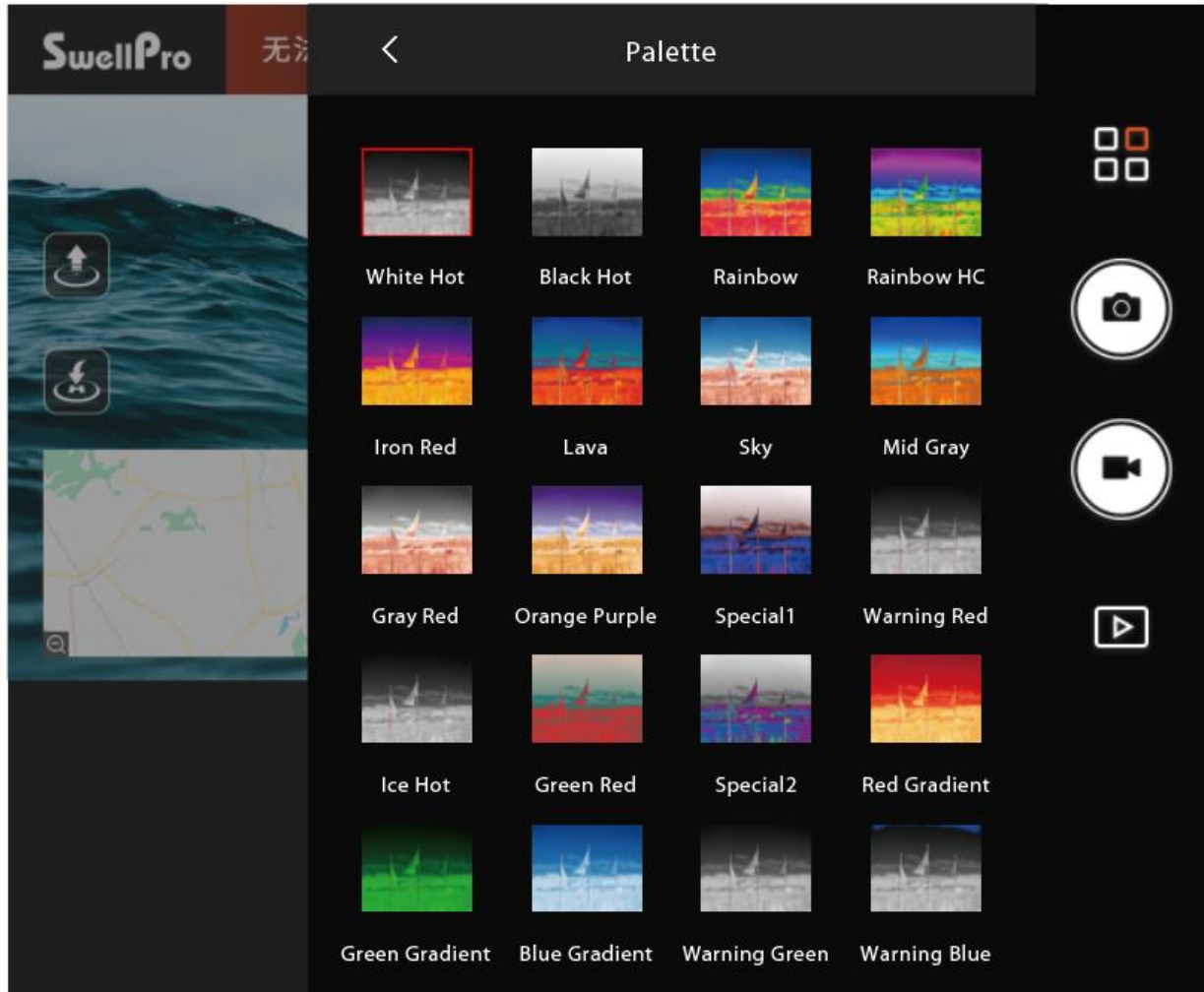

Crosshair

Crosshair marks the frame on the viewfinder.

Contrast

Set the contrast to visualize the infrared thermal imagery better. Set the ratio of the parts which represent the hot and cool part of the imagery.

Brightness

Set the brightness to visualize the infrared thermal imagery better.

DDE (Digital Details Enhancement)

DDE (Digital Details Enhancement) enhance the high spatial frequencies (edges etc.) and appears as boosted lens modulation transfer function, or MTF. The DDE filter attenuates high amplitude signals, making more of the total dynamic range available to display faint objects and details.

Temperature OSD ON/OFF

Turn temperature OSD on or off.

Temperature Unit

Support temperatures display in Celsius (°C), Fahrenheit (°F), and Kelvin (K).

Temperature Alarm

Temperature alarm allows for the detection of any temperatures that arise outside of the set temperature range. Temperature alarm has three options:

- High-Temperature Alarm
- Low-Temperature Alarm
- High & Low-Temperature Alarm

Appendix

Specification

GC3-T Gimbal Thermal Camera

General

Waterproof rating	IP67
Weight	About 430 g
Size	134.5*134.5*117 mm
Memory card	Micro SD card: supports up to 128GB of capacity, write speeds ≥ 40 MB/s, recommend using Class 10 or above, or with UHS-1 rating.
Working temperature	-10°C - 40°C

Gimbal

Stabilization	3-axis (tilt, pan, roll).
Controllable Range	Tilt: -90° to 0°
Max Control Speed	Tilt: 60 °/s

Thermal Camera

Thermal Imager	Uncooled VOx Microbolometer
Sensor Resolution	640 x 512
Lens	Focal length: 19mm Aperture: f/1.0 FOV: 22°H x 18°V
IFOV	0.63 mrad
Pixel Pitch	12 μ m
Spectral Band	8~14 μ m
Sensitivity (NETD)	≤ 50 mK @25°C, f/1.0 (≤ 40 mK Configurable)
Scene Range	-20°C to +150°C (± 3 °C)
Anti-flicker	Auto, 50 Hz, 60 Hz
Photo Format	JPEG
Video Format	MP4, MOV

Low Light Camera	
Sensors	1/2" 2M Starlight CMOS
Lens	FOV: 92.6°
Burst Mode	3/5/10 shoots
Video Resolution	FHD: 1920*1080 50fps HD: 1280*720 50fps
Anti-flicker	Auto, 50 Hz, 60 Hz
Max Data Stream	64 Mbps
Photo Format	JPEG
Video Format	MP4, MOV

Version Information

SwellPro products are constantly improving, so are the product user guides. It is recommended to visit www.swellpro.com to check and download the latest user guide.

Version

Beta 1.0 GC3-T User Guide Beta 1.0 Edition