

Hustler® Parts Manual



HUSTLER®
TURF EQUIPMENT

200 South Ridge Road

Hesston, Kansas

67062



NOTICE OF REQUIREMENT OF SPARK ARRESTER MUFFLER

This equipment may create sparks that can start fires around dry vegetation. California Public Resources Code Section 4442.6 provides that it is unlawful to use or operate an internal combustion engine on any forest-covered, brush-covered, or grass-covered land unless the engine is equipped with a spark arrester maintained in effective working order. A spark arrester is a device constructed of nonflammable materials specifically for the purpose of removing and retaining carbon and other flammable particles over 0.0232 of an inch in size from the exhaust flow of an internal combustion engine that uses hydrocarbon fuels or which is qualified and rated by the United States Forest Service. Other states or federal areas may have similar laws. The Operator Should Contact Local Fire Agencies For Laws or Regulations Relating to Fire Prevention Requirements. **THIS EQUIPMENT DOES NOT HAVE A SPARK ARRESTER AND YOU SHOULD CONTACT YOUR AUTHORIZED DEALER FOR THE PURCHASE OF A SPARK ARRESTER.**

Inspect spark arrester daily; replace every 500 hours or as needed.

The Engine Owner's Manual provides information regarding the U.S. Environmental Protection Agency (EPA) and the California Emission Control Regulation of emission systems, maintenance and warranty.

Keep Engine Owner's Manual with your unit. Should the Engine Owner's Manual become damaged or illegible, replace immediately. Replacements may be ordered per the information found in the Product Information section of the owner's manual.

Federal law and California State law prohibit the following acts or the causing thereof:

1. The removal or rendering inoperative by any person other than for purposes of maintenance, repair, replacement, of any device or element of design incorporated into any equipment for the purposes of emissions control prior to or after its sales or delivery to the ultimate purchaser or while it is in use, or
2. The use of the equipment after such device or element of design has been removed or rendered inoperative by any person.

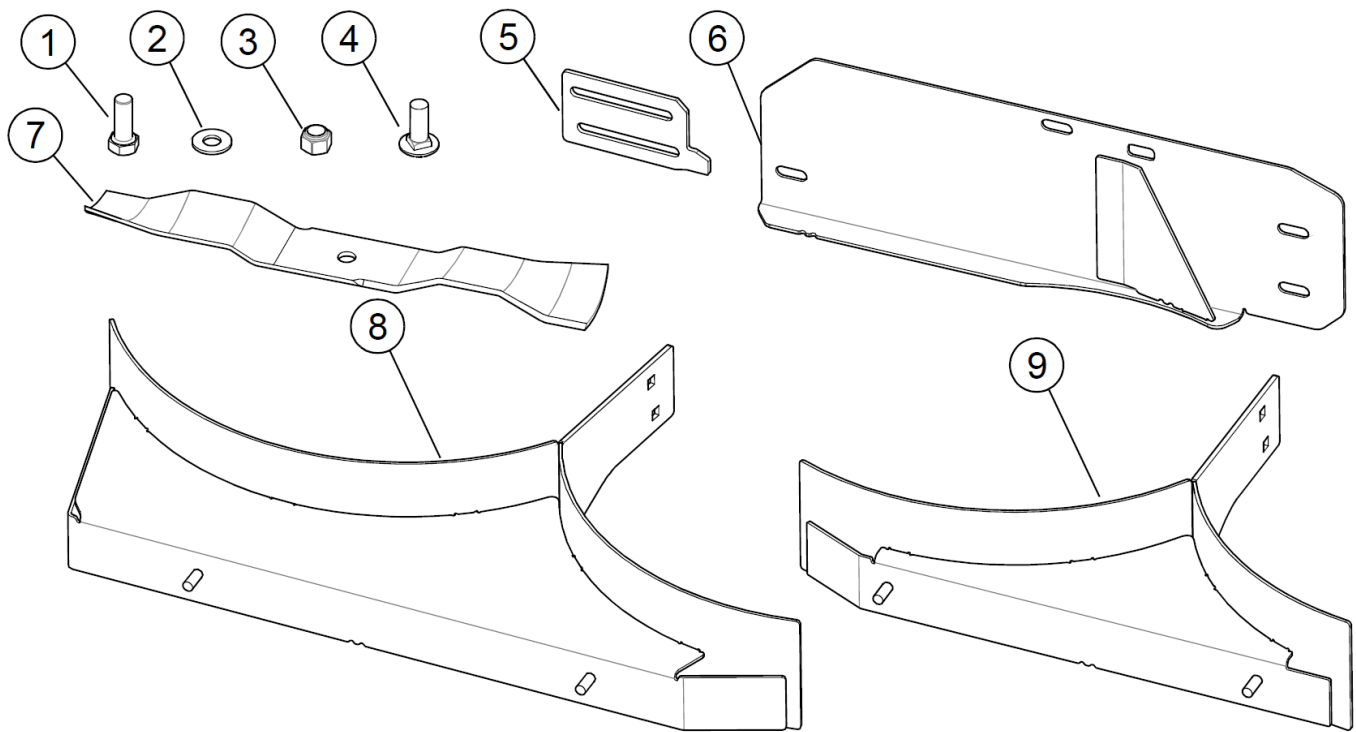

Item	Part No.	Qty	Name
Not Shown	124311	1	54" MULCH KIT
<p>Comments for Part Num. 124311</p> <p>Includes Wavy Mulch Blades.</p>			
1	036244	3	CS .375-16X1.00 HX G5 ZN
2	767954	11	FW 0.379X.82X.06 HD ZN
3	086660	11	NT .375-16NLG8
4	025395	4	CB .375-16X 1.00 G5 ZN
5	113615	2	MULCH, SLIDER PLATE
6	124306-3	1	MULCH CLOSE OFF W/A
7	797704	3	BLADE, 18.50"-MUL-F-CW
8	113738	1	MULCH, CENTER RIGHT
9	113742	1	MULCH, LEFT