

JETSON

Mojo

Dynamic Sound Hoverboard.

A guide for your ride.

IMPORTANT: READ CAREFULLY AND RETAIN FOR FUTURE REFERENCE.

MODELS: JMOJO-BLU | JMOJO-GLD | JMOJO-BLK | JMOJO-PUR |
JMOJO-GRN | JMOJO-SBL | JMOJO-GRY

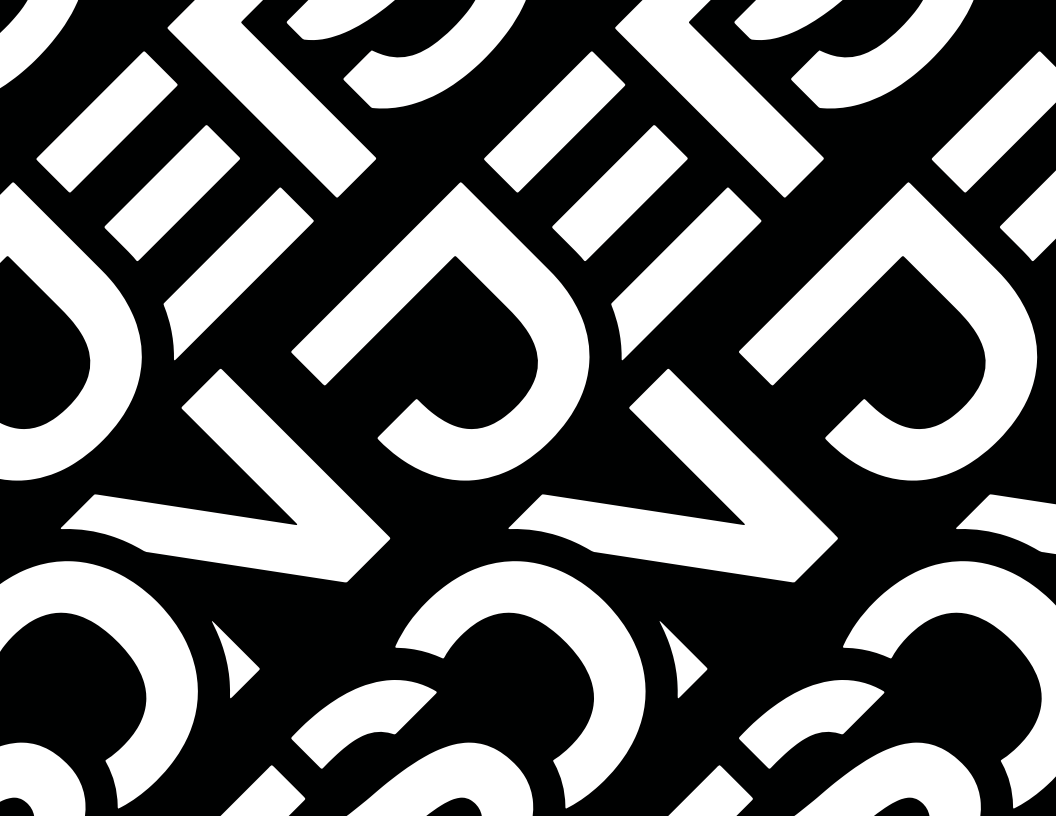

**Jetson's top two riding rules:
Be safe. Have fun!**

Contents

Safety Warnings	4
Warranty Coverage	6
Specs & Features	7
Product Overview	8
Online Resources	10
1. Getting Started	
Charging the Battery	11
Powering On & Off	12
Understanding the Battery Indicator Lights	13
Understanding the Status Indicator Lights	15
How to Recalibrate	16
2. Making Moves	
Mounting the Hoverboard	17
Riding the Hoverboard	18
Making Turns	19
Slowing Down & Stopping	21
Dismounting the Hoverboard	21
Maximizing Speed & Range	21
Using the Bluetooth® Speaker	22
Using the Lights	22
Helmet Safety	23
Care & Maintenance	24

Safety Warnings

- Before use, please read the user manual and safety warnings carefully, and make sure you understand and accept all the safety instructions. The user will be responsible for any loss or damage caused by improper use.
- **Failure to use correct charger can result in fire and explosion.**
- Before each cycle of operation, the operator shall perform the preoperation checks specified by the manufacturer: That all guards and pads originally supplied by the manufacturer are in proper place and in serviceable condition; That the braking system is functioning properly; That any and all axle guards, chain guards, or other covers or guards supplied by the manufacturer are in place and in serviceable condition; That tires are in good condition, inflated properly, and have sufficient tread remaining; The area that the product is to be operated should be safe and suitable for safe operation.
- Components shall be maintained and repaired in accordance with the manufacturer's specifications and using only the manufacturer's authorized replacement parts with installation performed by dealers or other skilled persons.
- Warning against recharging non-rechargeable batteries.
- Don't allow hands, feet, hair, body parts, clothing, or similar articles to come in contact with moving parts, wheels, or drive train, while the motor is running.
- This product should not be used by children or persons with reduced physical, sensory or mental capabilities, or lack of experience and knowledge, unless they have been given supervision or instruction (IEC 60335-1/A2:2006).
- Unsupervised children should not play with the product (IEC 60335-1/A2:2006).
- Adult supervision is required.
- The rider should not exceed 220 lb.
- Units shall not be operated to perform racing, stunt riding, or other maneuvers, which may cause loss of control, or may cause uncontrolled operator/passenger actions or reactions.
- Never use near motor vehicles.
- Avoid sharp bumps, drainage grates, and sudden surface changes. Scooter may suddenly stop.
- Avoid streets and surfaces with water, sand, gravel, dirt, leaves, and other debris. Wet weather impairs traction, braking, and visibility.
- Avoid riding around flammable gas, steam, liquid, or dust that could cause fire.
- Operators shall adhere to all of the manufacturer's recommendations and instructions, as well as comply with all laws and ordinances: Units without headlights shall be operated only with adequate daylight conditions of visibility, and; Owners shall be encouraged to highlight (for conspicuity) using lighting, reflectors, and for low-riding units, signal flags on flexible poles.
- Persons with the following conditions shall be cautioned not to operate: Those with heart conditions; Pregnant women; Persons with head, back, or neck ailments, or prior surgeries to those areas of the body; and persons with any mental or physical conditions that may make them susceptible to injury or impair their physical dexterity or mental capabilities to recognize, understand, and perform all of the safety instructions and to be able to assume the hazards inherent in unit use.
- Do not ride at night.
- Do not ride after drinking or taking prescription medication.
- Do not carry items when riding.
- Never operate the product barefooted.
- Always wear shoes and keep shoelaces tied.
- Make sure your feet are always placed securely on the deck.
- Operators always shall use appropriate protective clothing, including but not limited to a helmet, with appropriate certification, and any other equipment recommended by the manufacturer: Always wear protective equipment such as helmet, knee pads, and elbow pads.
- Always give way to pedestrians.
- Be alert to things in front and far away from you.
- Do not allow distractions when riding, such as answering the phone or engaging in any other activities.
- The product cannot be ridden by more than one person.
- When you ride the product along with other riders, always keep a safe distance to avoid a collision.
- When turning, be sure to maintain your balance.
- Riding with improperly adjusted brakes is dangerous and can result in serious injury or death.
- The brake may become hot while operating, do not touch the brake with your bare skin.
- Applying brakes too hard or too suddenly can lock up a wheel, which could cause you to lose control and fall. Sudden or excessive application of the brake may result in injury or death.
- If the brake loosens, please adjust with the hexagon wrench, or please contact Jetson Customer Care.

- Replace worn or broken parts immediately.
- Check whether all safety labels are in place and understood before riding.
- The owner shall allow the use and operation of the unit after a demonstration that such operators can understand and operate all components of the unit before use.
- Do not ride without proper training. Do not ride at high speeds, on uneven terrain, or on slopes. Do not perform stunts or turn abruptly.
- Recommended for indoor use.
- Prolonged exposure to UV rays, rain and the elements may damage the enclosure materials, store indoors when not in use.
- Personal e-mobility devices are not intended for use at elevations greater than 2000 m above sea level.

AVERTISSEMENT - Risque d'incendie - Aucune des pieces ne peut être réparée par l'utilisateur.

MODIFICATIONS

Do not attempt to disassemble, modify, repair, or replace the unit or any components of the unit without instruction from Jetson Customer Care. This will void any warranty, and can lead to malfunctions which may cause injury.

ADDITIONAL OPERATION PRECAUTIONS

Do not lift the product off the ground while it is on and the wheels are in motion. This can result in freely spinning wheels, which may cause injury to yourself or others nearby. Do not jump on or off the product, and do not jump while using it. Always keep your feet firmly planted on the foot rest while in operation. Always check the battery charge before using.

NOTICE OF COMPLIANCE

This device complies with Part 15 of the FCC Rules. Operation is subject to the following two conditions:

(1) this device may not cause harmful interference, and (2) this device must accept any interference received, including interference that may cause undesired operation. Warning: Changes or modifications to this unit not expressly approved by the party responsible for compliance could void the user's authority to operate the equipment.

NOTE: This equipment has been tested and found to comply with the limits for a Class B digital device, pursuant to Part 15 of the FCC Rules. These limits are designed to provide reasonable protection against harmful interference in a residential installation. This equipment generates, uses and can radiate radio frequency energy and, if not installed and used in accordance with the instructions, may cause harmful interference to radio communications. However, there is no guarantee that interference will not occur in a particular installation. If this equipment does cause harmful interference to radio or television reception, which can be determined by turning the equipment off and on, the user is encouraged to try to correct the interference by one or more of the following measures:

- Reorient or relocate the receiving antenna.
- Increase the separation between the equipment and receiver.
- Connect the equipment into an outlet on a circuit different from that to which the receiver is connected.
- Consult the dealer or an experienced radio/ TV technician for help.

Shielded cables must be used with this unit to ensure compliance with the Class B FCC limits.

DISPOSAL OF USED BATTERY

 Battery may contain hazardous substances which could endanger the environment and human health. This symbol marked on the battery and/ or packaging indicates that used battery shall not be treated as municipal waste. Batteries should be disposed of at an appropriate collection point for recycling. By ensuring the used batteries are disposed of correctly, you will help preventing potential negative consequences for the environment and human health. The recycling of materials will help to conserve natural resources. For more information about recycling of used batteries, please contact your local municipality waste disposal service.

California Proposition 65

WARNING

This product can expose you to chemicals including Cadmium, which is known to the State of California to cause cancer and birth defects or other reproductive harm. For more information go to: www.P65Warnings.ca.gov.

Warranty Coverage

GENERAL LIMITED WARRANTY

Your new Jetson product is warranted against defects in materials and workmanship as indicated on ridejetson.com/warranty for a period of time from the date of original retail purchase when used in accordance with Jetson's user manuals (refer to ridejetson.com/support). **Under this warranty, you will be able to direct your claims to Jetson even in situations where you purchased the Jetson Product from one of our authorized retailers.** To read the full terms of our warranty, visit ridejetson.com/warranty.

Specs & Features

- **WEIGHT LIMIT: 220 LBS**
- **PRODUCT WEIGHT: 13.0 LBS**
- **WHEEL SIZE: 6.5"**
- **PRODUCT DIMENSIONS: 23.4" (L) X 7.7" (W) X 7.1" (H)**
- **MAX SPEED: 10 MPH***
- **MAX RANGE: 8 MILES***
- **BATTERY: 36V 2.0AH LITHIUM-ION**
- **MOTOR: 300W*, DUAL-HUB**
- **CHARGER: 100-240V**
- **CHARGING TIME: ABOUT 5 HOURS**
- **MAX CLIMBING ANGLE: 10°**
- **RECOMMENDED AGE: 12+**
- **PRODUCT UL CERTIFICATION: 2272**

*PRODUCT RANGE, SPEED, BATTERY LIFE, AND OTHER SPECIFICATIONS MAY VARY BASED ON RIDER AND RIDING CONDITIONS. SEE PAGE 21 FOR MORE DETAILS ON CONDITIONS THAT CAN AFFECT PERFORMANCE.

*PEAK POWER

Product Overview

1. STATUS INDICATOR LIGHT
2. BATTERY INDICATOR LIGHTS
3. FOOTPAD (LED LIGHT-UP)
4. WHEEL
5. RIM (LED LIGHT-UP)
6. POWER BUTTON
7. CHARGING PORT
8. CHARGER

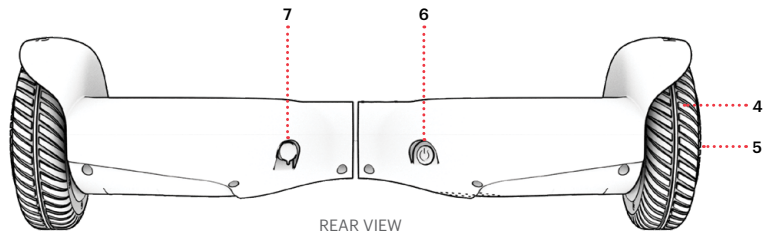
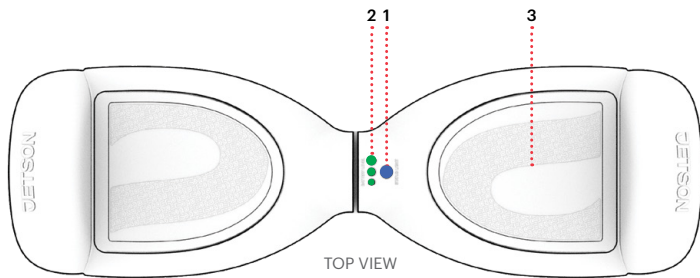

NOTE: IMAGES MAY NOT REFLECT EXACT APPEARANCE OF ACTUAL PRODUCT.

Online Resources

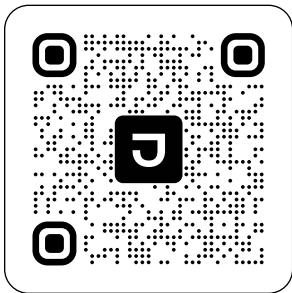

Scan for our most updated Mojo onboarding materials and support resources.

⚠️WARNING:

FAILURE TO COMPLY WITH THE FOLLOWING INSTRUCTIONS MAY RESULT IN INJURY TO THE CHILD OR OTHERS.

- KEEP SMALL PARTS AWAY FROM CHILDREN DURING ASSEMBLY.
- ACCESSORY MUST BE ASSEMBLED AND REMOVED BY AN ADULT.
- FREQUENTLY INSPECT THE PRODUCT FOR DAMAGE.

* ADULTS MUST ASSIST CHILDREN IN THE ASSEMBLY AND INITIAL ADJUSTMENT PROCEDURES OF THE PRODUCT.

1. Getting Started

1.1 Charging the Battery

IMPORTANT CHARGING NOTES:

- ONLY USE THE INCLUDED CHARGER OR ONE OBTAINED DIRECTLY THROUGH JETSON LABELED WITH: PJMOJO-CH OR CH42040P
 FAILURE TO USE CORRECT CHARGER CAN RESULT IN FIRE AND EXPLOSION.
- PLUG THE CHARGER INTO THE WALL OUTLET BEFORE PLUGGING INTO THE CHARGING PORT ON THE HOVERBOARD.
- NEVER TURN ON THE HOVERBOARD WHILE IT IS CHARGING.
- CHARGE THE BATTERY UNTIL IT IS FULLY CHARGED— ABOUT 5 HOURS.
- NEVER LEAVE THE HOVERBOARD CHARGING OVERNIGHT OR FOR EXTENDED PERIODS OF TIME.
- DO NOT ATTEMPT TO REMOVE OR DISASSEMBLE THE BATTERY.

CHARGER INDICATOR LIGHT ON THE CHARGER:

- - CHARGING
- - CHARGING COMPLETE

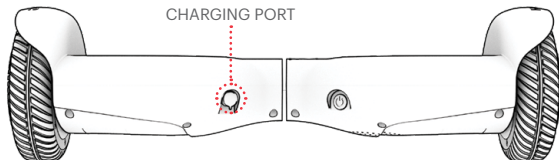
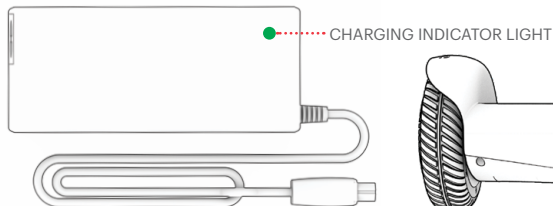

THIS IS THE MARKING YOUR CHARGER WILL HAVE.

1.2 Powering On & Off

TO POWER ON OR OFF: QUICK-PRESS THE POWER BUTTON.

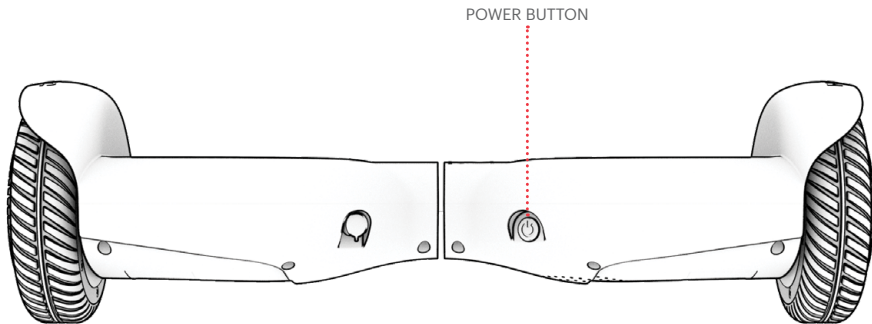



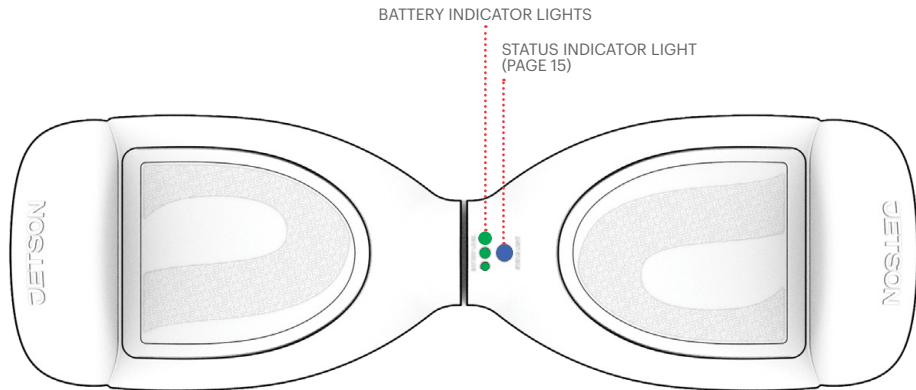

THE HOVERBOARD WILL AUTOMATICALLY SHUT OFF AFTER STANDING IDLE FOR 10 MINUTES.

1.3 Understanding the Battery Indicator Lights





WHEN POWERED ON FOR USE, BATTERY INDICATOR LIGHTS WILL ILLUMINATE TO INDICATE CHARGE PERCENTAGES AS INDICATED IN THE TABLE BELOW.

WARNING: AS A SAFETY PRECAUTION, THE FRONT OF THE HOVERBOARD WILL AUTOMATICALLY TILT UP AND IT WILL SLOW DOWN WHEN THE BATTERY CHARGE DIPS BELOW 10%.

BATTERY INDICATOR LIGHTS	CHARGE PERCENTAGE
 3 SOLID LIGHTS	75 - 100% CHARGED
 2 SOLID LIGHTS	30 - 74% CHARGED
 ONE SOLID LIGHT	10 - 29% CHARGED (CHARGE YOUR HOVERBOARD NOW!)
 1 FLASHING LIGHT & LOW BATTERY CHARGE ANNOUNCEMENT FROM SPEAKER	5 - 9% CHARGED (REALLY. IT'S TIME TO CHARGE!)
 1 FLASHING LIGHT, LOW BATTERY CHARGE ANNOUNCEMENT FROM SPEAKER, & CONTINUOUS BEEPING	1 - 4% (STOP RIDING AND CHARGE YOUR HOVERBOARD!)

1.4 Understanding the Status Indicator Light

STATUS LIGHT		
STATUS	YOUR HOVERBOARD IS ALL SET.	RECALIBRATE YOUR HOVERBOARD! (SEE PAGE 16.)

1.5 How to Recalibrate

SOMETIMES THE INTERNAL BALANCE MECHANISMS ON A HOVERBOARD NEED TO BE RESET, OR "RECALIBRATED."

IMPORTANT: RECALIBRATE YOUR HOVERBOARD STRAIGHT OUT OF THE BOX. THEN, RECALIBRATE AS NECESSARY. SIGNS YOUR HOVERBOARD MIGHT NEED RECALIBRATING INCLUDE CONSTANT BEEPING AND/OR SPINNING OF THE WHEELS.

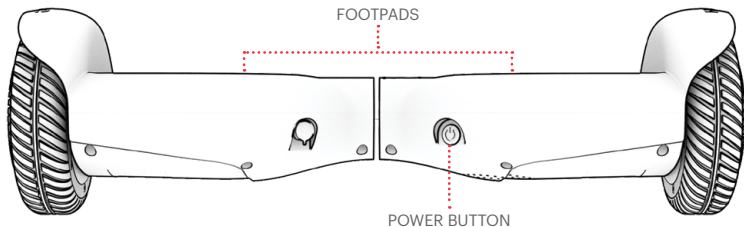

TO RECALIBRATE:

1. POWER OFF YOUR HOVERBOARD.
2. PLACE YOUR HOVERBOARD ON A FLAT SURFACE AND LEVEL THE FOOTPADS SO THEY ARE EVENLY ALIGNED AND PARALLEL TO THE GROUND.
3. PRESS AND HOLD THE POWER BUTTON FOR ABOUT 5 SECONDS, AND YOU WILL HEAR THE START OF A MUSICAL TUNE.
4. CONTINUE TO HOLD THE BUTTON UNTIL YOU HEAR THE WORDS "CALIBRATION SUCCESSFUL."
5. RELEASE THE POWER BUTTON, AND THEN PRESS AND HOLD THE POWER BUTTON FOR 3 SECONDS TO TURN OFF THE HOVERBOARD.
6. PRESS AND HOLD THE POWER BUTTON FOR 1 SECOND TO TURN THE HOVERBOARD BACK ON. RECALIBRATION IS NOW COMPLETE.

IMPORTANT: DO NOT LEAN OR APPLY ANY WEIGHT ON THE HOVERBOARD DURING THE RECALIBRATION PROCESS.

NOTE: IT MAY TAKE A FEW RECALIBRATION ATTEMPTS TO FULLY RESET THE HOVERBOARD'S INTERNAL BALANCE MECHANISMS.

2. Making Moves

STARTING NOTES:

- WHEN IT COMES TO RIDING, THERE IS NO TECHNICAL FRONT OR BACK OF THE HOVERBOARD. THE RIDER CAN STEP ON FROM EITHER SIDE.
- THE DIRECTIONS GIVEN IN THIS MANUAL—RIGHT, LEFT, FRONT/FORWARD, AND REAR/BACK—ARE ORIENTED AS THE RIDER WOULD SEE THEM WHEN STANDING ON THE HOVERBOARD. THE "RIGHT SIDE" OF THE HOVERBOARD, FOR EXAMPLE, IS THE SIDE WHERE THE RIDER'S RIGHT FOOT WILL BE.

2.1 Mounting the Hoverboard

IMPORTANT: NEVER TRY TO MOUNT A HOVERBOARD THAT IS POWERED OFF. THE INTERNAL BALANCE MECHANISMS ONLY ACTIVATE WHEN THE HOVERBOARD IS POWERED ON.

1. POWER ON YOUR HOVERBOARD.
2. POSITION IT ON THE GROUND IN FRONT OF YOU AND PLACE ONE FOOT IN THE CENTER OF THE FOOTPAD IN FRONT OF IT.
3. LIFT YOUR OTHER FOOT ONTO THE OTHER FOOTPAD, AND QUICKLY SHIFT YOUR WEIGHT TO THE CENTER OF YOUR BODY.
4. STAND STRAIGHT, KEEPING A SLIGHT BEND IN THE KNEES.

2.2 Riding the Hoverboard

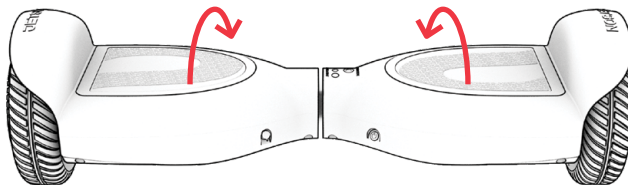

TO MOVE FORWARD: APPLY EQUAL PRESSURE TO THE FRONT OF EACH FOOTPAD WITH YOUR TOES.

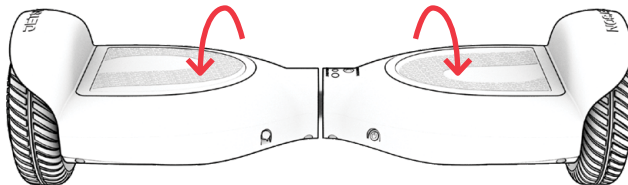

TO MOVE BACKWARDS: APPLY EQUAL PRESSURE TO THE BACK OF EACH FOOTPAD WITH YOUR HEELS.

IMPORTANT: WHEN THE HOVERBOARD IS TRAVELING NEAR OR AT MAX SPEED, IT WILL START BEEPING CONTINUOUSLY AS A WARNING TO SLOW DOWN.

2.3 Making Turns

THE MORE PRESSURE YOU APPLY TO A FOOTPAD, THE FASTER THE WHEEL ON THAT SIDE WILL ROTATE.

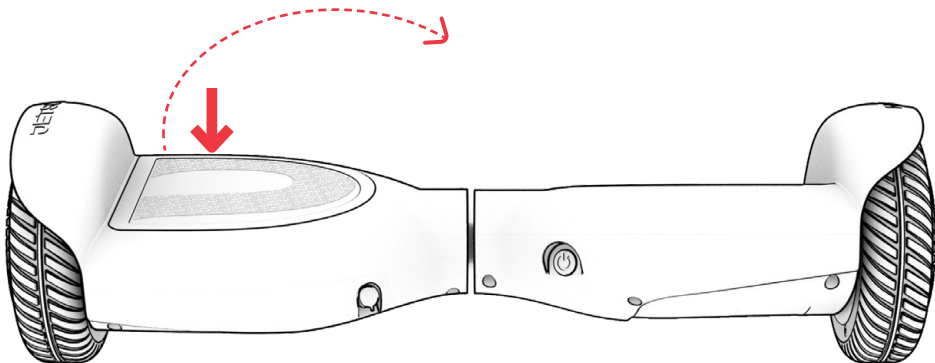

TO TURN RIGHT: APPLY EXTRA PRESSURE TO THE FRONT OF THE LEFT FOOTPAD WITH THE TOES ON YOUR LEFT FOOT.

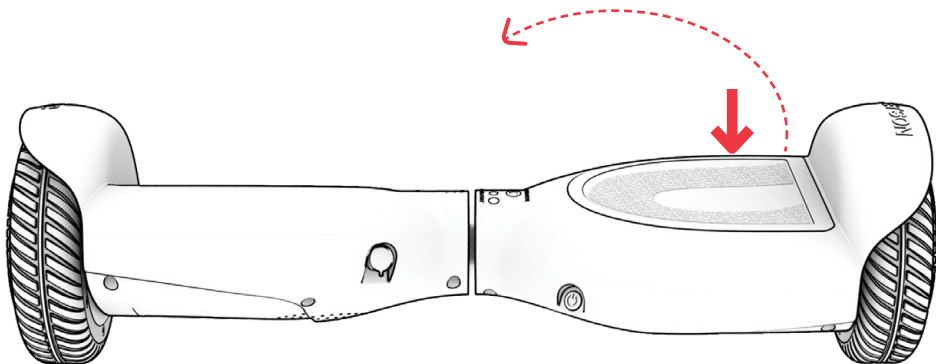

TO TURN LEFT: APPLY EXTRA PRESSURE TO THE FRONT OF THE RIGHT FOOTPAD WITH YOUR RIGHT FOOT.

2.4 Slowing Down & Stopping

TO SLOW DOWN WHILE RIDING FORWARDS, EASE UP ON THE PRESSURE BEING APPLIED TO THE FRONT OF THE FOOTPADS. BRING YOUR BODY WEIGHT OVER THE CENTER OF EACH FOOTPAD TO COME TO A STOP.

2.5 Dismounting the Hoverboard

ONCE THE BOARD HAS COME TO A STOP, DISMOUNT IT BY STEPPING OFF **BEHIND** IT ONE FOOT AT A TIME.

IMPORTANT: FOR SAFETY, NEVER DISMOUNT THE HOVERBOARD BY STEPPING OFF IN FRONT OF IT.

2.6 Maximizing Speed & Range

THE MAXIMUM RANGE PER BATTERY CHARGE IS UP TO 8 MILES AND THE MAXIMUM ACHIEVABLE SPEED IS 10 MPH. HOWEVER, MANY FACTORS WILL AFFECT HOW FAR YOU CAN GO PER CHARGE AND HOW FAST YOU CAN RIDE.

- RIDING SURFACE: A SMOOTH, FLAT SURFACE WILL INCREASE SPEED AND RANGE.
- WEIGHT: MORE WEIGHT COULD RESULT IN LESS DISTANCE AND SLOWER SPEEDS.
- TEMPERATURE: RIDE, CHARGE, AND STORE THE HOVERBOARD ABOVE 50°F.
- RIDING STYLE: FREQUENT STARTING AND STOPPING WILL REDUCE ACHIEVABLE RANGE.

2.7 Using the Bluetooth® Speaker

THE MOJO HAS A BUILT-IN BLUETOOTH® SPEAKER.

STREAMING MUSIC THROUGH YOUR HOVERBOARD

YOU CAN CONNECT YOUR HANDHELD DEVICE TO THE HOVERBOARD'S BUILT-IN BLUETOOTH® SPEAKER TO STREAM MUSIC DURING YOUR RIDE. ONCE THE MUSIC STARTS PLAYING, THE LIGHTS ON YOUR HOVERBOARD WILL AUTOMATICALLY SYNC WITH THE MUSIC AND FLASH TO ITS BEAT.

TO CONNECT YOUR HANDHELD DEVICE TO THE HOVERBOARD'S BLUETOOTH® SPEAKER:

1. POWER ON THE HOVERBOARD.
2. IN THE SETTINGS SECTION ON YOUR HANDHELD DEVICE, ENABLE BLUETOOTH AND LOOK FOR "MOJO" IN THE LIST OF OPTIONS. SELECT IT.
3. PLAY MUSIC THROUGH YOUR FAVORITE APP, AND IT WILL STREAM THROUGH THE HOVERBOARD'S SPEAKERS.

TROUBLESHOOTING CONNECTIVITY ISSUES

IF YOU ARE HAVING TROUBLE CONNECTING WITH THE SPEAKER, TRY:

1. POWERING THE HOVERBOARD OFF AND THEN BACK ON.
2. POWERING YOUR PERSONAL DEVICE OFF AND THEN BACK ON.
3. CLICKING THE SCAN BUTTON TO REFRESH THE LIST OF DETECTED PRODUCTS.

2.8 Using the Lights

THERE ARE 5 DIFFERENT LIGHTING EFFECTS THAT YOU CAN CHOOSE FROM. TO TOGGLE AMONGST THEM, QUICK-PRESS THE HOVERBOARD POWER BUTTON WHILE THE HOVERBOARD IS POWERED ON.

THE LIGHTS WILL PULSE IN SYNC WITH THE BEAT OF THE MUSIC THAT YOU HAVE STREAMING FROM THE BLUETOOTH® SPEAKER.

The Bluetooth® word mark and logos are registered trademarks owned by the Bluetooth SIG, inc. And any use of such marks by Jetson Electric Bike LLC. is under license. Other trademarks and trade names are those of their respective owners.

2.9 Helmet Safety

A HELMET SHOULD BE WORN AT ALL TIMES.



**PROPER POSITIONING:
THE FOREHEAD IS COVERED
BY THE HELMET.**



**IMPROPER POSITIONING:
THE FOREHEAD IS EXPOSED.
A FALL COULD RESULT IN SERIOUS INJURY.**

* WEAR A HELMET, APPROPRIATE CLOTHING, SHOES, AND SAFETY GEAR. AVOID CLOTHING THAT CAN GET CAUGHT INTO OR UNDER THE WHEELS. CLOSED-TOE, FLAT SHOES ARE RECOMMENDED. WEAR AN ASTM F1492 APPROVED HELMET AND PROTECTIVE GEAR TO PREVENT INJURY IN THE EVENT OF AN ACCIDENT.

Care & Maintenance

HANDLING THE MOJO

- DO NOT LIFT THE HOVERBOARD OFF OF THE GROUND WHEN IT IS POWERED ON. AS A REMINDER TO PUT THE HOVERBOARD BACK ON A SOLID SURFACE, THE WHEELS WILL DO A QUICK SPIN AND THEN THE HOVERBOARD WILL START BEEPING CONTINUOUSLY. TO STOP THE BEEPING, TURN THE HOVERBOARD OFF BY QUICK-PRESSING THE POWER BUTTON.

CLEANING THE MOJO

- TO CLEAN THE HOVERBOARD, CAREFULLY WIPE WITH A DAMP CLOTH AND THEN DRY WITH A DRY CLOTH. DO NOT APPLY WATER DIRECTLY TO THE HOVERBOARD, AS THE ELECTRICAL AND ELECTRONIC SYSTEMS MAY GET WET, WHICH COULD LEAD TO A MALFUNCTION THAT PUTS RIDER SAFETY AT RISK.
- IF THE ELECTRIC PARTS OR BATTERY GET WET, DO NOT POWER ON THE HOVERBOARD. CONTACT THE JETSON CARE TEAM FOR ASSISTANCE.

BATTERY CARE AND PRECAUTIONS

- KEEP AWAY FROM FIRE AND EXCESSIVE HEAT.
- TIMELY BATTERY CHARGING AFTER EVERY RIDE WILL PROLONG BATTERY LIFE.
- AVOID INTENSE PHYSICAL IMPACT AND/OR SEVERE VIBRATION.
- PROTECT FROM WATER AND MOISTURE.
- DO NOT DISASSEMBLE THE HOVERBOARD OR ITS BATTERY.
- CONTACT THE JETSON CARE TEAM IF THERE ARE ANY ISSUES WITH THE BATTERY.

STORING THE MOJO

- FULLY CHARGE THE BATTERY BEFORE STORING THE HOVERBOARD FOR EXTENDED PERIODS OF TIME.
- WHEN IN STORAGE FOR EXTENDED PERIODS OF TIME, FULLY CHARGE THE BATTERY ONCE A MONTH.
- COVER THE HOVERBOARD TO PROTECT IT AGAINST DUST.
- STORE THE HOVERBOARD INDOORS AND IN A DRY PLACE.

Stay connected.

Be sure to follow **@ridejetson** on social media to learn about fantastic offers, giveaways, and all the latest Jetson news.



Loving your ride?

Then be sure to leave a review at ridejetson.com/reviews.
We can't wait to hear from you!

JETSON

#MakeMoves

Questions? Let us help.

ridejetson.com/support
ridejetson.com/chat

To exercise your product's warranty or inquire about warranty coverage, contact us directly.

US/CANADA: 1-888-976-9904
UK: +44 1355 241222

Manufactured in Yueyang, China
Imported by Jetson Electric Bikes LLC.
P.O. Box 320149, 775 4th Ave #2,
Brooklyn, NY 11232

www.ridejetson.com



Made in China
Date Code: 08/2023
Document Edition: v2.0