

JETSON

Mars Light-Up Folding Scooter.

A guide for
your ride.

SKU: JMARS-BLK | JMARS-IRS





**Remember to be
safe and
most importantly,
have fun!**

What's in the Box

1. Handlebar
2. Stem Clamp
3. LED Light-Up Stem
4. Quick Release Lever
5. Front Wheel
6. Knob
7. Power Button
8. Deck
9. Rear Foot Brake
10. Rear Wheel



Specs & Features

- Weight Limit: 150 lb
- Product Weight: 7 lb
- Recommended Age: 5+
- Wheel Size: 4.66"
- Unfolded Dims: 28" x 11.75" x 34.5"
- Folded Dims: 27.5" x 11.75" x 8.75"
- Deck Size: 20.5" x 4.4"
- Height Adjustable Handlebar: 25.5"-34.5"
- Rear Foot Brake
- LED Light-Up Wheels, Deck & Stem
- Easy Folding Mechanism

1. Get Started

1.1 Assembly

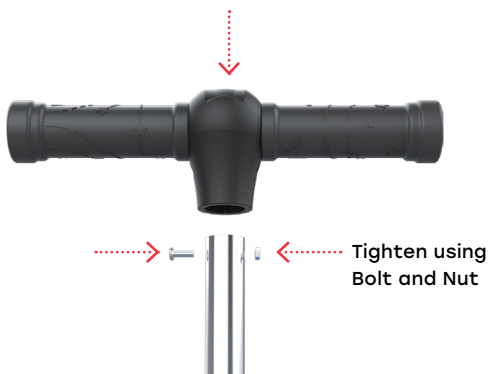

Quick Note: Place the Nut on the right side when facing the front of the Mars.

1.2 Unfolding / Folding the Mars

Open the Locking Lever

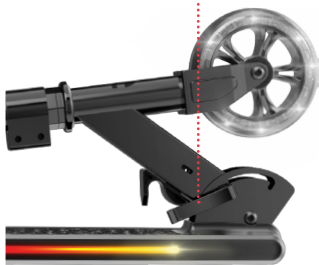

Loosen Knob

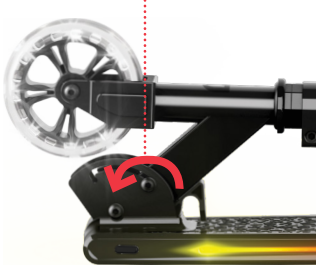

Pull up on the Quick Release Lever

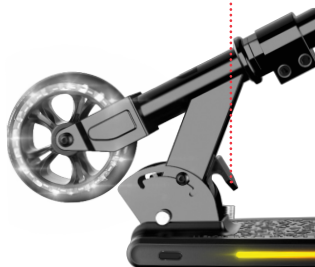

- Pull Stem up. Once you hear it click, it's fully unfolded.
- Close the Locking Lever and tighten the Knob.
- Reverse these steps to fold the Mars.

*Adults must assist children in the initial assembly and adjustment procedures to fold/unfold product and adjust handlebar to height.

1.3 Adjusting the Handlebar

Open the Stem Clamp

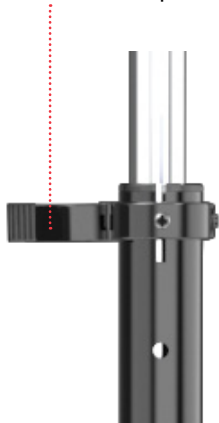

Lift (or lower) Handlebar

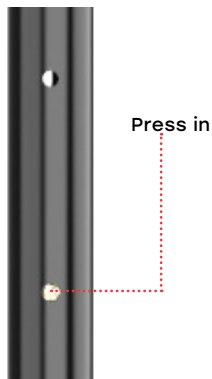

When you hear it click, close Stem Clamp to lock. Make sure the Handlebar is secure.

1.4 Using the Brake

Press down to come to a complete stop.

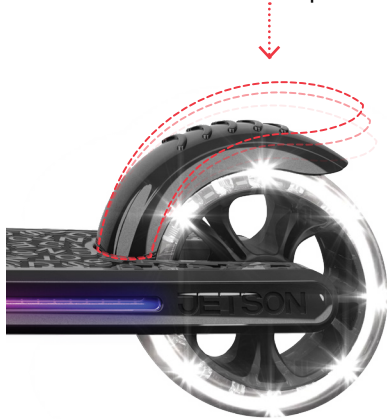

1.5 Changing the Batteries

Battery Door



BATTERY DOOR

1. Open the Battery Door with a screwdriver.
2. Place 3 AA batteries inside.
3. Close the Battery Door with that same screwdriver.
4. You're all set!

1.6 LED Lights



LED LIGHT FUNCTIONS

1. Press the Power Button to turn on the LED Lights.
2. You can cycle through 20 different light functions by pressing on the Power Button.
3. To skip the cycle and turn off the lights hold the Power Button for 3 seconds.

Quick Note: Remember to turn off the lights when you're done riding the Mars to save battery life!

2. Make Moves

2.1 Riding the Mars

- Place one foot in front.
- Place the other foot in back, at a 70-90° angle.
- Turn the handlebar to the left or right to make turns.

*Please Note: Images may not reflect exact appearance of actual product.

Care & Maintenance

CLEANING THE LUMI

To clean the Mars, carefully wipe with a damp cloth, then dry with a dry cloth. Do not use water to clean the Mars, this may damage the frame.

FEW MUST-DO'S

- Keep away from fire and excessive heat.
- Avoid intense physical shock, severe vibration, or impact.
- Please ride the Lumi on a smooth, flat surface.
- Protect from water or moisture.
- Contact Jetson Customer Support if there are any issues.

STORAGE

- Store the Mars indoors, in a dry place.
- Cover the Mars to protect against dust.

MODIFICATIONS

Do not attempt to disassemble, modify, repair, or replace the product or any components of the unit without instruction from Jetson Customer Support. This will void any warranty, and can lead to malfunctions which may cause injury.

ADDITIONAL OPERATION CAUTIONS

Do not lift the product off the ground while it is on and the wheels are in motion. This can result in freely spinning wheels, which may cause injury to yourself or others nearby. Do not jump on or off the product, and do not jump while using it. Always keep your feet firmly planted on the mat sensors while in operation. Always check the battery charge before using.

DISPOSAL OF USED BATTERY



Battery may contain hazardous substances which could endanger the environment and human health. This symbol marked on the battery and/or packaging indicates that used battery shall not be treated as municipal waste. Batteries should be disposed of at an appropriate collection point for recycling. By ensuring the used batteries are disposed of correctly, you will help preventing potential negative consequences for the environment and human health. The recycling of materials will help to conserve natural resources. For more information about recycling of used batteries, please contact your local municipality waste disposal service.

Safety Warnings

- Before use, please read the user manual and safety warnings carefully, and make sure you understand and accept all the safety instructions. The user will be responsible for any loss or damage caused by improper use.
- Before each cycle of operation, the operator shall perform the preoperation checks specified by the manufacturer: That all guards and pads originally supplied by the manufacturer are in proper place and in serviceable condition; That the braking system is functioning properly; That any and all axle guards, chain guards, or other covers or guards supplied by the manufacturer are in place and in serviceable condition; That tires are in good condition, inflated properly, and have sufficient tread remaining; The area that the product is to be operated should be safe and suitable for safe operation.
- Components shall be maintained and repaired in accordance with the manufacturer's specifications and using only the manufacturer's authorized replacement parts with installation performed by dealers or other skilled persons.
- Warning against recharging non-rechargeable batteries.
- Don't allow hands, feet, hair, body parts, clothing, or similar articles to come in contact with moving parts, wheels, or drive train, while the motor is running.
- This product should not be used by children or persons with reduced physical, sensory or mental capabilities, or lack of experience and knowledge, unless they have been given supervision or instruction (IEC 60335-1/A2:2006).
- Unsupervised children should not play with the product (IEC 60335-1/A2:2006).
- Adult supervision is required.
- The rider should not exceed 150lb.
- Units shall not be operated to perform racing, stunt riding, or other maneuvers, which may cause loss of control, or may cause uncontrolled operator/passenger actions or reactions.
- Never use near motor vehicles.
- Avoid sharp bumps, drainage grates, and sudden surface changes. Scooter may suddenly stop.
- Avoid streets and surfaces with water, sand, gravel, dirt, leaves, and other debris. Wet weather impairs traction, braking, and visibility.
- Avoid riding around flammable gas, steam, liquid, or dust that could cause fire.
- Operators shall adhere to all of the manufacturer's recommendations and instructions, as well as comply with all laws and ordinances: Units without headlights shall be operated only with adequate daylight conditions of visibility, and; Owners shall be encouraged to highlight (for conspicuity) using lighting, reflectors, and for low-riding units, signal flags on flexible poles.
- Persons with the following conditions shall be cautioned not to operate: Those with heart conditions; Pregnant women; Persons with head, back, or neck ailments, or prior surgeries to those areas of the body; and persons with any mental or physical conditions that may make them susceptible to injury or impair their physical dexterity or mental capabilities to recognize, understand, and perform all of the safety instructions and to be able to assume the hazards inherent in unit use.
- Do not ride at night.
- Do not ride after drinking or taking prescription medication.
- Do not carry items when riding.
- Never operate the product barefooted.
- Always wear shoes and keep shoelaces tied.
- Make sure your feet are always placed securely on the deck.
- Operators always shall use appropriate protective clothing, including but not limited to a helmet, with appropriate certification, and any other equipment recommended by the manufacturer: Always wear protective equipment such as helmet, knee pads, and elbow pads.
- Always give way to pedestrians.
- Be alert to things in front and far away from you.
- Do not allow distractions when riding, such as answering the phone or engaging in any other activities.
- The product cannot be ridden by more than one person.
- When you ride the product along with other riders, always keep a safe distance to avoid a collision.
- When turning, be sure to maintain your balance.
- Riding with improperly adjusted brakes is dangerous and can result in serious injury or death.
- The brake may become hot while operating, do not touch the brake with your bare skin.
- Applying brakes too hard or too suddenly can lock up a wheel, which could cause you to lose control and fall. Sudden or excessive application of the brake may result in injury or death.
- If the brake loosens, please adjust with the hexagon wrench, or please contact Jetson Customer Support.
- Replace worn or broken parts immediately.
- Check whether all safety labels are in place and understood before riding.
- The owner shall allow the use and operation of the unit after a demonstration that such operators can understand and operate all components of the unit before use.
- Do not ride without proper training. Do not ride at high speeds, on uneven terrain, or on slopes. Do not perform stunts or turn abruptly.
- Recommended for indoor use.
- Prolonged exposure to UV rays, rain and the elements may damage the enclosure materials, store indoors when not in use.

California Proposition 65

WARNING:

This product can expose you to a chemical such as Chromium that is known to the state of California to cause cancer or birth defects or other reproductive harm. For more information go to www.p65warnings.ca.gov/product

NOTICE OF COMPLIANCE

This device complies with Part 15 of the FCC Rules. Operation is subject to the following two conditions: (1) this device may not cause harmful interference, and (2) this device must accept any interference received, including interference that may cause undesired operation.

Warning: Changes or modifications to this unit not expressly approved by the party responsible for compliance could void the user's authority to operate the equipment.

NOTE: This equipment has been tested and found to comply with the limits for a Class B digital device, pursuant to Part 15 of the FCC Rules. These limits are designed to provide reasonable protection against harmful interference in a residential installation. This equipment generates, uses and can radiate radio frequency energy and, if not installed and used in accordance with the instructions, may cause harmful interference to radio communications. However, there is no guarantee that interference will not occur in a particular installation. If this equipment does cause harmful interference to radio or television reception, which can be determined by turning the equipment off and on, the user is encouraged to try to correct the interference by one or more of the following measures:

- Reorient or relocate the receiving antenna.
- Increase the separation between the equipment and receiver.
- Connect the equipment into an outlet on a circuit different from that to which the receiver is connected.
- Consult the dealer or an experienced radio/ TV technician for help.

Shielded cables must be used with this unit to ensure compliance with the Class B FCC limits.

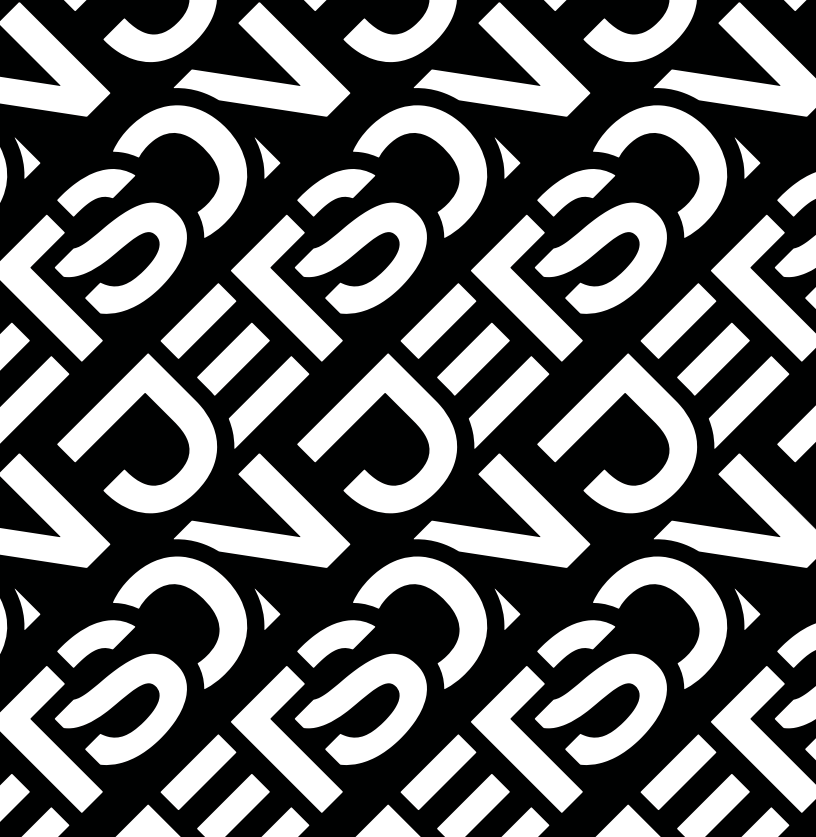

Enjoying the ride?

Leave a review on ridejetson.com/reviews or share your photos with us online using the #RideJetson hashtag!

Questions? Let us know.

support.ridejetson.com

Hours of Operation: 7 Days a Week, 10am-6pm
US 1-(888) 976-9904 | UK +44 (0)33 0838 2551

www.ridejetson.com



Follow us [@ridejetson](https://twitter.com/ridejetson)
[#MakeMoves](https://www.instagram.com/ridejetson)



Imported by Jetson Electric Bikes LLC.
86 34th Street 4th Floor, Brooklyn NY 11232



Date Code: 08/2020
Made in China