

JETSON

**Impulse
Extreme-Terrain
Combo.**

**A guide for
your ride.**

Model: JIMPULSE-WHT



**Remember to be
safe and
most importantly,
have fun!**



What's in the Box

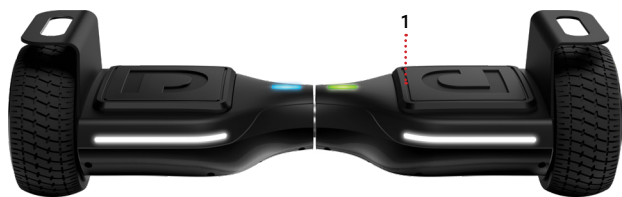

1. Astro Hoverboard

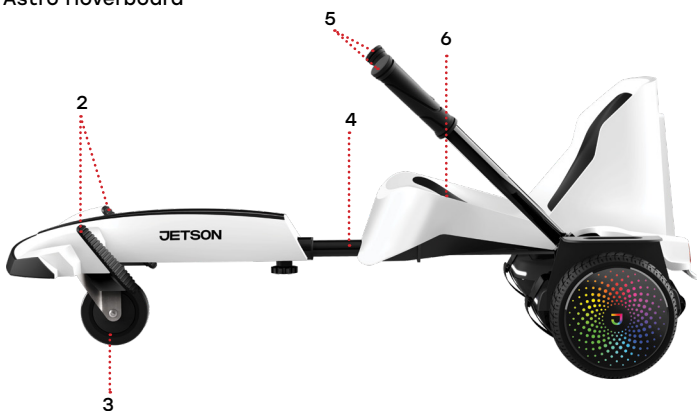

2. Foot Rest

3. Front Wheel

4. Frame Tube

5. Handlebar

6. Seat



A(x4)



B(x6)



C(x4)

Specs & Features

ASTRO

- Weight Limit: 220 lb
- Product Weight: 18 lb
- Product Dimensions: 24.5" x 8" x 7.5"
- Recommended Age: 12+
- Tire Size: 6.5"
- Max Speed: Up To 9 mph
- Max Range: Up To 12 miles
- Battery: 25.2V, 4.0 Ah Lithium-Ion
- Motor: 500W (250W*2), Dual Hub Motor
- Charger: UL Listed, 100-130V
- Charge Time: Up To 3 Hours
- Climbing Angle: Up To 15°

IMPULSE

- Weight Limit: 220 lb
- Product Weight: 16 lb
- Recommended Age: 12+
- Product Dimensions: 39" x 30" x 17.5"

1. Get Started

1.1 Charging the Battery

- Only use the included charger
- Plug the charger into the wall before the Charging Port
- Don't turn on the Astro while it's charging
- Charge the battery until it is fully charged - up to 3 hours
- Replace the cover over the Charging Port when done

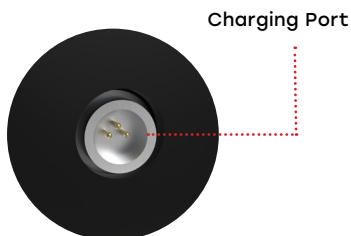



CHARGING INDICATOR ON THE CHARGER:

- - Charging
- - Charge Complete

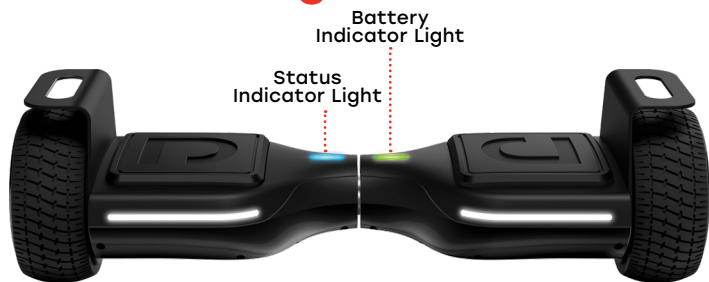
1.2 Indicator Lights



Battery Indicator Light			
Percentage	< 20%	20-49%	50% +

Warning: The Astro will automatically slow down and lean up once the battery power goes below 10% as a safety precaution.

Status Indicator Light - Lights up blue when you step onto the Astro. If the Status Indicator Light turns red or if you are having issues with the Astro, you may need to recalibrate it.

1.3 How to Recalibrate

Hold for 5 seconds

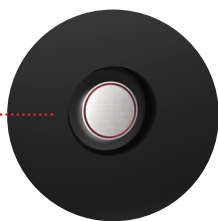



Follow these 3 simple steps...

1. Place the Astro on a flat, level surface.
2. Hold the Power Button (for about 5 seconds) until you are notified of a successful recalibration.
3. Restart the Astro by turning it off and then on.

1.4 How to Change Speed

The Astro has three speed settings & each setting has a different-colored indicator light:

-  Green for beginner (slow) mode
-  Yellow for intermediate (medium) mode
-  Red for advanced (fast) mode

Please Note: The default setting is advanced (fast) mode.

Follow these 3 simple steps...

1. Place the Astro on a flat, level surface.
2. Power the Astro on—the indicator light will illuminate red for advanced (fast) mode.
3. Quickly press and release the power button to cycle through the speed modes. Stop once the indicator light changes to the respective color of your desired speed.

Please Note: When you turn off the Astro, it will return to the original factory setting—advanced (fast) mode.

1.5 Connecting to Bluetooth®

The Astro comes equipped with two Bluetooth® modules - one for the Bluetooth® speaker and one for the Ride Jetson app.

To connect to your Bluetooth® speaker:

- Turn on the Astro, and it will become discoverable to your handheld device.
- Activate your Bluetooth® in your handheld device's settings.
- Find the Astro in your handheld device's list and select it.
- Now you can play your music.

*Adults must assist children in the initial assembly and adjustment procedures to fold/unfold product and adjust handlebars.

To connect to the Ride Jetson app:

- Open the Ride Jetson app on your handheld device.
- Tap the Bluetooth® symbol in the top left corner of the app.
- Select your Astro. Default password is 000000.

(To customize your password go to Settings in the App. If you forget your new password, you can factory reset the Astro by recalibrating)

- You should now be connected to the Astro!

MODE SETTINGS

In the Ride Jetson app you can choose from three settings:

- **Beginner Mode Max Speed:** Up to 5 mph
- **Intermediate Mode Max Speed:** Up to 7 mph
- **Advanced Mode Max Speed:** Up to 9 mph

NOTE: Other features that can be adjusted include Steering Sensitivity, Driving Force, and Auto Shutdown Time.

2. Assembly

2.1 Assembling the Handles

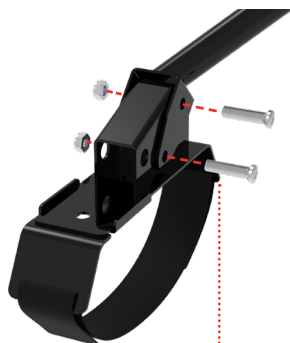

Attach the handle to the bracket using **A**(x2) and **B**(x2).

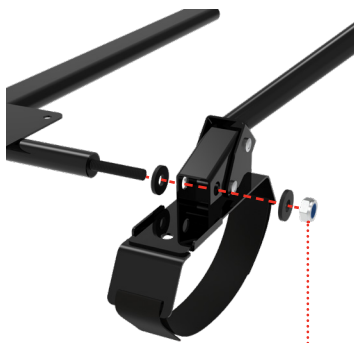

Then, attach to the frame using **B**(x1) and **C**(x2). Remember to do this on both sides of the Impulse.

2.2 Adjusting the Foot Rest

Tighten the bolt and lock nut before each ride.



Adjust to preferred length and tighten knob.

2.3 Attaching the Impulse

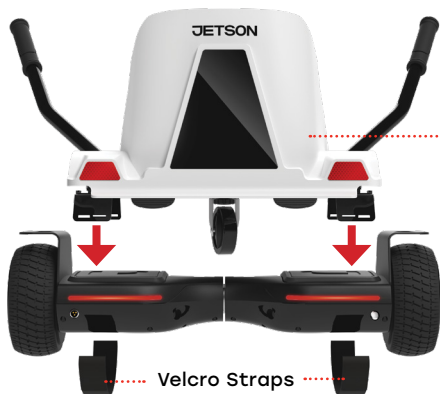

Place the Impulse on top of the Astro.

Velcro Straps

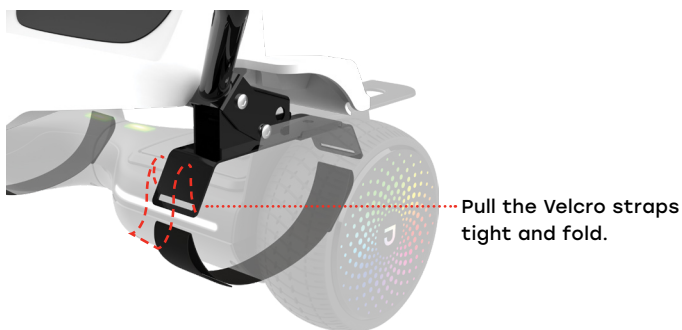

3. Make Moves

3.1 Riding the Astro

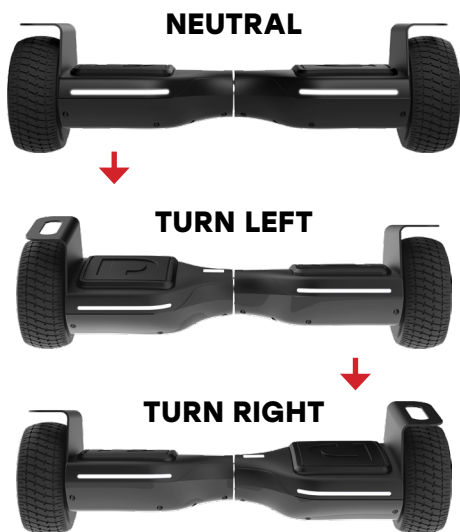

3.2 Riding the Impulse

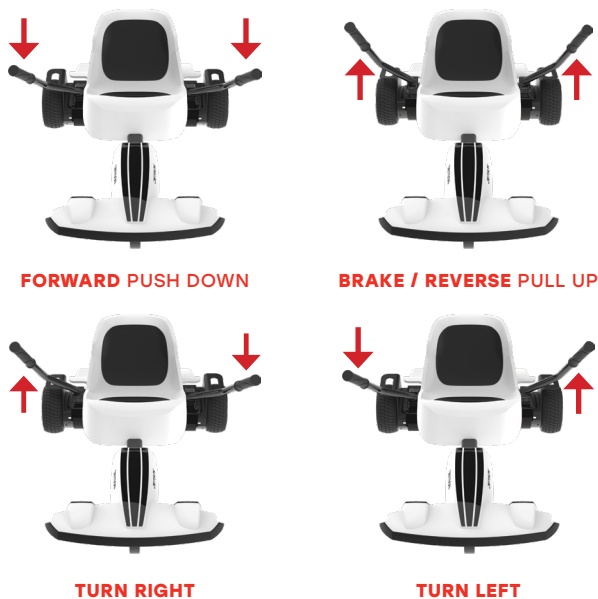

1. Place the Impulse on a flat surface with the Astro turned off.
2. Carefully take a seat and place your feet on the Foot Rest.
3. Make sure the Astro is leveled.
4. Now it's time to turn on your Astro.

Note: If the Astro is not leveled when you turn it on, the Impulse will go forward or backward immediately. Tighten all screws and locking nuts before each ride to ensure they are tight.

Please Note: Images may not reflect exact appearance of actual product.

Care & Maintenance

CLEANING THE IMPULSE

To clean the Impulse, carefully wipe with a damp cloth, then dry with a dry cloth. Do not use water to clean the Impulse, this may damage the frame or seat.

STORAGE

- Store the Impulse indoors, in a dry place.
- To protect against dust, cover the Impulse.

FEW MUST-DO'S

- Keep away from fire and excessive heat.
- Avoid intense physical shock, severe vibration, or impact.
- Please ride the Impulse on a smooth, flat surface.
- Protect from water or moisture.
- Contact Jetson Customer Support if there are any issues with the Impulse.

RIDING RANGE

The maximum range is 12 miles. However, many factors will affect how far you can go per charge:

- Driving Surface: A smooth, flat surface will increase driving distance.
- Weight: More weight means less distance.
- Temperature: Ride, store, and charge the Astro above 50°F.
- Maintenance: Timely battery charging will increase driving distance.
- Riding Style: Frequent starting and stopping will reduce driving distance.

CLEANING THE ASTRO

To clean the Astro, carefully wipe with a damp cloth, then dry with a dry cloth. Do not use water to clean the Astro, as the electrical and electronic systems may get wet, resulting in personal injury or malfunction of the Astro. If the electric parts or battery get wet, do not power on the Astro. Please contact Jetson Customer Support for assistance.

BATTERY

- Keep away from fire and excessive heat.
- Avoid intense physical shock, severe vibration, or impact.
- Protect from water or moisture.
- Do not disassemble the Astro or its battery.
- Contact Jetson Customer Support if there are any issues with the battery.

STORAGE

- Fully charge the battery before storing. The battery should be fully charged once a month after this.
- Cover the Astro to protect against dust.
- Store the Astro indoors, in a dry place.

MODIFICATIONS

Do not attempt to disassemble, modify, repair, or replace the unit or any components of the unit without instruction from Jetson Customer Support. This will void any warranty, and can lead to malfunctions which may cause injury.

ADDITIONAL OPERATION CAUTIONS

Do not lift the product off the ground while it is on and the wheels are in motion. This can result in freely spinning wheels, which may cause injury to yourself or others nearby. Do not jump on or off the product, and do not jump while using it. Always keep your feet firmly planted on the foot rest while in operation. Always check the battery charge before using.

The Bluetooth® word mark and logos are registered trademarks owned by the Bluetooth SIG, inc. And any use of such marks by Jetson Electric Bike LLC. is under license. Other trademarks and trade names are those of their respective owners.

DISPOSAL OF USED BATTERY



Battery may contain hazardous substances which could endanger the environment and human health. This symbol marked on the battery and/or packaging indicates that used battery shall not be treated as municipal waste. Batteries should be disposed of at an appropriate collection point for recycling. By ensuring the used batteries are disposed of correctly, you will help preventing potential negative consequences for the environment and human health. The recycling of materials will help to conserve natural resources. For more information about recycling of used batteries, please contact your local municipality waste disposal service.

Safety Warnings

- Before use, please read the user manual and safety warnings carefully, and make sure you understand and accept all the safety instructions. The user will be responsible for any loss or damage caused by improper use.
- Before each cycle of operation, the operator shall perform the preoperation checks specified by the manufacturer: That all guards and pads originally supplied by the manufacturer are in proper place and in serviceable condition; That the braking system is functioning properly; That any and all axle guards, chain guards, or other covers or guards supplied by the manufacturer are in place and in serviceable condition; That tires are in good condition, inflated properly, and have sufficient tread remaining; The area that the product is to be operated should be safe and suitable for safe operation.
- Components shall be maintained and repaired in accordance with the manufacturer's specifications and using only the manufacturer's authorized replacement parts with installation performed by dealers or other skilled persons.
- Warning against recharging non-rechargeable batteries.
- Don't allow hands, feet, hair, body parts, clothing, or similar articles to come in contact with moving parts, wheels, or drive train, while the motor is running.
- This product should not be used by children or persons with reduced physical, sensory or mental capabilities, or lack of experience and knowledge, unless they have been given supervision or instruction (IEC 60335-1/A2:2006).
- Unsupervised children should not play with the product (IEC 60335-1/A2:2006).
- Adult supervision is required.
- The rider should not exceed 220 lb.
- Units shall not be operated to perform racing, stunt riding, or other maneuvers, which may cause loss of control, or may cause uncontrolled operator/passenger actions or reactions.
- Never use near motor vehicles.
- Avoid sharp bumps, drainage grates, and sudden surface changes. Scooter may suddenly stop.
- Avoid streets and surfaces with water, sand, gravel, dirt, leaves, and other debris. Wet weather impairs traction, braking, and visibility.
- Avoid riding around flammable gas, steam, liquid, or dust that could cause fire.
- Operators shall adhere to all of the manufacturer's recommendations and instructions, as well as comply with all laws and ordinances: Units without headlights shall be operated only with adequate daylight conditions of visibility, and; Owners shall be encouraged to highlight (for conspicuity) using lighting, reflectors, and for low-riding units, signal flags on flexible poles.
- Persons with the following conditions shall be cautioned not to operate: Those with heart conditions; Pregnant women; Persons with head, back, or neck ailments, or prior surgeries to those areas of the body; and persons with any mental or physical conditions that may make them susceptible to injury or impair their physical dexterity or mental capabilities to recognize, understand, and perform all of the safety instructions and to be able to assume the hazards inherent in unit use.
- Do not ride at night.
- Do not ride after drinking or taking prescription medication.
- Do not carry items when riding.
- Never operate the product barefooted.
- Always wear shoes and keep shoelaces tied.
- Make sure your feet are always placed securely on the deck.
- Operators always shall use appropriate protective clothing, including but not limited to a helmet, with appropriate certification, and any other equipment recommended by the manufacturer: Always wear protective equipment such as helmet, knee pads, and elbow pads.
- Always give way to pedestrians.
- Be alert to things in front and far away from you.
- Do not allow distractions when riding, such as answering the phone or engaging in any other activities.
- The product cannot be ridden by more than one person.
- When you ride the product along with other riders, always keep a safe distance to avoid a collision.
- When turning, be sure to maintain your balance.
- Riding with improperly adjusted brakes is dangerous and can result in serious injury or death.
- The brake may become hot while operating, do not touch the brake with your bare skin.
- Applying brakes too hard or too suddenly can lock up a wheel, which could cause you to lose control and fall. Sudden or excessive application of the brake may result in injury or death.
- If the brake loosens, please adjust with the hexagon wrench, or please contact Jetson Customer Support.
- Replace worn or broken parts immediately.
- Check whether all safety labels are in place and understood before riding.
- The owner shall allow the use and operation of the unit after a demonstration that such operators can understand and operate all components of the unit before use.
- Do not ride without proper training. Do not ride at high speeds, on uneven terrain, or on slopes. Do not perform stunts or turn abruptly.
- Recommended for indoor use.
- Prolonged exposure to UV rays, rain and the elements may damage the enclosure materials, store indoors when not in use.

California Proposition 65

WARNING:

This product can expose you to a chemical such as Cadmium that is known to the state of California to cause cancer or birth defects or other reproductive harm. For more information go to www.p65warnings.ca.gov/product

NOTICE OF COMPLIANCE

This device complies with Part 15 of the FCC Rules. Operation is subject to the following two conditions: (1) this device may not cause harmful interference, and (2) this device must accept any interference received, including interference that may cause undesired operation.

Warning: Changes or modifications to this unit not expressly approved by the party responsible for compliance could void the user's authority to operate the equipment.

NOTE: This equipment has been tested and found to comply with the limits for a Class B digital device, pursuant to Part 15 of the FCC Rules. These limits are designed to provide reasonable protection against harmful interference in a residential installation. This equipment generates, uses and can radiate radio frequency energy and, if not installed and used in accordance with the instructions, may cause harmful interference to radio communications. However, there is no guarantee that interference will not occur in a particular installation. If this equipment does cause harmful interference to radio or television reception, which can be determined by turning the equipment off and on, the user is encouraged to try to correct the interference by one or more of the following measures:

- Reorient or relocate the receiving antenna.
- Increase the separation between the equipment and receiver.
- Connect the equipment into an outlet on a circuit different from that to which the receiver is connected.
- Consult the dealer or an experienced radio/ TV technician for help.

Shielded cables must be used with this unit to ensure compliance with the Class B FCC limits.

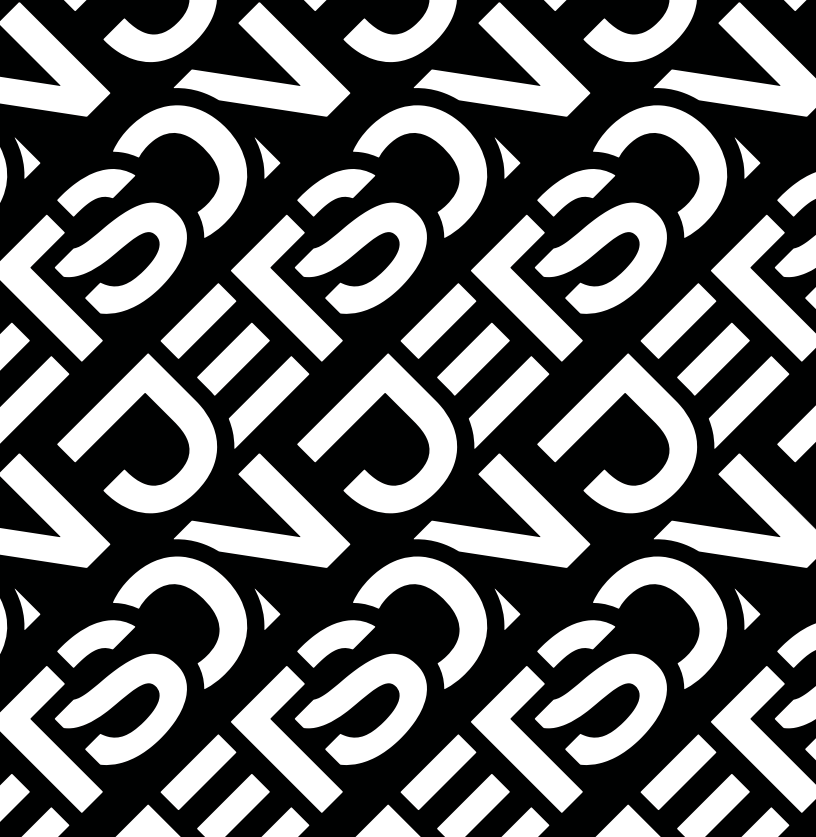

Enjoying the ride?

Leave a review on ridejetson.com/reviews or share your photos with us online using the #RideJetson hashtag!

Questions? Let us know.

support.ridejetson.com

Hours of Operation: 7 Days a Week, 10am-6pm
US 1-(888) 976-9904 | UK +44 (0)33 0838 2551

www.ridejetson.com



Follow us @ridejetson
#MakeMoves



Imported by Jetson Electric Bikes LLC.
86 34th Street 4th Floor, Brooklyn NY 11232



Date Code: 08/2020
Made in China