



Thule Smart Panels

Thule Rain Blocker G2 - Side Panel - Van

Fiat Ducato > 2006

Peugeot Boxer > 2006

Citroën Jumper > 2006

VW Crafter > 2017

> Instructions

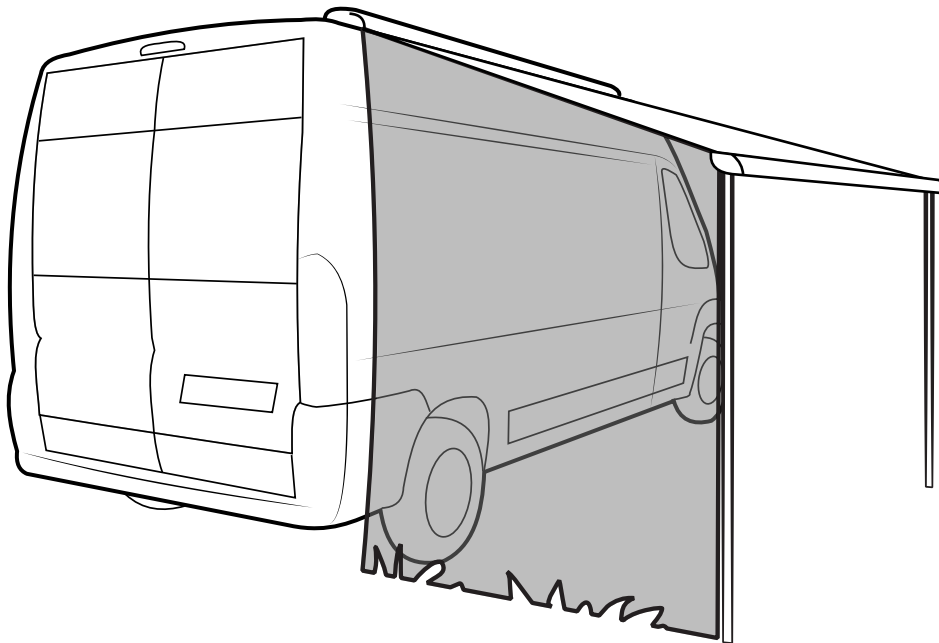

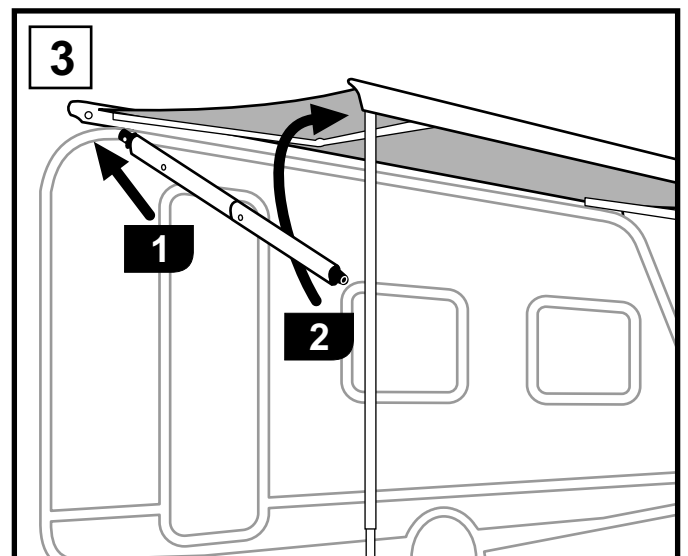
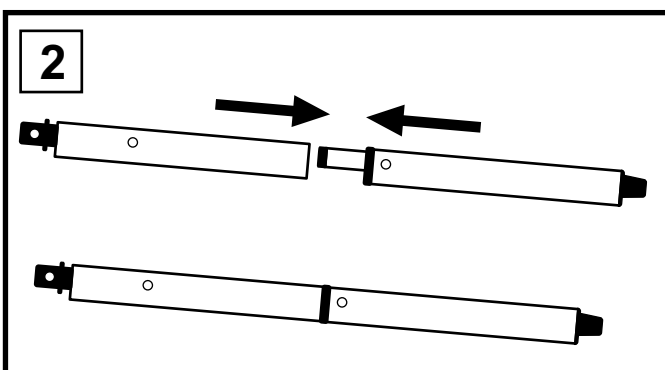
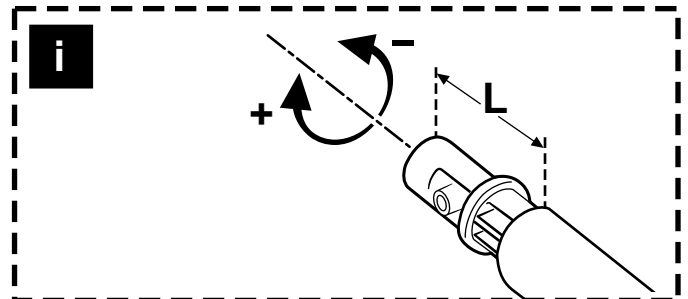
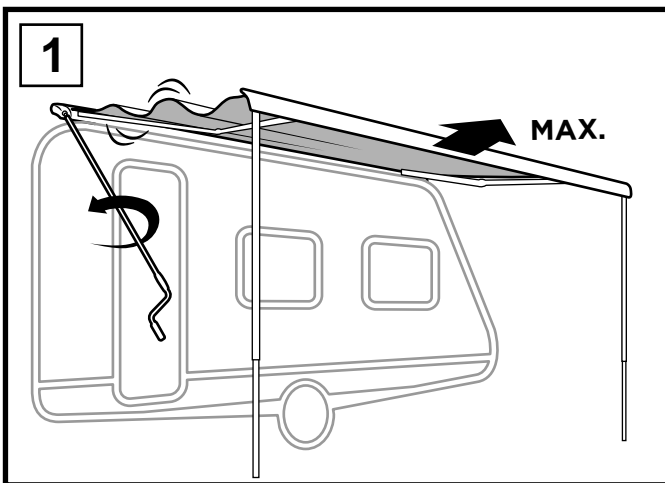
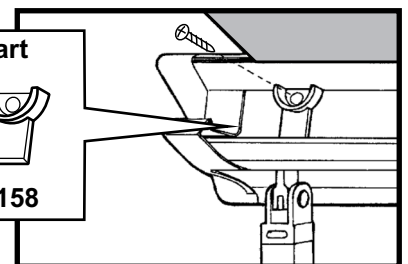
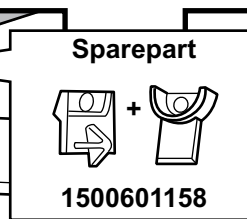
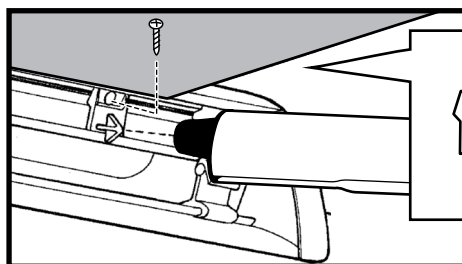
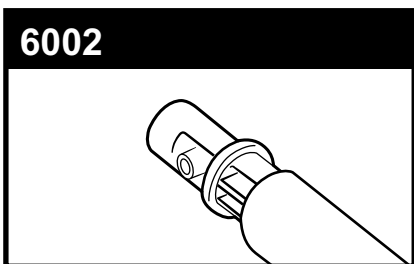
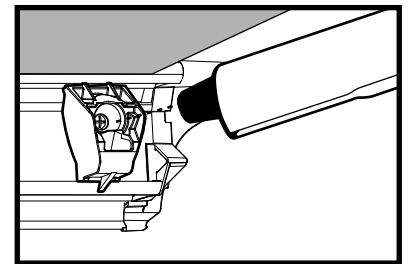
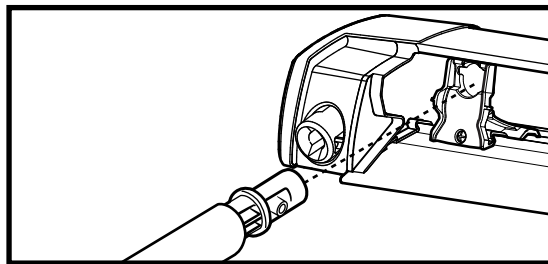
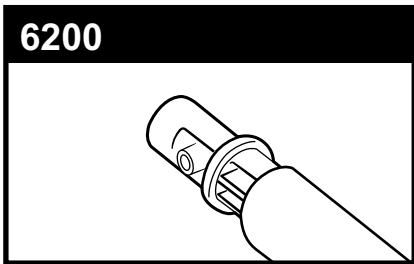
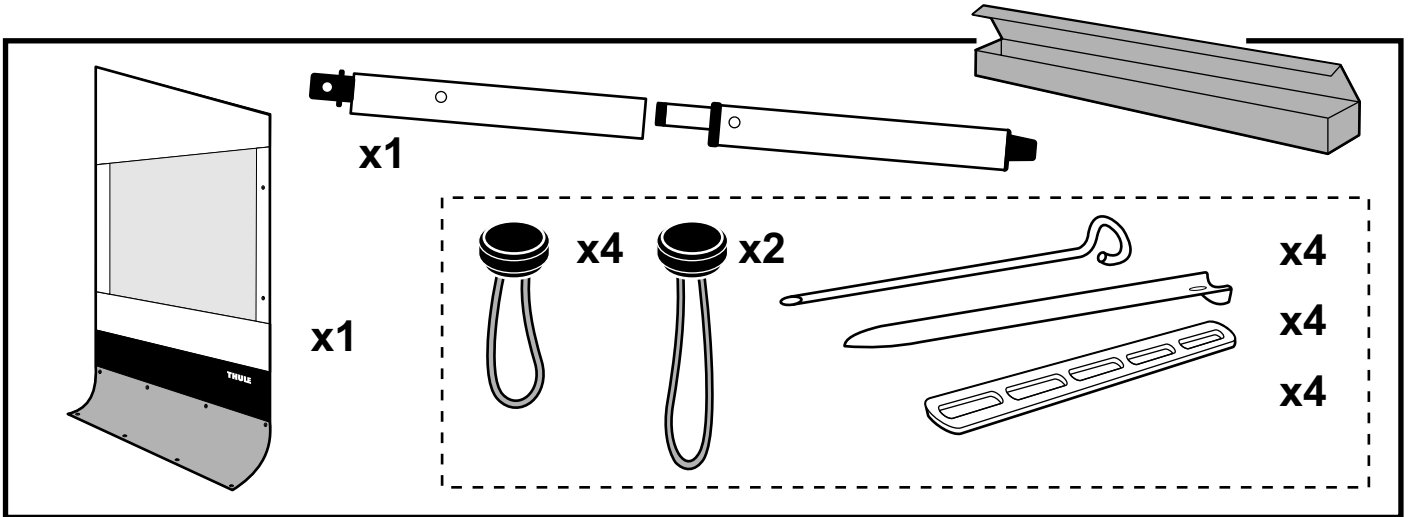

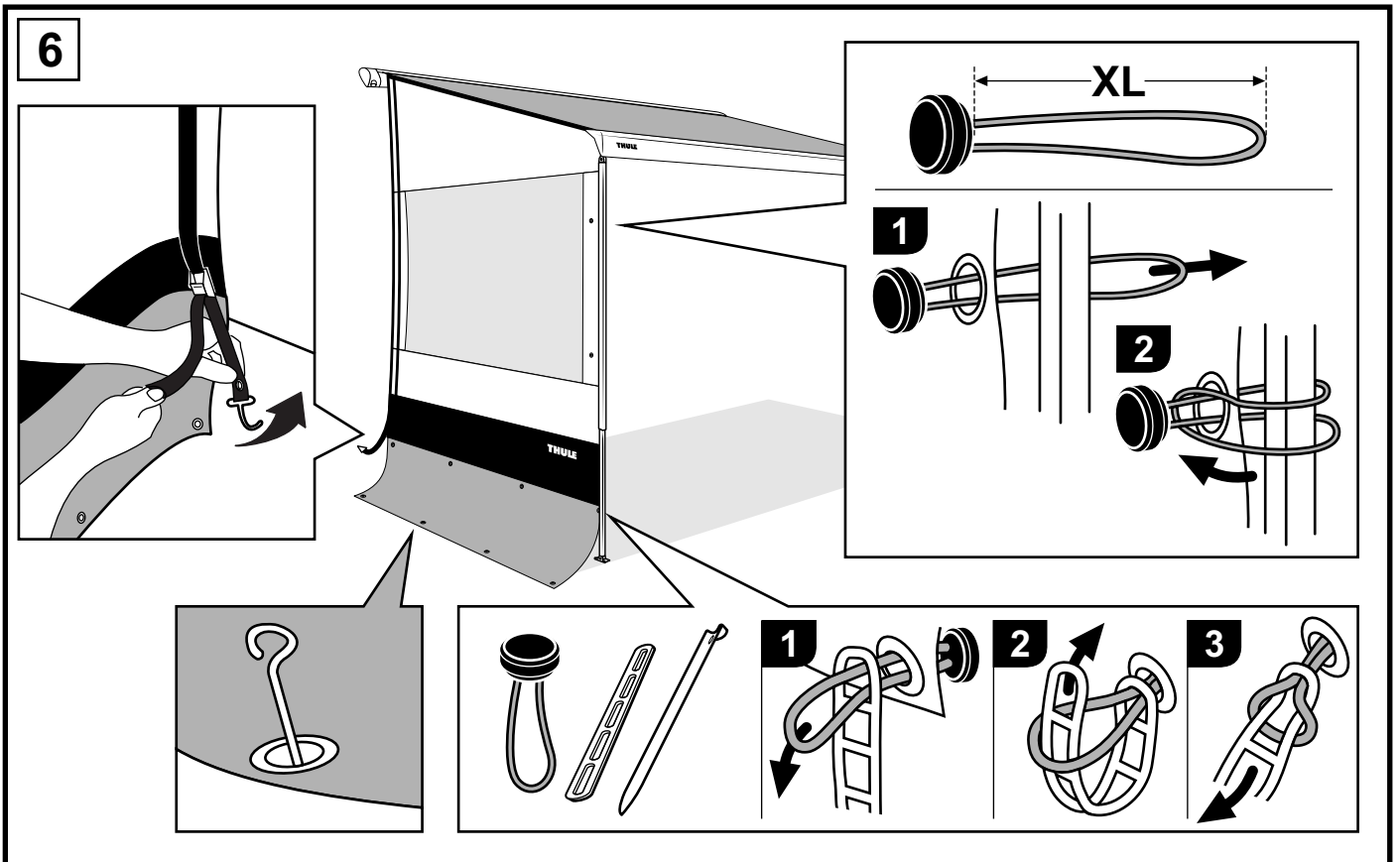
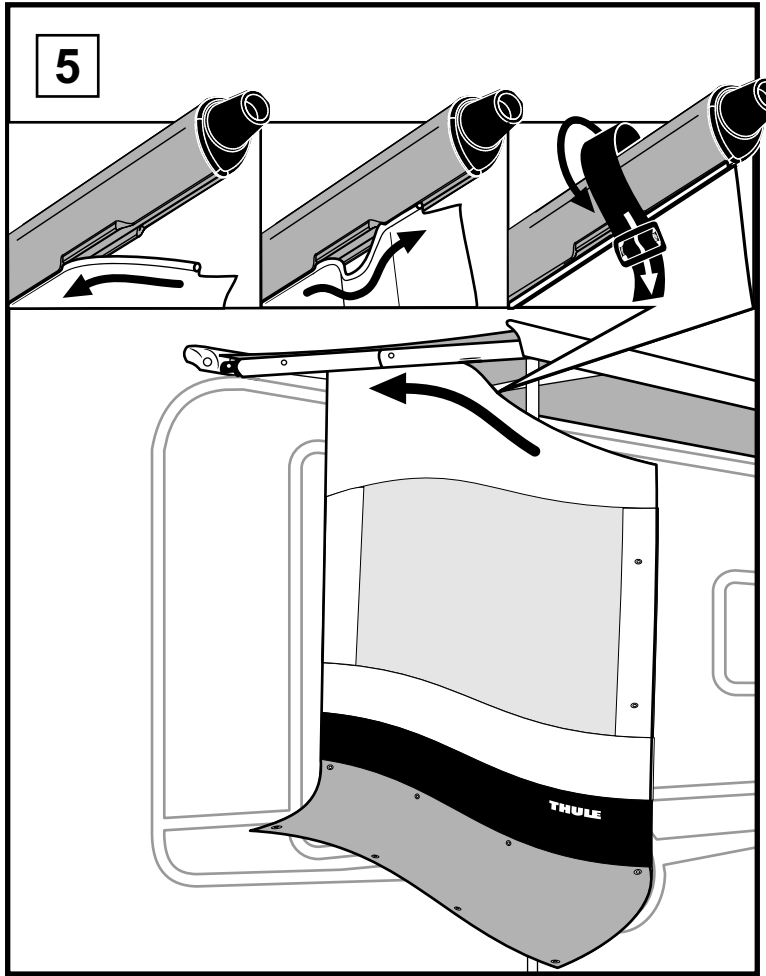
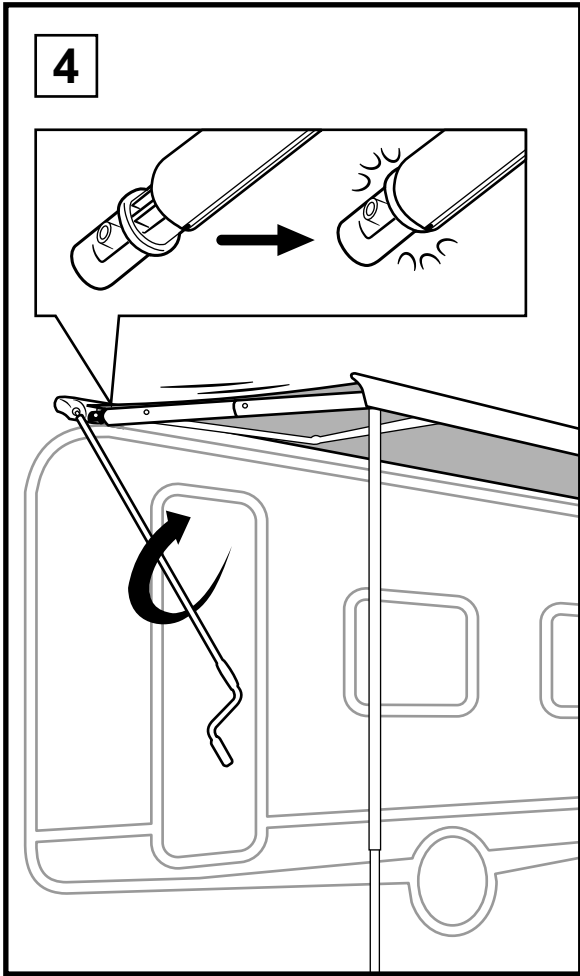

Smart Panels: some possible combinations

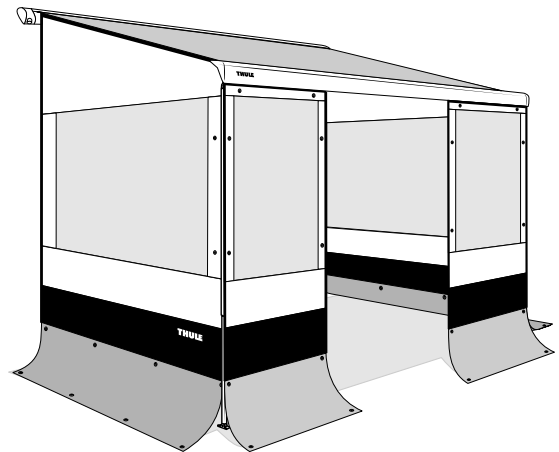
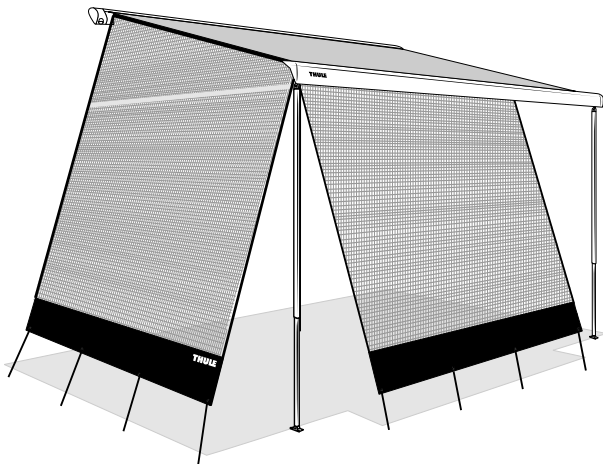
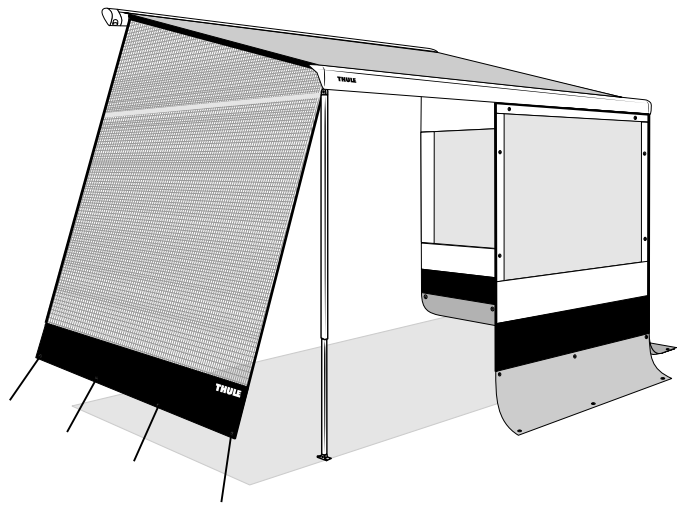
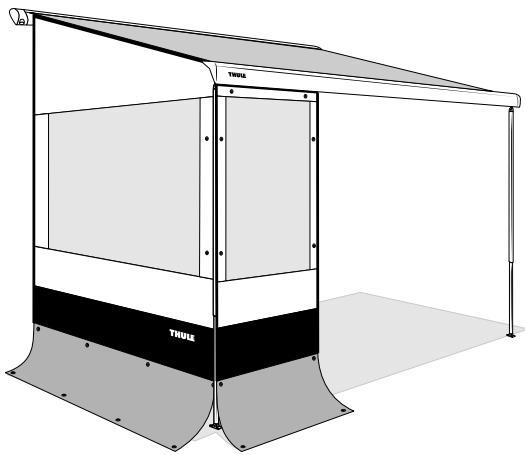
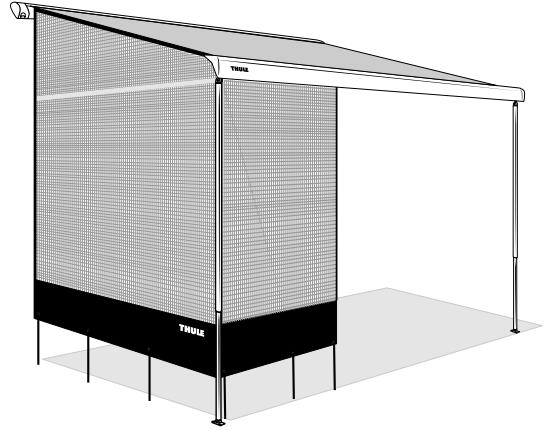
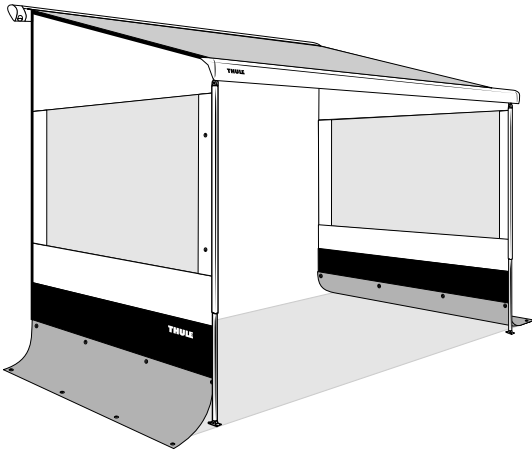

Front

Thule Sun Blocker G2
Thule Rain Blocker G2

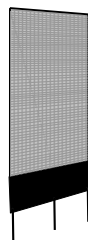
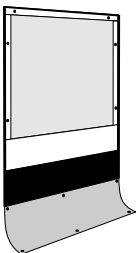

Side

Thule Sun Blocker G2
Thule Rain Blocker G2

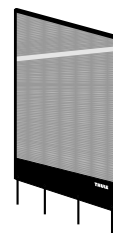
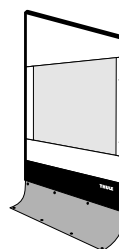

Smart Panels: some possible combinations

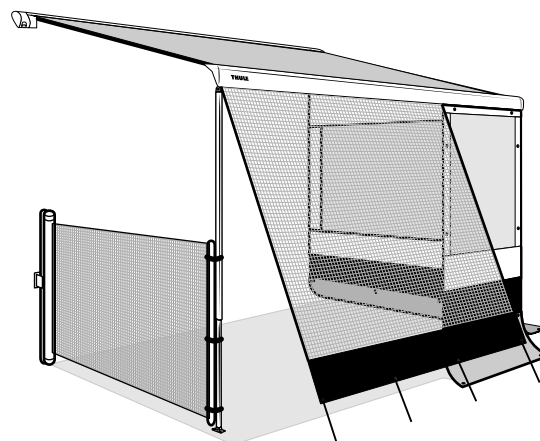
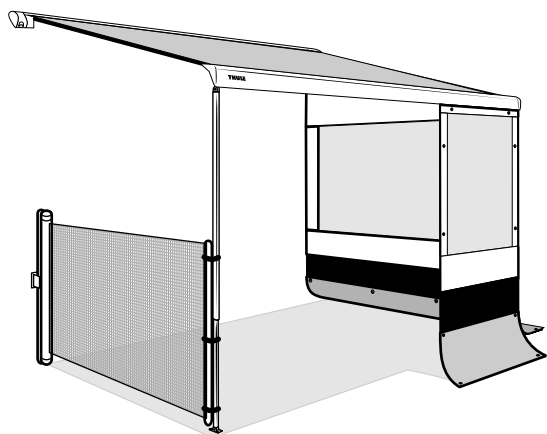

www.thule.com

306456

Thule Windscreen

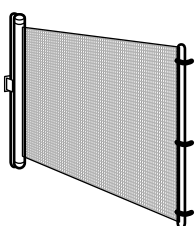

Tent

Thule QuickFit

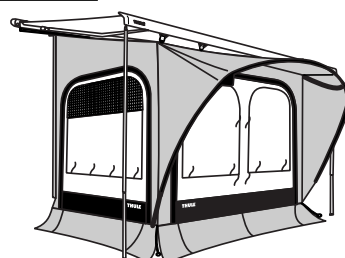

Thule Rain Blocker Front G2

Available models

MINIVAN

A

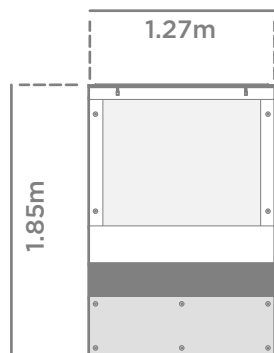

306454

S / TO1200 V2

B

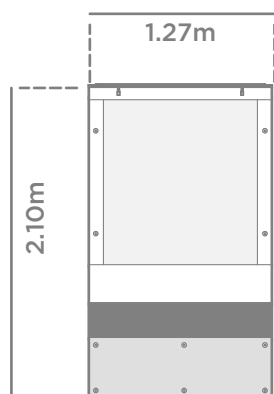

301320

C

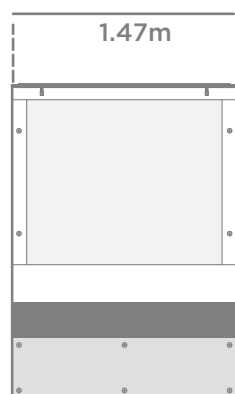

301321

D

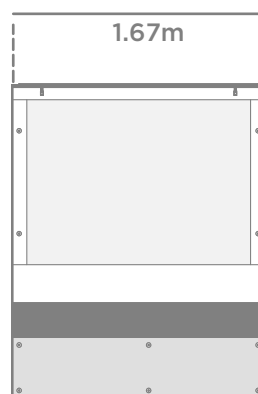

301322

E

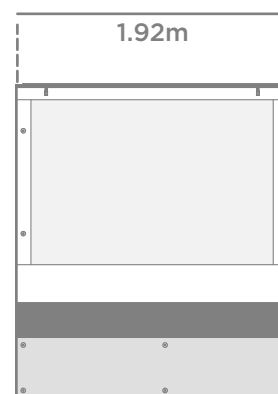

301323

M / L / XL / XXL / VAN ←

F

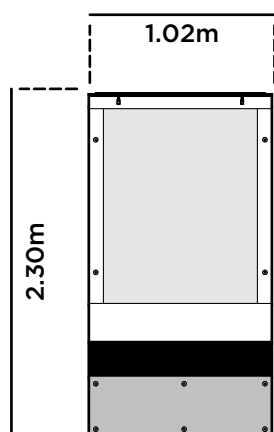

307303

G

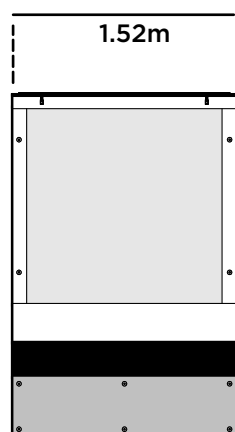

307304

H

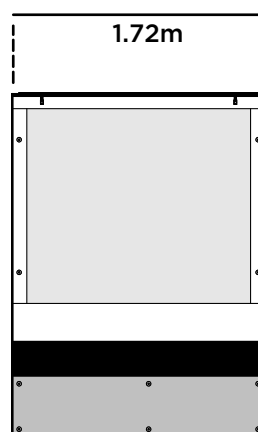

307305

I

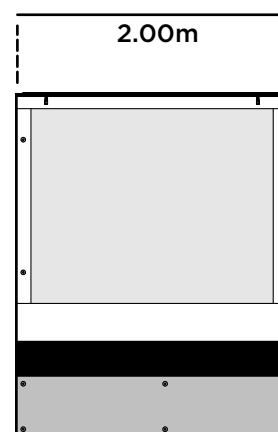

307306

Thule Rain Blocker Front G2

Combinations for full awning length

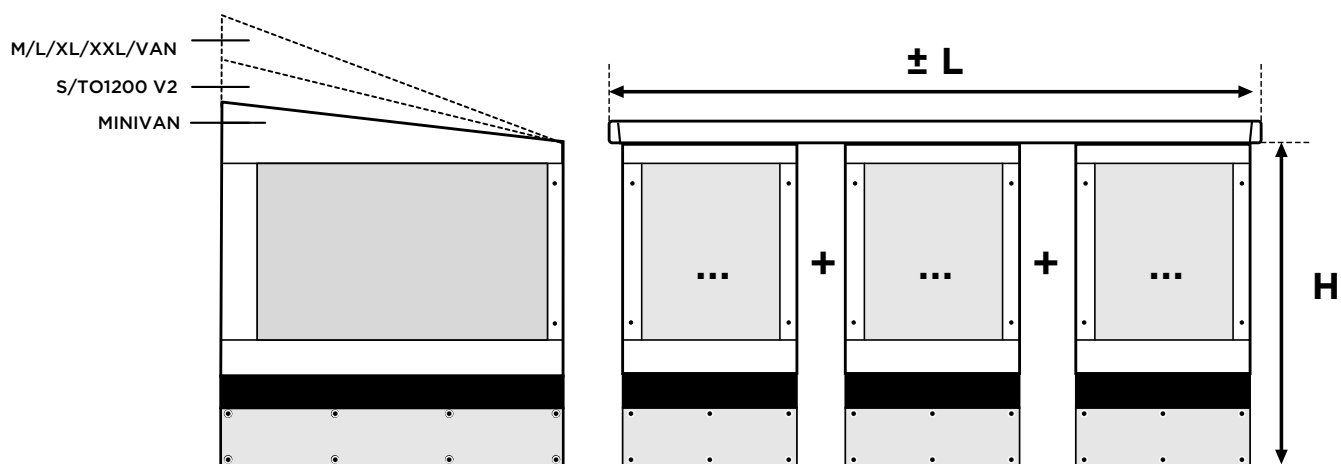

COMPATIBLE SIDE PANEL	AWNING LENGTH (L)	FRONT COMBINATION
M L XL XXL → VAN	3.00m	F + F + F
	3.25m	G + H
	3.50m	F + G + F
	3.75m	H + I
	4.00m	F + I + F
	4.25m	F + G + H
	4.50m	F + I + G
	5.00m	G + I + G
	5.50m	I + G + I
	6.00m	I + I + I

EN

Read the instructions carefully. Wrong installation, use or repair voided warranty. If recovery is needed, consult a dealer.

General remarks

- Check if the supplied product suits the type, height, and the projection of the canopy.
- The sun can affect colors depending on usage.
- When it rains, put one side of the awning lower so that the water can drain.
- When wind reaches 6 Bft. please store the panels and close the awning.
- Don't place heat sources near the walls or the roof.
- Before installing the smart panel, make sure that the vehicle wall and the panel are clean. Any sand, dust or dirt could damage your vehicle. When installed during a longer period, also clean them in between. Tip: apply foil on the vehicle to avoid scratches.

Maintenance

- Ensure that there are no hard objects on the window during folding. This is to prevent impressions.
- Let the panel dry thoroughly before long time storage.
- Use pure water or a dry brush to clean the tent.

NL

Lees deze montage instructies aandachtig. Bij verkeerde montage, gebruik of eigenhandig herstel vervalt elke aanspraak op garantie. Indien herstel nodig is, raadpleeg een Dealer.

Algemene opmerkingen

- Controleer vooraf of het geleverde product past bij het type, de hoogte en de uitval van de luifel.
- De zon kan kleuren aantasten afhankelijk van het gebruik.
- Zet bij regen één kant van de luifel wat lager zodat het water kan aflopen.
- Vanaf windkracht 6 Bft. gelieve de panelen op te bergen en uw luifel te sluiten.
- Geen warmtebronnen in de buurt van de wanden of het dak plaatsen.
- Kijk vóór het plaatsen van de smart panel of de voertuig wand en het paneel proper zijn. Zand, stof of vuil zou schade kunnen veroorzaken aan uw voertuig. Bij langdurige opstelling ook tussentijds reinigen. Tip: breng een folie op het voertuig aan om krassen te voorkomen.

Onderhoud

- Zorg ervoor dat er geen harde voorwerpen op de ruit liggen tijdens het opvouwen. Dit om afdrucken te voorkomen.
- Laat de panelen goed drogen alvorens op te bergen voor langere tijd.
- Gebruik zuiver water of een droge borstel om de panelen te reinigen.

DE

Bitte lesen Sie die Montagevorschriften gründlich durch. Bei verkehrter Montage oder Änderung des Produkts entfallen alle Garantieansprüche. Im Falle von Reparaturen wenden Sie sich bitte an Ihren Fachhändler.

Allgemeine Bemerkungen

- Überprüfen Sie dass das gelieferte Produkt korrespondiert mit dem Markisentyp, Höhe und Auszug.
- Die Sonne kann Farben beeinflussen je nach Gebrauch
- Stellen Sie die Markise schräg für einen besseren Wasserablauf.
- Ab Windstärke 6 : das Produkt abbauen und die Markise einfahren.
- Keine Wärmequellen in der Nähe der Wände oder das Dach setzen.
- Vor der Montage, bitte kontrollieren dass die Seitenwände des Fahrzeugs und die Seitenwand gesäubert sind. Sand, Staub oder Verschmutzungen können Schaden verursachen am Fahrzeug. Beim längeren Gebrauch bitte auch zwischenzeitlich säubern. Tipp: Tragen Sie eine Folie auf das Fahrzeug auf, um Kratzer zu vermeiden.

Unterhalt

- Vermeiden Sie beim Falten dass sich keine harten Gegenstände oder Schmutz mit einrollen. Es kann Abdrücke verursachen auf die Fensterfolie.
- Lassen Sie den Wand gut austrocknen vor dem zusammenfallen für längere Zeit.
- Benützen Sie nur sauberes Wasser und eine trockene weiche Bürste um das Produkt zu reinigen.

FR

Lisez attentivement les notices d'installation. Une mauvaise installation, utilisation ou propre réparation annule toute garantie. Si la réparation est nécessaire veuillez consulter votre revendeur.

Remarques générales

- Vérifiez si le panneau fourni correspond au type, hauteur et avancé du store.
- Dépendant de l'utilisation le soleil peut affecter le coloris de la toile
- Abaissez un pied de store pour obtenir un meilleur écoulement de l'eau en cas de pluie.
- À partir d'une force de vent de 6 Bft démontez le panneau et fermez le store.
- Ne placez aucune source de chaleur près des murs ou du toit.
- - Vérifiez avant installation du smart panel, que le paroi de votre véhicule et le paroi soient bien propres. Le sable, la poussière ou la saleté pourraient endommager votre véhicule. Régulièrement nettoyer en cas de montage de longue durée. Conseil: appliquez une film plastique sur le véhicule pour éviter les rayures.

Maintenance

- Assurez-vous qu'il n'y a pas d'objets extérieurs sur la fenêtre lors du repliage. Ceci afin d'éviter des encoches dans la toile.
- Laissez sécher la toile complètement avant de la ranger de longue durée.
- Utilisez de l'eau claire ou une brosse sèche pour nettoyer.