

DIRECTIONS FOR USE TEMPO TRAFIC LIGHT

tempo

A0031DD71004G-User Guide



CAUTIONS

To avoid any damage, and when the equipment will not be used for a longer period (more than a month), **disconnect the batteries and accumulators** from the yellow cupola, from the remote control and from the battery box. Periodically control the batteries used by dates.

For the handling of the traffic light, or its accessories such as the battery, the use of PPE is mandatory (gloves, glasses and safety shoes).



POWER ON



Display when switched on



In order to become familiar with the programming procedure, it is advisable to test the configuration of the lights in the workshop, before putting them into service on site.

- Turn on the Tempo traffic lights by connecting the switch placed in the battery box.
- At that time, the Tempo traffic light is in a waiting state « central orange light flashing ».

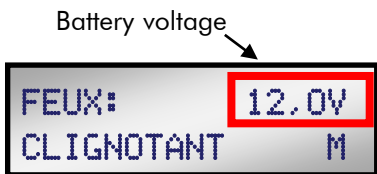

CONTROL MANAGEMENT

Control Management with remote control



Selection of the different modes by successive pression on the + ou - (mode) user-defined keys.



- Fixed cycle
- Uneven traffic
- Free cycle
- Crossroad 3T
- Crossroad 3X
- Crossroad 4T
- Crossroad 4X

**The setting of the various user modes described in this manual always starts with the same step.*

FORCING MODES

Control Management with pushing button

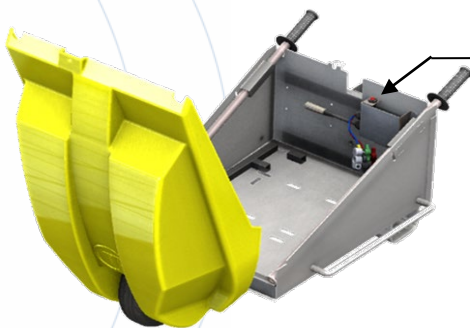

Selection of the different modes by successive pression on the button

- Flashing orange
- Stand by
- Red only
- Fixed cycle when traffic light is programmed otherwise « not synchronized » displayed

RESET

Press down the push button for 5 seconds without disconnecting the battery.

SWITCH OFF

By the switch and press down the push button for 5 seconds.

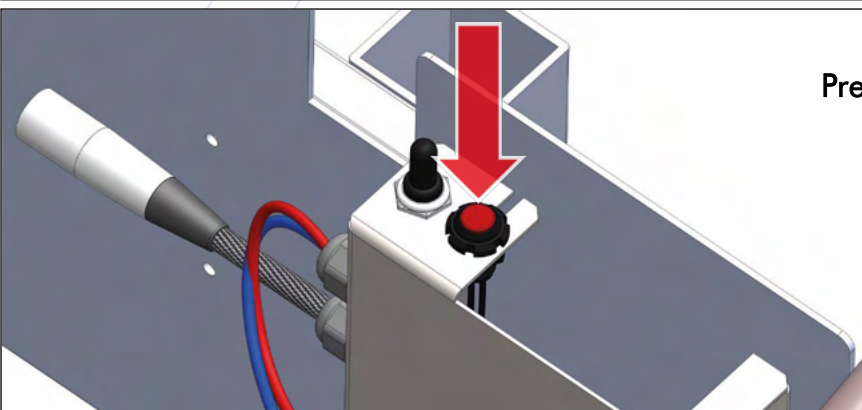

2 LIGHTS ALTERNATING PROGRAMMING - BALANCED TRAFFIC

	Traffic Length	100m	200m	300m	400m	500m	600m
	Full RED	12''	22''	32 ''	42''	52''	62''
Low Traffic (2000 cars/jour)	Yellow	20''	20''	20''	24''	28''	32''
Medium Traffic (2 to 5000 cars/jour)	Yellow	30''	30''	36''	46''	54''	62''
Heavy Traffic (5 to 8000 cars/jour)	Yellow	44''	66''	90''	112''	130''	150''
Very Heavy Traffic (8 to 11000 cars/jour)	Yellow	130''	150''	170''	190''	210''	230''

*Full red = Time when both lights are red.
 Waiting time = 2x full red + yellow

2 LIGHTS ALTERNATING PROGRAMMING - UNBALANCED TRAFFIC

	Length	100m	200m	300m	400m	500m	600m
	Full RED	12''	22''	32 ''	42''	52''	62''
Heavy Traffic (5 à 8000 véh./jour)	Yellow with traffic	30''	44''	58''	72''	86''	100''
	Yellow against traffic	20''	24''	32''	38''	46''	54''
Very Heavy Traffic (8 to 11000 cars/jour)	Yellow with traffic	46''	72''	98''	124''	150''	176''
	Yellow against traffic	26''	38''	50''	62''	74''	86''
Traffic Limit (11 to 14000 cars/jour)	Yellow with traffic	86''	100''	114''	132''	150''	168''
	Yellow against traffic	45''	54''	63''	72''	81''	90''



- Times are given in seconds.
- The crossed out sections represent impossible traffic combinations, in an alternating 2 lights configuration on a work site.

TTS-Tempo-2
001-V100

Battery voltage

LIGHT: 12.0V
FLASHING M

Displayed when switch on



STEP 1

Switch on

- Turn on the Tempo traffic lights by the switch placed in the battery box.
- At that time, the Tempo traffic light is in a waiting state « central orange light flashing ».

FIXED CYCLE
TRAFFIC: LOW

- ▲ LOW
- AVERAGE
- HEAVY
- ▼ VERY HEAVY



Selection



Validation

STEP 2

Traffic programming

- Switch on the remote control
- Direct it to the window display symbol ((●))
- Select the density of the traffic with the + and - (select) user-defined keys. (please refer to the time table page 3)
- Validate.

FIXED CYCLE
LENGHT: 100m

- ▲ 100m
- 200m
- 300m
- 400m
- 500m
- ▼ 600m



Selection



Validation

STEP 3

Roadwork length programming

- Select the length between the two traffic light with the + and - (select) user-defined keys. (Se référer au tableau des temps page3)
- Validate.

You must hear a double BEEP.



FIXED CYCLE 12.0V
100m LOW m

Traffic light1

Traffic light2

FIXED CYCLE 12.0V
100m LOW a



Validation



STEP 4

Validation of the cycle on the 2nd traffic light

- Go to the 2nd traffic light
- Direct the remote control to the window display symbol ((●))
- Validate.

You must hear a double BEEP.



SWITCH OFF

- By the switch and maintain pression on the button during 5 seconds until the LCD screen goes off.

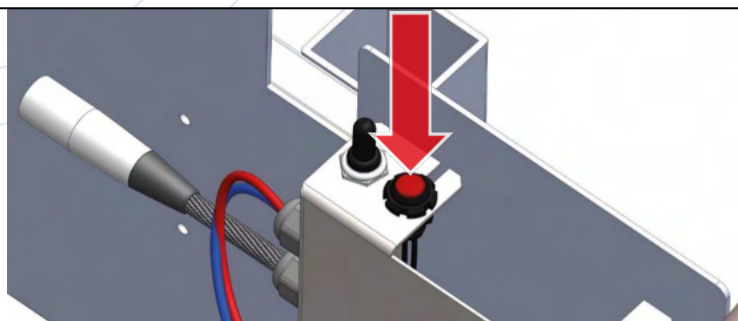

➔ Traffic is more important on a traffic axis.

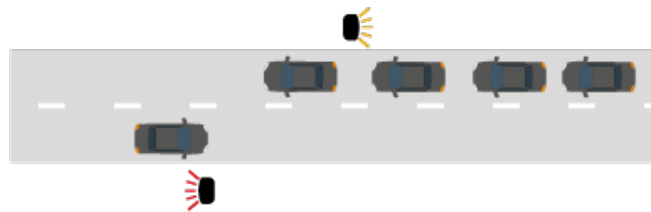

STEP 1 Mode selection

LIGHT: 12.0V
FLASHING M

CYCLE:
UNEVEN



Selection



Validation

- Switch on the remote control
- Direct it to the window display symbol ((●))
- Select « Uneven » mode with the + and - (mode) user-defined keys.
- **Validate.**

STEP 2

One side heavy traffic programming

The traffic load setting is done on the 1st light:
LOAD + : Light 1 - for more dense traffic.
LOAD - : Light 1 - for less dense traffic.

DIRECTION
TRAFFIC:LOAD

▲ LOAD +

▼ LOAD -



Selection



Validation

- Select if the traffic is more or less heavy on this side with + and - (select) user-defined keys.
- **Validate.**

STEP 3

Traffic programming

■ Select the uneven density of the traffic with the + and - (select) user-defined keys.
(please refer to the time table page 3)

UNEVEN
TRAFFIC:HEAVY

▲ HEAVY
VERY HEAVY

▼ LIMIT



Selection



Validation

- **Validate.**

STEP 4

Roadwork length programming

■ Select the length between the two traffic light with the + and - (select) user-defined keys.

UNEVEN
LENGHT: 100m

▲ 100m

200m

▼ 300m



Selection



Validation

- **Validate.**
You must hear a double BEEP.

STEP 5

Validation of the cycle on the 2nd traffic light

■ Go to the 2nd traffic light
■ Direct the remote control to the window display symbol ((●))

- **Validate.**
You must hear a double BEEP.

Traffic light 1
UNEVEN + 12.0V
100m HEAVY m

Traffic light 2
UNEVEN - 12.0V
100m HEAVY a



Validation

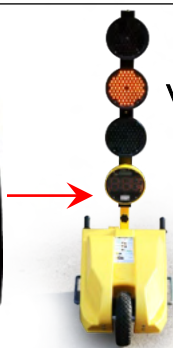

 *The passage time for each light is configurable.
The length of the site is adjustable up to 2000m.*

STEP 1 Starting mode

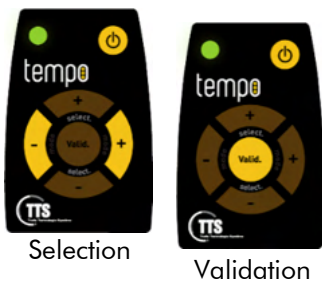
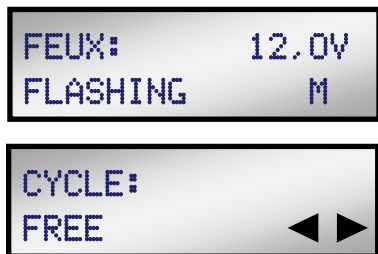

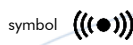
- Switch on the remote control
- Direct it to the window display symbol 
- Select « Free » mode with the + and - (mode) user-defined keys.
- **Validate.**

STEP 2 Traffic length programming

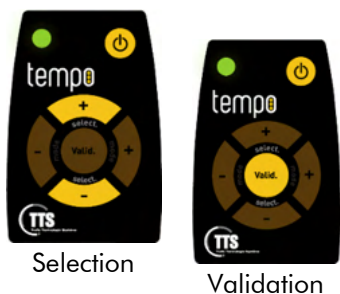
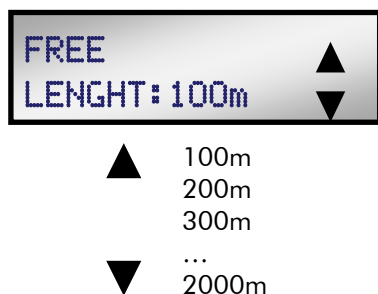

- Select the length of the roadwork using the + and - (select) user-defined keys.
- **Validate.**

STEP 3 Traffic light 1 time programming

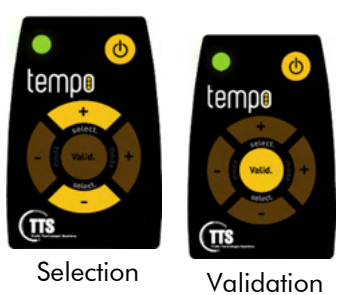
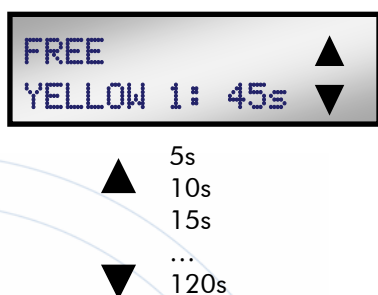

- Select the flashing time of the 1st light on the 1st traffic light using the + and - (select) user-defined keys.
- **Validate.**

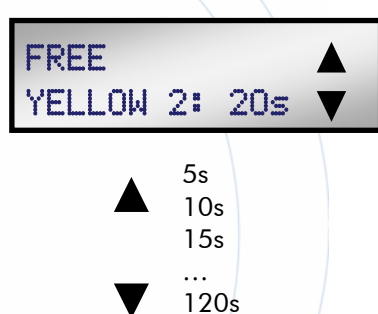

STEP 4 Traffic light 2 time programming

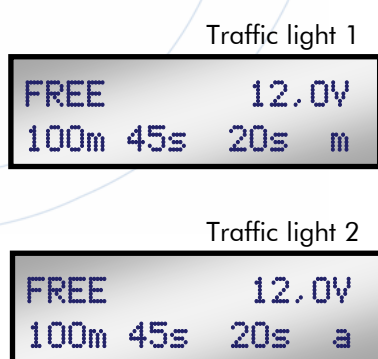

- Select the flashing time of the 2nd light on the 1st traffic light using the + and - (select) user-defined keys.
 - **Validate.**
- You must hear a double BEEP. 

STEP 5 Validation of the cycle on traffic light 2



- Go to the 2nd traffic light
 - Direct the remote control to the window display symbol 
 - **Validate.**
- You must hear a double BEEP. 

➔ Each light turns green one after the other

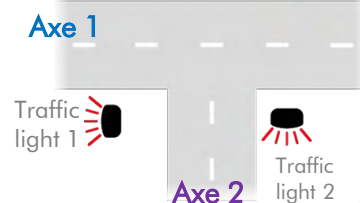

LIGHT: 12.0V
FLASHING M

CYCLE:
CROSSROAD 3T ◀▶



Selection



Validation

STEP 1 Mode selection

- Switch on the remote control
- Direct it to the window display symbol ((●))
- Select « Crossroad 3T » mode with the + and - (mode) user-defined keys.
- **Validate.**

CROSSROAD 3T
RED: 25s

- ▲ 5s
- 10s
- 15s
- ...
- ▼ 60s



Selection



Validation

STEP 2 Red light programming

- Select the redlight timing with the + and - (select) user-defined keys.
- **Validate.**

CROSSROAD 3T
GREEN 1: 10s

- ▲ 5s
- 10s
- 15s
- ...
- ▼ 60s



Selection



Validation

STEP 3 Traffic light 1 green light programming

- Select the green light timing (flashing orange) of the 1st traffic light with the + and - (select) user-defined keys.
- **Validate.**

CROSSROAD 3T
GREEN 2: 15s

- ▲ 5s
- 10s
- 15s
- ...
- ▼ 60s



Selection



Validation

STEP 4 Traffic light 2 green light programming

- Select the green light timing (flashing orange) of the 2nd traffic light with the + and - (select) user-defined keys.
- **Validate.**

Repeat this step for the light n°3.
You must hear a double BEEP.



CROSSROAD 12.0V
3T GREEN: 25s P1m

Traffic light 1

CROSSROAD 12.0V
3T GREEN: 25s P2a

Traffic light 2

CROSSROAD 12.0V
3T GREEN: 25s P3a

Traffic light 3



Validation



STEP 5 Validation of the cycle on traffic lights 2 and 3

- Go to the 2nd traffic light
 - Direct the remote control to the window display symbol ((●))
 - **Validate.**
- You must hear a double BEEP.



Repeat this operation for the third light.

➔ Lights 1 and 3 have the same color (axis 1).
Light 2 (axis2) is opposite axis 1.

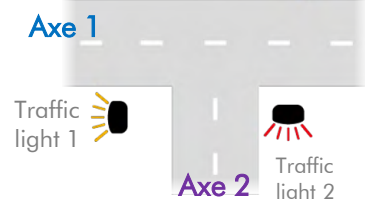

STEP 1 Mode selection

LIGHT: 12.0V
FLASHING M

CYCLE:
CROSSROAD 3X ◀▶



Selection



Validation

- Switch on the remote control
- Direct it to the window display symbol ((●))
- Select « Crossroad 3X » mode with the + and - (mode) user-defined keys.
- Validate.

STEP 2 Red light programming

CROSSROAD 3X ▲▼
RED: 25s

- ▲ 5s
- ▲ 10s
- ▲ 15s
- ▼ ...
- ▼ 60s



Selection



Validation

- Select the red light timing with the + and - (select) user-defined keys.
- Validate.

STEP 3 Axis 1 green light programming

CROSSROAD 3X ▲▼
AXE 1: 10s

- ▲ 5s
- ▲ 10s
- ▲ 15s
- ▼ ...
- ▼ 60s



Selection

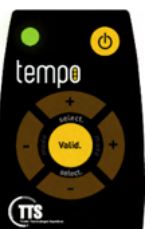

Validation

- Select the green light timing (flashing orange) of the 1st axis with the + and - (select) user-defined keys.
- Validate.

STEP 4 Axis 2 green light programming

CROSSROAD 3X ▲▼
AXE 2: 10s

- ▲ 5s
- ▲ 10s
- ▲ 15s
- ▼ ...
- ▼ 60s



Selection



Validation

- Select the green light timing (flashing orange) of the 2nd axis with the + and - (select) user-defined keys.
- Validate.

You must hear a double BEEP.



STEP 5 Validation of the cycle on traffic lights 2 and 3

CROSSROAD 12.0V
3X GREEN: 25s P1m

Traffic light 1

CROSSROAD 12.0V
3X GREEN: 25s P2a

Traffic light 2

CROSSROAD 12.0V
3X GREEN: 25s P3a

Traffic light 3



Validation



Validation of the cycle on traffic lights 2 and 3

- Go to the 2nd traffic light
- Direct the remote control to the window display symbol ((●))
- Validate.

You must hear a double BEEP.

Repeat this operation for the third light.



➔ Each light turns green one after the other

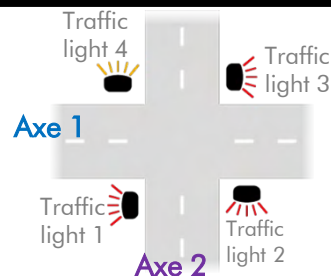

LIGHT: 12.0V
FLASHING M

CYCLE:
CROSSROAD 4T



Selection



Validation

STEP 1 Mode selection

- Switch on the remote control
- Direct it to the window display symbol ((●))
- Select « Crossroad 4T » mode with the + and - (mode) user-defined keys.
- **Validate.**

CROSSROAD 4T
RED: 25s

- ▲ 5s
- ▲ 10s
- ▲ 15s
- ▼ ...
- ▼ 60s



Selection



Validation

STEP 2 Red light programming

- Select the red light timing with the + and - (select) user-defined keys.
- **Validate.**

CROSSROAD 4T
GREEN 1: 10s

- ▲ 5s
- ▲ 10s
- ▲ 15s
- ▼ ...
- ▼ 60s



Selection



Validation

STEP 3 Traffic light 1 green light programming

- Select the green light timing (flashing orange) of the 1st traffic light with the + and - (select) user-defined keys.
- **Validate.**

CROSSROAD 4T
GREEN 2: 15s

- ▲ 5s
- ▲ 10s
- ▲ 15s
- ▼ ...
- ▼ 60s



Selection



Validation

STEP 4 Traffic light 2 green light programming

- Select the green light timing (flashing orange) of the 2nd traffic light with the + and - (select) user-defined keys.
- **Validate.**

Repeat this step for the light n°3 and n°4.

You must hear a double BEEP.



CROSSROAD 12.0V
4T GREEN: 25s P1m

Traffic light 1

CROSSROAD 12.0V
4T GREEN: 25s P2a

Traffic light 2

CROSSROAD 12.0V
4T GREEN: 25s P3a

Traffic light 3

CARREFOUR 12.0V
4T GREEN: 25s P4a

Traffic light 4



Validation



STEP 5 Validation of the cycle on traffic lights 2, 3 and 4

- Go to the 2nd traffic light
- Direct the remote control to the window display symbol ((●))
- **Validate.**

You must hear a double BEEP.



Repeat this operation for the third and fourth light.

➔ Lights 1 and 3 have the same color (axis 1)
The light 2 and 4 (axis 2) have the same color and are opposite the axis 1.

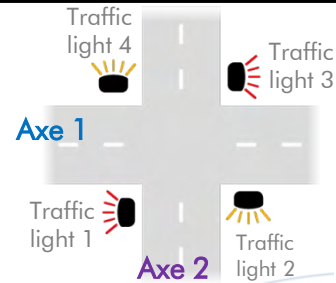

STEP 1 Mode selection

LIGHT: 12.0V
FLASHING M

CYCLE:
CROSSROAD 4X ◀ ▶



- Switch on the remote control
- Direct it to the window display symbol ((●))
- Select « Crossroad 4X » mode with the + and - (mode) user-defined keys.
- Validate.

STEP 2 Red light programming

CROSSROAD 4X ▲ ▼
RED: 25s

- ▲ 5s
- 10s
- 15s
- ▼ ...
- 60s



- Select the red light timing with the + and - (select) user-defined keys.
- Validate.

STEP 3 Axis 1 green light programming

CROSSROAD 4X ▲ ▼
AXE 1: 10s

- ▲ 5s
- 10s
- 15s
- ▼ ...
- 60s



- Select the green light timing (flashing orange) of the 1st axis with the + and - (select) user-defined keys.
- Validate.

STEP 4 Axis 2 green light programming

CROSSROAD 4X ▲ ▼
AXE 2: 20s

- ▲ 5s
- 10s
- 15s
- ▼ ...
- 60s



- Select the green light timing (flashing orange) of the 2nd axis with the + and - (select) user-defined keys.
- Validate.

You must hear a double BEEP.



STEP 5 Validation of the cycle on traffic lights 2, 3 and 4

CROSSROAD 12.0V Traffic light 1
4X GREEN: 25s P1m

CROSSROAD 12.0V Traffic light 2
4X GREEN: 25s P2a

CROSSROAD 12.0V Traffic light 3
4X GREEN: 25s P3a

CROSSROAD 12.0V Traffic light 4
4X GREEN: 25s P4a



Validation of the cycle on traffic lights 2, 3 and 4

- Go to the 2nd traffic light
- Direct the remote control to the window display symbol ((●))
- Validate.

You must hear a double BEEP.



Repeat this operation for the third and fourth light.



tempo

Tempo mobile traffic light & Tempo solar



In-stock products available within 48 h (from factory departure)

Electrical components for junction box

- 460** 3-pin XLR female base socket
- 1521** Spiral cable + 3-pin XLR socket
- 477** Red battery terminal
- 478** Green battery terminal

Tempo Solar Specific spare parts



- 4339** Solar panel 12 V 20 W
- 31125** Solar housing cover 12 V 20 W
- 31036** Solar battery holder case 12 V 20 W
- 1164** Tempo Solar wheel
- 31119** Charge regulator

Sheet metal options

- 43753** Battery carrier box OPTIMO
- 44429** Box lid partial opening before october2019
- 49678** Box cover full opening from october 2019

Since 2018 :

Before 2018 :



www.ttsys.eu

ROADWORKS SIGNALING



VEHICLE SIGNALING



ON-BOARD SIGNALING



PERMANENT SIGNALING



S.A capital : 1 088 000 € RC Grasse B 398 379 214 Siret 398 379 214 00065

Headquarters and manufacturing center
ZI Carros - 1^{ère} avenue, 2^{ème} rue - BP 594 - 06516 Carros
Tél. +33 (0)4 92 08 29 99 Fax +33 (0)4 92 08 29 90
Email : info@ttsys.fr - Human resources : rh@ttsys.fr



Made in France