

**Revolution SVR
Classic Series
Assembly
Instructions**



Before you begin

FOR QUICK & EASY
3D ASSEMBLY
INSTRUCTIONS

Step 1: Search for BILT Instructions and download the free BILT app.

Step 2: Once in the BILT app, search your Killerspin table model in the BILT app search bar.

Step 3: Begin easy assembly of this product using the BILT 3D-guided interactive instructions.

BILT[®]
Intelligent Instructions



Revolution SVR Classic Series

TABLE MODEL

Safety

1. Do not stand or sit on the table.
2. The table is heavy. Assembly requires two adults. Follow all assembly instructions carefully.
3. Make sure to position the table in an area where there is sufficient space to play so players will not be harmed by surrounding objects while playing.

Maintenance

1. The table is designed for indoor use only and should be kept in a ventilated space away from: direct sunlight, extensive humidity, high temperatures, corrosive environments, and rain.
2. Proper care and maintenance of your table's surface is required for long term performance. Over time, your table's playing surface can build up layers of dirt and grime. You can protect your investment with the Killerspin table tennis surface cleaner - MyT Clean.
3. MyT Clean helps maintain superior conditions for optimal play. It removes the dust, dirt, grease and fingerprints that can build up and make your table look worn. Keep your table tennis surface clean for the best bounce, and maximum shot control.
4. Children's use should be properly supervised.

Tools



Revolution SVR Classic Series

TABLE MODEL

Part List

1. Lay the boxes on a smooth, clean surface.
2. Open the lid and check to make sure you have all the parts:

a. BOX #1

Table Top x2



Table Top Frame x2

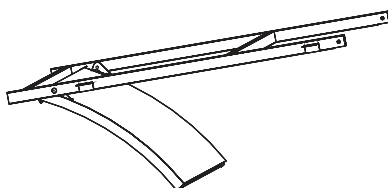

Net-post Set x1



Retaining
Screw x4



Foot
Screw x4



Base Cap x2

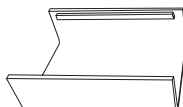

Nut x4



Hex Bolt x8



Bolt x4



Washer x16



Reinforced Support x2



Plastic Spacer x4



b. BOX #2

Undercarriage x2

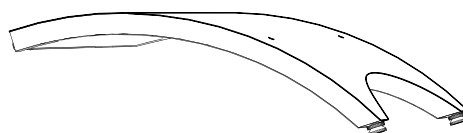

Revolution SVR Classic Series

TABLE MODEL

Assembly

Please read carefully.
Assembly requires two adults.



1. Using 2 people, remove (2) Undercarriages from the box. Place them on their side onto a blanket or piece of cardboard, free of any debris, so you do not scratch the surfaces.

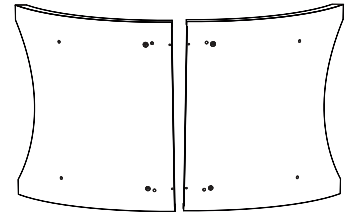

2. Slide the two Undercarriage halves together. Attach (2) Reinforced Support to the Undercarriage using (2) Plastic Spacers, (4) Washers, and (4) Hex Bolts. Carefully flip the assembly upright and remove the blanket or cardboard.

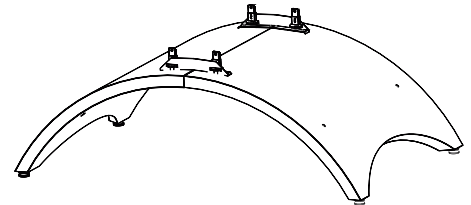
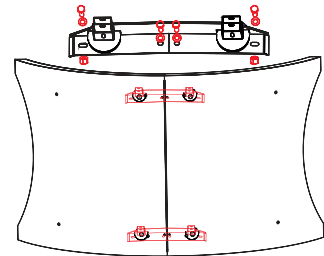

3. Using 2 people, remove (2) Table Tops from the box and place them upside down onto a blanket or piece of cardboard, free of any debris, so you do not scratch the playing surfaces.

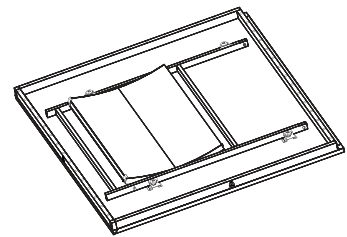

4. Loosen the (4) Screw Nuts, then remove and set aside the Table Top Frame. Repeat this step on the other half of the assembly.

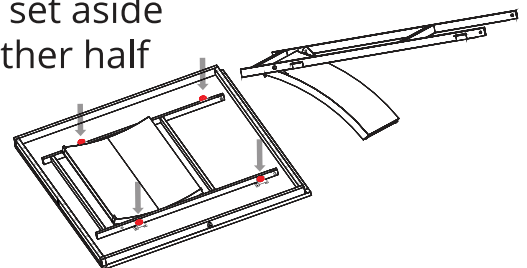

Revolution SVR Classic Series

TABLE MODEL

5. Using (1) Table Top Frame, insert the two tabs on the bottom of the Supporting Board into the holes in the Undercarriage. Then slide the tops of the Reinforced Supports into the slots in the ends of the Table Top Frame. Repeat this step on the other half of the assembly. Attach the Undercarriage to the Support Board using (2) Retaining Screws. Repeat this step on the other half of the assembly.

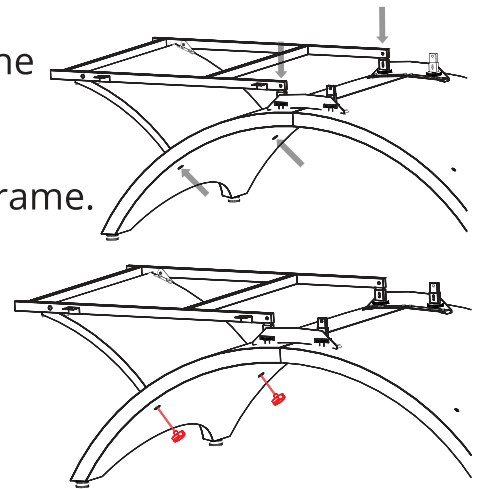

6. Attach the Table Top Frame to the Reinforced Supports using (1) Bolt, (2) Washers, and (1) Nut. Repeat this step on the other three attachment points.

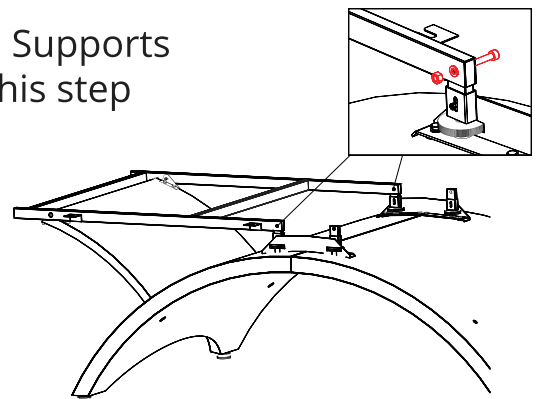

7. Carefully place the Table Top onto the Table Top Frame, then slide it forward so the (4) Screw Nuts slide into the slots in the Table Top Frame. Tighten all four Screw Nuts to secure the Table Top. Repeat this step on the other half of the assembly.

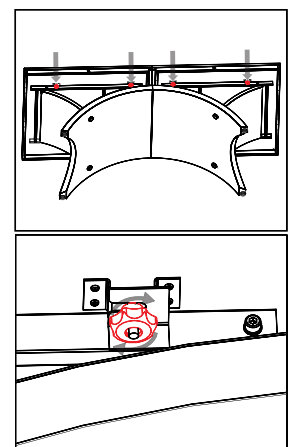
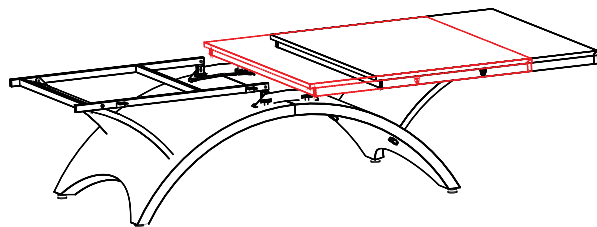

Revolution SVR Classic Series

TABLE MODEL

Adjustments

TABLE TOP HEIGHT ADJUSTMENTS

The following step will show you how to adjust the height of each Table Top so they are level.

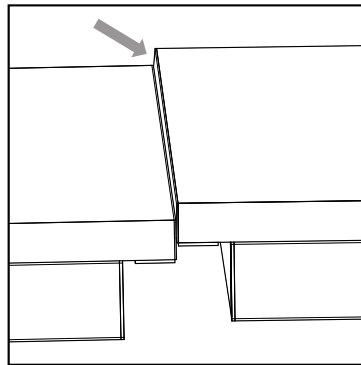

1. Lift the Table Top while turning the height adjustment knob clockwise to raise the Table Top until it is even with the other side. Raise the other side of the same Table Top you adjusted in the previous step until it is even with the other Table Top.

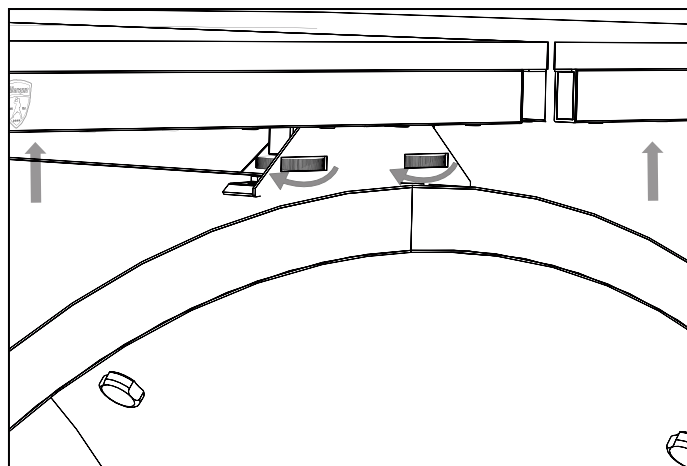

Revolution SVR Classic Series

TABLE MODEL

2. Adjust the (4) Foot Screws until the table is level.

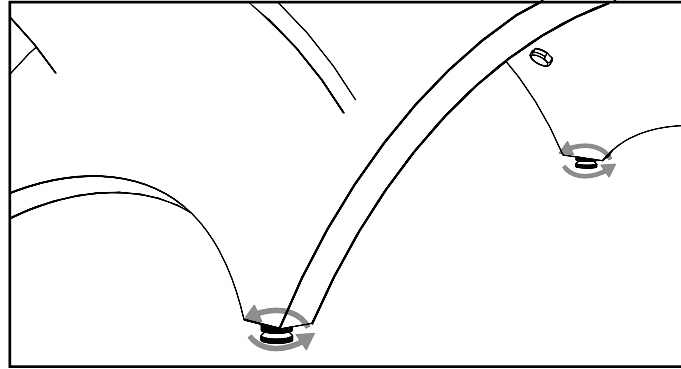

The recommended height for the Table is 2 feet 6 inches from the ground. Screw the Foot Nuts up to lock the feet into place.

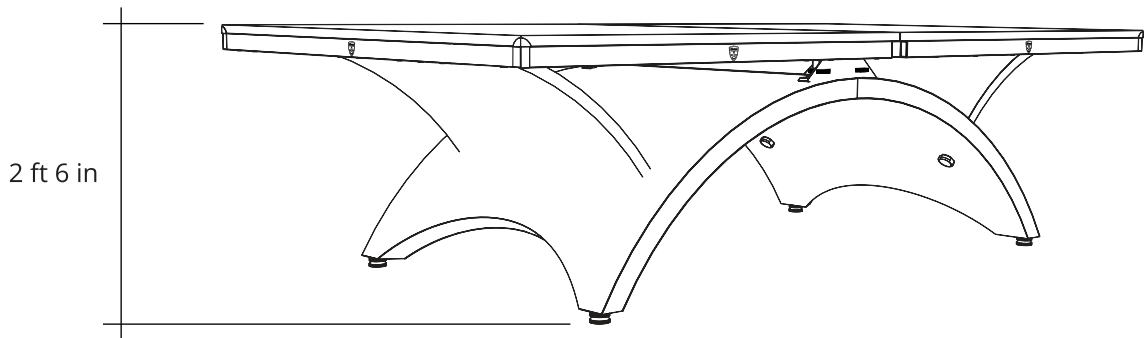

3. Attach (1) Base Cap to the Undercarriage where the two halves meet. Repeat this step on the other side of the assembly.

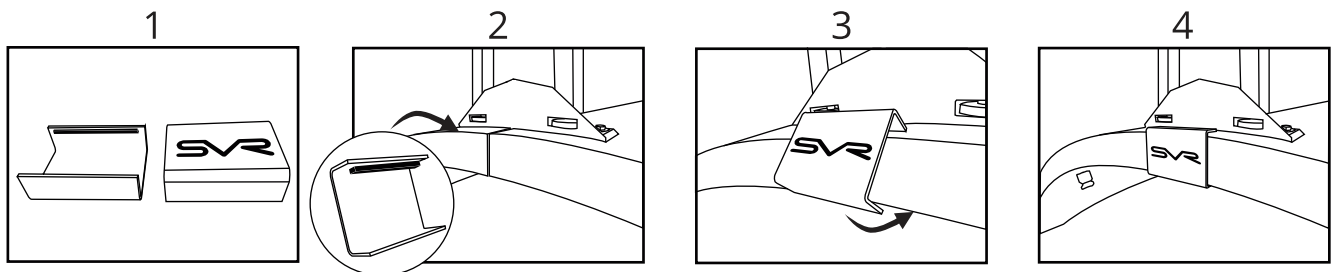

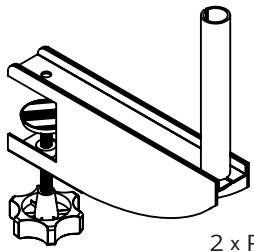

2 x Posts

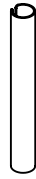

2 x Inner Tubes



2 x Metal Rods



4 x Tube Caps



1 Net



2 x Metal Bead Chains



1 Net height gauge

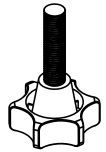

2 x Height Adjustment Knob

HOW TO INSTALL

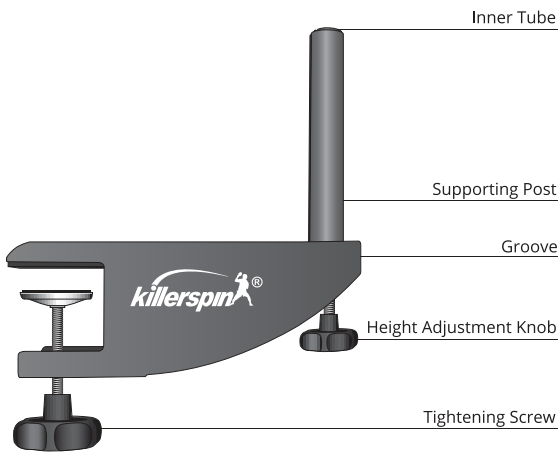

1 Remove the inner tube from the supporting post. Detach the plastic cap from one end of the inner tube and remove the metal rod.

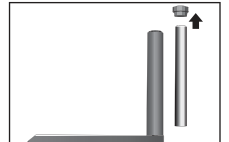

2 Thread the metal rod through the sleeve on the end of the net and slide into gap on the inner tub. Replace the plastic cap. Insert the inner tube into the supporting post - repeat process for the other side.

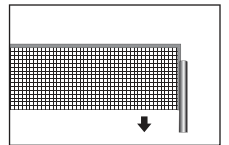

3 Fasten posts to each side of the table, one at a time. Once one side is screwed tight, gradually fasten the other post and tighten by angling the post onto the table.

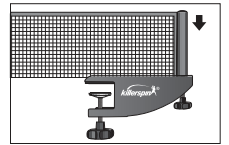

4 Attach metal beads to each side of the net cord and insert beads into groove on post to gain tension on the top edge of the net.

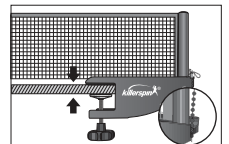

5 If necessary, use the height adjustment knob to raise or lower the net height to the desired level (a net-height gauge is included.)

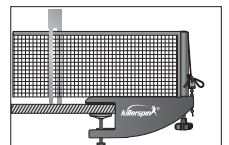

CONGRATULATIONS!

This completes the assembly of the Killerspin Revolution SVR

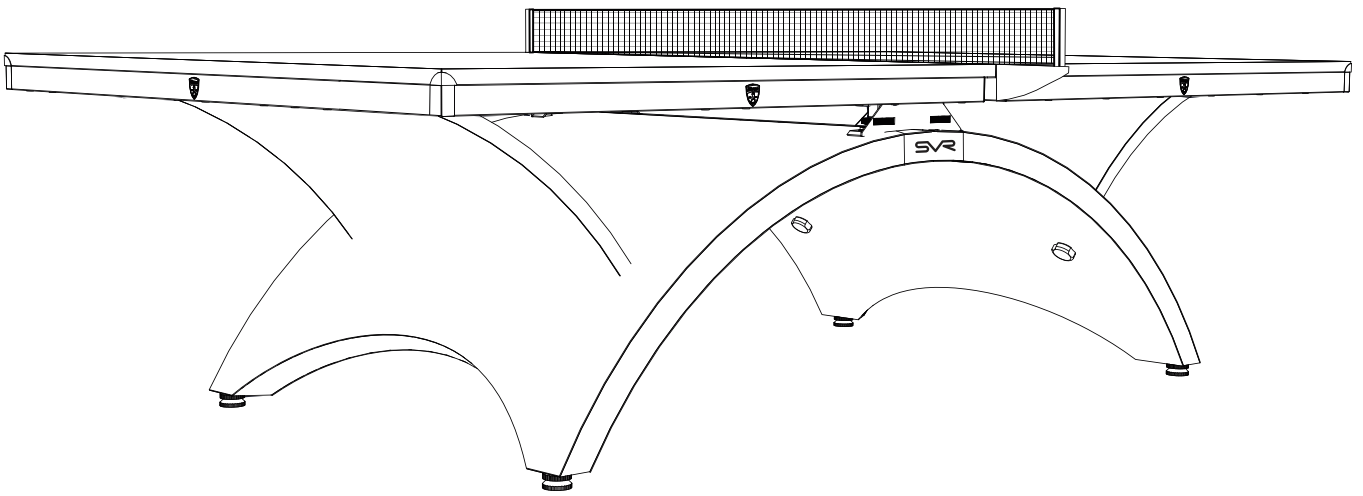

Revolution SVR Classic Series

TABLE MODEL

Dimensions

Length: 9 ft (274 cm)

Width: 5 ft (152.5 cm)

Height: 2 ft 6 in (76 cm)

Table Top: 1"

Package

No.1 Size: 65 x 59 x 10 in

Weight: 286 lbs

Include: Table Top x2, Table Top Frame x2, Retaining Screw x4, Foot Screw x4, Net-post Set x1, Base Cap x2, Nut x4, Hex Bolt x8, Bolt x4 Washer x16, Reinforced Support x2, Plastic Spacer x4

No.2 Size: 56 ½ x 52 ½ x 15 ¼ in

Weight: 146 lbs

Include: Undercarriage x2



Designed by Killerspin in Chicago

Killerspin LLC
33 W. Monroe Street
Suite 1050
Chicago, IL 60603

www.killerspin.com

killerspin  concierge:
1-866-577-5291