

BAUMANN

convection oven

Fast, power-efficient and perfectly even cooking

BM-GR18BC



INSTRUCTIONS MANUAL

www.baumannliving.com

Table of Contents

IMPORTANT SAFEGUARDS 1

GETTING TO KNOW YOUR OVEN..... 3

BEFORE USING YOUR OVEN 4

HOW TO BROIL 5

HOW TO BAKE 6

HOW TO TOAST 7

CONVECTION FUNCTION 7

CLEANING AND MAINTENANCE 8

IMPORTANT SAFEGUARDS

When using any electrical appliance, basic safety precautions should always be followed including the following:

1. **Read all instructions.**
2. **Do not** touch hot surfaces. Always use handles or knobs.
3. To protect against electric shock, do not immerse cord, plug or any parts of the oven in water or any other liquids.
4. **Do not** let cord hang over edge of table or counter, or touch hot surfaces.
5. **Do not** operate appliance with damaged cord or plug or after the appliance malfunctions or has been damage in any manner. Return appliance to the nearest authorized service facility for examination, repair or adjustment.
6. The use of accessory attachments not recommended by the appliance manufacturer may cause hazard or injury.
7. **Do not** place on or near a hot gas or electric burner.
8. Unplug from outlet when not in use and before cleaning. Allow to cool before putting on or taking off parts, and before cleaning.
9. To disconnect, turn the time control to OFF, then remove the plug. Always hold the plug, and never pull the cord.
10. Extreme caution must be used when moving a drip pan containing hot oil or other hot liquids.
11. **Do not** cover crumb tray or any part of the oven with metal foil. This may cause the oven to overheat.
12. Use extreme caution when removing the tray, racks or disposing of hot grease or other hot liquids.
13. **Do not** clean the inside of the oven with metal scouring pads, pieces can break off the pad and touch electrical parts, creating

a risk of electric shock.

14. Oversized foods or metal utensils must not be inserted in a toaster oven as they may create a fire or risk of electric risk.
15. A fire may occur if the oven is covered or touching flammable material, including the curtains, draperies, walls, and the like, when in operation. Do not store any item on top of the appliance when in operation.
16. Extreme cautions should be exercised when using cooking or baking containers constructed of anything other than metal or ovenproof glass.
17. Be sure that nothing touches the top or bottom elements of the oven.
18. **Do not** place any of the following materials in the oven: cardboard, plastic, paper, or anything similar.
19. **Do not** store any materials other than manufacturer's recommended accessories in this oven when not in use.
20. Always wear protective, insulated oven gloves or use a special handle when inserting or removing items from a hot oven.
21. This appliance has a tempered, safety glass door. The glass is stronger than ordinary glass and more resistant to breakage. Tempered glass can still break around edges. Avoid scratching door surface or nicking edges.
22. **Do not** use outdoors.
23. **Do not** use appliance for other than intended use.
24. The appliance can be used by children aged from 8 years and above and persons with reduced physical sensory or mental capabilities or lack of experience and knowledge if they have been given supervision or instruction concerning use of the appliance in a safe way and understand the hazards involved.

25. Cleaning and user maintenance shall not be made by children unless they are older than 8 and supervised.
26. Keep the appliance and its cord out of reach of children less than 8 years.
27. If the supply cord is damaged, it must be replaced by the manufacturer, its service agent or similarly qualified persons in order to avoid a hazard.
28. The door or the outer surface may get hot when the appliance is operating.

SAVE THESE INSTRUCTIONS. FOR HOUSEHOLD USE ONLY.

GETTING TO KNOW YOUR OVEN

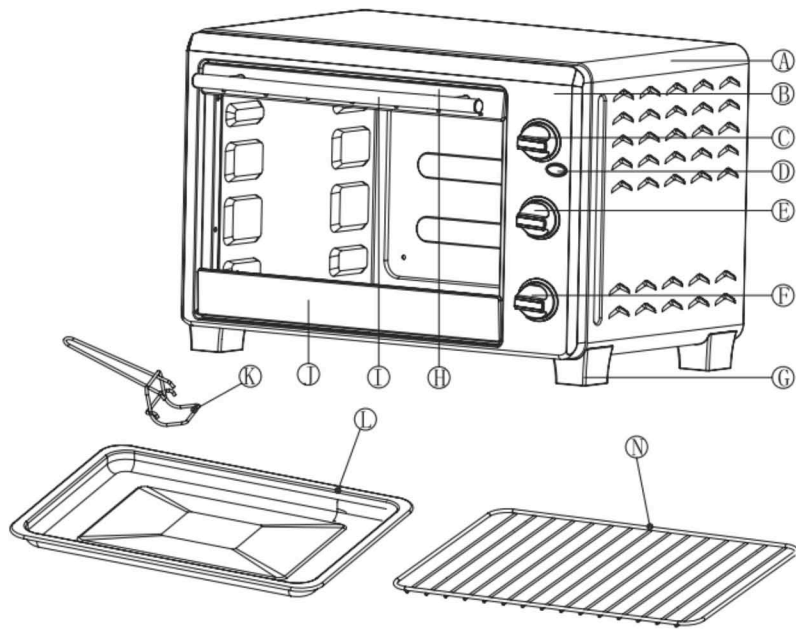

- | | |
|-----------------------------|---------------------|
| F. Housing | A. Upper Door Frame |
| G. Front Panel | B. Handle |
| H. Temperature Control Knob | C. Lower Door Frame |
| I. Indicator Light | D. Tray Handle |
| J. Function Control Knob | E. Bake Tray |
| K. Timer | N. Wire Rack |
| L. Oven Foot | |

BEFORE USING YOUR OVEN

Before using your electric oven for the first time, be sure to:

1. Read all of the instruction included in this manual.
2. Make sure that the oven is unplugged and the **Time control** is in the "OFF" position.
3. Wash all the accessories in hot, soapy water or in the dishwasher.
4. Thoroughly dry all accessories and re-assemble in oven, plug oven into outlet and you are ready to use your new toaster oven.
5. After re-assembling your oven, we recommend that you run it at the highest temperature (250°C) on the toast function for approximately 15 minutes to eliminate any packing residue that may remain after shipping. This will also remove all traces of odor initially present.

PLEASE NOTE: When this appliance is used for the first time, the unit will emit a smell of burning and some smoke. This is normal and is caused by the insulation on the elements and some dust particles on the elements.

Please familiarize yourself with the following oven functions and accessories prior to first use:

Temperature Control: choose the desired temperature from 100°C to 250°C for cooking.

Main Function Control:

Broil (): the upper two heating elements work.

Bake (): the lower two heating elements work.

Toast (): both upper and lower heating elements work together.

Timer: turn to the right (clockwise) to toast or use as a timer. This function also has a bell ring at the end of the programmed time.

Indicator light: It will light when the heating element is turned on.

Bake Tray: For use in broiling and roasting meat, poultry, fish and other food. Can also be used as a drip pan to catch oil drippings.

Tray Handle: Allows you to pick up the wire rack and bake tray when they are hot.

Wire Rack: For toasting, baking, and general cooking in casserole dishes and standard pans.

CAUTION: TO AVOID RISK OF INJURY OR BURNS, DO NOT TOUCH HOT SURFACES WHEN OVEN IS IN USE. ALWAYS TAKE EXTREME CARE WHEN REMOVING THE BAKE TRAY, WIRE RACK OR ANY HOT CONTAINER FROM A HOT OVEN. ALWAYS USE THE TRAY HANDLE OR AN OVEN MITT.

HOW TO BROIL

For best results, it is recommended that you preheat the oven for 15 minutes on 250°C.

- Place food on the wire rack and slide into the top rack position. Food should be placed as close as possible to the top heating element without touching it.
- Put back tray at the lowest rack position to catch possible drippings.

- To prevent fire hazards, it is suggested to wrap food with aluminum foil.
- Set the temperature control knob to appropriate temperature.
- Brush food with sauces or oil, as desired.
- Set function knob to "Upper heater"()
- Turn time knob to your desired cooking time.
- Turn food over midway through the prescribed cooking time.
- To check or remove roast, use the tray handle provided to help you slide the roast in and out.
- When broiling is complete, turn the function control to "OFF" position

HOW TO BAKE

Please note that the BAKE function uses only the bottom heating elements. For best results, it is recommended that you preheat the oven for 15 minutes on 250°C.

- Set temperature control to appropriate temperature.
- Place the wire rack on the lowest or middle rack support guide.
- Place food on the wire rack and slide into the rack.
- Food should be placed as close as possible to the lower heating element without touching it.
- Brush food with sauces or oil, as desired.
- Turn time control to your desired cooking time.
- Turn the function control to "Lower Heater"()
- Turn food over midway through the prescribed cooking time.
- When baking is complete, turn the function knob to "OFF" position.

HOW TO TOAST

Please note that the TOAST function uses all the heating elements. Large capacity oven allows for toasting 4 to 6 slices of bread, 6 muffins, frozen waffles or frozen pancakes. When toasting only 1 or 2 items, place food on the bake rack in the center of the oven.

- Place food on the wire rack and slide into the middle rack position.
- Set the Temperature Control Knob to appropriate temperature.
- Set function knob to "Upper & Lower Heater"()
- Ensure Back tray is in place.
- Turn the time control knob to your desired cooking time.
- Bell will ring to signal the end of the toast cycle.
- When toasting is complete, turn function control to "OFF".

CONVECTION FUNCTION

Convection cooking combines hot air movement by means of a fan with the regular features (broil, bake and toast). Convection cooking provides faster cooking in many cases than regular radiant types of toaster oven. The fan gently sends air to every area of the food, quickly browning, crisping and sealing in moisture and flavor. It produces more even temperature all around the food by air movement, so that food cooks/bakes/broils evenly versus the normal ovens hot and cold spots. The convection feature allows cooking/baking at lower temperatures, which saves energy and helps keep the kitchen cooler. Convection air is superheated and it

circulates around the food so it cooks food significantly faster than conventional ovens.

The convection fan works when the function knob is set on any position. When the desired temperature and function are chosen, set the timer at the desired position. The convection fan will start operating.



CLEANING AND MAINTENANCE

1. Remove the plug from the wall socket and allow the appliance to cool down completely.
2. Use warm water with a small amount of mild dishwashing liquid to clean the baking tray, wire rack and tray handle. Rinse with plenty of water and dry thoroughly.
3. Use a damp cloth to clean the interior and exterior of the oven and the door. Dry thoroughly.
4. Place all the items back in the oven to store.



- Make sure the plug has been removed from the plug socket before cleaning the appliance.
- Never use corrosive or scouring cleaning agents or sharp objects (such as knives or hard brushes) to clean the appliance.
- Never immerse the appliance, the power cord or the plug, in water or any other liquid.

CLEAN THE APPLIANCE EVERY TIME AFTER USE.

 	<p>You can help protect the environment!</p> <p>Please remember to respect the local regulations: hand in the non-working electrical equipment to an appropriate waste disposal center.</p>
--	--