



RSG METAL WORKS
720.523.3999
ORDERS@RSGOFFROAD.COM

2016+ TOYOTA TACOMA (DOUBLE CAB SHORT BED & ACCESS CAB) ROCK SLIDER INSTALLATION INSTRUCTIONS

1. REMOVE ALL COMPONENTS FROM PACKAGING AND INSPECT FOR ACCURACY. PLEASE NOTIFY US IMMEDIATELY IF YOU HAVE MISSING OR INCORRECT PARTS.
2. REMOVE FACTORY AND AFTERMARKET STEPS.
3. START WITH THE PASSENGER SIDE SLIDER. REMOVE THE 4 BOLTS FROM THE FRAME, REMOVE THE PLASTIC COVER AND METAL PLATE SHOWN IN DIAGRAM "A & B". SAVE THE 2 BOLTS FROM THE PLASTIC COVER FOR REINSTALLATION LATER. DISCARD THE 2 BOLTS FROM THE METAL PLATE, UNDER THE PLASTIC COVER.

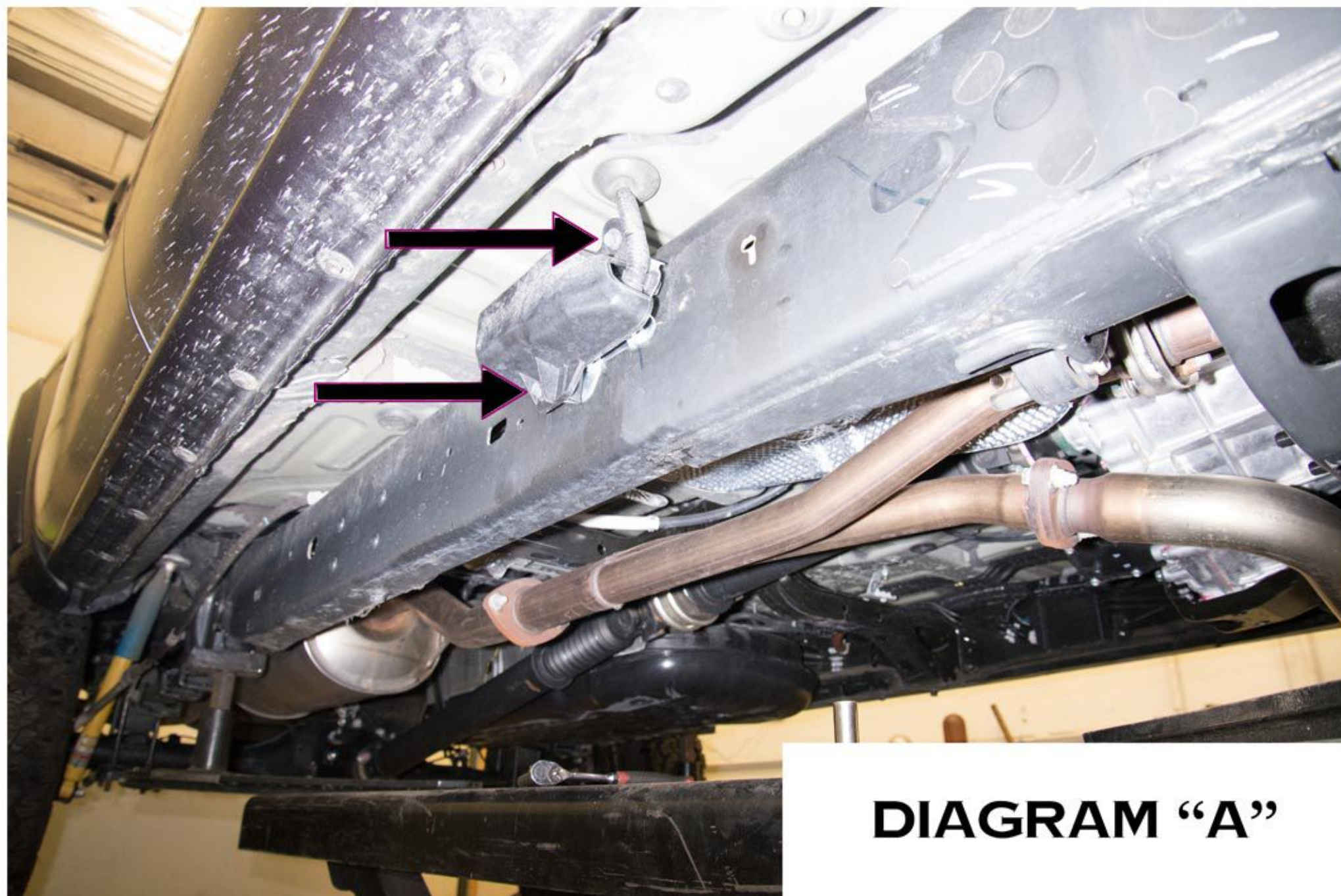

DIAGRAM "A"

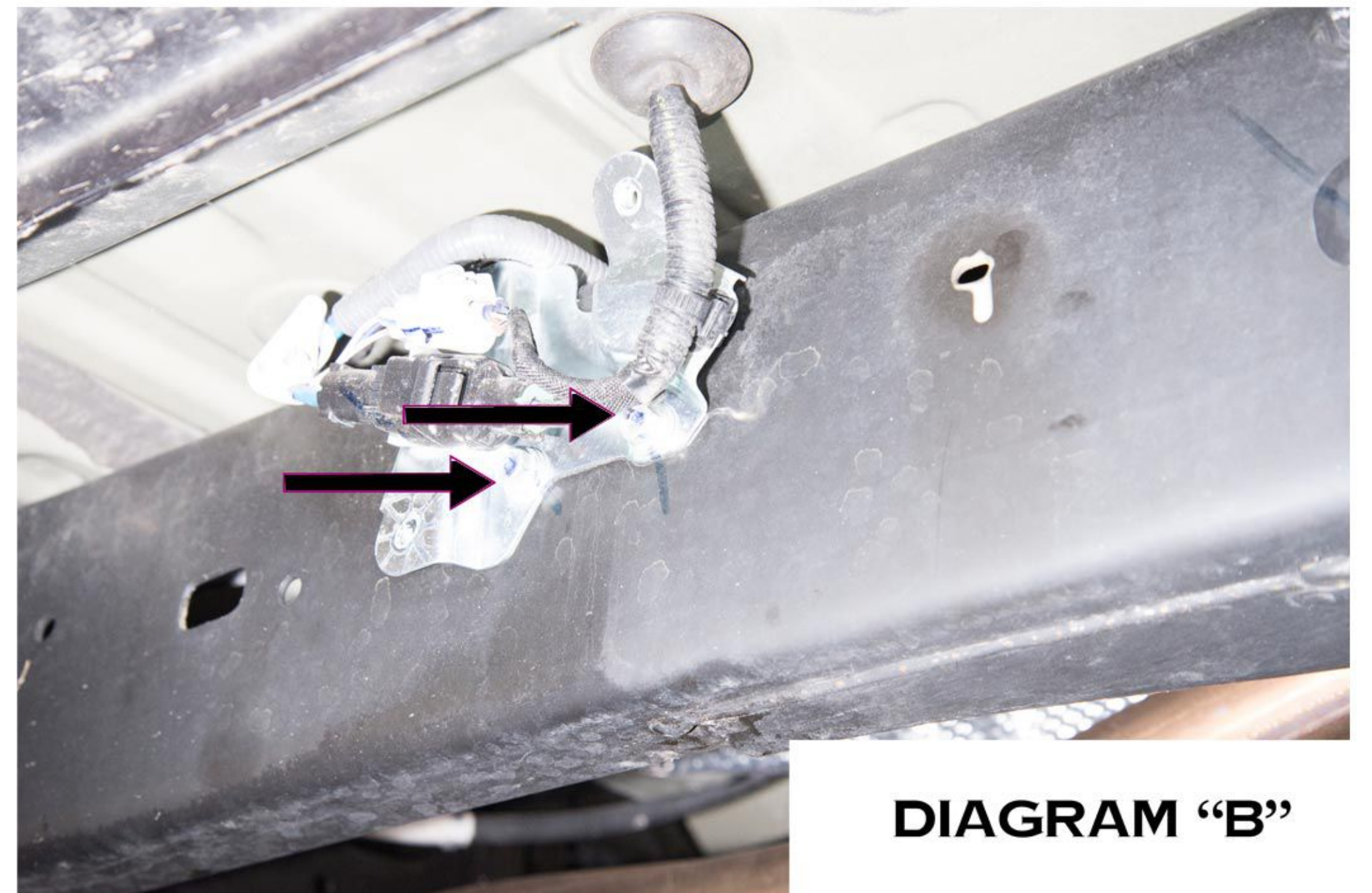

DIAGRAM "B"

4. YOU WILL NEED TO PRY OFF THE PLASTIC COVER AND STICKER SHOWN IN DIAGRAM "C & D"

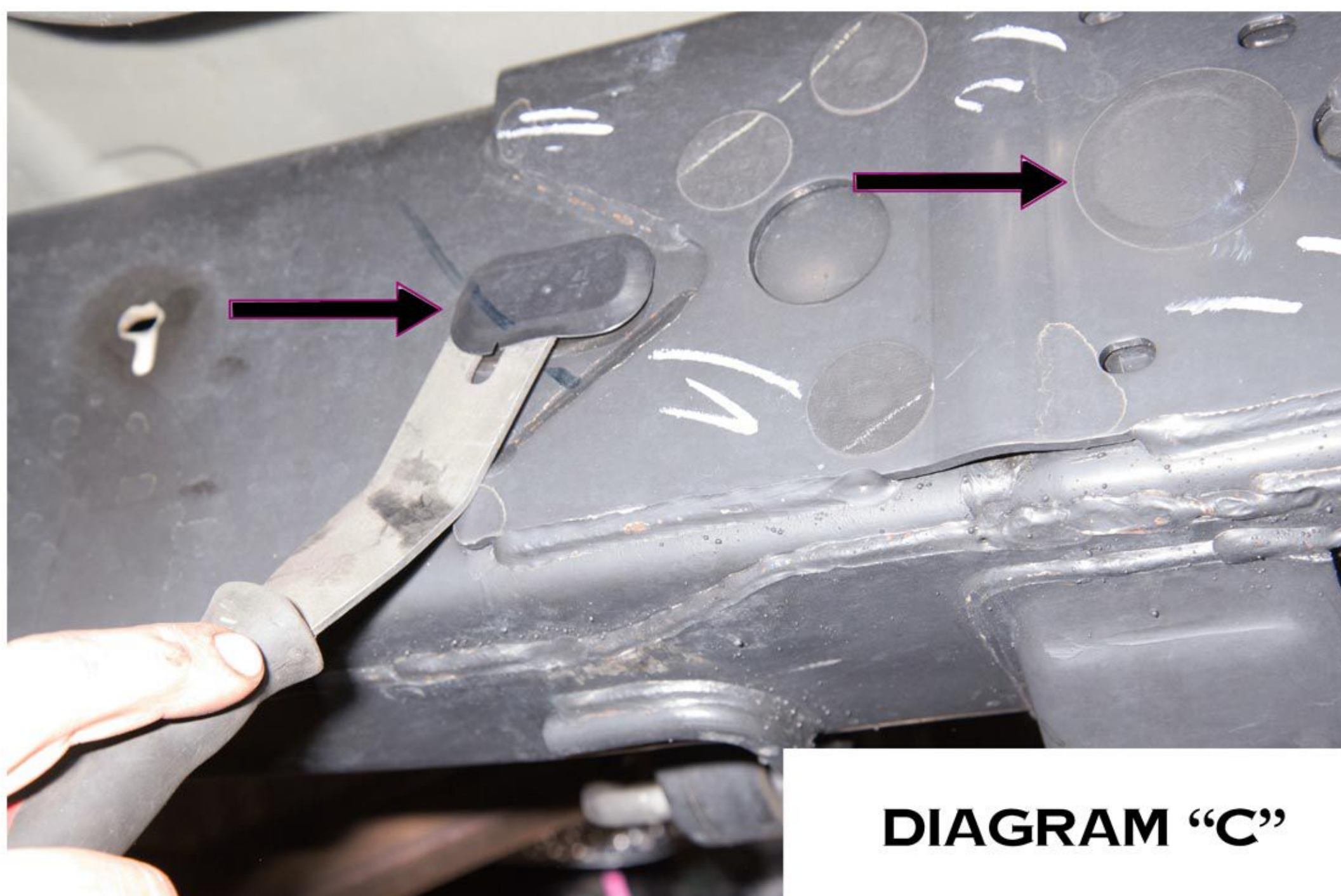

DIAGRAM "C"

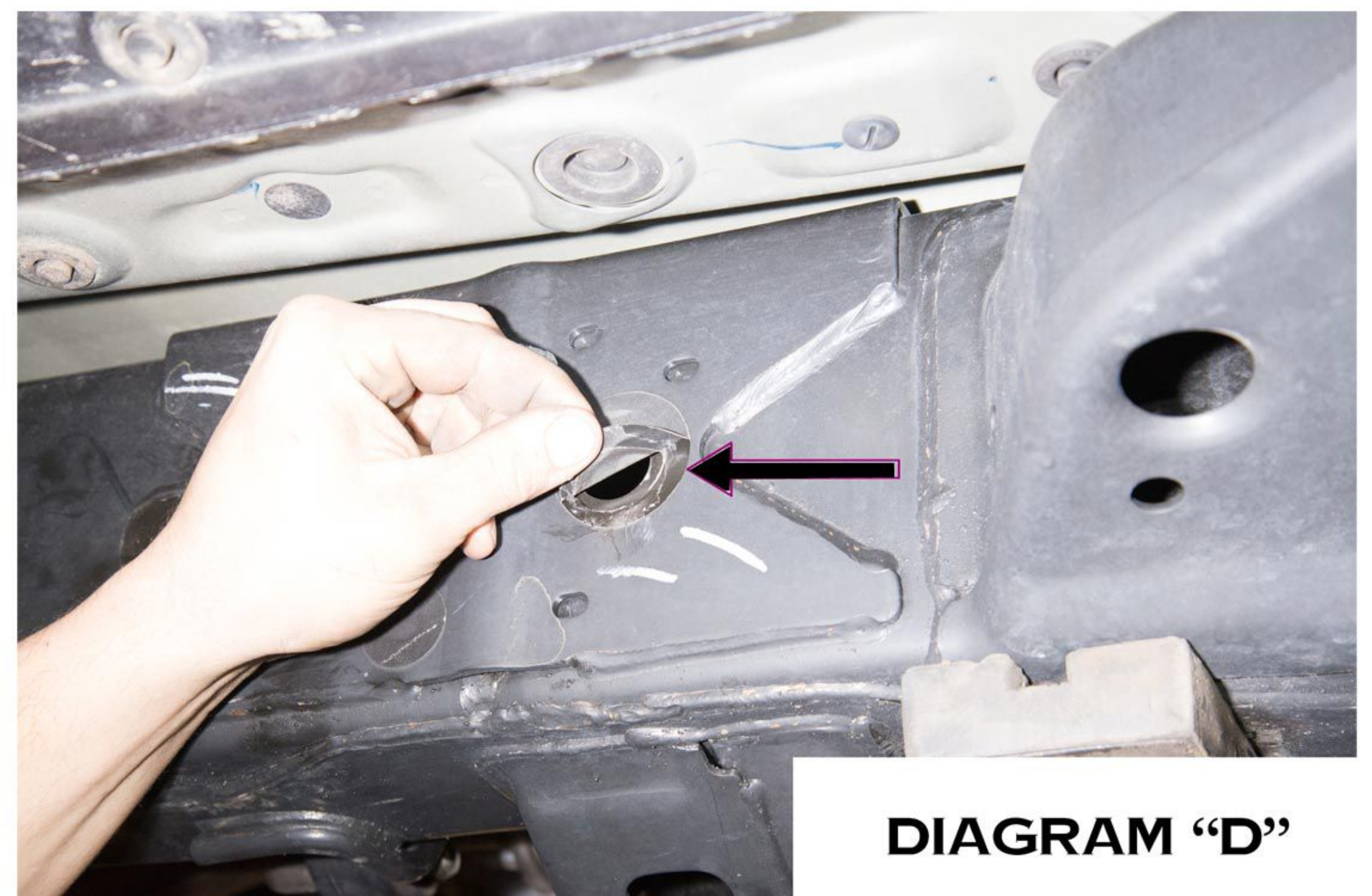

DIAGRAM "D"



RSG METAL WORKS
720.523.3999
ORDERS@RSGOFFROAD.COM

5. REMOVE THE PLATIC FRAME OPENING COVER ON THE INSIDE OF THE FRAME, ON THE PASSENGER SIDE, AS SHOWN ON DIAGRAM "E".

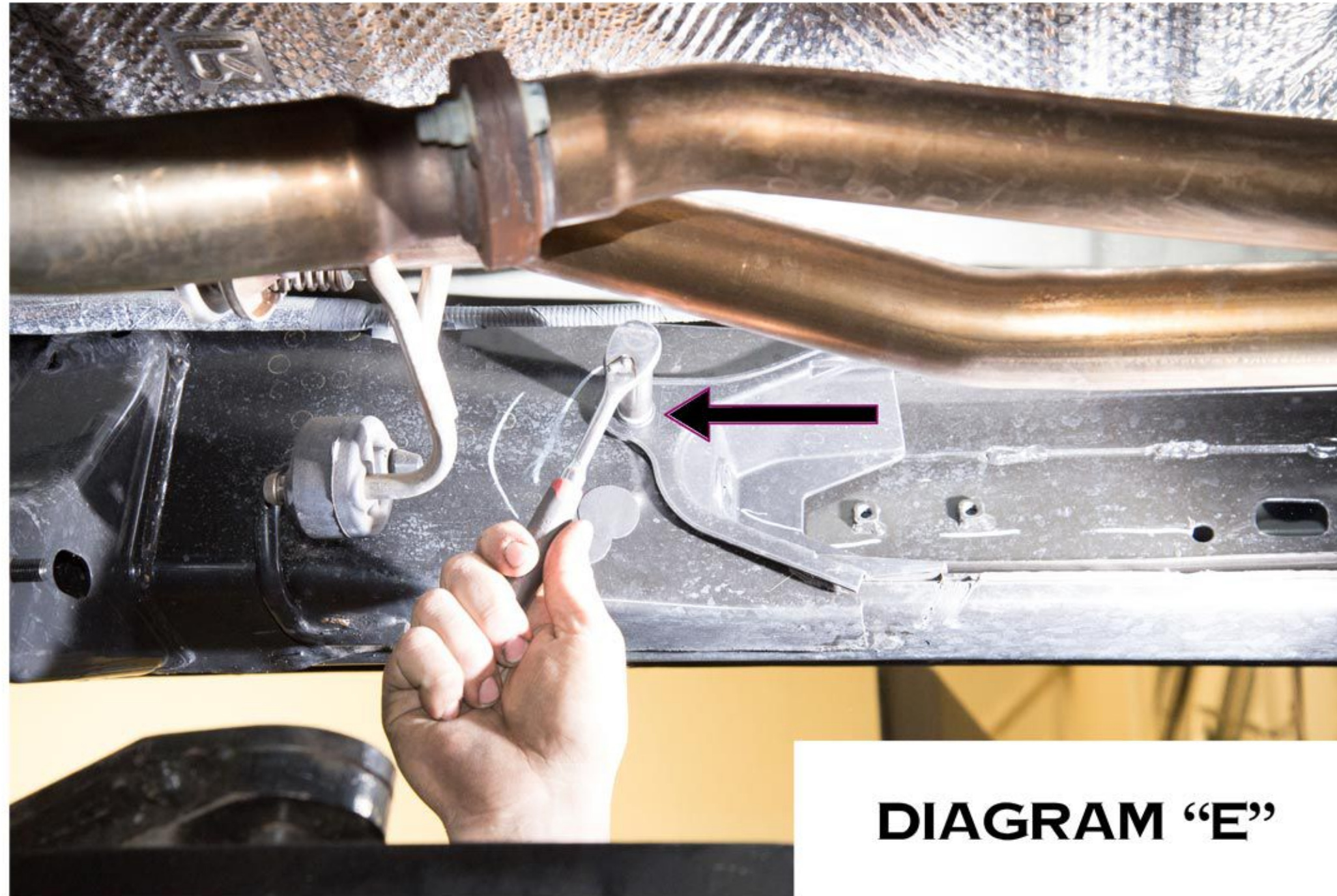

DIAGRAM "E"

6. POSITION THE PASSENGER SIDE SLIDER (YOU MAY WANT HELP HERE) AND START INSTALLING THE HARDWARE. (SEE THE HARDWARE DIAGRAM AT THE END OF THE INSTRUCTIONS FOR THE BOLT LOCATIONS). ENSURE THE PLATE THAT WAS REMOVED IN STEP 3 IS PLACED ON TOP OF THE SLIDER'S MOUNTING PLATE AND USE THE SUPPLIED HARDWARE TO BOLT IT IN PLACE AS SHOWN IN DIAGRAM "F".

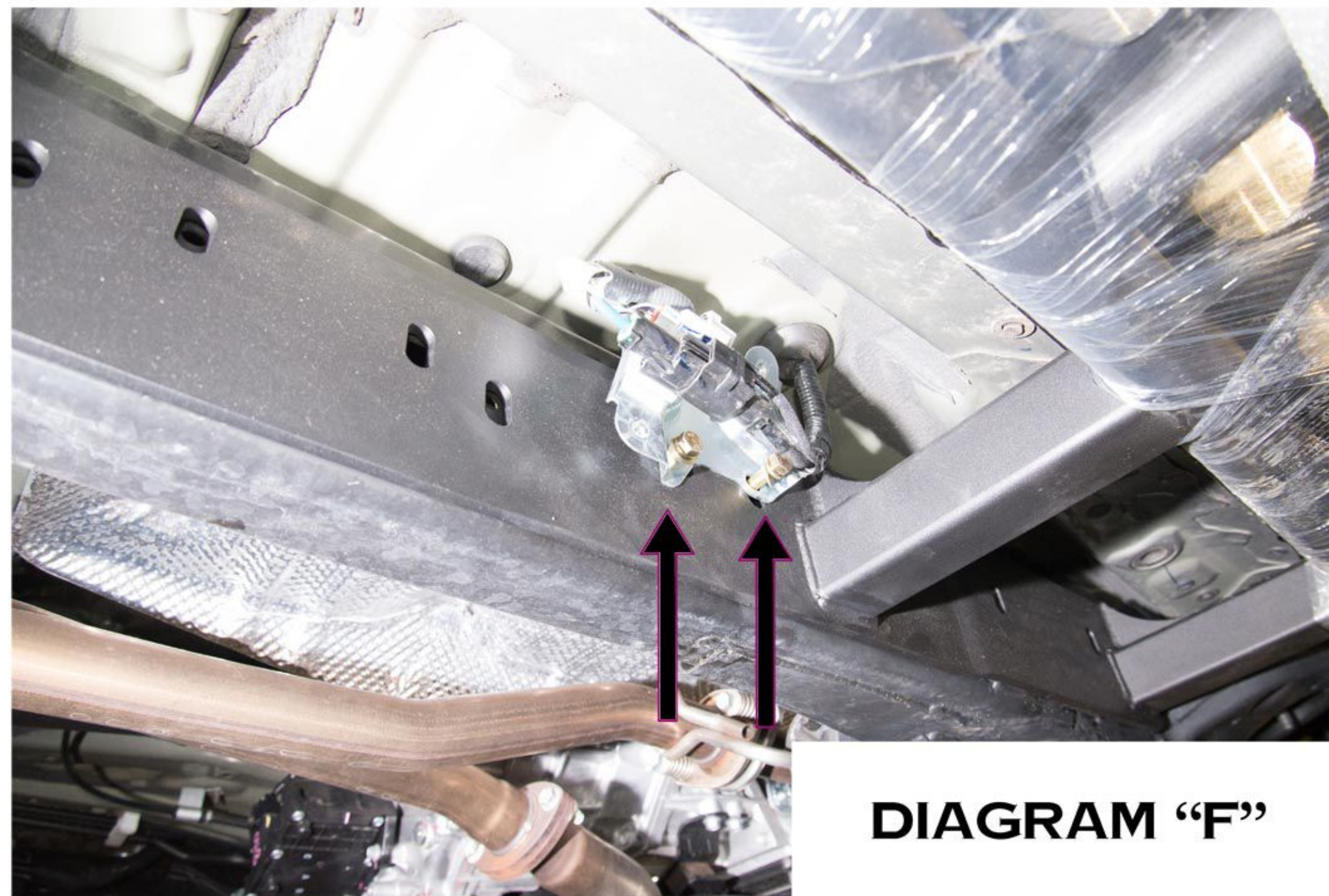

DIAGRAM "F"

7. LOOSELY INSTALL ALL 11 BOLTS FOR THE PASSENGER SLIDER, USE A MAGNET OR REACH INSIDE THE FRAME TO PLACE THE 2 NUT PLATES FOR MOUNTING THE FRONT OF THE SLIDER, SHOWN IN DIAGRAM "G & H".

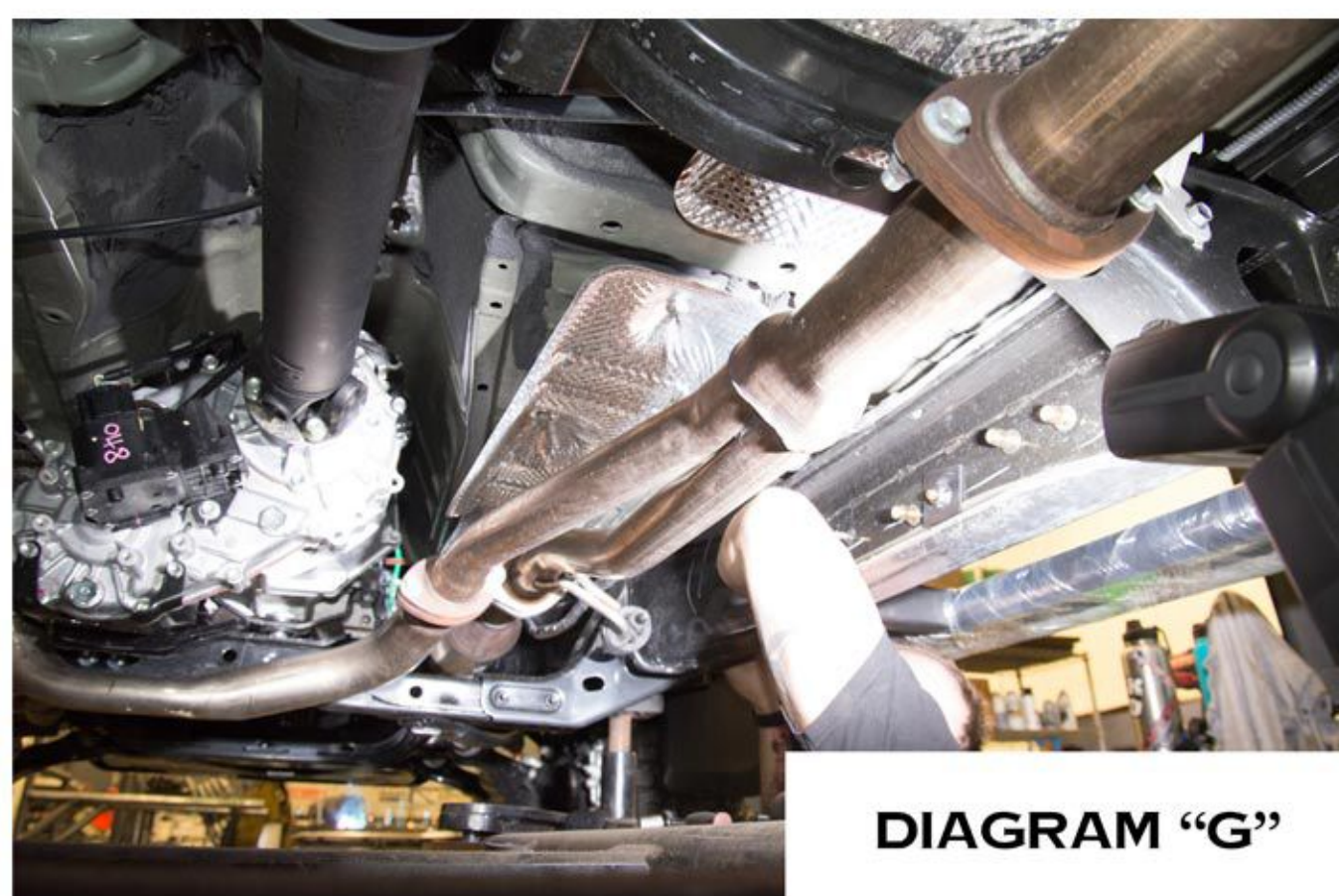

DIAGRAM "G"

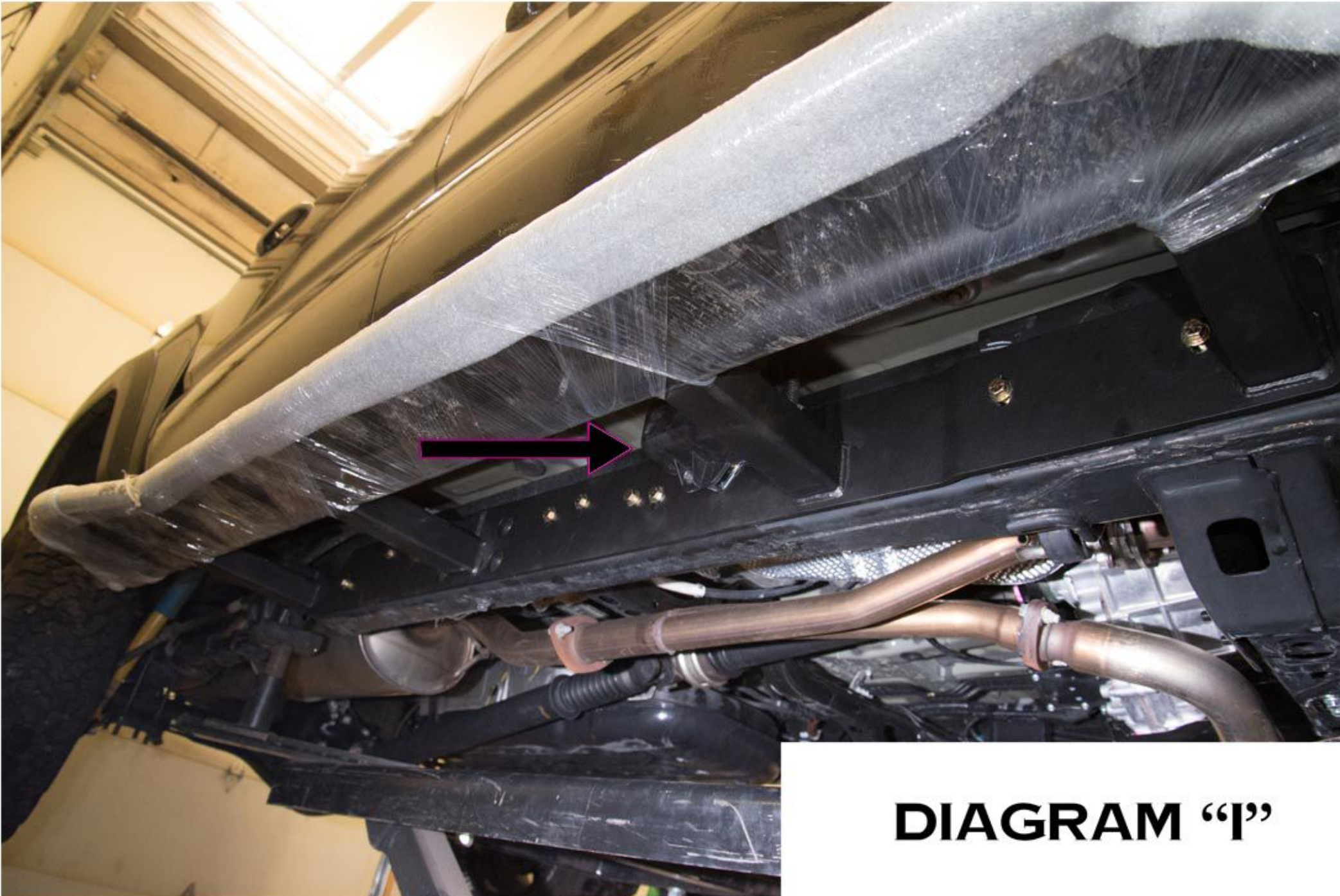

DIAGRAM "H"



RSG METAL WORKS
720.523.3999
ORDERS@RSGOFFROAD.COM

8. STARTING FROM ONE END OF THE SLIDER, ADJUST SLIDER TO LEVEL POSITION, WORK YOUR WAY TO THE OTHER END OF THE SLIDER TIGHTENING THE HARDWARE. USE THE BOLTS SAVED FROM STEP 3 TO REINSTALL PLASTIC COVER SHOWN IN DIAGRAM "I" AND PLASTIC FRAME OPENING COVER FROM STEP 5, AS SHOWN IN DIAGRAM "J".



9. NOW MOVE TO THE DRIVER'S SIDE. REMOVE BOLT FOR THE BRAKE LINES AND REMOVE THE WHITE CLIP HOLDING THE BRAKE LINES TO THE FRAME, SAVE THE BOLT FOR REINSTALLION LATER, AS SHOWN IN DIAGRAM "K". GENTLY BEND/PRY THE LINES AWAY FROM FRAME TO GAIN ACCESS TO THE PLASTIC FRAME OPENING COVER SHOWN IN DIAGRAM "L". REMOVE BOLT AND PLASTIC FRAME OPENING COVER.

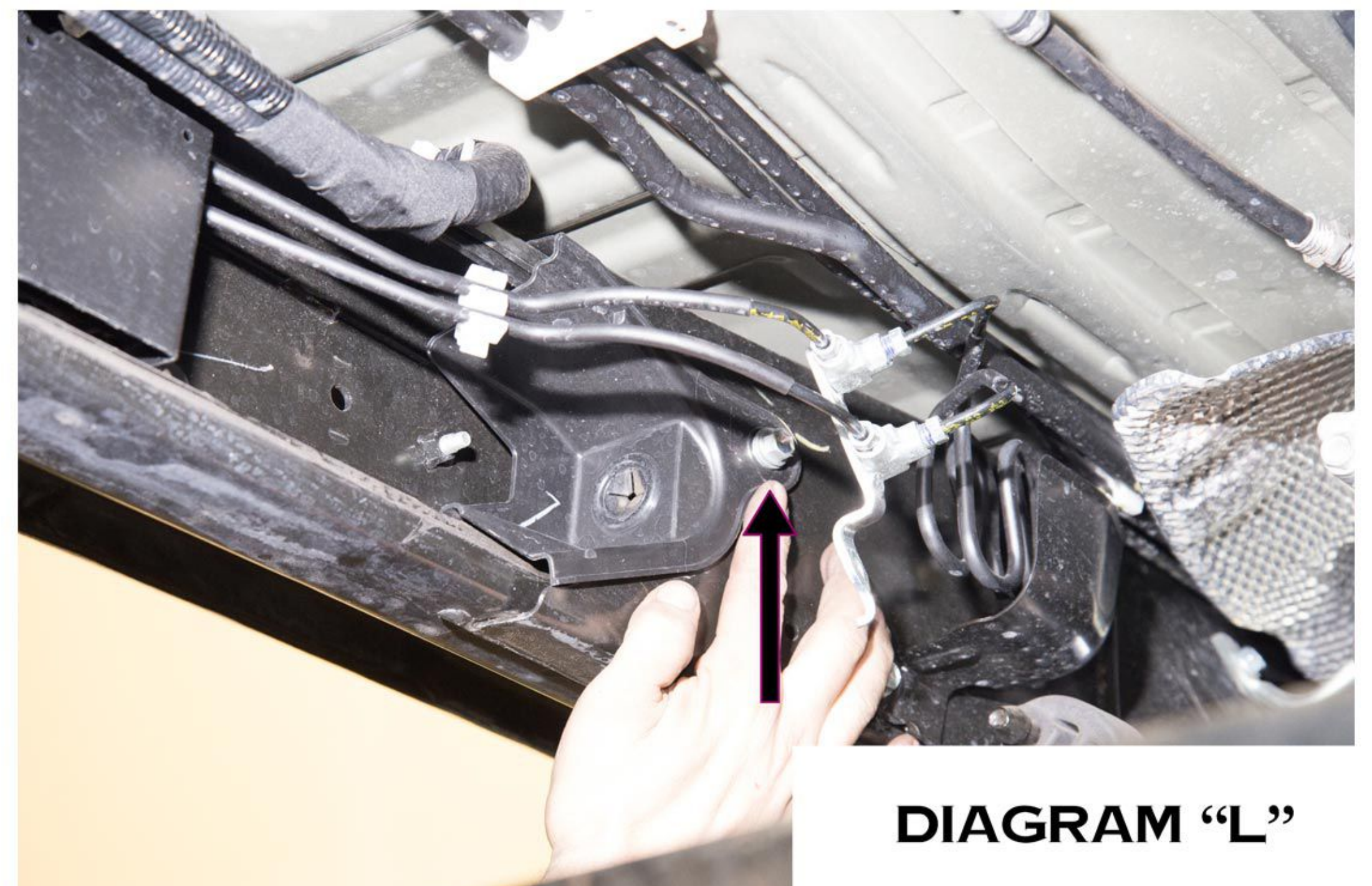
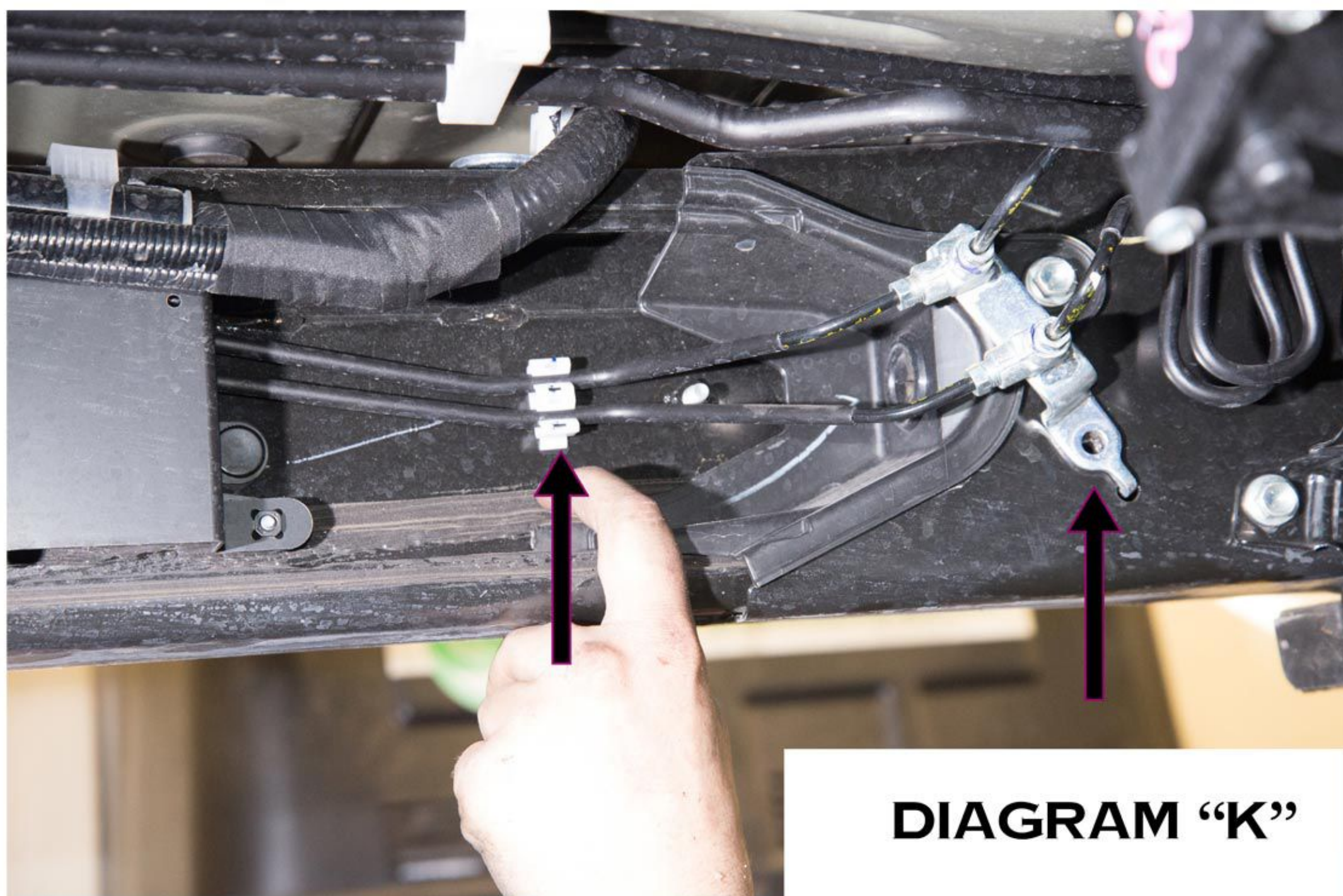

10. REMOVE THE 2 NUTS HOLDING THE MODULE TO THE FRAME AND 1 BOLT HOLDING WIRING HARNESS, SHOWN IN DIAGRAM "M". DISCARD BOLT, BUT SAVE NUTS FOR REINSTALLATION LATER.



RSG METAL WORKS
720.523.3999
ORDERS@RSGOFFROAD.COM

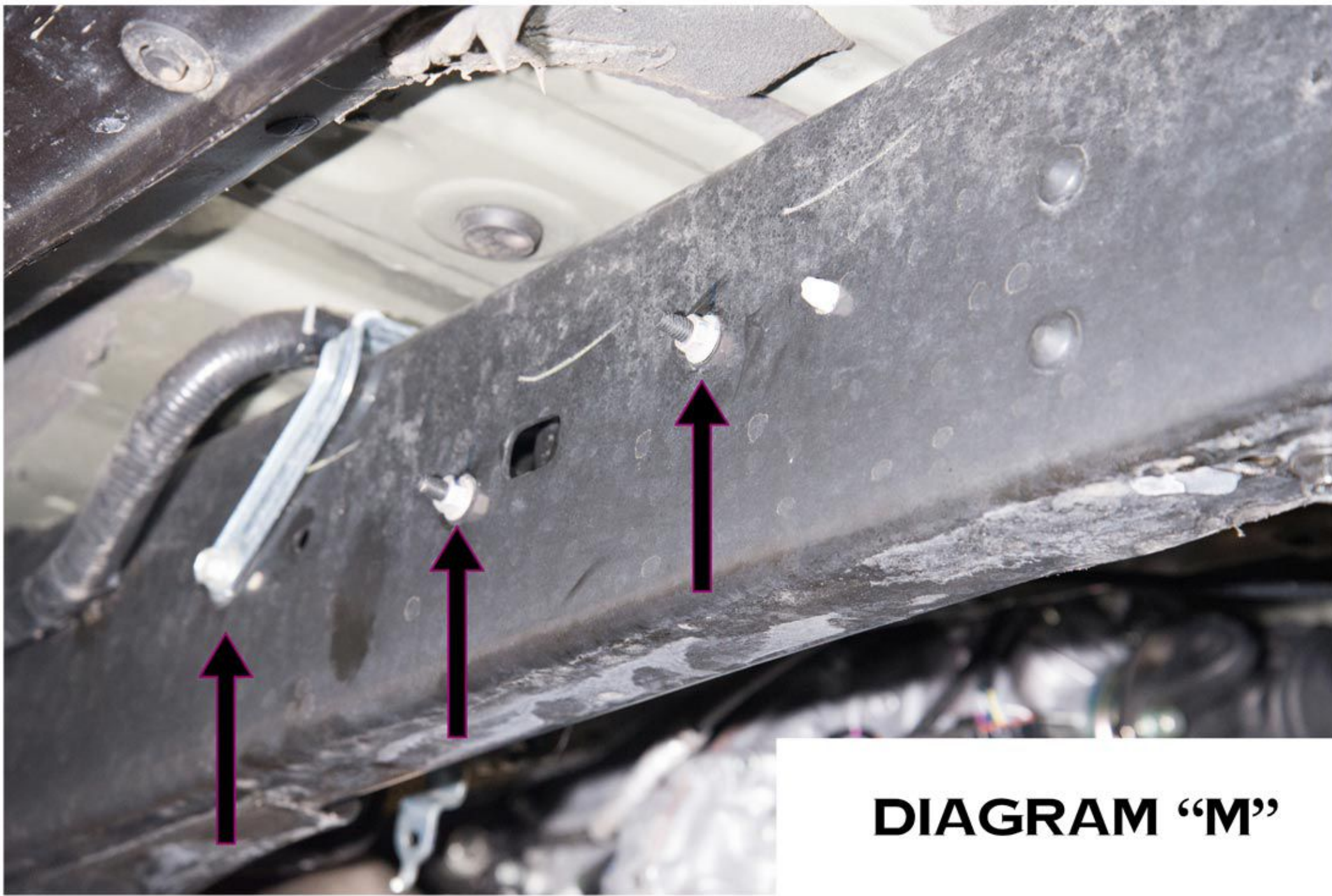

DIAGRAM "M"

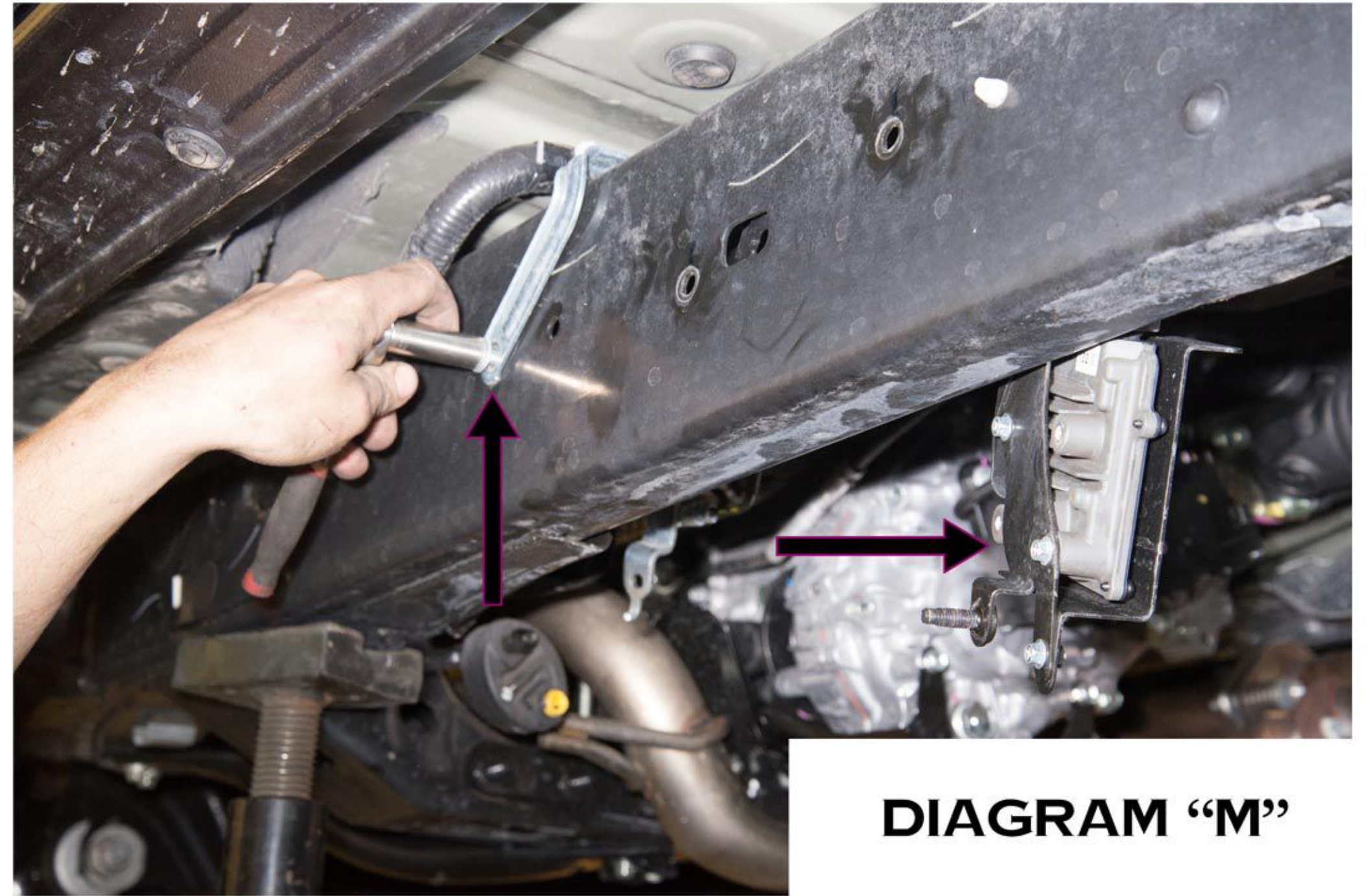

DIAGRAM "M"

11. USE A RAZOR BLADE AND CUT THE TAPE OFF OF THE PLASTIC CLIPS HOLDING THE WIRE HARNESS, AS SHOWN IN DIAGRAM "N". THEN REMOVE THE WHITE CLIPS, PLASTIC COVER, AND STICKER SHOWN IN DIAGRAM "O". (SAME PLASTIC COVERS AND STICKERS AS THE PASSENGER SIDE)

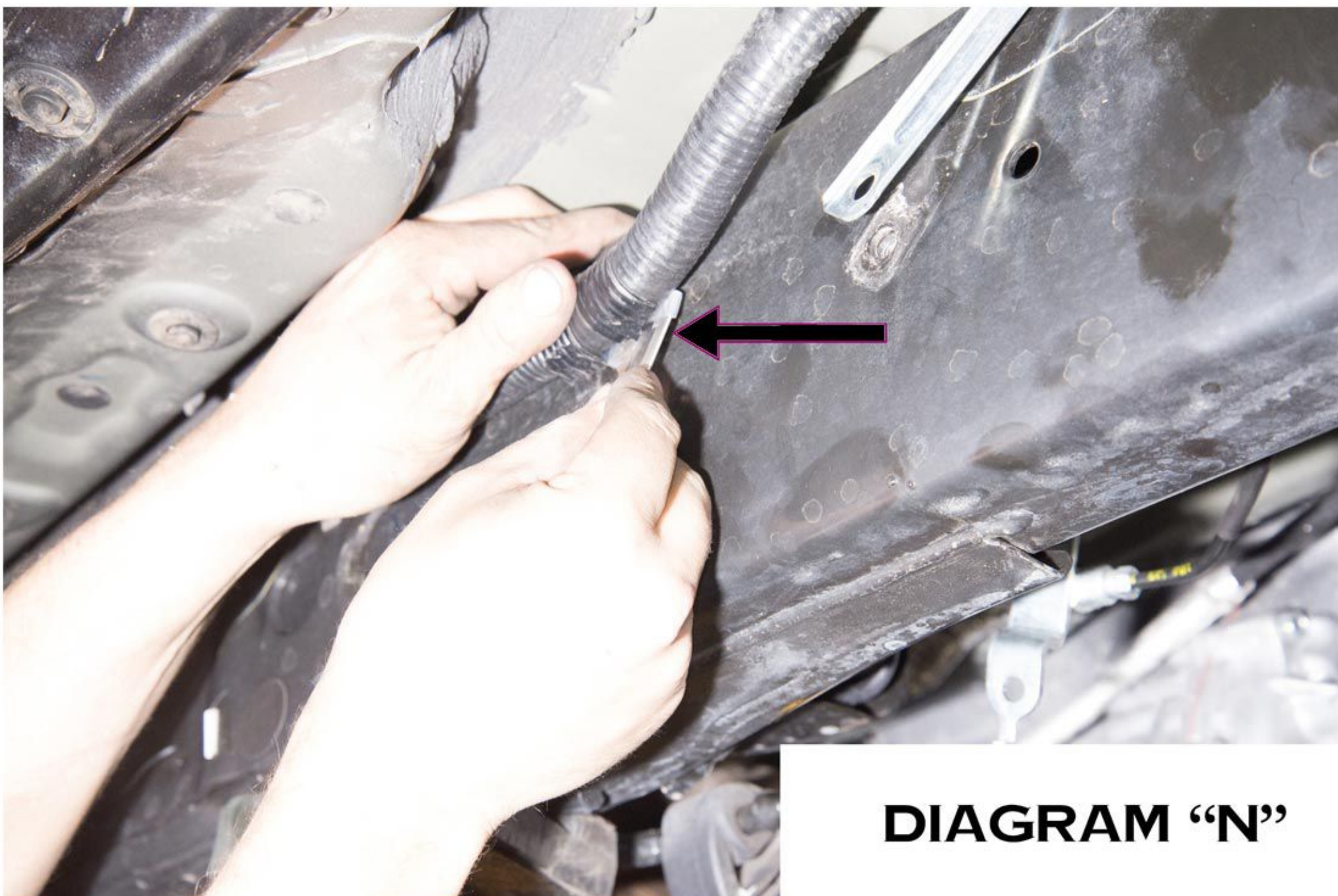

DIAGRAM "N"

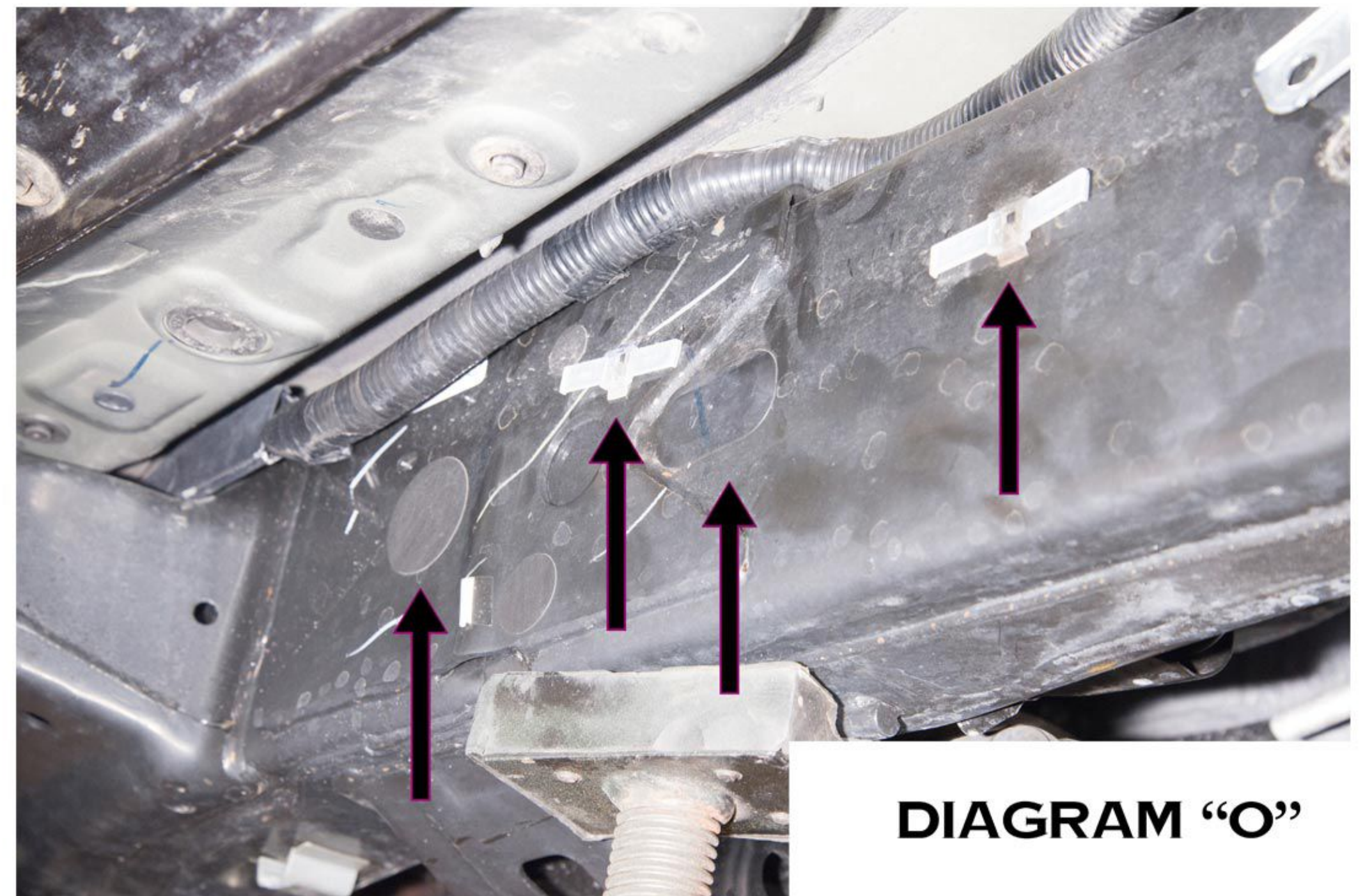

DIAGRAM "O"

12. MAKE SURE THE WIRE HARNESS IS OUT OF THE WAY AND POSITION THE DRIVER'S SLIDER (YOU MAY WANT HELP HERE). START INSTALLING THE HARDWARE. ENSURE THE WIRE HARNESS BRACKET REMOVED IN STEP 11 IS PLACED ON THE OUTSIDE OF THE SLIDER'S MOUNTING PLATE. ALSO BE CAREFUL NOT PINCH THE WIRING HARNESS BETWEEN THE FRAME AND MOUNTING PLATES. USE SUPPLIED HARDWARE TO REINSTALL THE WIRE HARNESS BRACKET, AS SHOWN ON DIAGRAM "P".

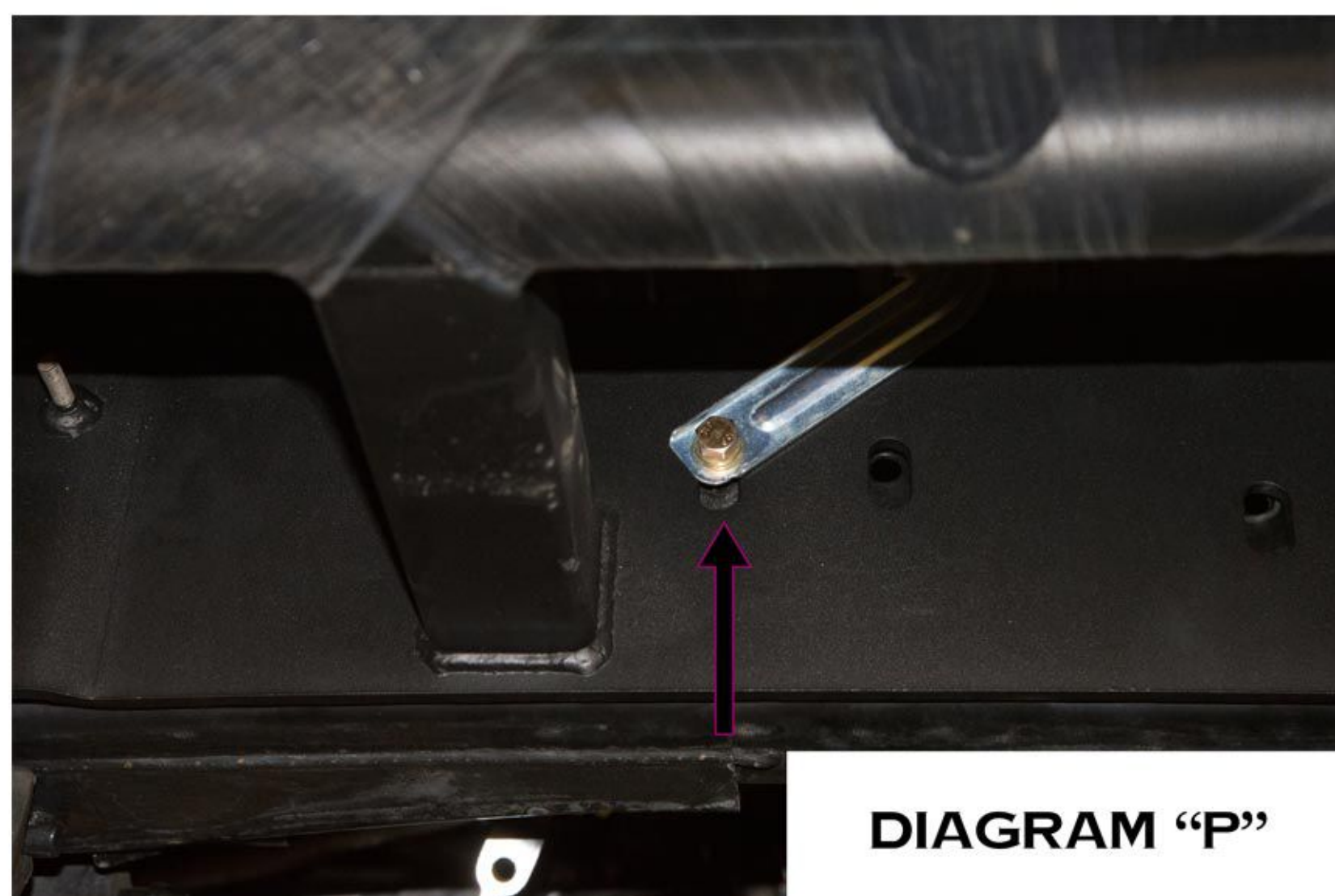

DIAGRAM "P"



RSG METAL WORKS
720.523.3999
ORDERS@RSGOFFROAD.COM

13. YOU MAY HAVE TO SLIGHTLY BEND THE BRAKE LINES TO FIT THE NUT PLATE BEHIND THE FRAME, SHOWN IN DIAGRAM "Q". THERE IS ONE ADDITIONAL NUT PLATE NEEDED, YOU WILL NEED TO REACH BACK INTO THE FRAME AND LINE UP THE NUT PLATE WITH THE BOLT HOLE, AS SHOWN IN DIAGRAM "R". DO NOT TIGHTEN THE HARDWARE AT THIS TIME.

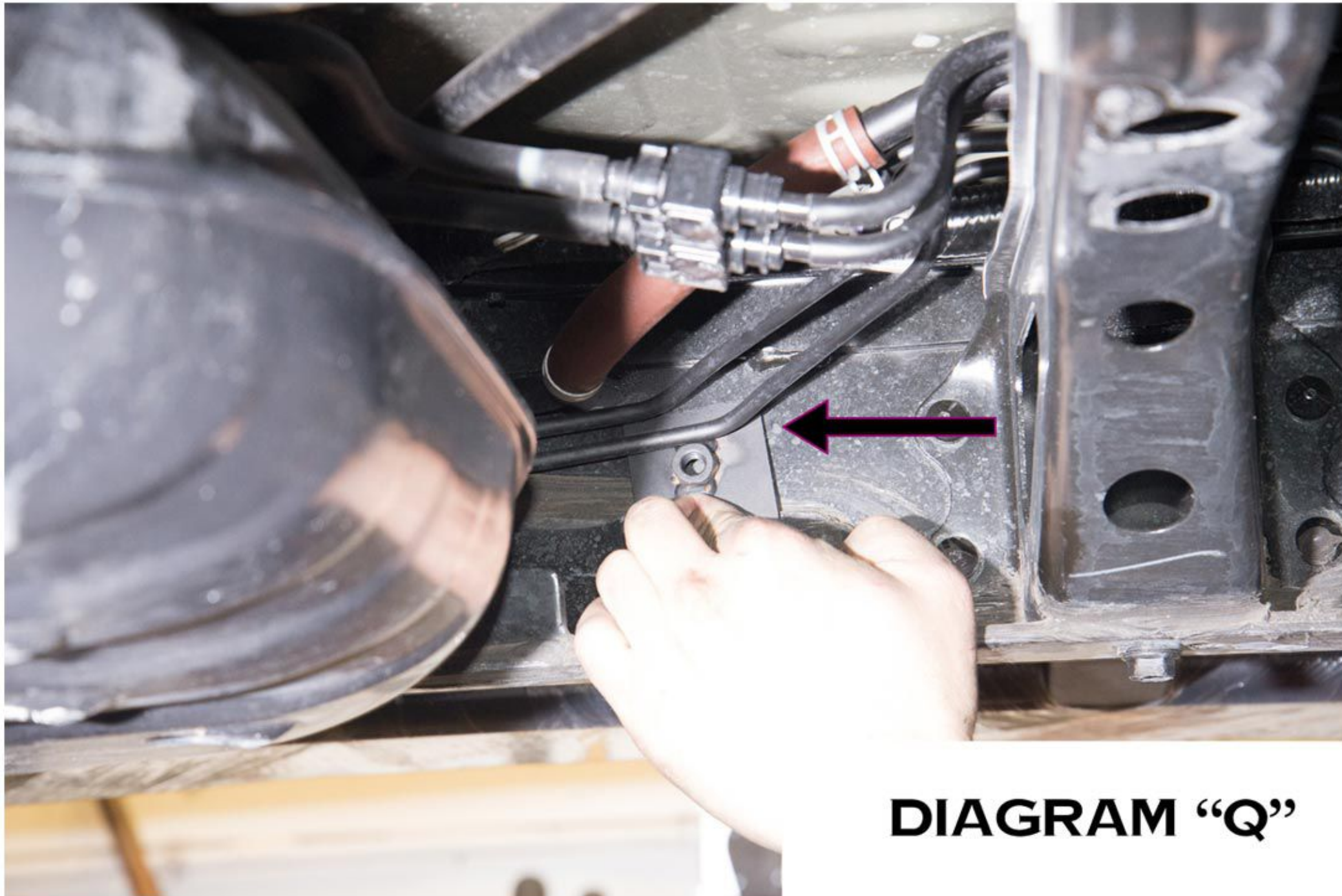

DIAGRAM "Q"

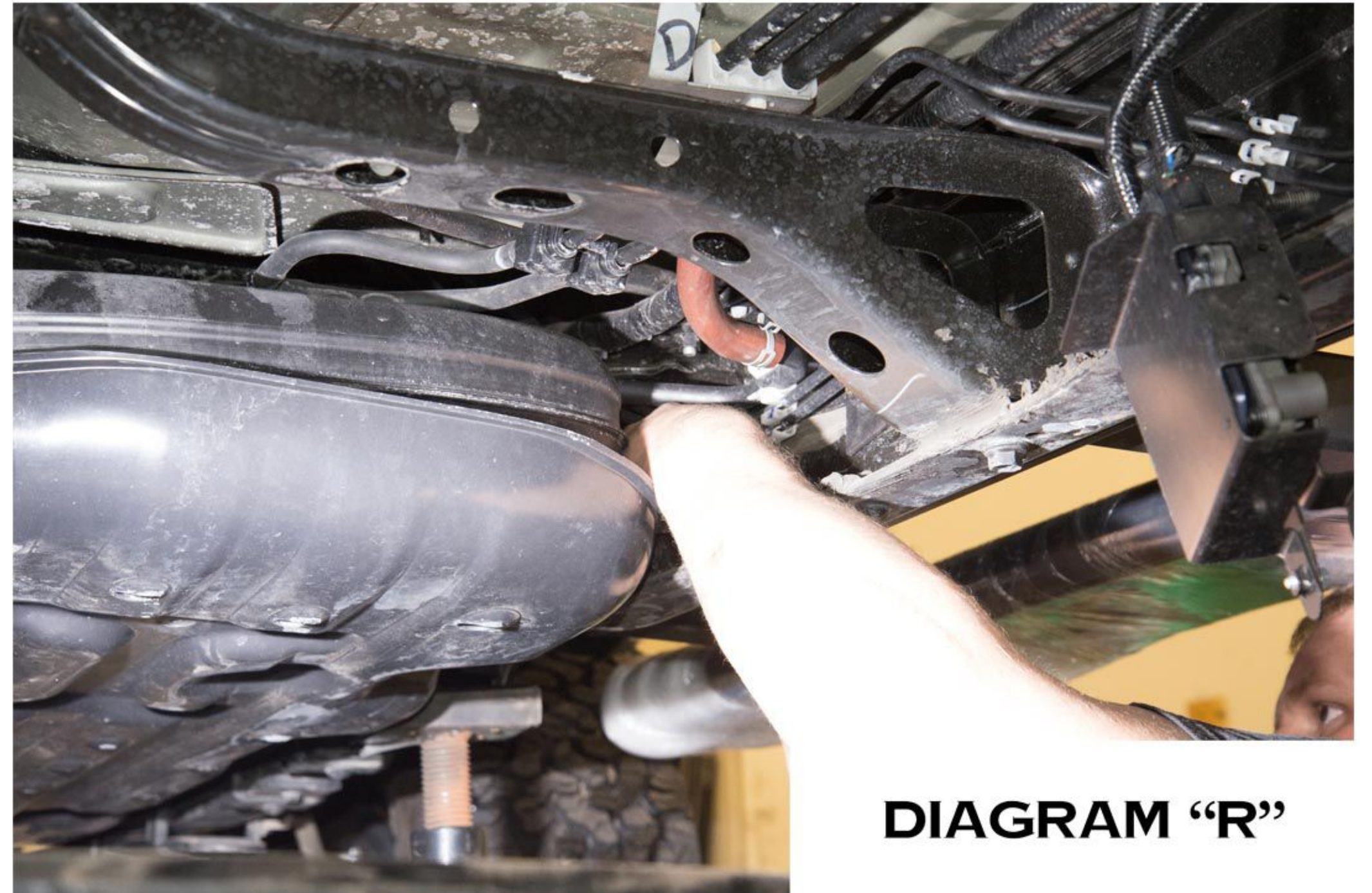

DIAGRAM "R"

14. INSTALL THE ONE SHORT BOLT SUPPLIED AND A NUT PLATE FOR BEHIND THE MODULE, AS SHOWN ON DIAGRAM "S". THEN REINSTALL MODULE WITH 2 PROVIDED METRIC WASHERS AND THE NUTS SAVED FROM STEP 10, AS SHOWN IN DIAGRAM "T". DO NOT TIGHTEN HARDWARE AT THIS TIME.

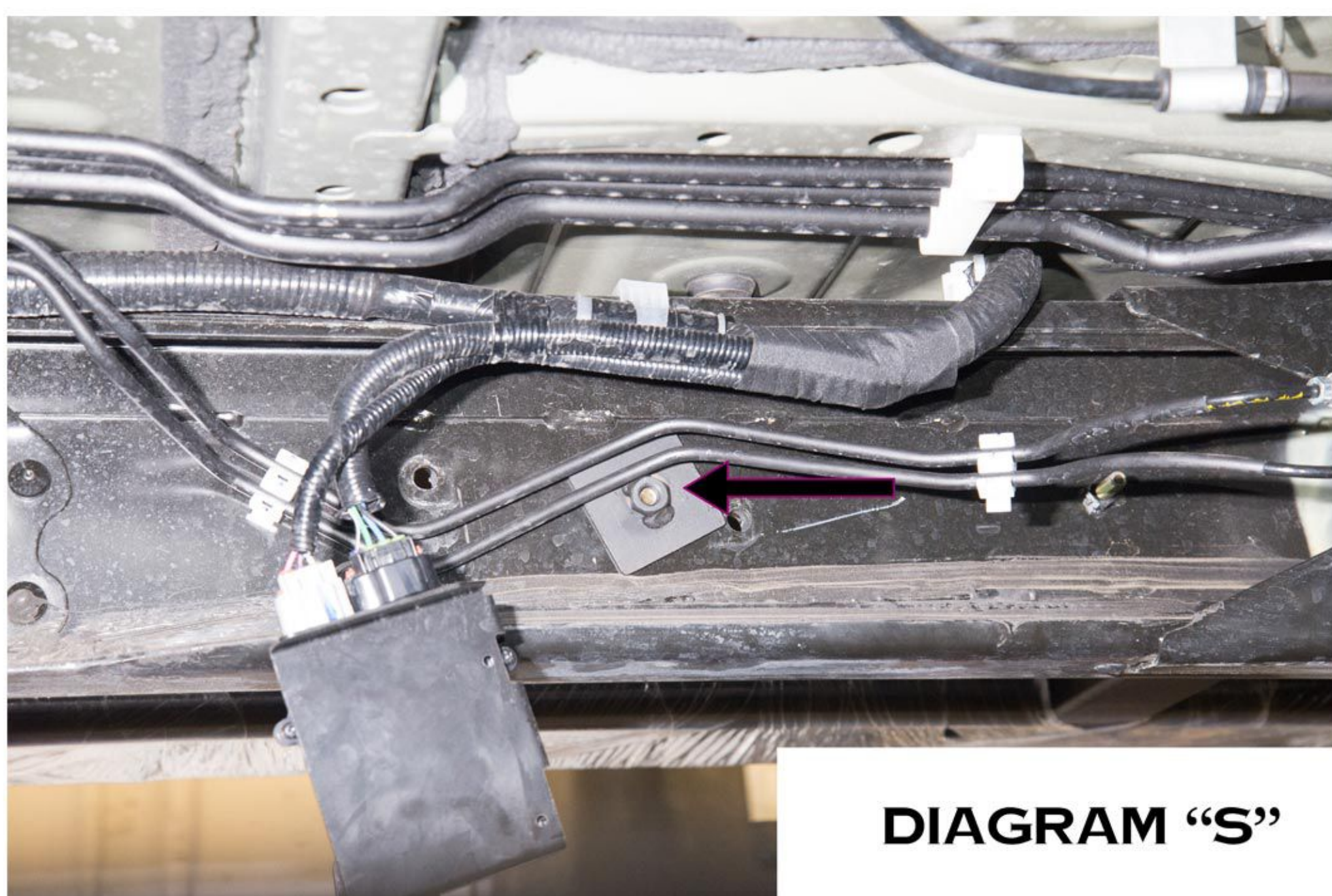

DIAGRAM "S"



DIAGRAM "T"

15. USE A MAGNET OR REACH INSIDE THE FRAME, SAME AS THE PASSENGER SIDE, TO INSTALL THE 2 NUT PLATES IN THE FRAME FOR THE 2 FRONT BOLTS ON THE SLIDER, AS SHOWN IN DIAGRAMS "U & V". ALSO ON DIAGRAM "V", YOU CAN SEE THE INSTALLATION OF THE PROVIDED WIRING HARNESS CLAMP ONTO THE WELDED STUD ON THE SLIDER'S MOUNTING PLATE.



RSG METAL WORKS
720.523.3999
ORDERS@RSGOFFROAD.COM

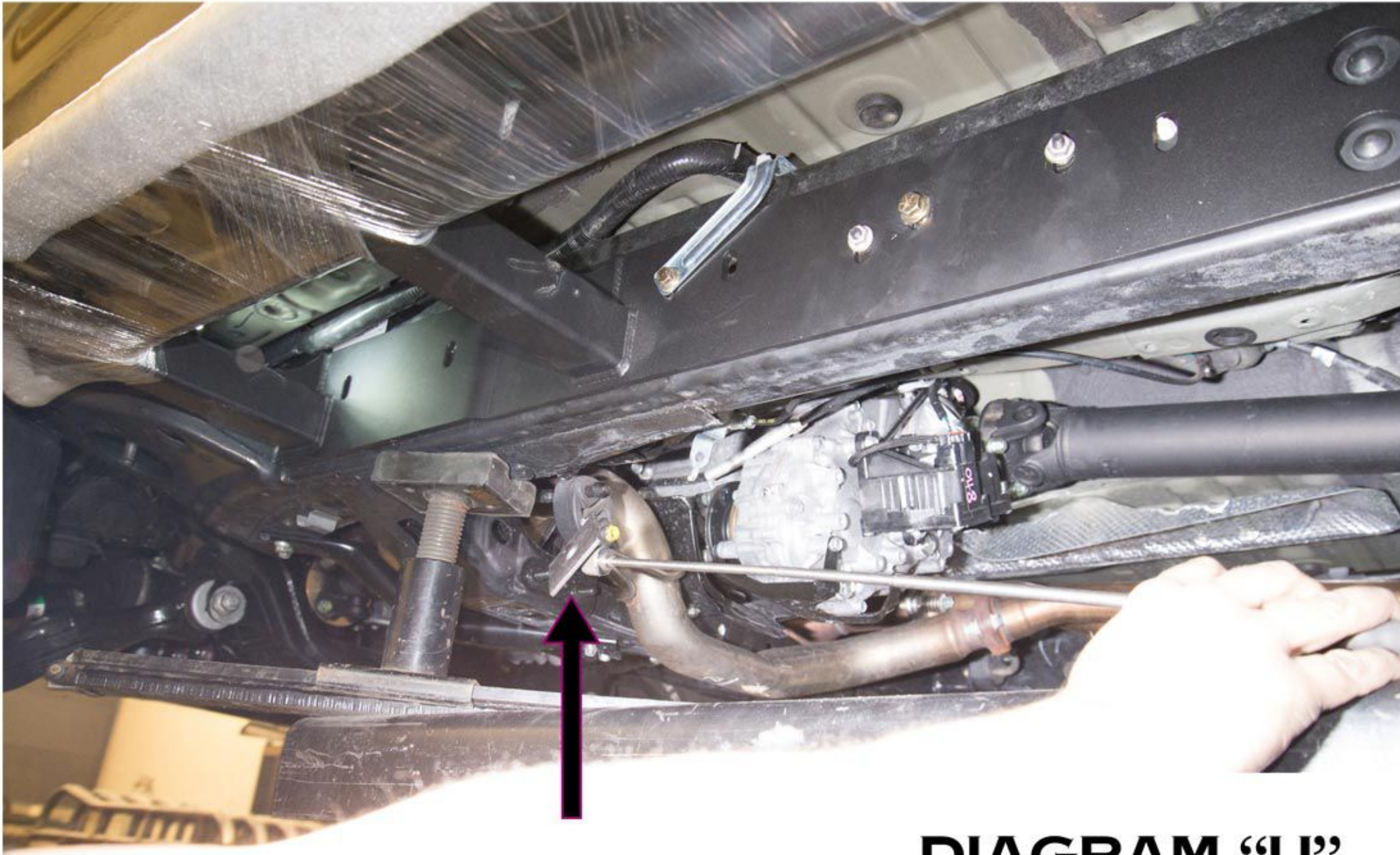

DIAGRAM "U"

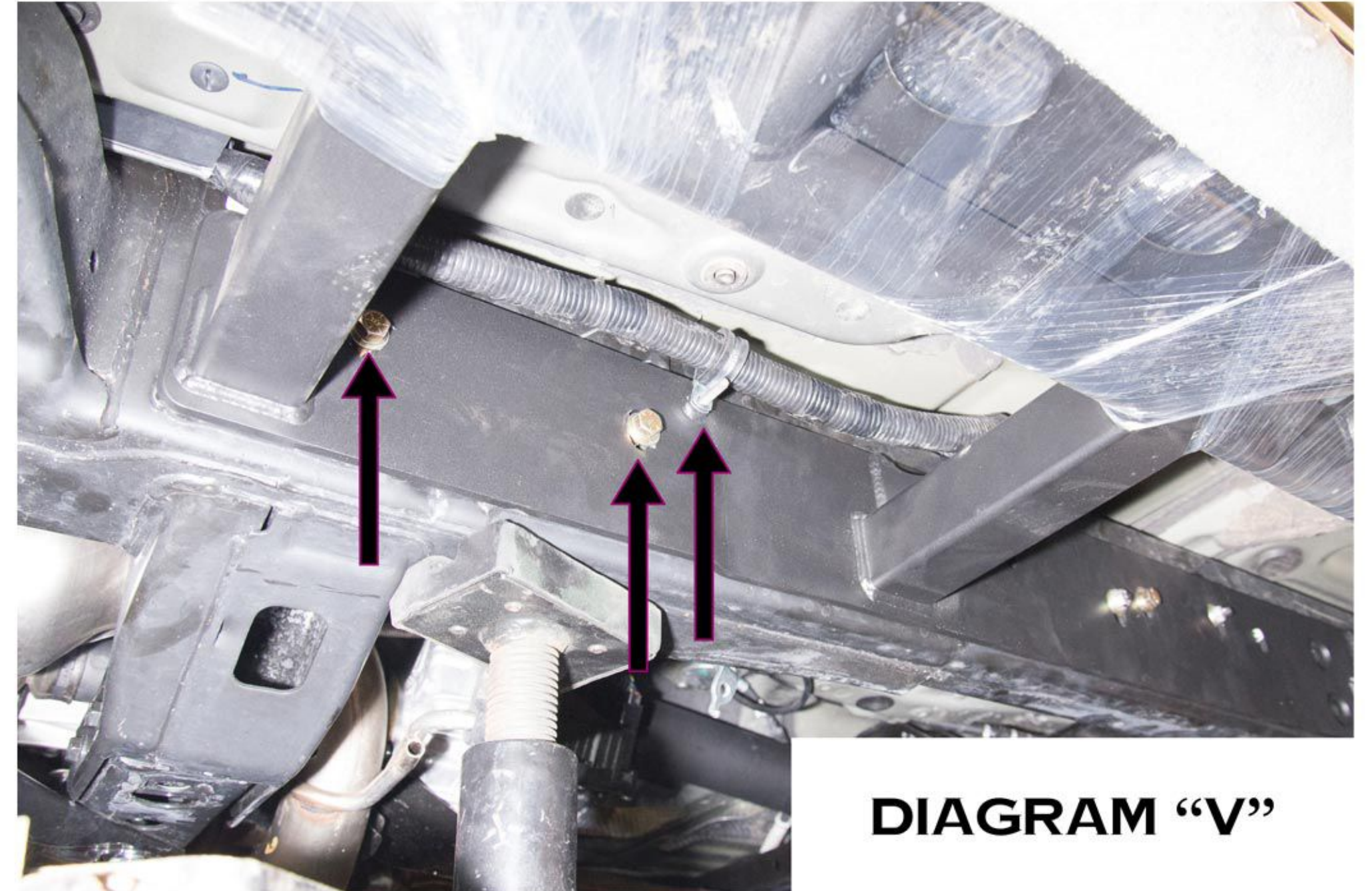

DIAGRAM "V"

16. STARTING FROM ONE END OF THE SLIDER. ADJUST THE SLIDER TO LEVEL POSITION, WORK YOUR WAY TO THE OTHER END OF THE SLIDER TIGHTENING THE HARDWARE. ONCE INSTALLED YOU WILL NEED TO REINSTALL THE PLASTIC FRAME OPENING COVER, SHOWN IN DIAGRAM "W". REINSTALL THE BRAKE LINE BRACKET AND BRAKE LINE CLIP SHOWN IN DIAGRAM "X".

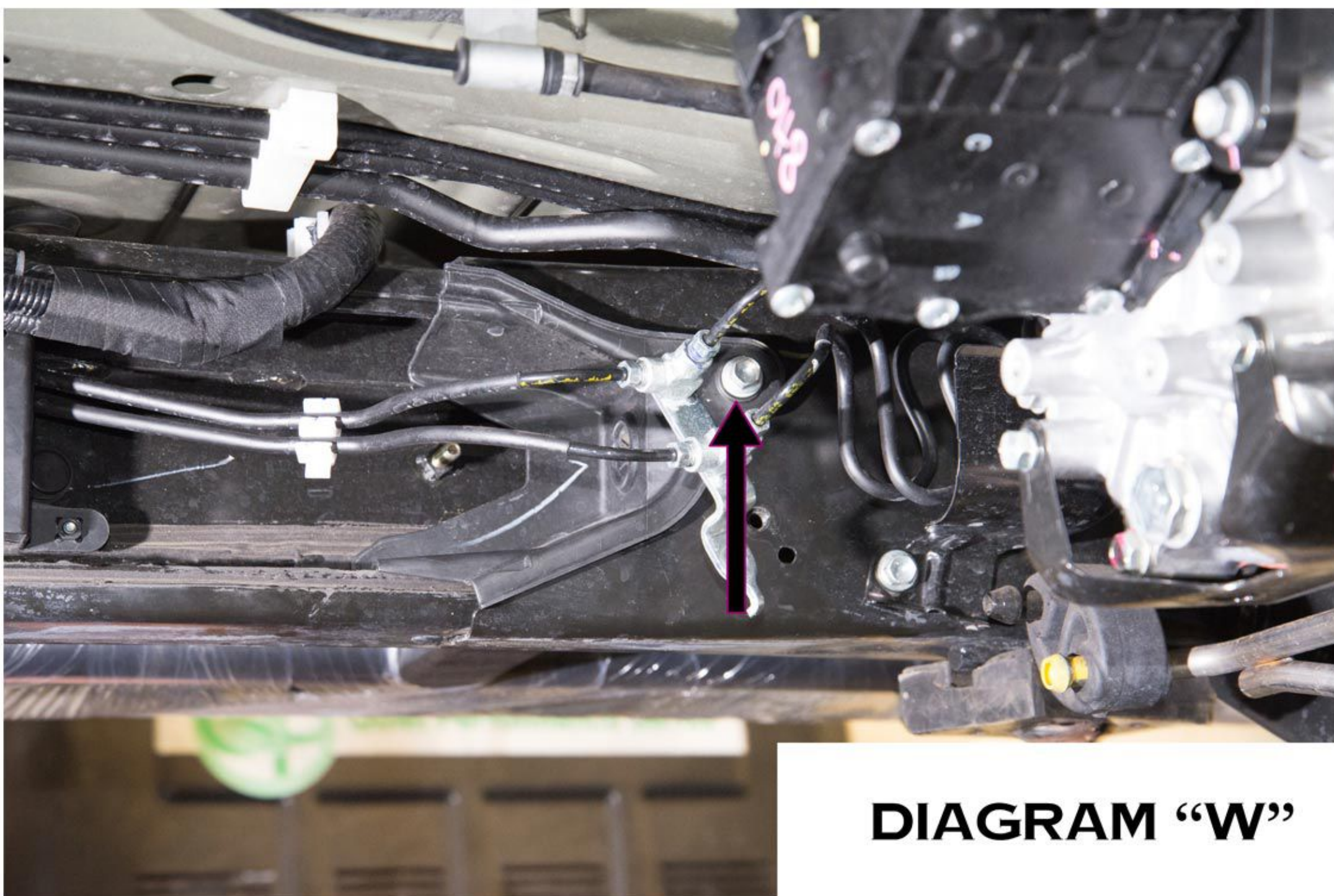

DIAGRAM "W"

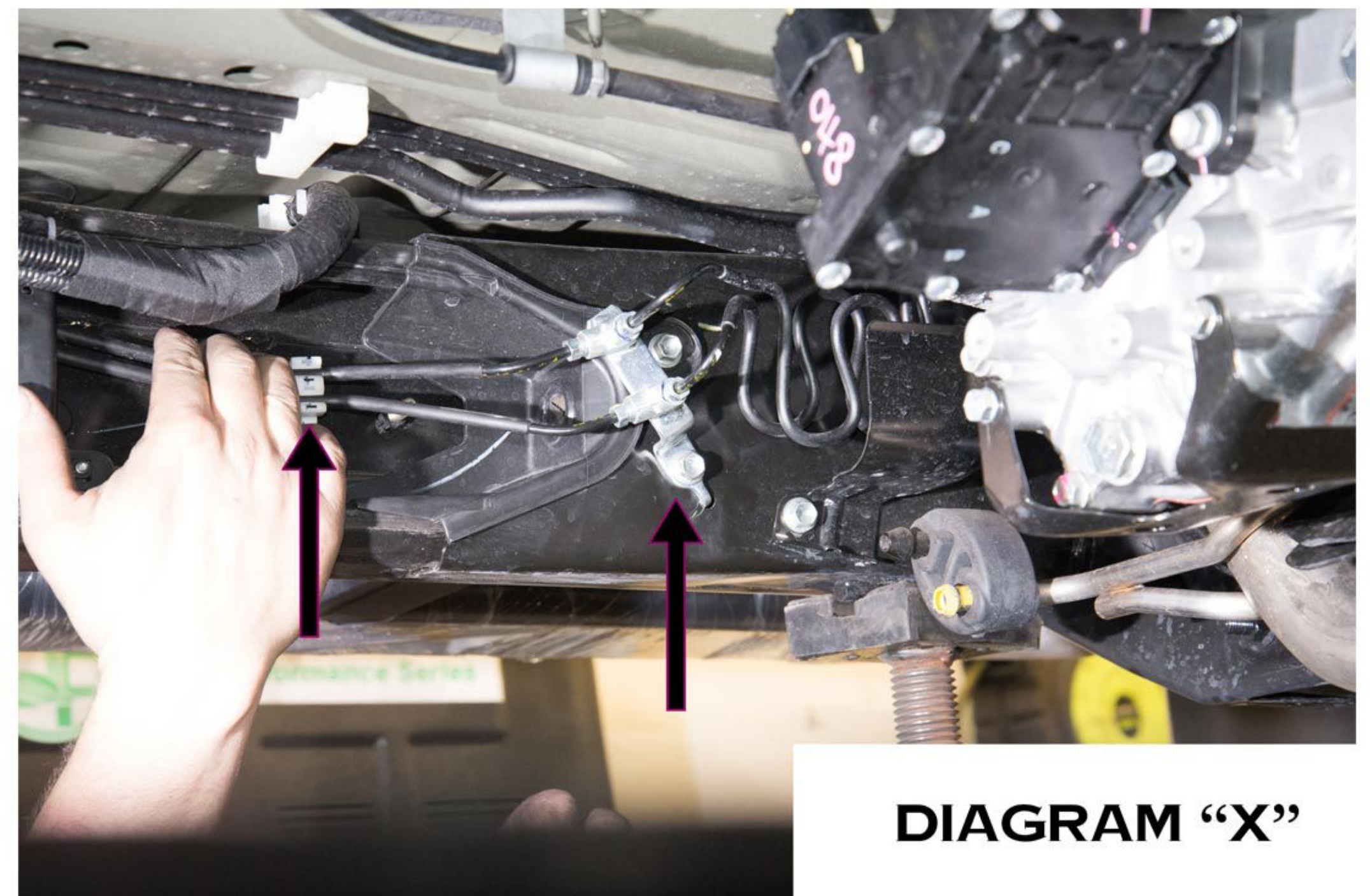

DIAGRAM "X"

17. TIGHTEN ALL BOLTS / NUTS / HARDWARE



RSG METAL WORKS
720.523.3999
ORDERS@RSGOFFROAD.COM

OPTIONAL STEPS:

THE BACK OF THE SLIDERS HAVE AN OPTIONAL BOLT LOCATION WHICH REQUIRES DRILLING. IN ORDER TO DRILL THESE LOCATIONS OUT, CENTER PUNCH THE FRAME THROUGH THE BOLT HOLE. START DRILLING WITH A 1/8" BIT AND WORK YOUR WAY UP TO A 3/8" BIT. ONCE DRILLED OUT TO A 3/8" DIAMETER, USE THE SUPPLIED HARDWARE FOR THESE LOCATIONS, AS SWOWN IN DIAGRAMS "Y & Z".

NOTE: BE EXTREMELY CAREFUL HERE NOT TO DRILL INTO YOUR GAS TANK!

INSTALLATION NOTES CAN BE FOUND ON OUR WEBSITE:
WWW.RSGMETALWORKS.COM/PAGES/INSTALL-NOTES



DIAGRAM "Y"

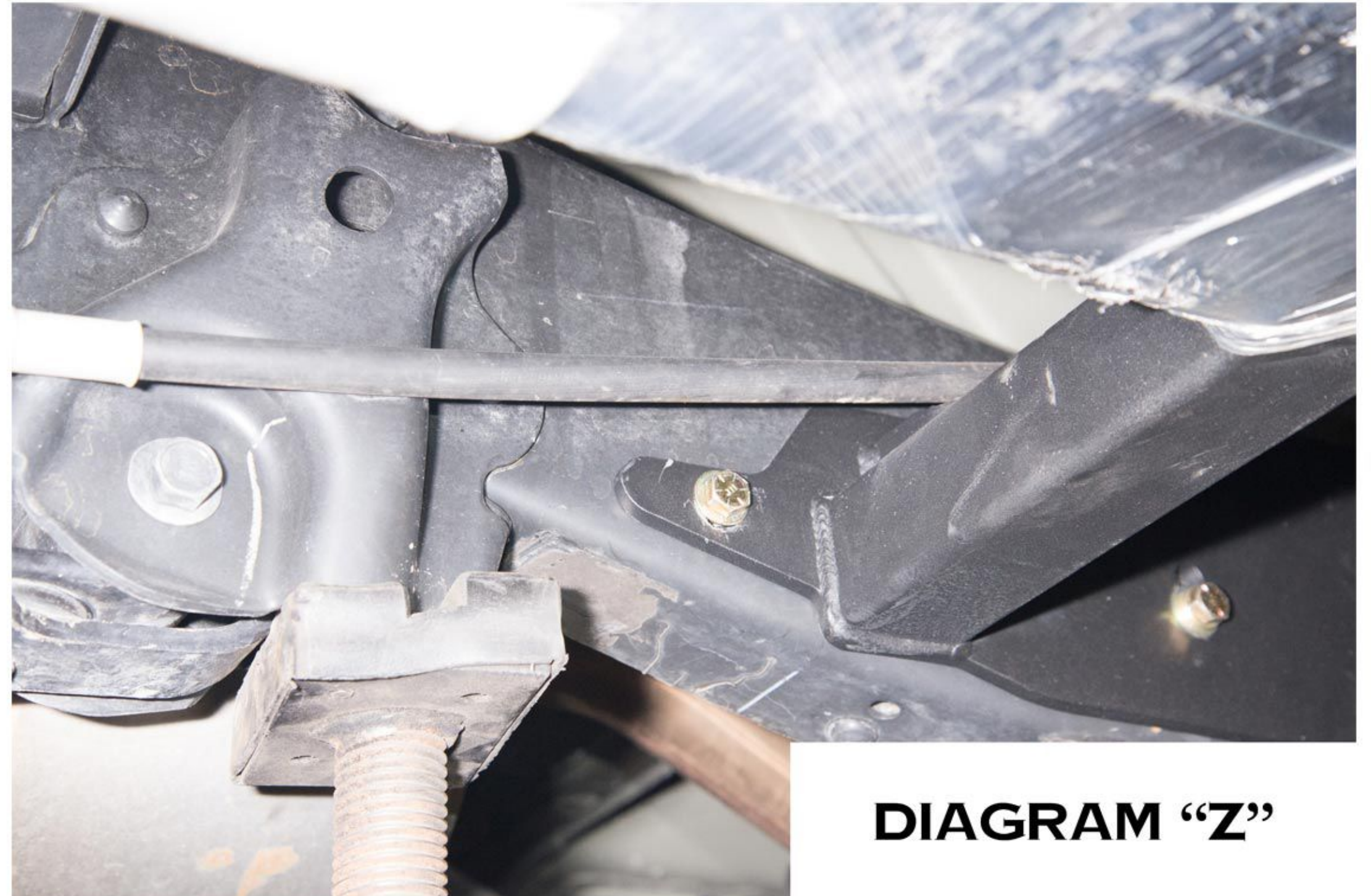
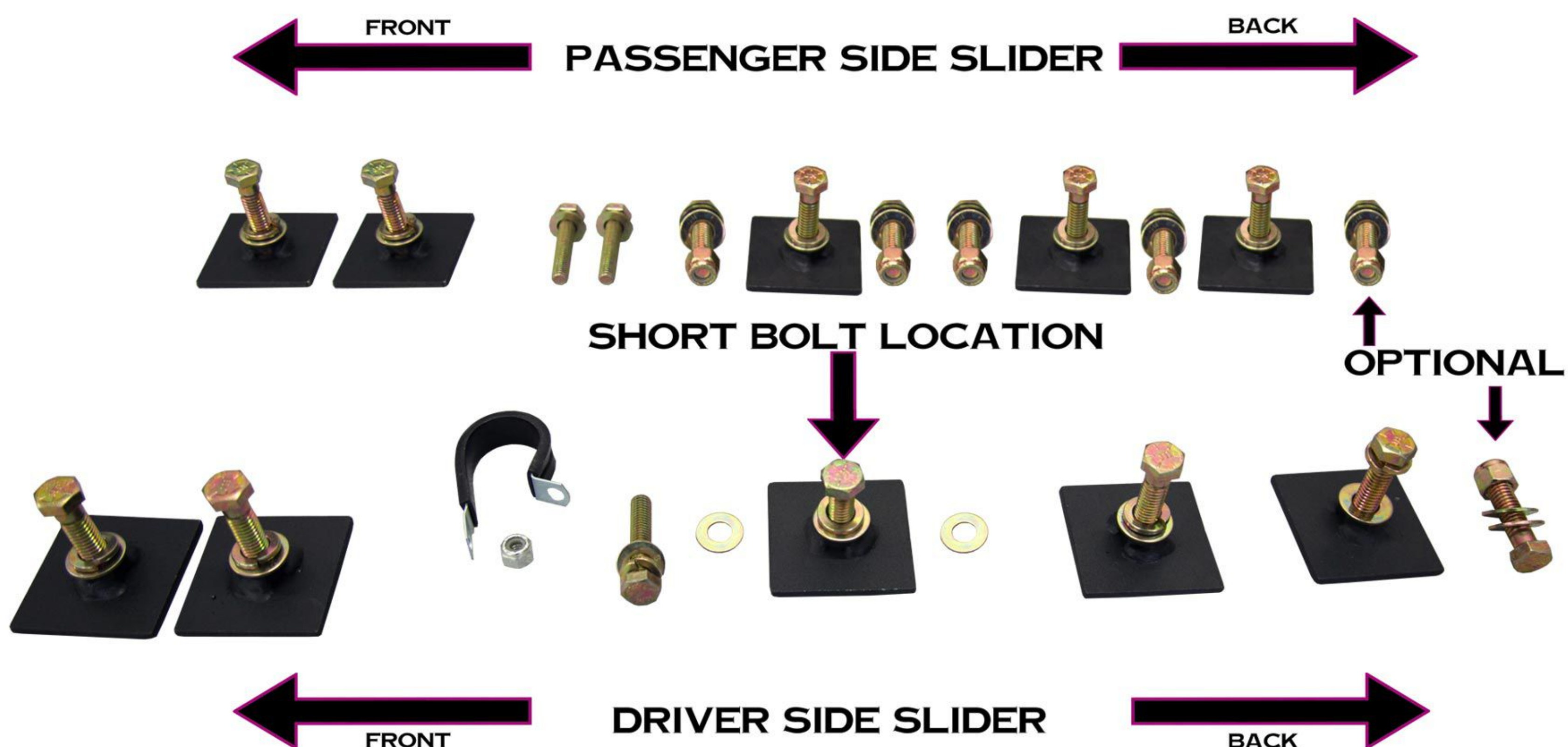

DIAGRAM "Z"

HARDWARE DIAGRAM



NOTE: THERE IS EXTRA HARDWARE SUPPLIED. SHOWN ABOVE IS ONLY WHAT IS USED FOR INSTALL AS WELL AS THE OPTIONAL BOLTS FOR THE DRILLED BOLT LOCATIONS.