

9' Cable DuraTech LE SRL

User Instruction Manual



This manual is intended to meet the Manufacturer's Instructions as required by the American National Standards Institute (ANSI) Z359 and should be used as part of an employee training program as required by the Occupational Safety and Health Administration (OSHA).

Table of Contents

1.0	Warnings and Important Information	3
2.0	Description	4
3.0	Application	5
4.0	System Requirements	6
5.0	Installation and Use	7
6.0	Maintenance, Service, and Storage	15
7.0	Inspection	15
8.0	Labels	18
9.0	Definitions	19
	Appendix A	21

For purposes of this manual, the 9' Cable DuraTech LE SRL in all iterations may be referred to collectively as the 9' DuraTech SRL-LE, the SRL-LE, the leading edge SRL, the SRL, the equipment, the device, the product, or the unit.

Throughout this manual, ANSI Z359.0-2012 fall protection words, phrases and terms are used. These terms are all formally defined in Section 9 of this manual.

1.0 Warnings and Important Information

WARNING

- Avoid moving machinery, thermal, electrical, and/or chemical hazards as contact may cause serious injury or death.
- Avoid swing falls.
- Follow the weight restrictions and recommendations in this manual.
- Remove from service any equipment subjected to fall arrest forces.
- Remove from service any equipment that fails inspection.
- Do not alter or intentionally misuse this equipment.
- Consult FallTech when using this equipment in combination with components or subsystems other than those described in this manual.
- Do not connect rebar hooks, large carabiners, or large snap hooks to the FBH dorsal D-rings as this may cause a roll-out condition and/or unintentional disengagement.
- Avoid sharp and/or abrasive surfaces and edges.
- Use caution when performing arc welding. Arc flash from arc welding operations, including accidental arcs from electrical equipment, can damage equipment and are potentially fatal.
- Examine the work area. Be aware of the surroundings and workplace hazards that may impact safety, security, and the functioning of fall arrest systems and components.
- Hazards may include, but are not limited to, cable or debris tripping hazards, equipment failures, personnel mistakes, or moving equipment such as carts, barrows, fork lifts, cranes, or dollies. Do not allow materials, tools, or equipment in transit to contact any part of the fall arrest system.
- Do not work under suspended loads.

IMPORTANT

This product is part of a personal fall arrest, restraint, work positioning, suspension, or rescue system. A Personal Fall Arrest System (PFAS) is typically composed of an anchorage and a Full Body Harness (FBH), with a connecting device, i.e., a Shock Absorbing Lanyard (SAL), or a Self-Retracting Lanyard (SRL), attached to the dorsal D-ring of the FBH.

These instructions must be provided to the worker using this equipment. The worker must read and understand the manufacturer's instructions for each component or part of the complete system. Manufacturer's instructions must be followed for proper use, care, and maintenance of this product. These instructions must be retained and be kept available for the worker's reference at all times. Alterations or misuse of this product, or failure to follow instructions, may result in serious injury or death.

A Fall Protection Plan must be on file and available for review by all workers. It is the responsibility of the worker and the purchaser of this equipment to assure that users of this equipment are properly trained in its use, maintenance, and storage. Training must be repeated at regular intervals. Training must not subject the trainee to fall hazards.

Consult a doctor if there is reason to doubt your fitness to safely absorb the shock of a fall event. Age and fitness seriously affect a worker's ability to withstand falls. Pregnant women or minors must not use this equipment.

ANSI limits the weight of fall protection equipment users to a maximum of 310 lbs. Products in this manual may have a rated capacity exceeding ANSI capacity limits. Heavy users experience more risk of serious injury or death due to falls because of increased fall arrest forces placed on the user's body. In addition, the onset of suspension trauma after a fall event may be accelerated for heavy users.

The user of the equipment discussed in this manual must read and understand the entire manual before beginning work.

NOTE: For more information consult the ANSI Z359 body of standards.

2.0 Description

The 9' Cable DuraTech LE SRL is a self-retracting device for those working at height and may be subject to Leading Edge fall hazards.

This manual includes one Appendix containing figures and tables specific to the 9' Cable DuraTech LE SRL discussed in this manual.

The SRL discussed in this manual may be attached to an overhead anchorage, i.e., from directly over the user's head, or to a maximum of 5' below the user's FBH dorsal D-ring.

Leading edge means the unprotected side and edge of a floor, roof, or formwork for a floor or other walking/working surface (such as deck) which changes location as additional floor, roof, decking, or formwork sections are placed, formed, or constructed, see Figure 1.

As shown in Figure 2 below, the 9' Cable DuraTech LE SRL has a nylon housing that contains a lifeline composed of 3/16" diameter galvanized steel wire rope, wound onto a spring tensioned drum. The SRL-LE's lifeline is equipped with a cable stop/handle assembly, and an integrated tearaway Energy Absorber. When the user is attached, the lifeline extends and retracts with user movement, automatically maintaining a taut lifeline. If a fall occurs, a centrifugal pawl system engages, stopping the lifeline payout. In a fall event, the SRL-FBH Connector will break away from the tearaway enclosure and the Energy Absorber (EA) will deploy, gradually slowing and arresting the fall.

See Table 1A in Appendix A for product and materials specifications.

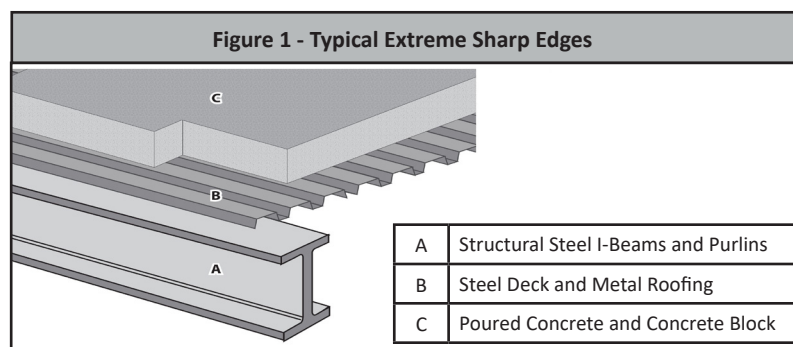

Examples not intended to depict the full extent of all hazardous sharp edges found on jobsites for the user to identify and avoid.

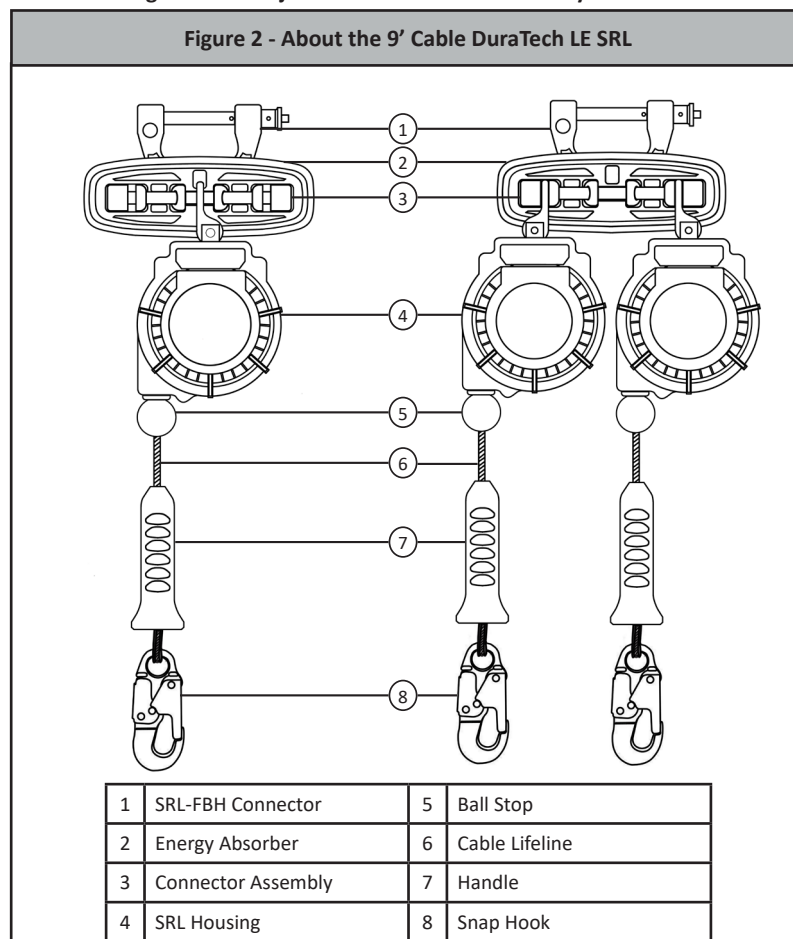

- 2.1 American National Standards Institute (ANSI) and Occupational Safety and Health Administration (OSHA):** The SRL discussed in this manual meets the standards of ANSI Z359.14-2014, ANSI A10.32-2012, and Occupational Safety and Health Administration (OSHA) regulations 1926.502. ANSI requires SRLs be classified according to their tested dynamic performance, and are classified either Class A or Class B, based on those test results. Dynamic performance means that the SRL is installed in a testing drop tower. A test weight is attached to the SRL and then dropped. Test results are recorded.

Parameters tested are:

- Arrest Distance (AD)
- Average Arrest Force (AAF)
- Maximum Arrest Force (MAF)

The Arrest Distance is the total vertical distance required to arrest a fall. The Arrest Distance includes the deceleration distance and the activation distance. The Average Arrest Force is the average of the forces applied to the body and the anchorage by the fall protection system. The Maximum Arrest Force is the maximum amount of force that may be applied to the body and the anchorage by the fall protection system. In addition to the above tests conducted in ambient conditions, the units must be retested for average and peak forces under certain environmental conditions, where the units are cooled, then tested, heated, then tested, and saturated in water and tested again. Separate units may be used for each test. All test results are recorded.

This test data is then used to establish the basis for fall clearance guidelines published in the user instruction manual.

SRL Class A and B: To be declared a Class A device, ANSI requires an SRL to have an Arrest Distance of less than 24", an Average Arrest Force of less than 1,350 lbs, (1,575 lbs conditioned) and a Maximum Arresting Force of 1,800 lbs, for both ambient and conditioned testing. To be declared a Class B device, the SRL must have an Arrest Distance of less than 54", an Average Arrest Force of less than 900 lbs, (1,125 lbs conditioned) and a Maximum Arresting Force of 1,800 lbs, for both ambient and conditioned testing.

When dynamically tested in accordance with requirements of ANSI Z359.14-2014, FallTech Class A Self-Retracting Devices have an AAF of 1,350 lbs and an AD of less than 24".

When dynamically tested in accordance with requirements of ANSI Z359.14-2014, FallTech Class B Self-Retracting Devices standard have an AAF of 900 lbs and an AD of less than 54".

Classification information found on product labels is based on test results. Table 1B and 1C provide test performance results for the SRL discussed in this manual. NOTE: Arrest distance is one of several parts of the Minimum Required Fall Clearance (MRFC). MRFC is discussed in detail in Section 5 .

The arrest distances described by Class A and Class B apply to overhead anchorage applications only. For non-overhead anchorage applications, please see Section 5 of this user instruction manual for how to calculate your Minimum Required Fall Clearance (MRFC).

3.0 Application

- 3.1 Purpose:** The 9' Cable DuraTech LE SRL is designed to be used as a component in a Personal Fall Arrest System (PFAS), to provide a combination of worker mobility and fall protection as required for inspection work, general construction, maintenance work, oil production, confined space work, etc. The 9' Cable DuraTech LE SRL is intended for fall protection in Leading Edge applications where falls may occur over leading edges.
- 3.2 Personal Fall Arrest System:** A PFAS is an assembly of components and subsystems used to arrest a person during a fall event. A PFAS typically consists of an anchorage, a deceleration device such as a Shock Absorbing Lanyard (SAL), a Self-Retracting Lanyard (SRL), or a Fall Arrestor Connecting Subsystem (FACSS), and a properly fitted Full Body Harness (FBH). Maximum permissible free fall in a typical PFAS is 6'. The Self-Retracting Devices discussed in this manual are intended for overhead use. Other applications may be below the D-ring, or horizontally in an approved FallTech SRL rotating anchor, designed for such use.
- 3.3 Horizontal Lifeline (HLL) and Rail Systems:** The SRL may be attached to rigid and flexible anchors provided that all HLL or rail system applications, installation, and uses are under the supervision of a qualified person.
- 3.4 Rescue:** Ensure a written rescue plan, method, and system is in place and readily available for rapid response. Rescues may require specialized equipment or measures. Rescue operations are beyond the scope of this manual. See ANSI Z359.4-2013.
- 3.5 Application Limits:** Take action to avoid moving machinery, sharp edges, abrasive surfaces, and thermal, electrical, including the arc from welding applications, and chemical hazards as contact may cause serious injury or death. The SRL is not designed for use in restraint, personnel riding, suspension, or work positioning. Rescue applications are beyond the scope of this manual. Do not use the SRL for these applications except as a back-up PFAS.

4.0 System Requirements

4.1 Capacity: The 9' Cable DuraTech LE SRL is designed for use by a single user with a combined weight of user, tools, clothing, etc., of 130 – 310 lbs.

4.2 Compatibility Of Connectors: Connectors are considered to be compatible with connecting elements when they have been designed to work together in such a way that their sizes and shapes do not cause their gate mechanisms to inadvertently open regardless of how they become oriented. Contact FallTech if you have any questions about compatibility. Connectors must be compatible with the anchorage or other system components. Do not use equipment that is not compatible, see Figure 3. Non-compatible connectors may unintentionally disengage. Connectors must be compatible in size, shape, and strength. Self-closing, self-locking connectors are required by ANSI and OSHA.

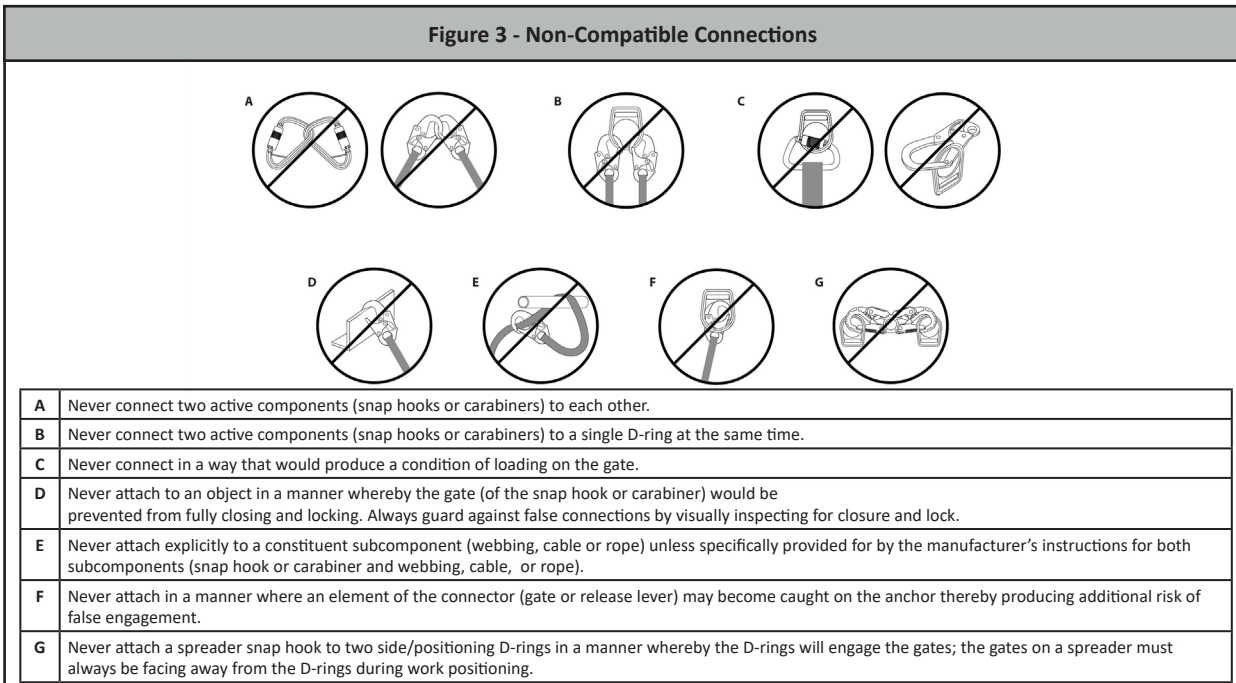

4.3 Compatibility Of Components: Equipment is designed for use with approved components and subsystems only. Substitutions or replacements made with non-approved components or subsystems may jeopardize compatibility of equipment and may affect the safety and reliability of the complete system.

4.4 Making Connections: Only use self-locking connectors with this equipment. Only use connectors that are suitable to each application. Ensure all connections are compatible in size, shape, and strength. Do not use equipment that is not compatible. Visually ensure all connectors are fully closed and locked. Connectors are designed to be used only as specified in each product's user instructions.

4.5 Personal Fall Arrest System: A PFAS is an assembly of components and subsystems used to arrest a person during a fall event. A PFAS is typically composed of an anchorage and a FBH, with an energy absorbing connecting device, i.e., an SAL, an SRL, or a Fall Arrestor Connecting Subsystem (FACSS), connected to the dorsal D-ring of the FBH. PFAS components used in conjunction with this SRL should comply with ANSI Z359 requirements and applicable OSHA regulations.

4.6 Average Arrest Force and Arrest Distance: Table 1B and 1C in Appendix A provide test data on typical performance attributes of the three principal parameters: Arrest Distance, Average Arrest Force, and Maximum Arrest Force, listed by model number and class. Testing is conducted under various environmental conditions, at ambient temperature, hot, cold, and wet conditions. In manufacturer's tests, worst case performance attributes of the SRL, connected at foot-level in a Leading Edge application with five feet of setback, or with zero setback, are:

	5' Setback	0' Setback
Longest Arrest Distance	93"	105"
Largest Average Arrest Force	965 lbs	898 lbs
Largest Maximum Arrest Force	1,264 lbs	1,624 lbs

The competent person may find this data useful with planning anchorage location and calculating fall arrest loads and distances from the walking/working level to the nearest obstruction or lower level. See Section 5.

NOTE: Arrest distance is one part of the Minimum Required Fall Clearance (MRFC). The MRFC is determined by consideration of multiple factors in fall protection. Attachment below the level of the FBH D-ring will require additional fall clearance. MRFC is discussed in detail in Section 5.

4.7 Personal Fall Arrest System Anchorage Strength: An anchorage selected for PFAS application must have the strength to sustain a static load applied in the direction permitted by the PFAS of at least:

- a. two times the maximum arrest force permitted when certification exists, or
- b. 5,000 lbs. (22.2 kN) in the absence of certification.

Select an anchorage location carefully. Consider structural strength, obstructions in the fall path, and swing fall hazards. In certain situations, the qualified person can determine that a given structure is able to withstand the applied MAF of the PFAS with a safety factor of at least two, as required by OSHA.

5.0 Installation and Use

WARNING

Do not alter or intentionally misuse this equipment. Consult FallTech when using this equipment in combination with components or subsystems other than those described in this manual. All components or subsystems used with the 9' Cable SRL-LE discussed in this manual must be in compliance with ANSI Z359 and OSHA.

Pre-Use Inspection:

Before each use, inspect the SRL-LE; See Section 7 for inspection instructions.

Use caution. Take action to avoid sharp and/or abrasive surfaces and edges when possible.

5.1 Installation to Harness

Installation for both Single Leg and Twin Leg configurations of the 9' Cable DuraTech LE SRL follow the same steps listed below:

Step 1: On the FBH, lift the dorsal D-ring to the up-pointing position, then loosen the intersection of the two web straps that pass through the D-ring slot to create slacked loops of about 2" as shown in Figure 4A. Note that some harnesses may have a built-in tunnel.

Step 2: Depress both release buttons and slide the locking bar into the open position as shown in Figure 4B.

Step 3: Attach the connector to the slacked loops by inserting the locking bar through the slacked loops as shown in Figure 4C.

Step 4: Make sure the locking bar is in the fully inserted and in the locked position, see Figure 4D.

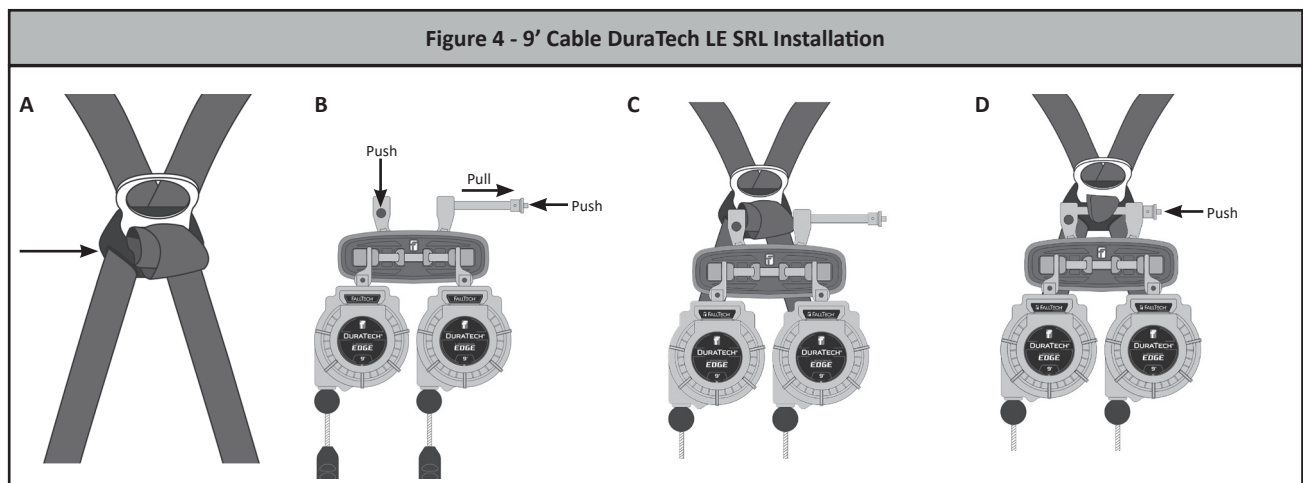

5.2 Attaching to an Anchorage

Examine the work area for possible hazards. Take caution to avoid overhead hazards such as cranes, poles, overhead power cables, and walking/working surface hazards such as power cables, welding leads, air and fluid hoses, including obstruction hazards such as vertical columns and stacks of materials on the lower level. Eliminate hazards where possible.

Ensure the anchorage provides the Minimum Required Fall Clearance (MRFC) in the fall path below the walking/working surface to prevent striking the lower level or an obstruction during a fall event. Take action to avoid swing falls, which occur when the anchorage is not directly above the point where the fall occurs.

Fall clearance and swing falls are subject to variable conditions. Anchor height, lateral movement, and setback distance all affect anchor location with regard to fall clearance and swing falls.

The SRL may be attached to an overhead anchor, i.e., above the user's FBH dorsal D-ring, or a non-overhead anchor, i.e., below the user's FBH dorsal D-ring. A non-overhead anchor may be a maximum of 5' below the user's FBH dorsal D-ring. Non-overhead anchor locations result in greater contact between the lifeline and the edge and present greater abrasion risk hazards.

Use of a below D-ring anchorages should be as a last resort, when no other anchor option exists.

Performance testing has shown that a fall event over a leading edge will alter SRL performance characteristics and fall clearance requirements. When anchored below the FBH back D-ring, fall events will result in greater fall clearances. Reduced setback distances will also increase clearance requirements. Non-overhead anchorage when the SRL is set back less than 5' will result in the greatest MRFC and the least amount of worker mobility due to swing fall. Greater set back distances of 5' or more will reduce the overall MRFC and allow for more lateral movement of the worker when attached to a non-overhead anchorage.

If job site geometry allows it, a setback distance of 5' is recommended to take full advantage of the SRL performance. In addition, the Angle of Redirection of the lifeline, i.e., the angle of the lifeline as it passes over the edge, must be at 90 degrees or more, never less, see Figure 5.

Do not attach the anchorage connector in a manner that places the edge higher than the connector, see Figure 5.

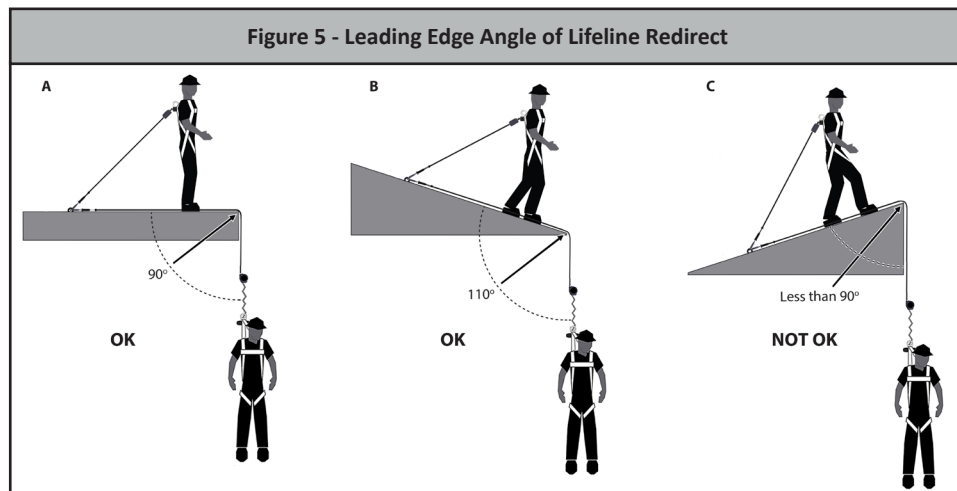

5.3 Using the 9' Cable DuraTech LE SRL

Do not use the 9' Cable DuraTech LE SRL if inspection shows damage or any malfunction.

Don the FBH (with the 9' Cable DuraTech LE SRL attached) in accordance with the harness manufacturer's instructions.

Follow the instructions contained in this manual and on the labels. Failure to follow instructions may result in serious injury or death.

Connect the leg end connector to an approved anchorage point. Ensure the connector closes and locks. In a Twin Leg configuration attach the unused leg end connector to the FBH's lanyard keeper. Ensure all connections are compatible. Normal operation will allow the working length of the lifeline to extend and retract as the worker moves about. When using a twin leg configuration, it is possible to move laterally between anchor points with 100% tie-off as shown in Figure 6.

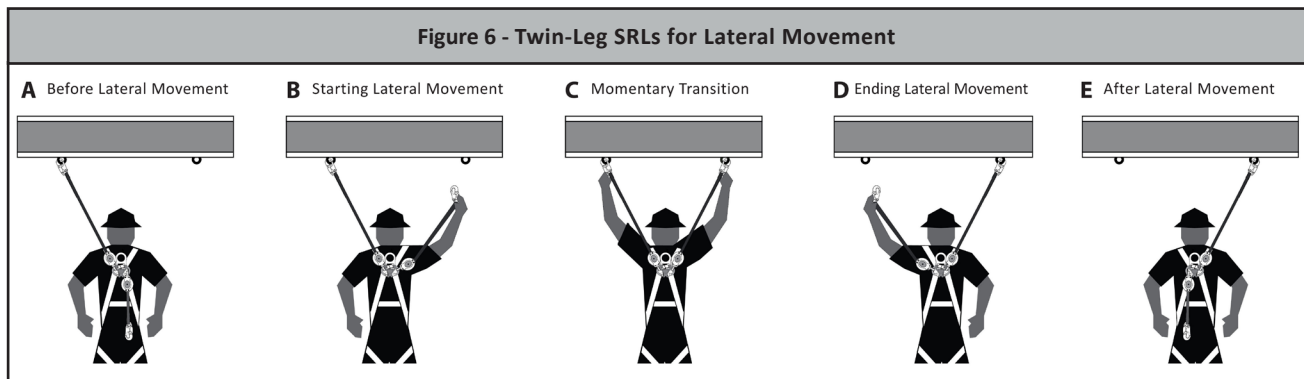

Avoid sudden or quick movements during the normal work operation, as this may cause the SRL pawl system to engage and possibly cause loss of balance, which may cause injury or death. If a fall occurs, the pawl system will engage and lock the lifeline. The EA will deploy to arrest the fall and limit arrest forces on the user.

5.4 Calculating 9' Cable DuraTech LE SRL Minimum Required Fall Clearance (MFRC)

5.4.1 **SRL-LE in Overhead, Non-Leading Edge Anchorage Application** The Leading Edge SRL may be used as a standard SRL in an overhead condition, in which the connector is installed anywhere in the allowable attachment area, which ranges from directly above the user to level with the FBH D-ring, as shown in Figure 7. The overhead condition MRFC has six metrics, labeled A – F, measured from the walking/working surface.

- A = SRL Deceleration Distance
- B = D-Ring Shift and Harness Stretch
- C = Safety Factor
- D = Sub Total- Minimum Required Fall Clearance
- E = *Additional Fall Clearance Calculation Due To Swing Fall
- F = Total Required Fall Clearance

The MRFC for an overhead anchorage, with no swing fall condition, is calculated as A+B+C=D. The user must be aware that if a swing fall hazard exists, as shown in Figure 8, additional steps are required. Use Chart 1 on the following page to determine the amount of swing fall, and place that value in E. Add the E value to the D value to determine the total fall clearance required.

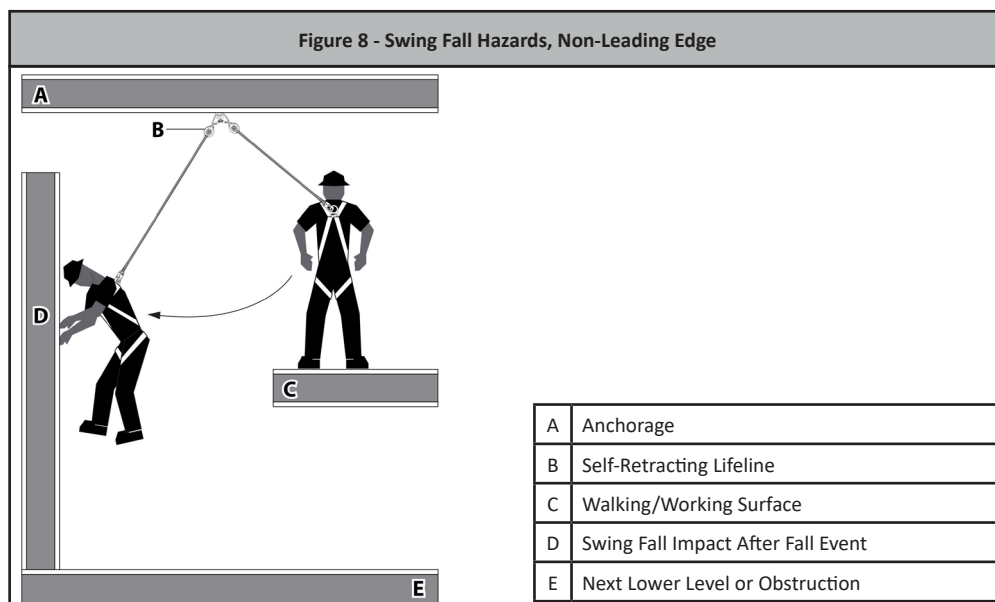
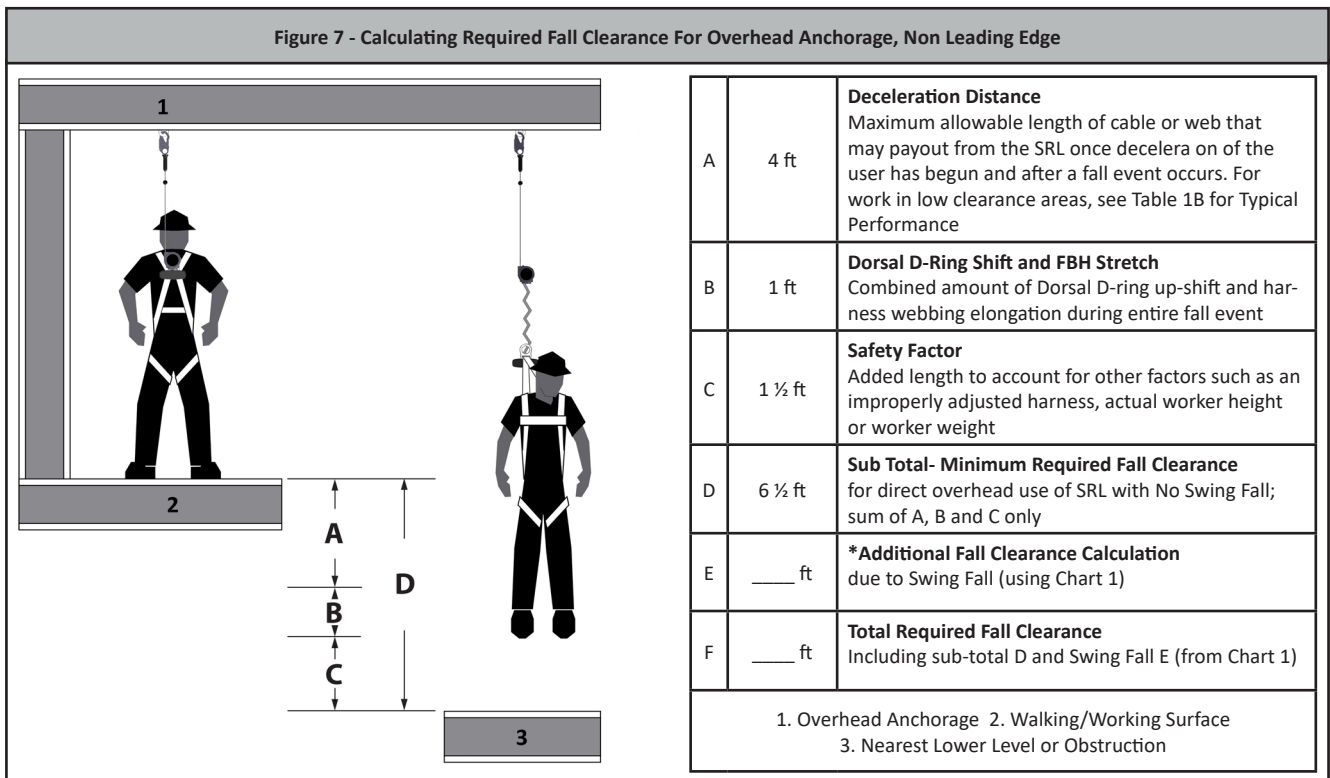

Chart 1 - Additional Fall Clearance Due To Swing Fall for Overhead Anchorage, Non Leading Edge

Y-Axis: SRL Anchorage Height Above D-Ring of FBH (ft)	9	0	0	0	0	1	1	2	2	3	4
	8	0	0	0	1	1	1	2	3	3	4
	7	0	0	0	1	1	2	2	3	4	4
	6	0	0	0	1	1	2	2	3	4	5
	5	0	0	0	1	1	2	3	4	4	5
	4	0	0	0	1	2	2	3	4	5	6
	3	0	0	1	1	2	3	4	5	6	7
	2	0	0	1	2	2	3	4	5	6	7
	1	0	0	1	2	3	4	5	6	7	8
	Dorsal D-Ring	0	0	1	2	3	4	5	6	7	8

0	1	2	3	4	5	6	7	8	9
---	---	---	---	---	---	---	---	---	---

X-Axis: Lateral Work Zone (ft)

Using Chart 1 to Find Additional Fall Clearance for Overhead Anchorage

1 foot increments along the X-Axis represent the distance the user is working away from the SRL Anchorage

1 foot increments up the Y-Axis represent the SRL Anchorage height above or below the user's Dorsal D-Ring

To find the additional Fall Clearance needed to compensate for potential Swing Fall, note the starting location on Chart 1 titled **Dorsal D-Ring**

Example:

If the user needs to work 7' away from directly under the SRL, the SRL needs to be anchored at least 4' above the user's Dorsal D-Ring therefore, 4' of additional fall clearance should be added to the Sub-total calculation in Figure 7.

Example:

If the only suitable overhead Anchorage for the SRL is 1' above the user's Dorsal D-Ring, the maximum allowable work zone is 5' away from directly overhead therefore, 4 feet of additional fall clearance should be added to the sub-total calculation in Figure 7.

Key to Work Zone Areas:



= Allowable Use Area



= Cautionary Use Area



= Not Allowed Use Area

5.4.2 5' Setback From Leading Edge and 5' Below the Dorsal D-Ring Anchorage

With the anchor set back and below the D-ring, as shown in Figure 9, there are six variables to consider when calculating the MRFC. These six are labeled A, B, C, D, E, and F. G is the MRFC.

These variables are:

- A = 5' Setback SRL-LE Deceleration Distance (See Appendix A)
- B = Dorsal D-Ring Shift and FBH Stretch
- C = Dorsal D-Ring Height
- D = Safety Factor
- E = Sub Total-Minimum Required Fall Clearance
- F = *Additional Fall Clearance Calculation for Swing Fall – 4' Maximum
- G = Total Required Fall Clearance

Use Figure 9 as a worksheet. The MRFC for this anchorage geometry is calculated as $A+B+C+D=E$. E is the Sub Total-MRFC. This total does NOT account for swing fall. If a swing fall condition exists, use Chart 2 to determine "F", the additional fall clearance needed. $E+F=G$ is the total fall clearance required.

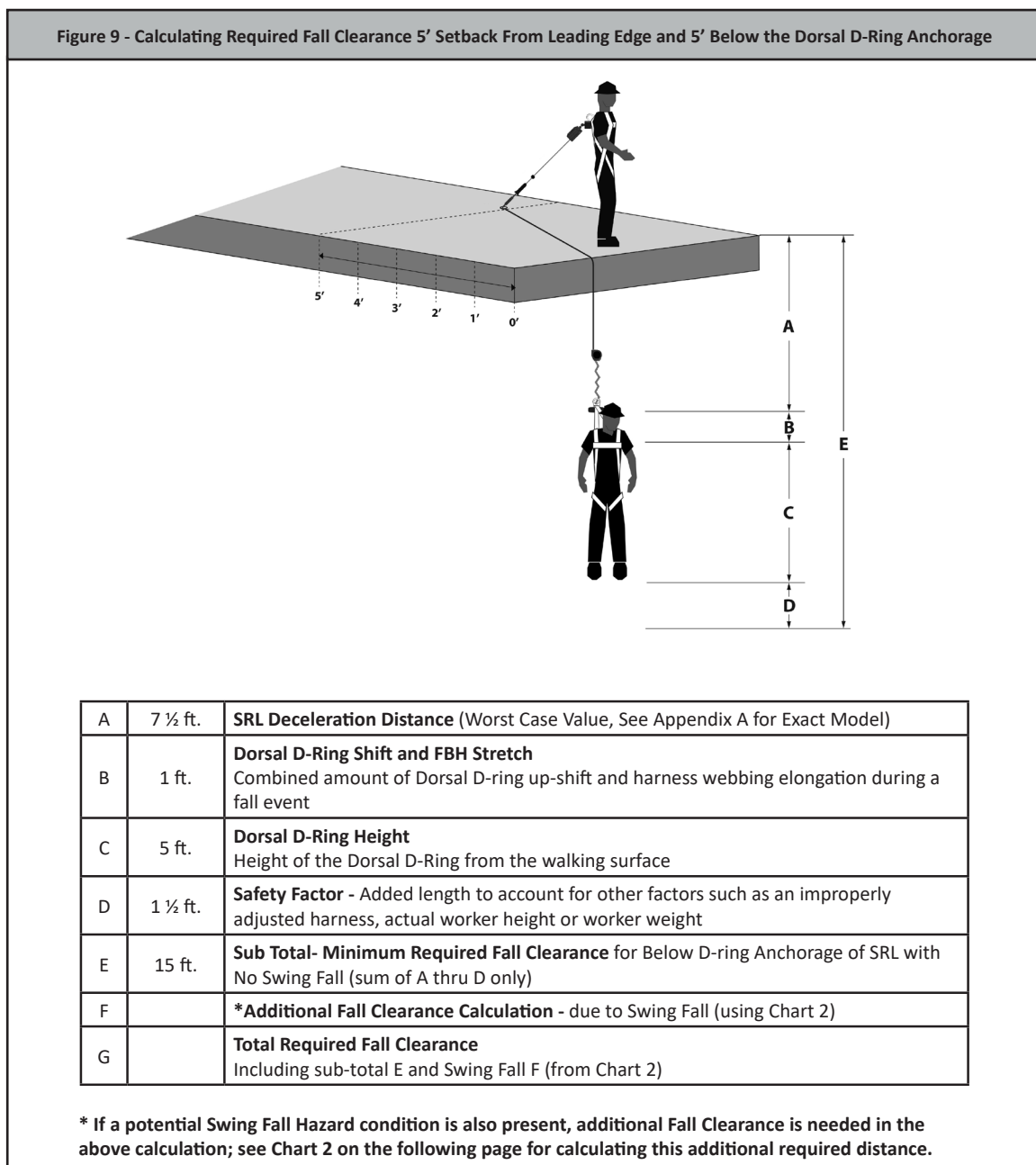

Chart 2 - Additional Fall Clearance Due To Swing Fall with 5' Setback from Leading Edge and Foot Level Anchorage

Y-Axis: SRL Anchorage Height Above D-Ring of FBH (ft)	9	0	0	0	0	1	1	2	2	3	3
	8	0	0	0	0	1	1	2	2	3	4
	7	0	0	0	1	1	1	2	2	3	4
	6	0	0	0	1	1	1	2	3	3	4
	5	0	0	0	1	1	2	2	3	4	4
	4	0	0	0	1	1	2	2	3	4	5
	3	0	0	0	1	1	2	3	3	4	5
	2	0	0	0	1	1	2	3	3	4	5
	1	0	0	0	1	1	2	3	4	4	5
	Dorsal D-Ring	0	0	0	1	1	2	3	4	4	5
Height Below D-Ring of FBH (ft)	-1	0	0	0	1	1	2	3	4	4	5
	-2	0	0	0	1	1	2	3	3	4	5
	-3	0	0	0	1	1	2	3	3	4	5
	-4	0	0	0	1	1	2	2	3	4	5
	-5	0	0	0	1	1	2	2	3	4	5
	0	1	2	3	4	5	6	7	8	9	
X-Axis: Lateral Work Zone (ft) →											

Using Chart 2 to Find Additional Fall Clearance: Leading Edge Conditions

2 foot increments along the X-Axis represent the distance the user is working away from the SRL Anchorage

5 foot increments up the Y-Axis represent the SRL Anchorage height above or below the user's Dorsal D-Ring

At no time shall the expanded Work Zone exceed 8' (8' on each side of center)

To find the additional Fall Clearance needed to compensate for potential Swing Fall, note the starting location on Chart 2 titled **Dorsal D-Ring**

Example:

The starting point shown is where the SRL is anchored at Foot Level (5' below the Dorsal D-ring) and has 5' of Setback distance from the Leading Edge. From here, the user may expand the lateral work zone up to 8' along the X-axis and still remain inside the allowable and cautionary areas. This expanded work zone indicates that 4' of additional fall clearance should be added to the Sub-total calculation in **Figure 9**.

Should the user need to expand the work zone to 9', the SRL must be anchored 5' above the Dorsal D-ring to remain in the allowed and cautionary areas. This change also indicates 4' of additional fall clearance should be added in **Figure 9**.

If the user cannot anchor the SRL above the Dorsal D-ring but still must expand the work zone, the SRL will need to be anchored with more than 5' of setback distance from the leading edge.

Key to Work Zone Areas: = Allowable Use Area = Cautionary Use Area = Not Allowed Use Area

5.4.3 0' Setback From Leading Edge and 5' Below the Dorsal D-Ring Anchorage

With the anchor installed at zero set back and below the D-ring, as shown in Figure 10, there are six variables to consider when calculating the MRFC. These six metrics are labeled A, B, C, D, E, and F. These metrics are:

- A = 0' Setback SRL-LE Deceleration Distance (See Appendix A)
- B = Dorsal D-Ring Shift and FBH Stretch
- C = Dorsal D-Ring Height
- D = Safety Factor
- E = Sub Total-Minimum Required Fall Clearance
- F = *Additional Fall Clearance Calculation for Swing Fall – 4' Maximum
- G = Total Required Fall Clearance

Use Figure 10 as a worksheet. The MRFC for this anchorage geometry is calculated as $A+B+C+D=E$. F is the Sub Total-MRFC. This total does NOT account for swing fall. If a swing fall condition exists, use Chart 3 to determine "F", the additional fall clearance needed. $E+F=G$ is the total fall clearance.

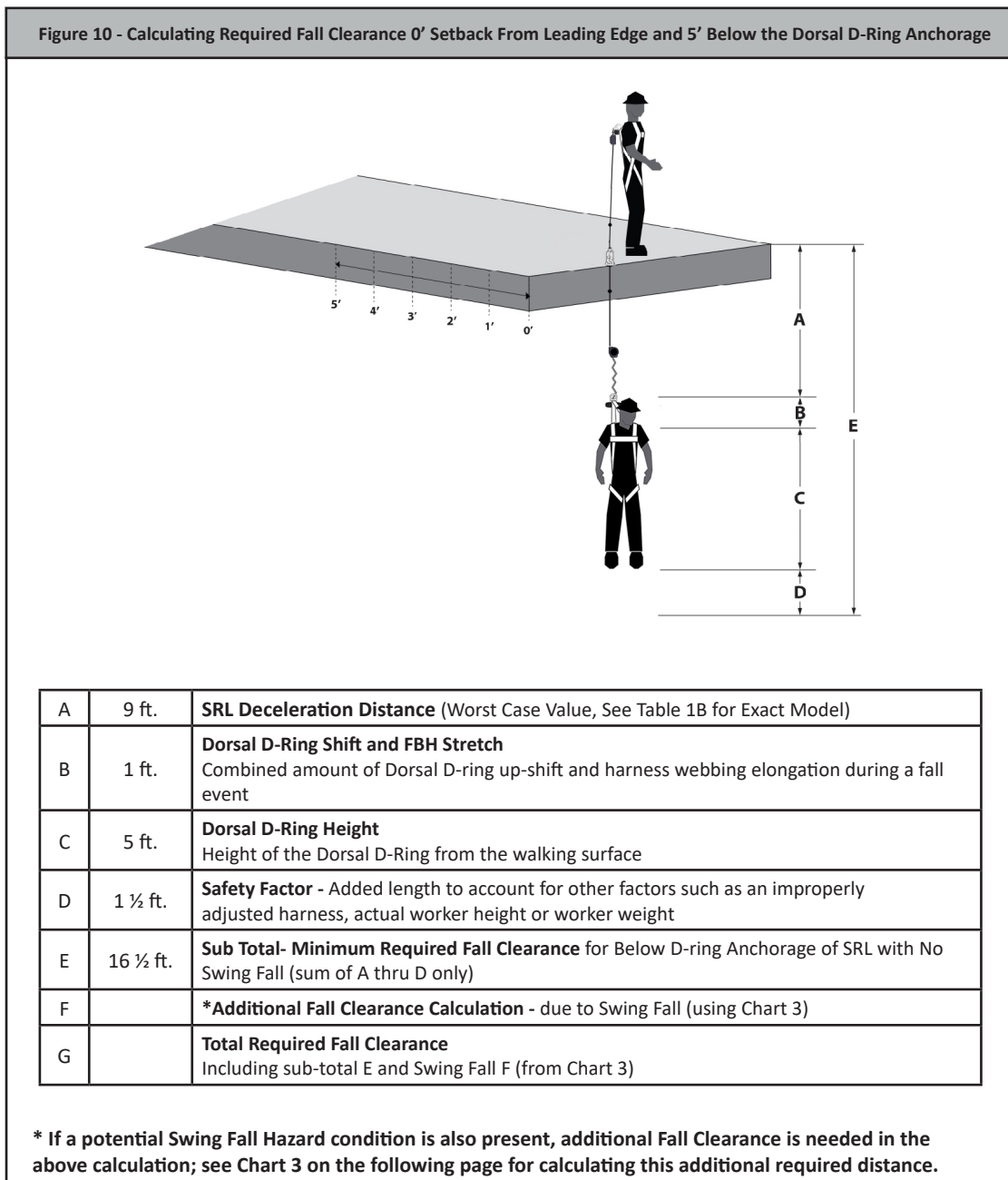

Chart 3 - Additional Fall Clearance Due To Swing Fall with 0' Setback from Leading Edge and Foot Level Anchorage

Y-Axis: SRL Anchorage Height Above D-Ring of FBH (ft)	9	0	0	0	0	1	1	2	2	3	4
	8	0	0	0	1	1	1	2	3	3	4
	7	0	0	0	1	1	2	2	3	4	4
	6	0	0	0	1	1	2	2	3	4	5
	5	0	0	0	1	1	2	3	4	4	5
	4	0	0	0	1	2	2	3	4	5	6
	3	0	0	1	1	2	3	4	5	6	6
	2	0	0	1	2	2	3	4	5	6	7
	1	0	0	1	2	3	4	5	6	7	8
	Dorsal D-Ring	0	0	1	2	3	4	5	6	7	8
Height Below D-Ring of FBH (ft)	-1	0	0	1	2	3	4	5	6	7	8
	-2	0	0	1	2	2	3	4	5	6	7
	-3	0	0	1	1	2	3	4	5	6	6
	-4	0	0	0	1	2	2	3	4	5	6
	-5	0	0	0	1	2	2	3	4	5	6
		0	1	2	3	4	5	6	7	8	9
X-Axis: Lateral Work Zone (ft)		→									

Using Chart 3 to Find Additional Fall Clearance: Leading Edge Conditions

1 foot increments along the X-Axis represent the distance the user is working away from the SRL Anchorage

1 foot increments up the Y-Axis represent the SRL Anchorage height above or below the user's Dorsal D-Ring

At no time shall the expanded Work Zone exceed 7' (7' on each side of center)

To find the additional Fall Clearance needed to compensate for potential Swing Fall, note the starting location on Chart 3 titled **Dorsal D-Ring**

Example:

The starting point shown is where the SRL is anchored at Foot Level (5' below the Dorsal D-ring) and has 0' of Setback distance from the Leading Edge. From here, the user may expand the lateral work zone up to 7' along the X-axis and still remain inside the allowable and cautionary areas. This expanded work zone indicates that 4' of additional fall clearance should be added to the Sub-total calculation in **Figure 10**.

Should the user need to expand the work zone to 9', the SRL must be anchored 7' above the Dorsal D-ring to remain in the allowed and cautionary areas. This change also indicates 4' of additional fall clearance to be added to **Figure 10**.

If the user cannot anchor the SRL above the Dorsal D-ring but still must expand the work zone, the SRL will need to be anchored with more than 5' of setback distance from the leading edge.

Key to Work Zone Areas: = Allowable Use Area = Cautionary Use Area = Not Allowed Use Area

6.0 Maintenance, Service, and Storage

6.1 Maintenance: Ensure the SRL is kept free of excess paint, grease, dirt or other contaminants as this may cause the cable or retracting mechanism to malfunction. Ensure no debris enters the housing through the cable access port. Clean the exterior of the unit as required with a detergent/water solution. Do not allow water or other corrosion causing elements to enter the housing. After cleaning, pull the lifeline all the way out, allow the unit to air dry, then retract the lifeline into the unit. Do not allow the lifeline to freewheel back into the housing. Clean labels as required.

DO NOT use heat to dry.

DO NOT attempt to disassemble the SRL.

6.2 Service: If service is required for any reason, such as inspection failure, impact loading, any type of malfunction, tag the unit as "UNUSABLE" and remove from service.

6.3 Storage: Store the 9' Cable DuraTech LE SRL in a cool, dry, clean environment out of direct sunlight. Position the SRL so excess water can drain out. Avoid exposure to chemical or caustic vapors. Thoroughly inspect the SRL after any period of extended storage.

7.0 Inspection

7.1 Pre-Use User Inspection: Perform an inspection before each use in accordance with the recommendations in Table 1 below.

Table 1 - Guidelines for Cable SRL Inspection		
Inspection	Pass	Fail
The cable lifeline should extract and retract completely and without faltering and should remain taut under tension without sagging.		
Extract the cable lifeline several inches and apply a firm pull to confirm the SRL locks. The locking should be certain and without skidding. Repeat this lockup at additional places along the lifeline length to confirm the SRL is operating correctly.		
Inspect the entire length of the constituent line, review the cable lifeline closely for broken strand wires, welding spatter burns, welding slag, birdcaging, kinks and bent strands. Also examine for rust, dirt, paint, grease or oil. Check for damage caused by chemical corruption or excessive heat as evident with discoloration. See Figure 11 for examples. If any of these conditions exist, remove the SRL from service.		
Examine the SRL-FBH Connector for cracks, breaks, or warping. Ensure the locking bar locks in the locked position.		
Check the Energy Absorber for rips, tears, or other damage.		
Check the Connector Assembly for cracks, deformations, or other damage.		
Examine the overall SRL unit for any indications of deterioration or damage.		
All labels must be intact and legible.		

If an inspection reveals defects or damage to the equipment, remove the equipment from service.

Extract all of the cable and check the entire working length for damage caused by chemical corruption or excessive heat as evident by discoloration (A), birdcaging (B), broken wire strands (C), kinks and bent strands (D), see Figure 11. The cable should retract completely without faltering and should remain taut under tension without sagging.

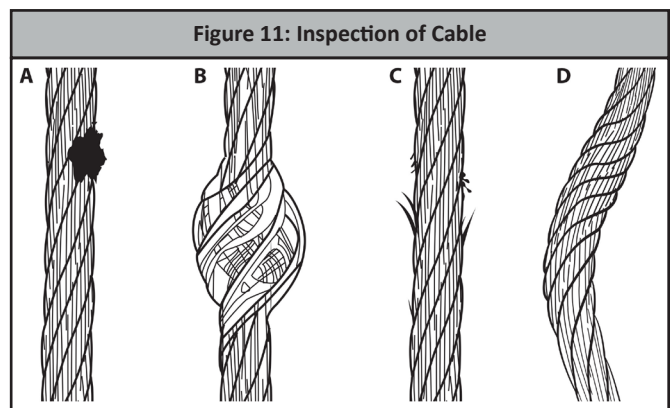

7.2 Inspection Frequency: Inspection by a competent person at regular intervals is required. The competent person will use the information in Table 2, SRL Inspection Recommendations, to determine the inspection frequency. Use Table 2 to determine the inspection frequency. Inspection by a factory authorized inspection entity at regular intervals is also recommended.

Table 2 - ANSI Z359.14-2014 SRL Inspection Recommendations			
Type of Use	Application Examples	Conditions of Use	Inspection Frequency Competent Person
Infrequent to Light Use	Rescue and Confined Space, Factory Maintenance	Good Storage Conditions, Indoor or Infrequent Outdoor use, Room Temperature, Clean Environments	Annually
Moderate to Heavy Use	Transportation, Residential Construction, Utilities, Warehouse	Fair Storage Conditions, Indoor and extended outdoor use, All temperatures, Clean or dusty environments	Semi-annually to Annually
Severe to Continuous Use	Commercial Construction, Oil and Gas, Mining	Harsh Storage Conditions, Prolonged or Continuous outdoor Use, all temperatures, Dirty environments	Quarterly to Semi-annually

7.3 Inspection Checklist: Use Table 2: Guidelines for Cable SRL Inspection to inspect the SRL. See Figure 11 for examples of cable damage.

7.4 Inspection Results: If an inspection reveals defects in or damage to the equipment, inadequate maintenance, or activated fall indicators, remove the equipment from service.

7.5 Inspection Document: Record inspection results on the Inspection Record provided below or on a similar document.

<h2 style="margin: 0;">Inspection Record</h2>					
Model #: _____		Serial #: _____		Date of Manufacture: _____	
INSPECTION DATE	INSPECTOR	COMMENTS	PASS/FAIL	CORRECTIVE ACTION NEEDED	APPROVED BY

8.0 Labels

The labels must be present and legible.

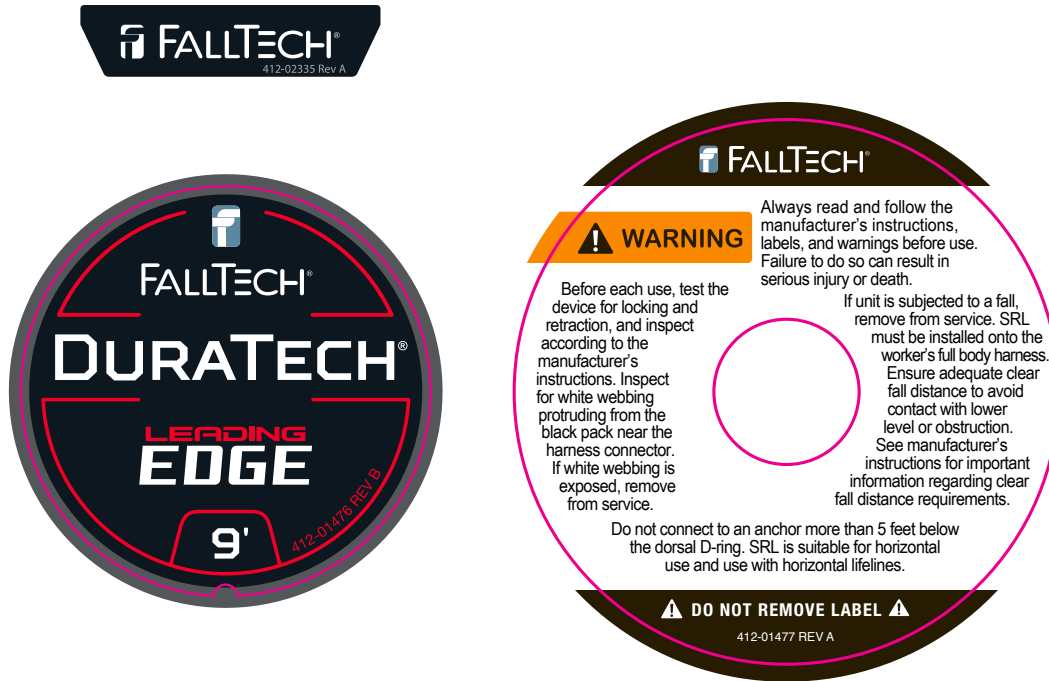

!INSPECTION! Inspect this product before each use. Semi-annual inspection by a competent person is required. Do not use if inspection reveals unsafe or defective condition. Remove the product from service immediately if it has been subjected to fall arrest forces. See the user instruction manual for complete inspection procedures.

412-00409 Rev A

1) USER MUST INSPECT BEFORE EACH USE.
 2) COMPETENT PERSON TO INSPECT AT LEAST ONCE EVERY (6) MONTHS.
 MARK OR PUNCH ON DATE GRID:
 A) INITIAL IN-SERVICE DATE
 B) DATE OF PASSED INSPECTION
 IF UNIT FAILS INSPECTION, REMOVE FROM SERVICE

Date:									
Initials:									

412-00410 Rev A

FallTech

800-719-4619
 Style#: 83909TP1
 ANSI Z359 14-2014
 Class B SRL-LE
 OSHA 1926.502
 Arrest Distance: 47"
 Avg Arrest Force: 900 lbs
 SERIAL NUMBER: 12345678

Date of Mfg: FEB 2019
 Max Free-fall: 5 ft
 Minimum Set-back Distance: 0'
 Clearance Range: 15' - 17'
 Capacity: 130-310lbs
 Material: Galvanized Steel Wire Rope

412-04036 Rev A

9.0 Definitions

The following are general definitions of fall protection terms as defined by ANSI Z359.0-2012.

Anchorage - A secure connecting point or a terminating component of a fall protection system or rescue system capable of safely supporting the impact forces applied by a fall protection system or anchorage subsystem.

Anchorage Connector - A component or subsystem that functions as an interface between the anchorage and a fall protection, work positioning, rope access or rescue system for the purpose of coupling the system to the anchorage.

Arrest Distance - The total vertical distance required to arrest a fall. The arrest distance includes the deceleration distance and activation distance.

Authorized Person - A person assigned by the employer to perform duties at a location where the person will be exposed to a fall hazard.

Available Clearance - The distance from a reference point, such as the working platform, to the nearest obstruction that an authorized person might contact during a fall which, if struck, could cause injury.

Capacity - The maximum weight that a component, system or subsystem is designed to hold.

Certification - The act of attesting in writing that the criteria established by these standards or some other designated standard have been met.

Certified Anchorage - An anchorage for fall arrest, positioning, restraint or rescue systems that a qualified person certifies to be capable of supporting the potential fall forces that could be encountered during a fall.

Clearance - The distance from a specified reference point, such as the working platform or anchorage of a fall arrest system, to the lower level that a worker might encounter during a fall.

Clearance Requirement - The distance below an authorized person that must remain clear of obstructions in order to ensure that the authorized person does not make contact with any objects that would cause injury in the event of a fall.

Competent Person - An individual designated by the employer to be responsible for the immediate supervision, implementation and monitoring of the employer's managed fall protection program who, through training and knowledge, is capable of identifying, evaluating and addressing existing and potential fall hazards, and who has the employer's authority to take prompt corrective action with regard to such hazards.

Component - An element or integral assembly of interconnected elements intended to perform one function in the system.

Connecting Subsystem - An assembly, including the necessary connectors, comprised of all components, subsystems, or both, between the anchorage or anchorage connector and the harness attachment point.

Connector - A component or element that is used to couple parts of the system together.

Deceleration Distance - The vertical distance between the user's fall arrest attachment at the onset of fall arrest forces during a fall, and after the fall arrest attachment comes to a complete stop.

Energy (Shock) Absorber - A component whose primary function is to dissipate energy and limit deceleration forces which the system imposes on the body during fall arrest.

Fall Arrest - The action or event of stopping a free fall or the instant where the downward free fall has been stopped.

Fall Hazard - Any location where a person is exposed to a potential free fall.

Free Fall - The act of falling before a fall protection system begins to apply forces to arrest the fall.

Free Fall Distance - The vertical distance traveled during a fall, measured from the onset of a fall from a walking working surface to the point at which the fall protection system begins to arrest the fall.

Harness, Full Body - A body support designed to contain the torso and distribute the fall arrest forces over at least the upper thighs, pelvis, chest and shoulders.

Horizontal Lifeline - A component of a horizontal lifeline subsystem, consisting of a flexible line with connectors or other coupling means at both ends for securing it horizontally between two anchorages or anchorage connectors.

Horizontal Lifeline Subsystem - An assembly, including the necessary connectors, comprised of a horizontal lifeline component and, optionally, of:
a) An energy absorbing component or, b) A lifeline tensioner component, or both. This subsystem is normally attached at each end to an anchorage or anchorage connector. The end anchorages have the same elevation.

Horizontal Lifeline – A component of a horizontal lifeline subsystem, consisting of a flexible line with connectors or other coupling means at both ends for securing it horizontally between two anchorages or anchorage connectors.

Horizontal Lifeline Subsystem – An assembly, including the necessary connectors, comprised of a horizontal lifeline component and, optionally, of:
a) An energy absorbing component or, b) A lifeline tensioner component, or both. This subsystem is normally attached at each end to an anchorage or anchorage connector. The end anchorages have the same elevation.

Lanyard - A component consisting of a flexible rope, wire rope or strap, which typically has a connector at each end for connecting to the body support and to a fall arrester, energy absorber, anchorage connector or anchorage.

Lanyard Connecting Subsystem - An assembly, including the necessary connectors, comprised of a lanyard only, or a lanyard and energy absorber.

Personal Fall Arrest System (PFAS) - An assembly of components and subsystems used to arrest a person in a free fall.

Positioning - The act of supporting the body with a positioning system for the purpose of working with hands free.

Positioning Lanyard - A lanyard used to transfer forces from a body support to an anchorage or anchorage connector in a positioning system.

Qualified Person - A person with a recognized degree or professional certificate and with extensive knowledge, training and experience in the fall protection and rescue field who is capable of designing, analyzing, evaluating and specifying fall protection and rescue systems.

Self-Retracting Device (SRD) - A device that contains a drum wound line that automatically locks at the onset of a fall to arrest the user, but that pays out from and automatically retracts onto the drum during normal movement of the person to whom the line is attached.

Snaphook - A connector comprised of a hook-shaped body with a normally closed gate or similar arrangement that may be opened to permit the hook to receive an object and, when released, automatically closes to retain the object.

Swing Fall - A pendulum-like motion that occurs during and/or after a vertical fall. A swing fall results when an authorized person begins a fall from a position that is located horizontally away from a fixed anchorage.

APPENDIX A



Table 1A: Specifications for 9' Cable DuraTech LE SRL					
Model #	Lifeline Material	Working Length and Weight	Materials and Specifications	Capacity and Standards	Images
83909SP1 83909SP3 83909SP5 83909SP6	3/16" Diameter 7X19 Galvanized Steel Cable	9 ft. 5.5 lbs.	Housing: Nylon Anchorage Carabiner: 5,000 lbs with 3,600 lbs Gate Strength	Single User Capacity: 130 to 310 lbs. ANSI Z359.14-2014 See Table 1B for Class A/B Designation	
83909TP1 83909TP3 83909TP5 83909TP6		9 ft. 9 lbs.	Leg-End Connector: 5,000 lbs with 3,600 lbs Gate Strength SRL-FBH Connector: Forged Aluminum 3,000 lbs Minimum		

Table 1B: 9' Cable DuraTech LE SRL Performance Attributes - Single Configuration								
Part #s and Conditions			Typical FallTech Performance			ANSI Performance Requirements		
Part #	Anchorage Condition	SRL Class	Arrest Distance	Average Arrest Force	Maximum Arrest Force	Maximum Arrest Distance	Average Arrest Force *Conditioned	Maximum Arrest Force
83909SP1 83909SP3 83909SP5 83909SP6	Overhead Non-Leading Edge	B	34.7"	813 lbs.	1,330 lbs.	54"	1,125 lbs.	1,800 lbs.
	Leading Edge Condition, Foot-Level with 5' Setback	N/A	74.4"	965 lbs.	1,354 lbs.	N/A	N/A	
	Leading Edge Condition, Foot-Level with 0' Setback	N/A	105"	876 lbs.	1,338 lbs.	N/A	N/A	

Table 1C: 9' Cable DuraTech LE SRL Performance Attributes - Twin Configuration								
Part #s and Conditions			Typical FallTech Performance			ANSI Performance Requirements		
Part #	Anchorage Condition	SRL Class	Arrest Distance	Average Arrest Force	Maximum Arrest Force	Maximum Arrest Distance	Average Arrest Force *Conditioned	Maximum Arrest Force
83909TP1 83909TP3 83909TP5 83909TP6	Overhead Non-Leading Edge	B	46.5"	924 lbs.	1,539 lbs.	54"	1,125 lbs.	1,800 lbs.
	Leading Edge Condition, Foot-Level with 5' Setback	N/A	92.8"	961 lbs.	1,294 lbs.	N/A	N/A	
	Leading Edge Condition, Foot-Level with 0' Setback	N/A	95.1"	898 lbs.	1,624 lbs.	N/A	N/A	