



SPEC SHEET

STM5810K MEGA Swivel 10k Steel Anchor

Design Specifications

The Swivel Anchor can be installed on steel structures with a variety of installation kits available to suit your application.

Material Specifications

Swivel Zinc Plated Steel

Weight 1.4 lbs

Performance Specifications

Tensile Strength 10,000-lbf / 44kN

Max User Weight 310-lbs / 140kg

Working Load 2,000-lbs / 908kg

Relevant Standards

ANSI Z359.1-2007

Z359.7-2011

OSHA

CFR 1926.502

CFR 1910.140

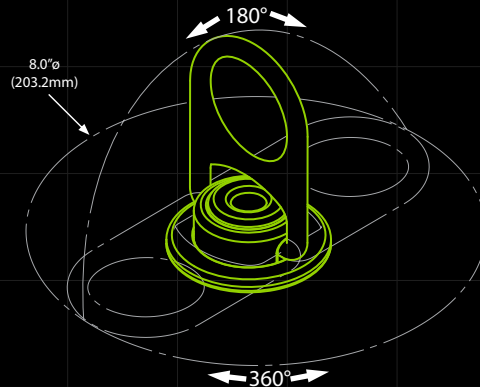
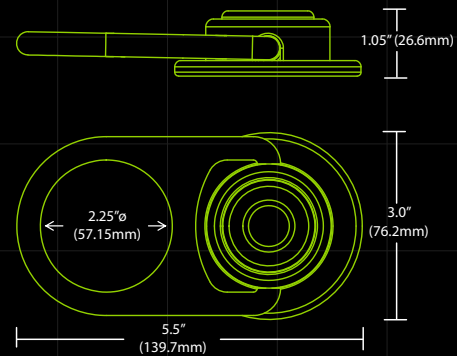

WARNINGS:

- Do not skip user instructions supplied with this product.
- Alteration or misuse of this product or failure to follow instructions may lead to serious injury or even death.

