



SAFEWAZE

2 PERSON TEMPORARY KERNMANTLE ROPE HORIZONTAL LIFELINE



Compliant with OSHA 1910, OSHA 1926 Subpart M
ANSI A10-14



These instructions must be provided to any person utilizing this equipment. The worker must read and understand the manufacturer's instructions for this, and all other components of the complete Fall Protection System. These instructions must be followed for the proper use, maintenance, and inspection of this equipment. These instructions must be kept and made available to worker's at all times. Any alteration, misuse, or use of this equipment outside the scope of the manufacturer's instructions, may result in serious injury or death.

This product is part of a complete fall protection system. User's must utilize, and connect to a SafeWaze Horizontal Lifeline (HLL) system with ANSI Z359 compliant restraint or Personal Fall Arrest Systems (PFAS). This product is not designed, nor should be used as a component for a Positioning, Suspension, or Rescue System. A PFAS is typically composed of a Full Body Harness, Anchorage, and a Connecting Device. Connecting Devices used with SafeWaze HLL's are Energy Absorbing Lanyards (EAL's) or a Self Retracting Lanyard (SRD). The connection point to the FBH for use of a SafeWaze HLL is the Dorsal D-ring.

A comprehensive Fall Protection Plan must be kept on file and available to all employees at all times. The employer and user's of this equipment must be properly trained in the installation, use, inspection, and maintenance of this equipment.

Consult your doctor if there is reason to doubt your fitness to safely absorb the shock from a fall arrest. Age and fitness seriously affect a worker's ability to withstand falls. Pregnant women or minors must not use this equipment. Failure to heed this warning may result in serious injury or death.

The maximum weight capacity of this equipment is 310 lbs. per user, up to a maximum of two users (including tools and equipment) as specified by ANSI. The weight capacity of this equipment for a single user is 420 lbs. (including tools and equipment).

User's of this equipment must read and understand this manual in it's entirety prior to use.

Contact SafeWaze if you have questions, regarding compatibility of this equipment, that are not covered in this manual. Do not alter or misuse this equipment. Some subsystem components could affect the performance and the operation of this equipment. Do not anchor this product to moving machinery, or hazards that have chemical, electrical or gaseous characteristics. Failure to comply with this warning could result in serious injury or death.

Table of Contents

1	INTRODUCTION & SCOPE OF USE.....	3
2	APPLICABLE SAFETY STANDARDS.....	3
3	WORKER CLASSIFICATIONS.....	3
4	PRODUCT SPECIFIC APPLICATIONS.....	4
5	LIMITATIONS.....	4
6	COMPATIBILITY OF CONNECTIONS	5
7	MAKING CONNECTIONS.....	6-7
8	COMPONENTS AND SPECIFICATIONS.....	8
9	INSTALLATION AND USE.....	9-13
10	FALL CLEARANCE CHARTS.....	14-16
11	INSPECTION AND MAINTENANCE	17
12	INSPECTION LOG	18
13	LABELS	19

1.0 Introduction & Scope of Use

Thank you for purchasing a SafeWaze Kernmantle Rope Horizontal Lifeline. This manual must be read and understood in its entirety, and used as part of an employee training program as required by OSHA or any applicable state agency.

This manual and any other instructional material must be available to the user of the equipment. The user must understand how to safely and effectively use a Horizontal Lifeline, and all fall protection equipment used in conjunction with such.

The SafeWaze Kernmantle Rope Horizontal Lifeline has been designed for your safety.

These Horizontal Lifeline systems are designed to offer users a flexible anchorage between two structures. The lines can also be used to provide a temporary barrier system.

2.0 Applicable Safety Standards

ANSI STANDARDS

ANSI	Z359.0	Definitions and Nomenclature Used for Fall Protection and Fall Arrest
ANSI	Z359.1	Safety Requirements for Personal Fall Arrest Systems, Subsystems, and Components
ANSI	Z359.2	Minimum Requirements for a Comprehensive Managed Fall Protection Program
ANSI	A10-14	Safety Requirements for Safety Belts, Harnesses, Lanyards, and Lifelines for Construction and Demolition Use

OSHA REGULATIONS

OSHA	1910.66	Personal Fall Arrest Systems
OSHA	1926.502	Fall Protection Systems Criteria and Practices

3.0 Worker Classifications

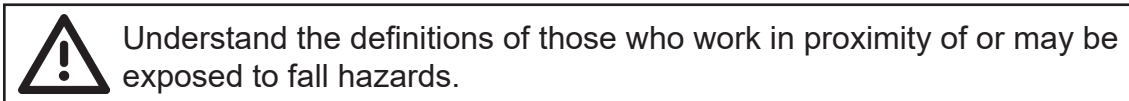

Qualified Person: A person with an accredited degree or certification, and with extensive experience or sufficient professional standing, who is considered proficient in planning and reviewing the conformity of fall protection and rescue systems.

Competent Person: A highly trained and experienced person who is **assigned by the employer** to be responsible for all elements of a fall safety program, including, but not limited to, its regulation, management, and application. A person who is proficient in identifying existing and predictable hazards, and who has the authority to stop work in order to eliminate hazards.

Authorized Person: A person who is assigned by their employer to work around or be subject to potential or existing fall hazards.

It is the responsibility of a Qualified or Competent person to supervise the job site and ensure safety regulations are complied with.

4.0 Product Specific Applications

Personal Fall Arrest: SafeWaze Kernmantle Rope Horizontal Lifelines can be used as part of a complete Personal Fall Arrest System (PFAS) for a maximum of 2 users. The structure utilized for attachment must be capable of withstanding a load of 5,000 lbs in all directions permitted by the system. The maximum allowable free fall is 6 ft.

5.0 Limitations

Fall Clearance: There must be sufficient clearance below the anchorage connector to arrest a fall before the user strikes the next lower level, or an obstruction. When calculating fall clearance, account for a MINIMUM 2' safety factor, deceleration distance, user height, length of Lanyard/SRD, and all other applicable factors (See Figure 1).

FIGURE 1 - FALL CLEARANCE CALCULATION DIAGRAM

For all applications: Worker Weight Max Capacity for a Single User (including all clothing, tools, and equipment) is 420 lbs.
Capacity range for 2 Users is (130-310 lbs) for each User (including all clothing, tools, and equipment)

Fall Clearance Diagram

***Diagram shown is an EXAMPLE how to calculate clear fall requirements.

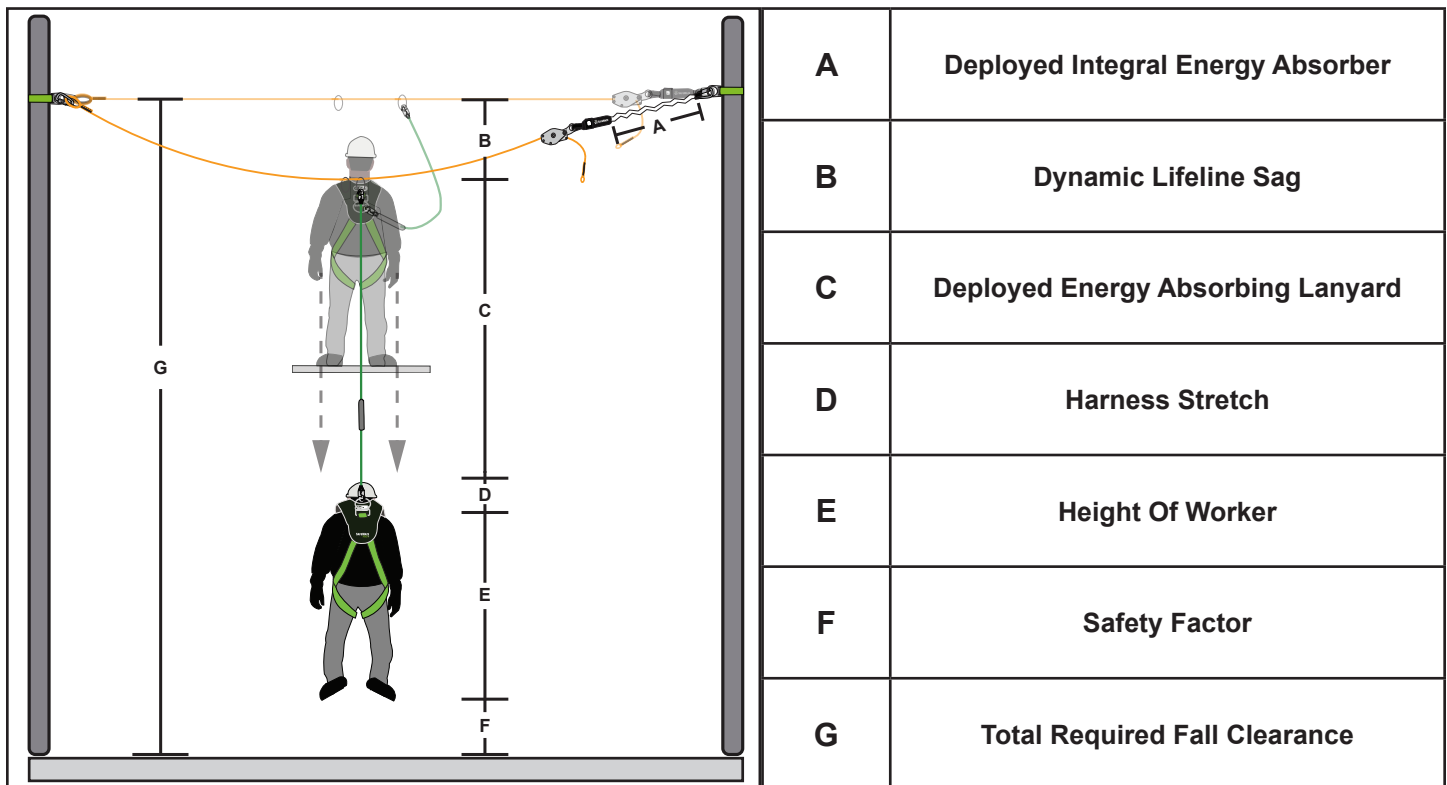

Swing Falls: Prior to installation or use, make considerations for eliminating or minimizing all swing fall hazards. Swing falls occur when the anchor is not directly above the location where a fall occurs. Always work as close to in line with the anchor point as possible. Swing falls significantly increase the likelihood of serious injury or death in the event of a fall (See Figure 2).

FIGURE 2 - SWING FALL

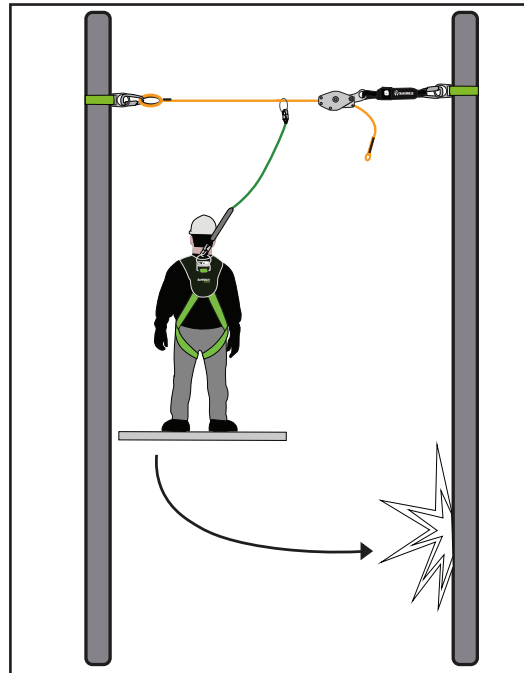

6.0 Compatibility Of Connections

Connectors are compatible with connecting elements when they have been designed to work together in such a way that their sizes and shapes do not cause their gate mechanisms to inadvertently open regardless of how they become oriented. Connectors (hooks, carabiners, and D-rings) must be capable of supporting at least 5,000 lbs. (22.2 kN). Connectors must be compatible with the anchorage or other system components (See Figure 4). Do not use equipment that is not compatible. Non-compatible connectors may unintentionally disengage (See Figure 3). Connectors must be compatible in size, shape, and strength. Self-locking snap hooks and carabiners are required by ANSI Z359 and OSHA guidelines. Contact SafeWaze if you have any questions about compatibility.



NOTE: SOME SPECIALITY CONNECTORS HAVE ADDITIONAL REQUIREMENTS. CONTACT SAFEWAZE WITH QUESTIONS.

FIGURE 3 - UNINTENTIONAL DISENGAGEMENT

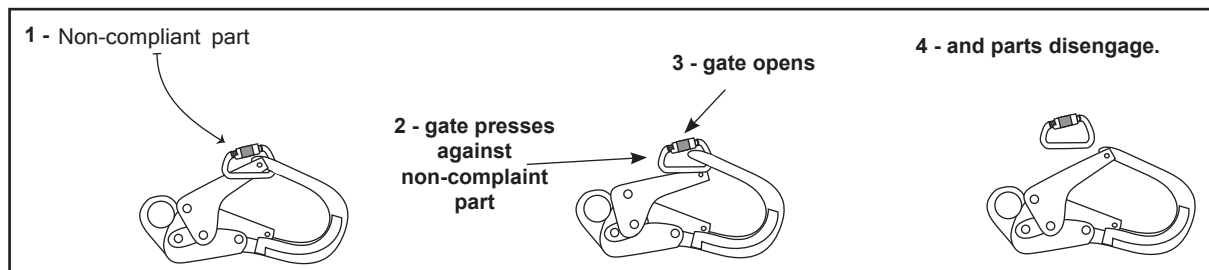

Using a connector that is undersized or irregular in shape (1) to connect a snap hook or carabiner could allow the connector to force open the gate of the snap hook or carabiner. When force is applied, the gate of the hook or carabiner presses against the non-compliant part (2) and forces open the gate (3). This allows the snap hook or carabiner to disengage (4) from the connection point.

7.0 Making Connections

Snap hooks and carabiners used with this equipment must be double locking and/ or twist lock. Ensure all connections are compatible in size, shape and strength. Do not use equipment that is not compatible. Ensure all connectors are fully closed and locked.

SafeWaze connectors (snap hooks and carabiners) are designed to be used only as specified in each product's user's instructions. See figure 4 for examples of inappropriate connections. Do not connect snap hooks and carabiners:

- To a D-ring to which another connector is attached.
- In a manner that would result in a load on the gate (with the exception of tie back hooks).
- In a false engagement, where features that protrude from the snap hook or carabiner catch on the anchor, and without visual confirmation seems to be fully engaged to the anchor point.
- To each other.
- By wrapping the web lifeline around an anchor and securing to lifeline except as allowed for Tie Back models.
- To any object which is shaped or sized in a way that the snap hook or carabiner will not close and lock, or that roll-out could occur.
- In a manner that does not allow the connector to align properly while under load.
- NOTE: Large snap hooks must not be connected to objects which will result in a load on the gate if the hook twists or rotates, unless the snap hook complies with ANSI Z359.1-2007 or ANSI Z359.12 and is equipped with a 3,600 lb (16 kN) gate. Check the marking on your snap hook to verify its compatibility.



NOTE: Large throat snap hooks must not be connected to standard size D-rings or similar objects which will result in a load on the gate if the hook or D-ring twists or rotates, unless the snap hook complies with ANSI Z359.1-2007 or ANSI Z359.12 and is equipped with a 3,600 lb (16 kN) gate. Check the marking on your snap hook to verify that it is appropriate for your application.

FIGURE 4 - INAPPROPRIATE CONNECTIONS

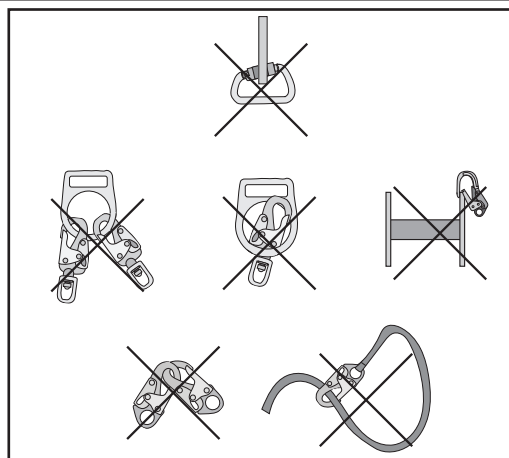

7.1 Connections

Number of Users:

Maximum two users at one time with a capacity up to 310 lbs. per worker including tools and equipment.

Maximum one user at one time with a capacity up to 420 lbs. per worker including tools and equipment.

Full Body Harnesses

Only Full Body Harnesses may be used with a SafeWaze Kernmantle Rope Horizontal Lifeline.

Use of Shock Absorbing Lanyards

Fall Clearance Requirements when utilizing a 6' Shock Absorbing Lanyard with the HLL system are indicated in the fall clearance table in Section 10, page 14 of this manual. The fall clearance distances indicated are the total required from the properly installed HLL system to the next lower level or obstruction. The user should ensure that the distance between the installed lifeline and the next lower level is at least equal to, or greater than the values given in Section 10, page 14 of this manual prior to use of the HLL system. Failure to calculate proper fall clearances prior to use of the system could result in serious injury or death.



Note: Never use combinations of components or subsystems that may affect, or interfere with the safe function of each other.

Use of Self-Retracting Devices

Fall Clearance Requirements when utilizing an SRD with the HLL system in an overhead installation are indicated in the fall clearance table in Section 10.1, page 15 of this manual. When using Personal SRD's with the HLL system, where the installation could possibly be below dorsal D-ring Height, refer to the fall clearance table in Section 10.2, page 16 of this manual. The user must ensure that the Personal SRD being utilized is not connected to the HLL at a distance below the dorsal D-ring, which exceeds the maximum allowed as specified by the SRD manufacturer. When calculating fall clearance distances, the user must add the total deflection of the HLL system during a fall event, to the total deceleration distance of the SRD being used. The combination of the system deflection, and the deceleration distance of the SRD, when added to the Harness Stretch of the full body harness, worker's height, and Safety Factor equals the minimum required fall clearance. Failure to calculate proper fall clearances prior to use of the system could result in serious injury or death.

8.0 Components and Specifications

FIGURE 5 - HLL KIT PART NUMBERS AND CONFIGURATIONS

Configuration 1		Configuration 2		Configuration 3	
					
Part Number	Length in Feet	Part Number	Length in Feet	Part Number	Length in Feet
019-8000	30 ft.	019-8004	30 ft.	019-8008	30 ft.
019-8001	60 ft.	019-8005	60 ft.	019-8009	60 ft.
019-8002	80 ft.	019-8006	80 ft.	019-8010	80 ft.
019-8003	100 ft	019-8007	100 ft	019-8011	100 ft

SafeWaze Kernmantle Rope Horizontal Lifelines are offered in three different configurations. Four lengths are offered in each configuration. The tables above indicate the part numbers and system lengths offered in each configuration. Configuration 1 is a complete Kernmantle Rope Horizontal Lifeline system but does not include anchorage connectors. Configuration 2 is a complete HLL system, and includes two SafeWaze FS810-6 Cross Arm Straps for anchorage connection (See Figure 6). Configuration 3 is a complete HLL system, and includes two SafeWaze 018-4000 Chain Anchors for anchorage connection (See Figure 7).

9.0 Installation and Use

Before Each Use

Users of personal fall arrest systems must have a rescue plan in place, if the user cannot rescue themselves, as well as the means to carry out the rescue.

The user must read and understand these User Instructions, as well as the User Instructions for every component/subsystem of the personal fall arrest system.

The entire Safewaze Kernmantle Rope Horizontal Lifeline system, and its subsystems, must be inspected prior to each use for wear, damage, and other deterioration. All snaphooks and carabiners must be able to self-close and lock. Check the operation of self retracting lanyards by pulling smoothly on the lifeline, then pull sharply on the lifeline to engage the locking mechanism. All webbing and rope must be inspected for tears, cuts, fraying, abrasion, unsplicing, discoloration, or other signs of wear and damage. Sewn terminations should be secure, complete, and not visibly damaged. All rope splices should be secure. System must be properly tensioned. No load indicators shall be deployed. Damaged and other deteriorated and defective components must be immediately removed from service, in accordance with the requirements of OSHA 29 CFR 1910.66 and 1926.502.

FIGURE 6 - CROSS ARM STRAP INSTALLATION EXAMPLE

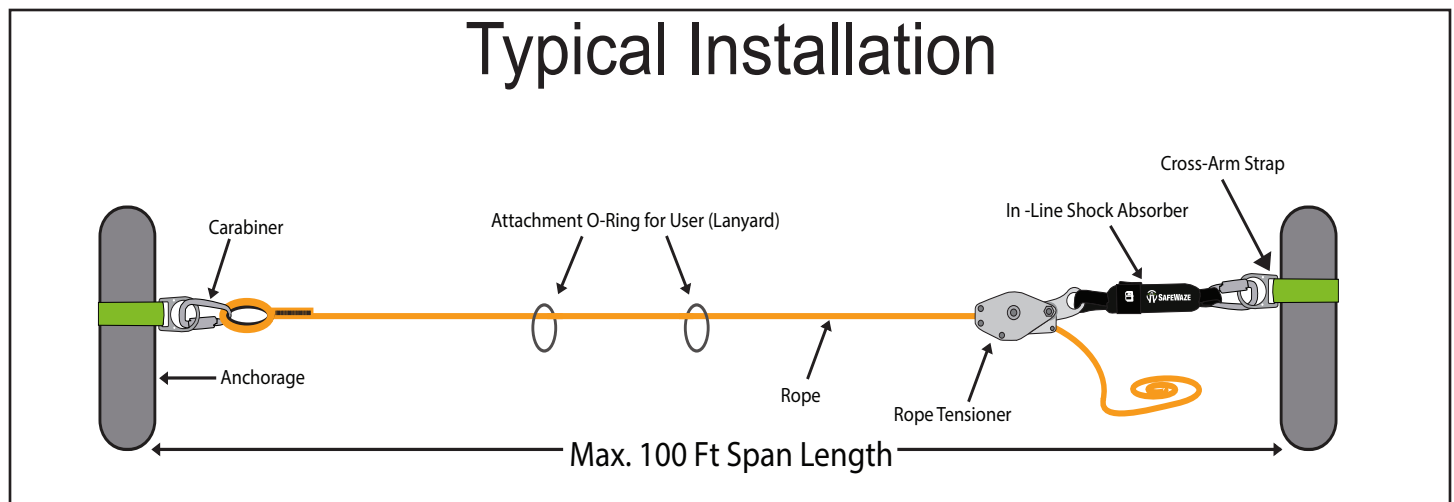

Cross Arm Strap System Installation

Step 1. Install Anchorage Connector

Wrap the Cross Arm Strap around the anchorage and pass the small D-ring end through the large D-ring end. Wrap as many times as necessary to achieve desired length, ensuring strap is wrapped at least **twice** around the end anchorage. A minimum of two wraps around the end anchorage helps prevent sliding of the anchor straps during use. Only connect to the small D-ring of the Cross Arm Strap.

Other approved anchorage connectors may be used in place of the supplied Cross Arm Strap. See anchorage connector user instructions for proper installation.

Step 2. Connect Thimble End of Rope

Connect the Thimble End of the rope lifeline to the small D-ring of the Cross Arm Strap using the supplied carabiner.

Step 3. Connect In-Line Shock Absorber

Attach the In-Line Shock Absorber (Shock Absorber is pre-attached to Rope Tensioner) to the remaining end anchorage connector via the other supplied carabiner. Be sure to connect to the small D-ring of the Cross Arm Strap

Step 4. Tension the System

Place the locking lever in the closed position so that it is engaged (See Figure 9A). Remove the slack from the system by pulling the pre-installed rope through the tensioner by hand until the slack has been removed from the system. Use a 1-1/4" wrench or metal bar (See Figure 9D) to turn ratchet in the direction of the arrow until wheel slips or no longer rotates. Final tension on the system should be approximately 200-250 lbs. Do not over tension the system or alter the tensioner to achieve greater tension (See Figure 9E).

Step 5. Connect to System

Once properly tensioned, connect a PFAS system only to the connection O-rings preinstalled on the lifeline.

FIGURE 7 - CHAIN ANCHOR INSTALLATION EXAMPLE

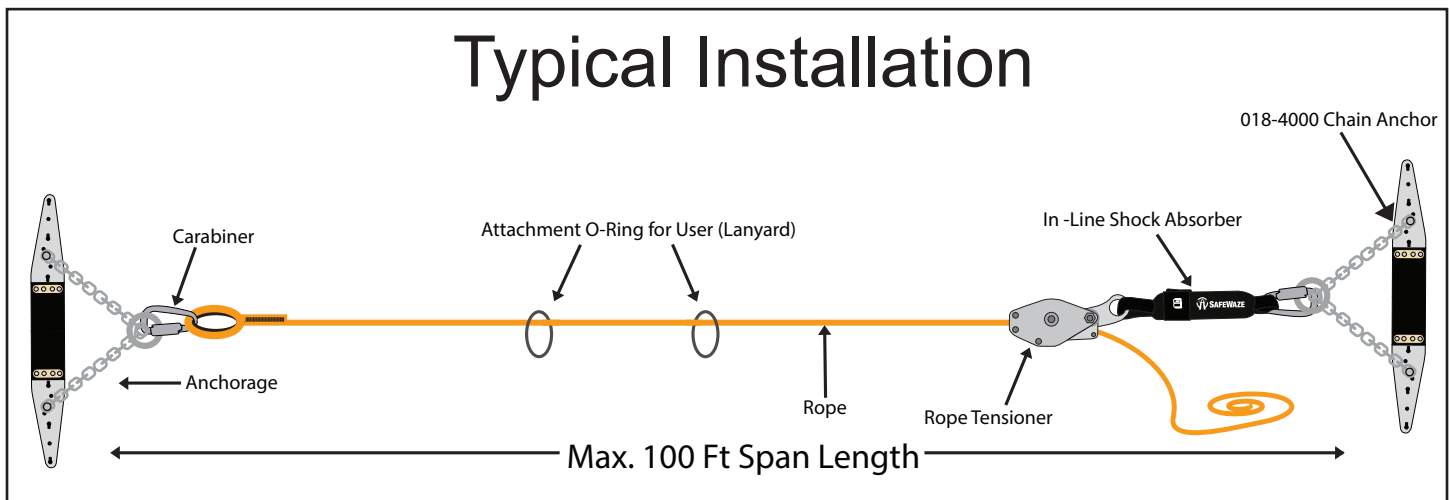
**Chain Anchor System Installation****Step 1. Install Anchorage Connector**

Under guidance of a Competent or Qualified Person, a suitable anchor point must be chosen that meets the strength requirement, minimizes free fall, and reduces swing fall hazards. Do not work above the anchorage point. The 018-4000 Chain Anchor can be mounted at the peak of a roof structure with one mounting plate on each side of the peak, or mounted flat on the roof perpendicular to the peak. In either instance, the Chain Anchor must be mounted to the roof structure through the sheathing and into a joist via the supplied (6) 5/16" x 3" lag bolts, or with (12) customer supplied 16D Nails. All fasteners must be fully embedded into sheathing and joist (See Figure 8). The 018-4000 Chain Anchor can be removed and re-used unless the Chain Anchor is

damaged or has experienced Fall Arrest Forces. If either of these conditions exist, the Chain Anchor must IMMEDIATELY be removed from service and destroyed.

Other approved anchorage connectors, which meet the 5,000 lbs strength requirement, may be used in place of the supplied 018-4000 Chain Anchors. See anchorage connector user instructions for proper installation.

Step 2. Connect Thimble End of Rope

Connect the Thimble End of the rope lifeline to the small O-ring of the Chain Anchor using the supplied carabiner.

Step 3. Connect In-Line Shock Absorber

Attach the In-Line Shock Absorber (Shock Absorber is pre-attached to Rope Tensioner) to the remaining end anchorage connector via the other supplied carabiner. Be sure to connect to the small D-ring of the Cross Arm Strap

Step 4. Tension the System

Place the locking lever in the closed position so that it is engaged (See Figure 9A). Remove the slack from the system by pulling the pre-installed rope through the tensioner by hand until the slack has been removed from the system. Use a 1-1/4" wrench or metal bar (See Figure 9D) to turn ratchet in the direction of the arrow until wheel slips or no longer rotates. Final tension on the system should be approximately 200-250 lbs. Do not over tension the system or alter the tensioner to achieve greater tension (See Figure 9E).

Step 5. Connect to System

Once properly tensioned, connect a PFAS system only to the connection O-rings preinstalled on the lifeline.

FIGURE 8 - CHAIN ANCHOR INSTALLATION

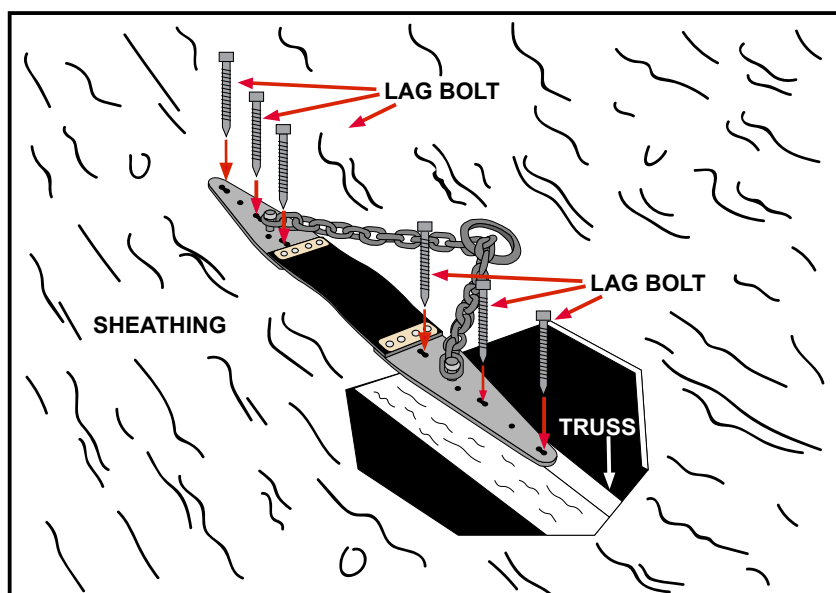
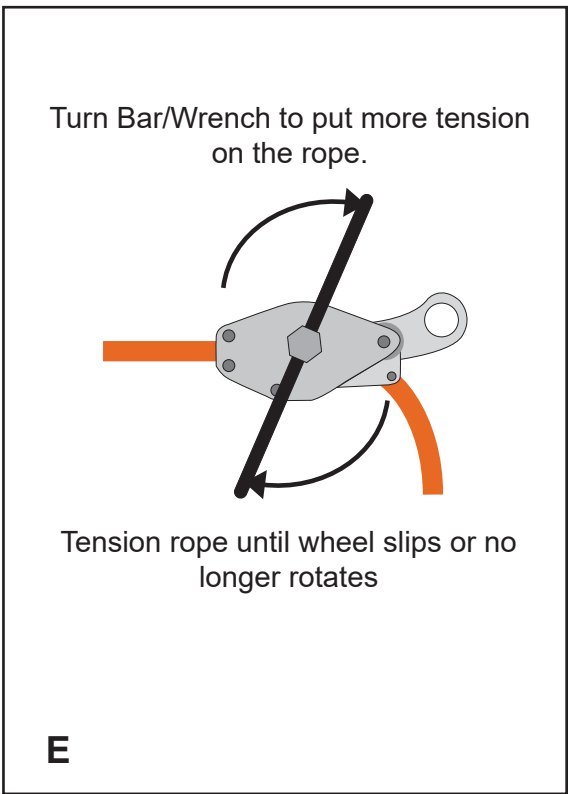
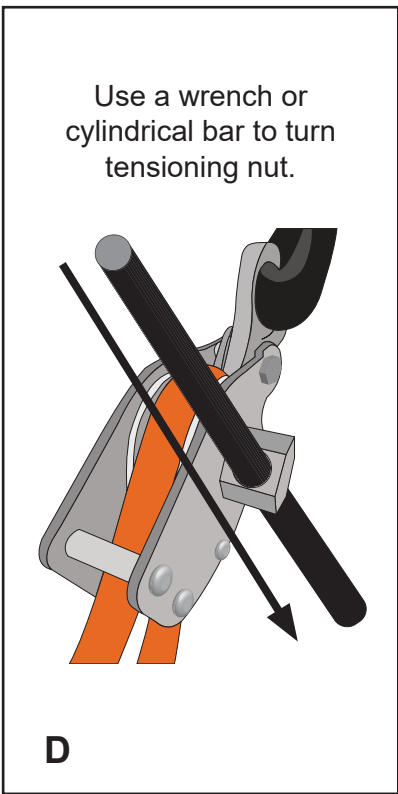
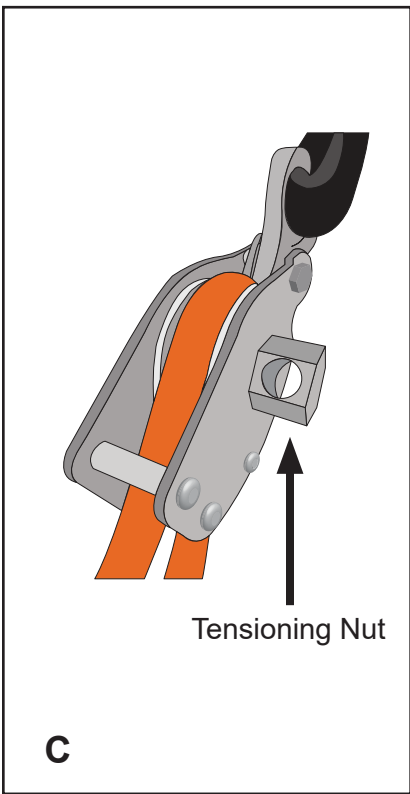
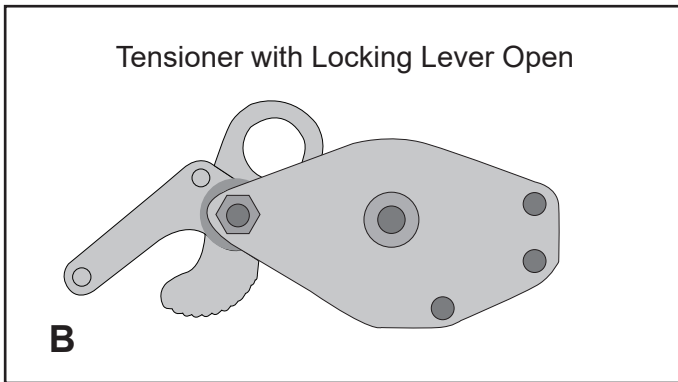
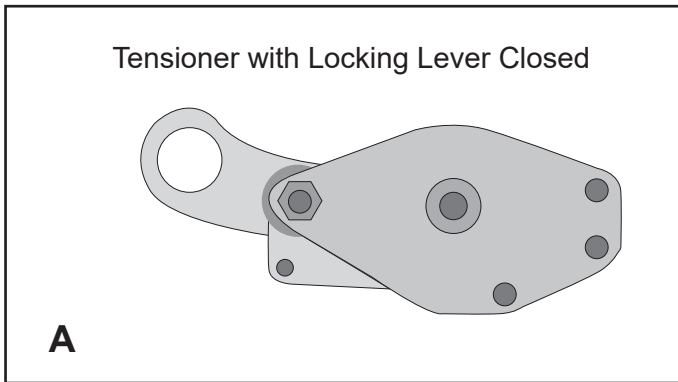
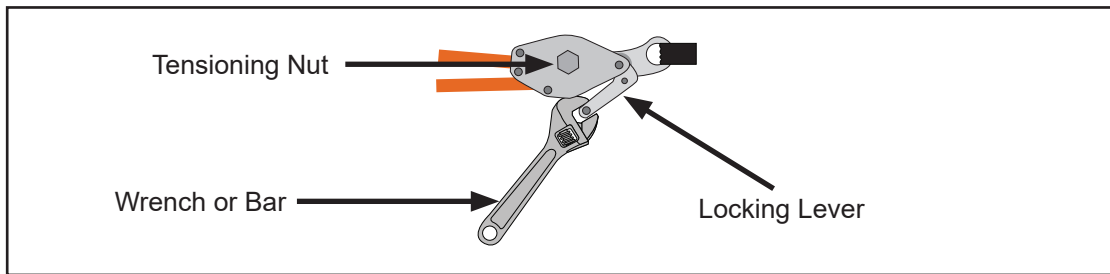

FIGURE 9 - ROPE TENSIONER OPERATION



Specifications:
-Plated Steel
-Designed to be used with the SafeWaze Kernmantle Rope Horizontal Lifeline System
-Weight: 3.6 lbs
-Minimum Break Strength of 16mm Kernmantle Rope 9,807 lbs.
Meets all ANSI and OSHA specifications

FIGURE 10 - RELEASING LIFELINE TENSION



Once work operations are complete, work requires movement of HLL system to another location, or the system needs to be uninstalled, the lifeline tension will need to be released. To release the tension:

Step 1. Lift the locking lever to a position where a bar or wrench can be inserted between the locking lever and the body of the tensioner.

Step 2. Using the bar or wrench, pry the locking lever open to release the tension on the lifeline.

Step 3. Loosen the tensioning nut with the bar or wrench by turning the tensioning nut counter clockwise until loose.

Step 4. The rope can be pulled through the tensioner by hand if necessary, by holding the locking lever in the disengaged position and pulling the rope through the tensioner.

FIGURE 11 - COMPONENTS

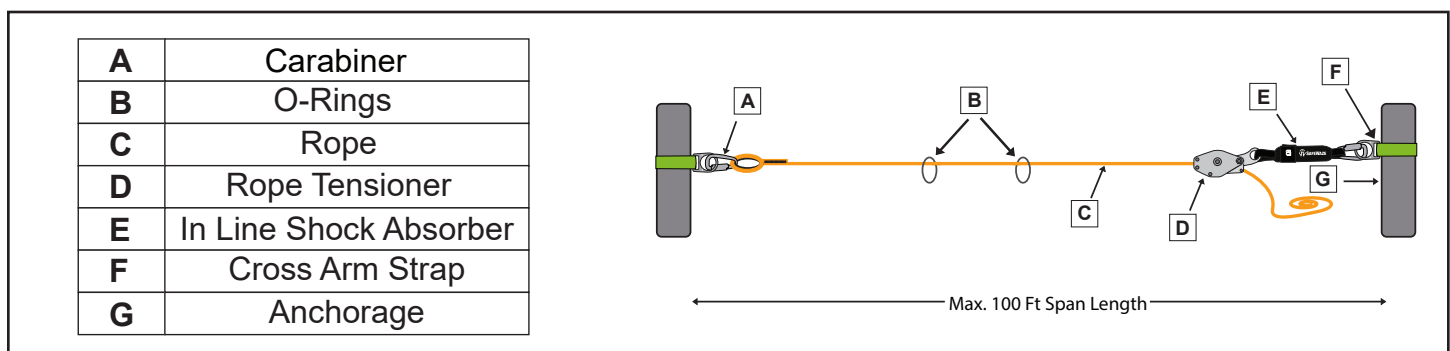

The SafeWaze Kernmantle Horizontal Lifeline is designed as a temporary reusable anchorage subsystem for attachment of up to two Personal Fall Arrest systems. The Kernmantle Horizontal Lifeline subsystem is comprised of 32 strand, 12,000 lbs. tensile strength 11/16" (17mm) diameter nylon Kernmantle rope with a stitched thimble connection eye on one end and a rope tensioning device on the other. The system also contains an in-line energy absorber and two self-closing, self-locking, ANSI Z359.12 compliant end attachment carabiners. One carabiner is attached to the thimble eye, and one is attached to the rope tensioning device. The rope tensioning device is a plated steel tensioner through which the kernmantle rope is threaded and then stitch terminated to prevent removal of the rope from the tensioner.

10.0 Fall Clearance Charts

**6 ft. Energy Absorbing Lanyard Fall Clearance Chart
(1 User)
420 lbs. Max Capacity**

		Freefall Distance in Feet						
		0	1	2	3	4	5	6
Span Length in Feet (m)	0-30 (0-9.14)	17 (5.18)	18.0 (5.48)	19.0 (5.79)	20.0 (6.09)	21.0 (6.40)	22.0 (6.70)	23.0 (7.01)
	31-40 (9.44-12.20)	18.5 (5.63)	19.5 (5.94)	20.5 (6.24)	21.5 (6.55)	22.5 (6.85)	23.5 (7.16)	24.5 (7.46)
	41-50 (12.50-15.24)	20.0 (6.09)	21.0 (6.40)	22.0 (6.70)	23.0 (7.01)	24.0 (7.31)	25.0 (7.62)	26 (7.92)
	51-60 (15.54-18.28)	21.5 (6.55)	22.5 (6.85)	23.5 (7.16)	24.5 (7.46)	25.5 (7.77)	26.5 (8.07)	27.5 (8.38)
	61-70 (18.60-21.33)	24.0 (7.31)	25.0 (7.62)	26.0 (7.92)	27.0 (8.22)	28.0 (8.53)	29.0 (8.83)	30.0 (9.14)
	71-80 (21.64-24.38)	25.5 (7.77)	26.5 (8.07)	27.5 (8.38)	28.5 (8.68)	29.5 (8.99)	30.5 (9.29)	31.5 (9.60)
	81-90 (24.68-27.43)	27.0 (8.22)	28.0 (8.53)	29.0 (8.83)	30.0 (9.14)	31.0 (9.44)	32.0 (9.75)	33.0 (10.05)
	91-100 (27.73-30.48)	29.0 (8.83)	30.0 (9.14)	31.0 (9.44)	32.0 (9.75)	33.0 (10.05)	34.0 (10.36)	35.0 (10.66)

**6 ft. Energy Absorbing Lanyard Fall Clearance Chart
(2 Users)
310 lbs. Max Capacity per User**

		Freefall Distance in Feet						
		0	1	2	3	4	5	6
Span Length in Feet (m)	0-30 (0-9.14)	20.0 (6.09)	21.0 (6.40)	22.0 (6.70)	23.0 (7.01)	24.0 (7.31)	25.0 (7.62)	26 (7.92)
	31-40 (9.44-12.20)	21.5 (6.55)	22.5 (6.85)	23.5 (7.16)	24.5 (7.46)	25.5 (7.77)	26.5 (8.07)	27.5 (8.38)
	41-50 (12.50-15.24)	24.0 (7.31)	25.0 (7.62)	26.0 (7.92)	27.0 (8.22)	28.0 (8.53)	29.0 (8.83)	30.0 (9.14)
	51-60 (15.54-18.28)	25.5 (7.77)	26.5 (8.07)	27.5 (8.38)	28.5 (8.68)	29.5 (8.99)	30.5 (9.29)	31.5 (9.60)
	61-70 (18.60-21.33)	28.0 (8.53)	29.0 (8.83)	30.0 (9.14)	31.0 (9.44)	32.0 (9.75)	33.0 (10.05)	34.0 (10.36)
	71-80 (21.64-24.38)	30.5 (9.29)	31.5 (9.60)	32.5 (9.90)	33.5 (10.21)	34.5 (10.51)	35.5 (10.82)	36.5 (11.12)
	81-90 (24.68-27.43)	32.5 (9.90)	33.5 (10.21)	34.5 (10.51)	35.5 (10.82)	36.5 (11.12)	37.5 (11.43)	38.5 (11.73)
	91-100 (27.73-30.48)	34.5 (10.51)	35.5 (10.82)	36.5 (11.12)	37.5 (11.43)	38.5 (11.73)	39.5 (12.03)	40.5 (12.34)

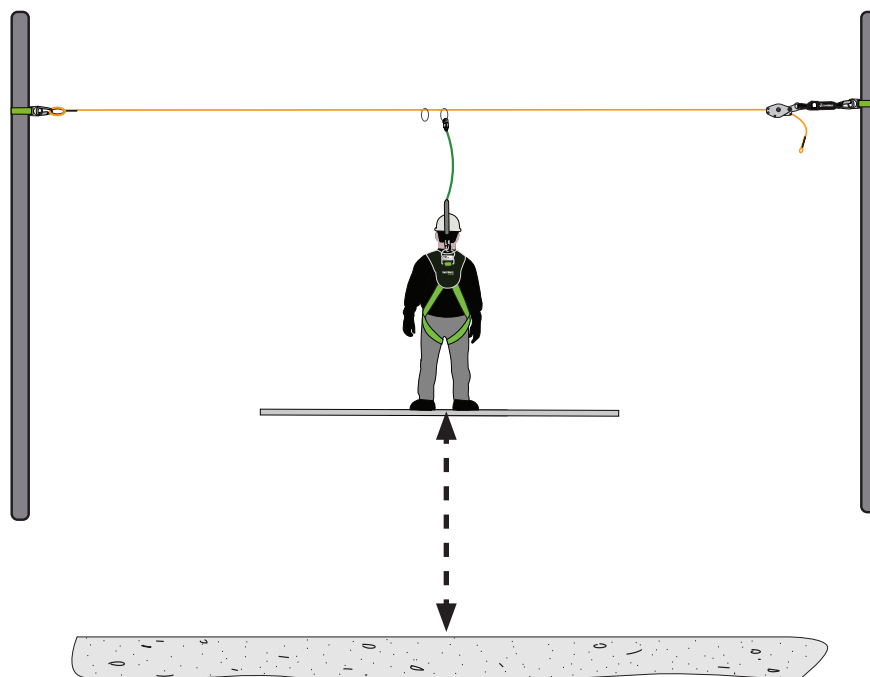

10.1 Fall Clearance Charts

**Overhead SRD Usage
Fall Clearance Chart
(1 To 2 Users)**

**Fall Clearance Chart
Class A SRD**

**Fall Clearance Chart
Class B SRD**

**SafeWaze Required Fall Clearance for Up to 2 Users
Maximum Span 100 ft.**

Span Length In Feet (m)	Fall Clearance with SafeWaze SRD in Feet (m)	Fall Clearance with SafeWaze SRD in Feet (m)
	ONE USER	TWO USERS
0-30 (0-9.14)	14.0 (4.26)	17.0 (5.18)
31-40 (9.44-12.20)	15.5 (4.72)	18.0 (4.48)
41-50 (12.50-15.24)	16.5 (5.02)	19.0 (5.79)
51-60 (15.54-18.28)	18.5 (5.63)	20.5 (6.24)
61-70 (18.60-21.33)	19.5 (5.94)	22.0 (6.70)
71-80 (21.64-24.38)	21.0 (6.40)	23.0 (7.01)
81-90 (24.68-27.43)	22.0 (6.70)	24.0 (7.31)
91-100 (27.73-30.48)	23.5 (7.16)	25.5 (7.77)

**SafeWaze Required Fall Clearance for Up to 2 Users
Maximum Span 100 ft.**

Span Length In Feet (m)	Fall Clearance with SafeWaze SRD in Feet (m)	Fall Clearance with SafeWaze SRD in Feet (m)
	ONE USER	TWO USERS
0-30 (0-9.14)	16.5 (5.02)	19.5 (5.94)
31-40 (9.44-12.20)	18.0 (5.48)	20.5 (6.24)
41-50 (12.50-15.24)	19.0 (5.79)	21.5 (6.55)
51-60 (15.54-18.28)	21.0 (6.40)	23.0 (7.01)
61-70 (18.60-21.33)	22.0 (6.70)	24.5 (7.46)
71-80 (21.64-24.38)	23.5 (7.16)	25.5 (7.77)
81-90 (24.68-27.43)	24.5 (7.46)	26.5 (8.07)
91-100 (27.73-30.48)	26.0 (7.92)	28.0 (8.53)

****THESE CLEARANCE CHARTS REQUIRE THAT THE SRD IS OVER THE HEAD OF THE WORKER WHEN ATTACHED TO THE HORIZONTAL LIFELINE**

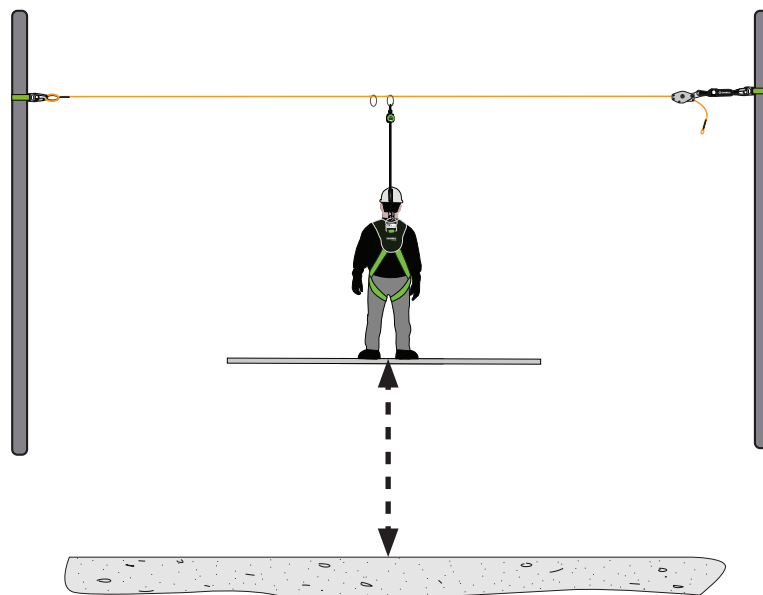

10.2 Fall Clearance Charts

**Personal SRD Usage
At or Below Dorsal D-ring Height
Fall Clearance Chart
(2 Users)**

		Freefall Distance in Feet					
		0	1	2	3	4	5
Span Length in Feet (m)	0-30 (0-9.14)	17 (5.18)	18.0 (5.48)	19.0 (5.79)	20.0 (6.09)	21.0 (6.40)	22.0 (6.70)
	31-40 (9.44-12.20)	18.5 (5.63)	19.5 (5.94)	20.5 (6.24)	21.5 (6.55)	22.5 (6.85)	23.5 (7.16)
	41-50 (12.50-15.24)	20.0 (6.09)	21.0 (6.40)	22.0 (6.70)	23.0 (7.01)	24.0 (7.31)	25.0 (7.62)
	51-60 (15.54-18.28)	21.5 (6.55)	22.5 (6.85)	23.5 (7.16)	24.5 (7.46)	25.5 (7.77)	26.5 (8.07)
	61-70 (18.60-21.33)	24.0 (7.31)	25.0 (7.62)	26.0 (7.92)	27.0 (8.22)	28.0 (8.53)	29.0 (8.83)
	71-80 (21.64-24.38)	25.5 (7.77)	26.5 (8.07)	27.5 (8.38)	28.5 (8.68)	29.5 (8.99)	30.5 (9.29)
	81-90 (24.68-27.43)	27.0 (8.22)	28.0 (8.53)	29.0 (8.83)	30.0 (9.14)	31.0 (9.44)	32.0 (9.75)
	91-100 (27.73-30.48)	29.0 (8.83)	30.0 (9.14)	31.0 (9.44)	32.0 (9.75)	33.0 (10.05)	34.0 (10.36)

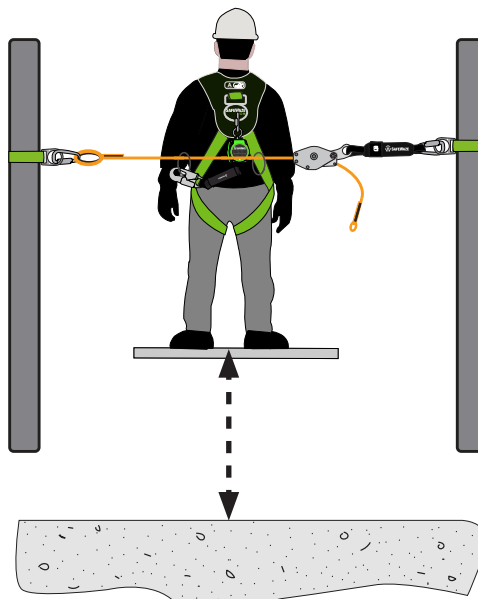

11.0 Inspection and Maintenance

Inspection

Inspect the device for corrosion and/or damage.

Check the Housing Plates for signs of distortion.

Inspect both the webbing of Cross Arm Straps (if being used) and Rope for cuts, abrasions and contamination.

Check carabiners for proper operation, signs of corrosion, distortion or damage.

Frequency

All components of the SafeWaze Kernmantle Rope Horizontal Lifeline must be inspected prior to each use, and annually by a “competent person” (other than the user), as defined by OSHA.

Criteria

If inspection reveals any defect, inadequate maintenance, or unsafe condition, remove from service until a “qualified person” as defined by OSHA 1926.32(m) can determine the need for authorized repair or disposal.

Maintenance

Any SafeWaze Kernmantle Rope Horizontal Lifeline components requiring maintenance must be tagged “unusable” and removed from service.

Cleaning maintenance may be performed by the user.

Repairs to the product may only be made by the manufacturer or entities authorized in writing by the manufacturer.

**THIS SYSTEM MUST BE INSPECTED BY A TRAINED COMPETENT INDIVIDUAL OR
SAFEWAZE!**

NEVER ATTEMPT TO SERVICE THIS UNIT OR TAMPER WITH ITS FUNCTION IN ANY WAY!

Storage

When not installed, the SafeWaze Horizontal Lifeline should be stored in a cool, dry place out of direct sunlight. Do not store in areas where damage from environmental factors such as heat, light, excessive moisture, oil, chemicals and their vapors, or other degrading elements may be present. Do not store damaged equipment or equipment in need of maintenance in the same area as product approved for use. Equipment that has been stored for an extended period must be inspected as described in these User Instructions prior to use.

13.0 Labels

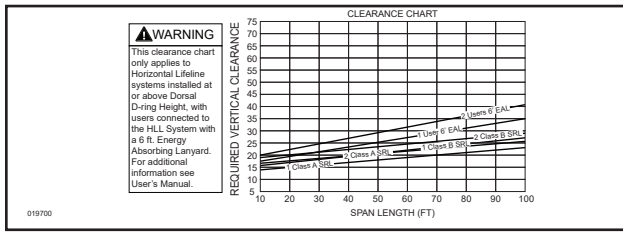

BARCODE

(30') 2 PERSON TEMPORARY KERNMANTLE HORIZONTAL LIFELINE SYSTEM

PART NUMBER: 019-8004 MFG DATE: XX/XX
 SERIAL NUMBER: XXXXXXX
 WWW.SAFEWAZE.COM

WARNING

Manufacturer's instructions supplied with this product at time of shipment must be read and understood prior to use. Ensure Horizontal Lifeline is installed at an elevations which will limit Free Falls to a maximum of 6 feet when using Energy Absorbing Lanyards, and installed overhead when using Self Retracting Lifelines. This equipment must be installed under the supervision of a Qualified Person. Inspect all connections prior to use and verify connecting components are installed correctly. Failure to make secure connections could result in serious injury or death. Not flame or heat resistant. Avoid contact with sharp and abrasive edges. Caution should be taken using this equipment near Hazardous Thermal, Electrical, or Chemical Sources. Equipment exposed to fall arrest forces should be immediately removed from service. Alteration or misuse of this product, or failure to follow instructions could lead to serious injury or death. **DO NOT REMOVE THIS LABEL.**

INSPECTION: SYSTEM MUST BE INSPECTED PRIOR TO EACH USE TO DETERMINE IF IT IS IN GOOD WORKING CONDITION WITH ALL SYSTEM CONNECTIONS PROPERLY SECURED. THE SYSTEM SHOULD BE INSPECTED AT LEAST MONTHLY BY A COMPETENT PERSON OTHER THAN THE USER. IF INSPECTION REVEALS A DEFECTIVE OR UNSAFE CONDITION, THE SYSTEM MUST BE REMOVED FROM SERVICE. THIS SYSTEM IS NOT USER REPAIRABLE.

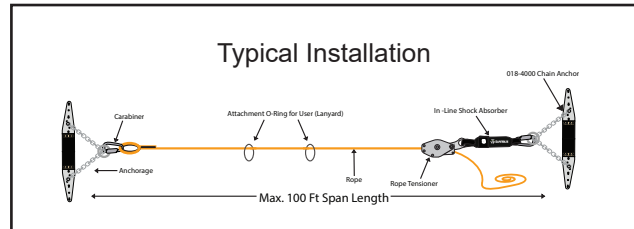
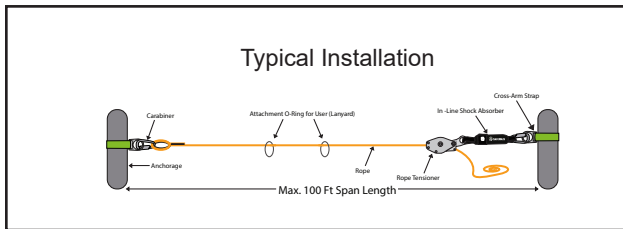

SPECIFICATIONS: THIS HORIZONTAL LIFELINE SYSTEM IS DESIGNED FOR USE BY UP TO TWO WORKERS. MAXIMUM WEIGHT FOR EACH WORKER INCLUDING TOOLS AND EQUIPMENT IS 310 LBS.

MATERIALS: Rope: Polyester Cover, Nylon Core
 Rope Tensioner: Steel
 Anchor Straps: Polyester
 Hardware: Steel

THIS HLL SYSTEM MEETS OSHA REQUIREMENTS FOR FALL PROTECTION WHEN USED AS DEFINED IN THE USER'S MANUAL.

Inspection Log
Do Not Remove Label

J	F	M	A	M	J	J	A	S	O	N	D



SafeWaze
322 Industrail Court
Concord, NC 28025

PHONE: 1-704-262-7893
FAX: 1-704-262-9051
EMAIL: info@safewaze.com

Web: safewaze.com