



ANSI	Z359.14-2021
------	--------------

OSHA	1910.140, 1910.66
------	-------------------



This manual is intended to meet the manufacturer's instructions as required by ANSI Z359.14-2021 and should be used as part of an employee training program as required by OSHA.

# TABLE OF CONTENTS

1.0	INTRODUCTION .....	5
2.0	APPLICATION .....	5
3.0	APPLICABLE SAFETY STANDARDS .....	5
4.0	WORKER CLASSIFICATIONS .....	6
5.0	TRAINING.....	6
6.0	LIMITATIONS AND REQUIREMENTS .....	6
7.0	INSPECTION FREQUENCY .....	7
8.0	PURPOSE .....	7
9.0	SPECIFICATIONS .....	7
10.0	ACTUAL ARREST DISTANCE/MIN REQUIRED FALL CLEARANCE..	8-11
11.0	SWING FALLS.....	12
12.0	FALL PROTECTION AND RESCUE PLAN .....	13
13.0	NORMAL OPERATIONS.....	13
14.0	COMPATIBILITY OF COMPONENTS .....	13
15.0	COMPATIBILITY OF CONNECTORS.....	13-14
16.0	USE .....	14-15
17.0	PERFORMANCE.....	15
18.0	MAINTENANCE, SERVICE, AND STORAGE .....	15
19.0	INSPECTION.....	15-16
20.0	LABELING .....	16

## User Information

Date of First Use: \_\_\_\_\_

Serial#: \_\_\_\_\_

Trainer: \_\_\_\_\_

User: \_\_\_\_\_

**Do not throw away these instructions!**  
**Read and understand these instructions before using equipment!**

## WARNINGS AND IMPORTANT PRECAUTIONS

User must read, understand, and follow all safety and usage information contained within this manual prior to use of this equipment. Failure to follow all safety and usage information can result in serious injury or death.

These instructions shall be provided to the user. User must read, understand, and follow all safety and usage information contained within this manual prior to use of this equipment. Failure to follow these instructions or improper use can result in serious injury or death.

### Intended Use:

The equipment covered in this manual is intended for use as part of a complete Personal Fall Arrest System (PFAS).

Use of this equipment for any other purpose, such as material handling, sports activities, or other action not described in these User Instructions is not approved by Safewaze. Use of this equipment in a manner outside the scope of those covered within this Manual can result in serious injury or death. The equipment covered in this manual is only to be used by trained personnel in workplace applications.



Safewaze Self Retracting Lifelines (SRLs) are part of a complete PFAS. Every user must be trained in the inspection, installation, operation, and proper usage of their complete PFAS. Unapproved or inappropriate use of Safewaze SRLs could result in serious injury or death. Refer to these instructions for the proper selection, installation, maintenance, and service of this equipment. For questions regarding use of this equipment beyond the scope of this manual, contact Safewaze.

#### The warnings below are designed to reduce the risks associated with the use of Safewaze SRLs:

- User must inspect the SRL prior to each use which includes a check for proper locking and retraction.
- If the inspection reveals an unsafe or defective condition, the SRL must be removed from service and destroyed or repaired as specified in this manual.
- If a Safewaze SRL is exposed to fall arrest or impact forces, it must be immediately removed from service and tagged "Unusable".
- Never allow slack to form in the SRL lifeline constituent. Never tie or knot the lifeline.
- Utilize extra caution to keep the lifeline free from any obstructions including but not limited to; surrounding objects, tools, equipment, moving machinery, co-workers, yourself, or possible impact from overhead objects that could come into contact with the lifeline or worker.
- Avoid making sudden or quick movements as this could cause the SRL to inadvertently lock.
- Do not use a Safewaze SRL in an environment where the fall path is obstructed. Use of a Safewaze SRL on slowly shifting or unstable material such as grain or sand, or within cramped or confined spaces, may not allow the worker to reach adequate speed for the SRL lock up, resulting in possible engulfment.
- Work directly under the anchor point as much as possible to reduce risk of striking an object due to swing fall.
- Unused leg(s) of a harness mounted SRL must be attached to the parking component on the front of the harness.
- If the PFAS is made up of components from different manufacturers, ensure that all components of the PFAS are compatible with each other and meet all applicable standards, regulations, or requirements. A Competent or Qualified Person should always review and approve the PFAS system prior to worker use.
- Avoid lifeline contact with sharp or abrasive surfaces.
- DO NOT use combinations of components or subsystems, or both, that may affect or interfere with the safe function of each other
- DO NOT alter equipment
- DO NOT misuse equipment
- User must have a written Rescue Plan and means at hand to implement it when using this equipment. All employees should be trained and knowledgeable in the Rescue Plan and Rescue Operations.
- Avoid exposure of this equipment to chemicals, high heat, severe cold or other harsh environments which may produce a harmful effect. If in doubt about serviceability of this equipment, contact Safewaze.
- DO NOT use D-ring extenders of ANY TYPE when using this product in a Leading Edge environment. Extenders can interfere with the proper function of Leading Edge SRLs and may result in serious injury or death.



#### Users should enact the precautionary measures listed below to reduce the inherent risks of working at height:

- Fall protection equipment that fails inspection must be removed from service and tagged "Unusable". The equipment should then be returned to Safewaze for repair / service (if applicable) or destroyed. For questions regarding service / repair of components, contact Safewaze.
- Never exceed the maximum allowable weight capacity of your fall protection equipment.
- Never exceed the maximum free fall distance of your fall protection equipment.
- Only Safewaze, or entities authorized in writing by Safewaze, may make repairs to Safewaze fall protection equipment.
- User(s) of Safewaze fall protection equipment must ensure that their health and physical condition allows them to withstand all forces and potential risks associated with working at heights. ANSI limits the weight capacity of fall protection equipment to a maximum of 310 lbs. Some equipment covered in this manual may indicate a weight capacity in excess of 310 lbs. Although some equipment may be rated to a higher capacity, it should be noted that heavier users are at an increased risk of serious injury or death. This being due to increased forces on the body during a fall, and the risk for accelerated onset of suspension trauma.
- Use of a body belt is NOT authorized for fall arrest applications. Use only a Full Body Harness (FBH).
- Always wear required personal protective equipment when installing, using, or inspecting this equipment.
- If conducting training operations with this equipment, ensure that a secondary fall protection system is installed and utilized in a manner that does not expose the trainee to unintended fall hazards.
- Immediately seek medical attention in the event a worker suffers a fall arrest incident.
- Certain subsystems may interfere with the proper operation of the equipment in this manual. Use only compatible connections. Contact Safewaze for questions regarding compatibility of equipment or components not covered in this manual.
- Avoid objects, equipment, or surfaces that could harm the user or equipment.
- User must ensure that there is adequate fall clearance when working at height.
- Extra precautions must be taken if working in the vicinity of moving machinery, electrical hazards, chemical hazards, sharp edges, explosive or toxic gases, extreme temperatures, or below overhead equipment or materials that could impact the user and his/her fall protection equipment.
- If work is conducted in a high heat environment, ensure that Arc Flash or other suitable fall protection equipment is utilized.





## 1.0 INTRODUCTION

Thank you for purchasing a Safewaze Self Retracting Lifeline (SRL). This manual must be read and understood in its entirety and used as part of an employee training program as required by OSHA or any applicable state agency. This manual and any other instructional material must be provided to the user(s) of the equipment. The user must understand how to use the SRL safely and effectively, as well as any related Personal Fall Arrest System (PFAS) components.

## 2.0 APPLICATION

Safewaze SRLs are intended for use as part of a complete personal fall arrest, restraint, work positioning, suspension, or rescue system. Safewaze SRLs are designed for a **single user** whose weight (including clothing, tools, and equipment) is:

**ANSI** 130-310 lbs. (59-141 kg)

**OSHA** Up to 420 lbs. (191 kg)

## 3.0 APPLICABLE SAFETY STANDARDS

Safewaze SRLs conform to the national standard(s) identified on their ID label. Refer to local, state, and federal (OSHA) requirements for additional information concerning the governing of occupational safety regarding Personal Fall Arrest Systems (PFAS). Examples of product labeling are illustrated in Figure 10 of this manual.

When used according to instructions, this product meets ANSI Z359.14-2021, OSHA 1910.140, OSHA 1910.66.

Applicable standards and regulations depend on the type of work being done, and also might include state-specific regulations. Refer to local, state, and federal (OSHA) requirements for additional information concerning the governing of occupational safety regarding Personal Fall Arrest Systems (PFAS).

**TABLE 2 - ANSI STANDARDS**

ANSI	Z359.14-2021	Safety Requirements for Self-Retracting Devices for Personal Fall Arrest and Rescue Systems
------	--------------	---

American National Standards Institute (ANSI) and Occupational Safety and Health Administration (OSHA):

The SRLs covered in this manual meet ANSI Z359.14-2021, and Occupational Safety and Health Administration (OSHA) regulations 1910.140, 1910.66. ANSI requires SRLs be classified according to their intended use and are tested either as Class 1 or Class 2 units. Dynamic performance testing begins by installing the SRL in a controlled test environment. With the SRL attached to a suitable anchorage, the lifeline constituent is attached to a test weight. The weight is then dropped to simulate a fall arrest event. **NOTE: SRL must be tested in all installation configurations allowed per its user instructions.** Test results are recorded.

Parameters recorded are:

- Arrest Distance (AD)
- Average Arrest Force (AAF)
- Maximum Arrest Force (MAF)

The Arrest Distance is the total vertical distance required to completely arrest a fall. The Arrest Distance includes the deceleration distance and the activation distance. The Average Arrest Force is the average of the forces applied to the body and the anchorage by the fall protection system. The Maximum Arrest Force is the maximum amount of force that may be applied to the body and the anchorage by the fall protection system. These tests are conducted in ambient conditions. The units must also be tested in extreme atmospheric conditions. There are three conditions: Cold, Hot, and Wet (Units saturated in water and tested). Separate units may be used for each test. All test results are recorded. This test data is then used to establish the fall clearance guidelines published in this user instruction manual.

### Class 1 and 2:

**Class 1:** Self-retracting devices which shall be used only on overhead anchorages and shall be subjected to a maximum free fall of 2 feet (0.6 m) or less, in practical application.

**Class 2:** Self-retracting devices which are intended for applications wherein overhead anchorages may not be available or feasible and which may, in practical application, be subjected to a free fall of no more than 6 feet (1.8 m) over an edge.

When the SRL is anchored overhead of the user, ANSI Z359.14-2021 specifies that both Class 1 and Class 2 SRLs shall have an arrest distance of less than 42 in. (1.1 m). Average arrest forces must not exceed 1,350 lbs. (612.35 kg). Conditioned testing of the units allows slightly higher Average Arrest Forces of 1,575 lbs. (714.41 kg), but Maximum Arrest Forces must always remain below 1,800 lbs. (816.47 kg).

When dynamically tested in accordance with requirements of ANSI Z359.14-2021, Class 1 and Class 2 Self-Retracting Devices must have an AAF of 1,350 lbs. (612.35 kg) or less, and an AD of less than 42 in. (1.1 m).

Class 2 SRL labels must include fall clearance table illustrations that include a diagram of the axes shown on the table. These labels shall be affixed to the product. Please see Section 10 of this user instruction manual for how to calculate your Minimum Required Fall Clearance (MRFC) using the affixed labels.

Classification information found on product labels is based on test results. Table 1 indicates the SRLs covered in this manual. NOTE: Arrest distance is one of several parts of the Minimum Required Fall Clearance (MRFC). MRFC is discussed in detail in Section 10. OSHA requires an SRL limit the free fall to 2 feet (0.6 m) or less. If the maximum free fall distance must be exceeded, the employer must document, based on test data, that the maximum arresting force will not be exceeded, and the personal fall arrest system will function properly.

## 4.0 WORKER CLASSIFICATIONS

Understand the definitions of those who work in proximity of or may be exposed to fall hazards or rescues.

**Qualified Person:** “Qualified Person” means one who, by possession of a recognized degree, certificate, or professional standing, or who by extensive knowledge, training, and experience, has successfully demonstrated his ability to solve or resolve problems relating to the subject matter, the work, or the project.

**Competent Person:** “Competent Person” means one who is capable of identifying existing and predictable hazards in the surroundings or working conditions which are unsanitary, hazardous, or dangerous to employees, and who has authorization to take prompt corrective measures to eliminate them.

**Authorized Person:** “Authorized Person” means a person approved or assigned by the employer to perform a specific type of duty or duties or to be at a specific location or locations at the job site.

**It is the responsibility of a Qualified or Competent person to supervise the job site and ensure safety regulations are complied with.**

## 5.0 TRAINING

This equipment is intended to be used by persons trained in its correct application and use. It is the responsibility of the user to assure they are familiar with these instructions and are trained in the correct care and use of this equipment. Users must be aware of the operating characteristics, application, limits, and the consequences of improper use.

## 6.0 LIMITATIONS AND REQUIREMENTS

When installing or using this equipment always refer to the following requirements and limitations:

- **Capacity:** Safewaze Self Retracting Lifelines are designed in compliance with ANSI Z359.14-2021 to meet the weight capacity range of (130-310 lbs), OSHA up to (420 lbs).
- **Anchorage:** Anchorages selected for fall arrest systems shall have a strength capable of sustaining static loads applied in the directions permitted by the system of at least:
  1. 5,000 lbs. (2267.9 kg) for non-certified anchorages, or
  2. Two times the maximum arresting force for certified anchorages.

When more than one fall arrest system is attached to an anchorage, the strengths set forth in (1) and (2) above shall be multiplied by the number of systems attached to the anchorage.

### From OSHA 1910.140, 1910.66

Anchorages used for attachment of personal fall arrest systems shall be independent of any anchorage being used to support or suspend platforms, and capable of supporting at least 5,000 lbs. (2267.9 kg) per user attached, or be designed, installed, and used as part of a complete personal fall arrest system which maintains a safety factor of at least two, and is under the supervision of a qualified person.

- **Locking Speed:** The nature of this equipment requires sufficient space in the working area to allow for the SRL to lock. Working in small or confined spaces may keep the user's body from reaching the speed needed to lock the SRL during a fall. Working on slowly shifting materials, such as grain or sand, may not allow the speed needed to cause the SRL to lock.
- **Free Fall:** Safewaze SRLs when used correctly with the unit anchored directly overhead and no slack in the lifeline, will limit the free fall distance to 0 ft. (0 m). In order to limit free fall distances, keep attachment of the SRL below Dorsal D-ring height to as minimal a distance as possible. Safewaze **Northstar Classic LE SRLs** are designed to allow for foot level tie-off, but never anchor the SRL at a level below the user's feet.
- **Swing Falls:** As the user moves laterally away from an overhead anchor point, the risks related to swing falls increase. The force of striking an object involving swing fall can in some instances generate more forces than a fall with the user wearing no fall protection equipment. Minimize swing falls by working as directly below the anchorage point as possible.
- **Fall Clearance:** Figure 2 Illustrates a Fall Clearance Calculation. Fall Clearance (FC) is the total combined values of Free Fall (FF), Deceleration Distance (DD), and a Safety Factor (SF). Safety Factor calculations may differ by manufacturer, but for the purposes of this manual, the Safety Factor is calculated at 2 ft.. The Safety Factor includes D-ring shift and Harness Stretch.

Tables 6-8 in this manual indicate the Minimum Fall Clearances when **Northstar Classic LE SRLs** are anchored overhead. For falls from a kneeling or crouched position an additional 3 ft. (1 m) of Fall Clearance is required. Tables 9-11 provide Minimum Required Fall Clearance information for Northstar Classic LE SRLs when used in a Leading Edge environment. If a Swing Fall Hazard exists, the total vertical fall distance will be greater than if the user had fallen directly under the anchor point. Section 11 and Table 12 in this manual provide information regarding Swing Fall hazards and additional Fall Clearance Requirements.

- **Hazards:** Extra precautions should be taken if this equipment is used in an environment where hazards exist. Hazards can include but are not limited to: moving machinery, high voltage equipment or power lines, caustic chemicals, corrosive environments, toxic or explosive gases, or high heat. Avoid working in an area where overhead equipment or personnel could fall and contact the user, fall protection equipment, or the lifeline. Areas where the user's lifeline may cross or tangle with the lifeline of another user should be avoided. Do not allow the lifeline to pass under arms or between the user's legs.
- **Sharp Edges:** Safewaze **Class 2 SRLs** are designed for use in both Overhead and Leading Edge Environments. Should a specific work area have extremely sharp edge(s) that may come into contact with the lifeline constituent of the SRL, a **Class 2 SRL** is required.

## 7.0 INSPECTION FREQUENCY

Either the Authorized Person<sup>1</sup> (User) or the Rescuer<sup>2</sup> must inspect this equipment prior to each use. The Inspection table (Table 3), should be used to determine proper inspection frequency. The Inspection Form (Page 17) describes proper inspection procedures. The Competent Person should record inspection results in the Inspection Form and retain a copy for records. (NOTE: User is advised to make copies of the Inspection Form on (Page 17) of this manual prior to filling out the form for the first time). Copies of the Inspection Form can be used for later Inspections. Annual inspections by a Competent Person other than the user must be recorded in the Inspection Log (Page 18).

- 1. Authorized Person:** A person assigned by the employer to perform duties at a location where such person will be exposed to a fall hazard.
- 2. Rescuer:** Person or persons other than the rescue subject acting to perform an assisted rescue by operation of a rescue system.



**NOTE:** Special rescue measures may be required for a fall over an edge.

**TABLE 3 - INSPECTION SCHEDULE PER ANSI Z359.14-2021**

Type of Use	Application Examples	Conditions of Use	Inspection Frequency Competent Person
Infrequent to Light	Rescue and Confined Space, Factory Maintenance	Good Storage Conditions, Indoor or Infrequent Outdoor Use, Room Temperature, Clean Environments	Annually
Moderate to Heavy	Transportation, Residential Construction, Utilities, Warehouse	Fair Storage Conditions, Indoor and Extended Outdoor Use, All Temperatures, Clean or Dusty Environments	Semi-Annually to Annually
Severe to Continuous	Commercial Construction, Oil and Gas, Mining	Harsh Storage Conditions, Prolonged or Continuous Outdoor Use, All Temperatures, Dirty Environment	Quarterly to Semi-Annually

## 8.0 PURPOSE

Self Retracting Lifelines are used as part of a PFAS. Safewaze SRLs are designed to safely arrest the user in a fall from height, while minimizing forces associated with what can be an extremely violent event. Safewaze SRLs are authorized for use with Horizontal Lifeline Systems but must NEVER be used as the lifeline constituent of an HLL System. Safewaze Class 1 SRLs must be used in overhead applications only and are not authorized for use below the Dorsal D-ring. Safewaze Class 2 SRLs are designed for both overhead and below Dorsal D-ring use with a maximum allowable Free Fall of 6 ft. (1.8 m).

## 9.0 SPECIFICATIONS

Northstar Classic LE SRL Minimum Breaking Strength	3,600 lbs. (1632.9 kg)
--	------------------------

Working Temperature Range	-40°F (-40°C) to 130°F (54°C)
---------------------------	-------------------------------

**TABLE 4 - MATERIALS**

<b>HOUSING</b>	Nylon and Glass Fiber
<b>DRUM</b>	Aluminum
<b>LIFELINE</b>	3/16" Galvanized Steel Cable
<b>ENERGY ABSORBER</b>	Polyester / PU
<b>SWIVEL</b>	Aluminum
<b>FASTENERS</b>	Aluminum / Steel / Stainless Steel
<b>LOCKING PAWLS</b>	Brass
<b>MAIN SHAFT</b>	Stainless Steel
<b>SPRINGS</b>	Stainless Steel

SRLs documented in this instruction manual meet the following Arrest Force and Arrest Distance maximums when tested in accordance with ANSI Z359.14-2021.

**TABLE 5 - PERFORMANCE REQUIREMENTS PER ANSI Z359.14-2021  
(CLASS 1 & CLASS 2 SRL)**

**CLASS 1**

Average Arresting Force	≤ 1,350 lbs. (612.3 kg)
Maximum Arresting Force	≤ 1,800 lbs. (816.5 kg)
Maximum Arrest Distance	42 in. (106.7 cm)

**CLASS 2**

Average Arresting Force	≤ 1,350 lbs. (612.3 kg)
Maximum Arresting Force	≤ 1,800 lbs. (816.5 kg)
Maximum Arrest Distance	Specified by Manufacturer

## 10.0 ACTUAL ARREST DISTANCE / MINIMUM REQUIRED FALL CLEARANCE

**Personal Fall Arrest:** Safewaze Class 2 SRLs can be used as part of a complete Personal Fall Arrest System (PFAS) for a maximum of one user. Only one user may be connected to an SRL. Avoid sharp and/or abrasive edges. If contact with an abrasive surface is unavoidable, proper edge protection must be used. The structure utilized for attachment must be capable of withstanding a load of 5,000 lbs. in all directions permitted by the system. The maximum allowable free fall is 6 ft.

### Actual Arrest Distance (AD):

Safewaze SRLs are tested in accordance with ANSI Z359.14-2021 test protocols. Table 6 indicates the Actual Arrest Distance (AD) of the Northstar Classic LE SRL series when anchored directly overhead with 0' Swing Fall. Testing was performed in four environmental conditions as specified per the ANSI Standard. ANSI Z359.14-2021 specifies a Maximum Allowed Arrest Distance of 42", which was used in the MRFC calculations for Figure 2 and Table 8. The actual arrest distances for the Northstar Classic LE SRLs indicated in Table 6, may allow a Qualified / Competent Person to determine if MRFCs can be adjusted based on jobsite conditions and/or environmental factors.

TABLE 6 - ACTUAL ARREST DISTANCES - OVERHEAD USE				
Model #	Ambient	Wet	Hot	Cold
FS-FSP9020	26" (66.0 cm)	25" (63.5 cm)	24" (60.9 cm)	37" (93.9 cm)
FS-FSP9030	28" (71.1 cm)	31" (78.7 cm)	22" (55.8 cm)	28" (71.1 cm)
FS-FSP9050	31" (78.7 cm)	29" (73.6 cm)	36" (91.4 cm)	41" (104.1 cm)

### Minimum Required Fall Clearance (MRFC):

Table 7 represents the MRFCs, as calculated, using the greatest Actual Arrest Distance provided in Table 6, when anchored directly overhead with 0' Swing Fall. The MRFC calculations in Table 7 are less than the standard ANSI MRFC calculation (See Figure 2 and Table 8). **Table 8 of this manual should be the first reference used to determine MRFC requirements!** However, a Qualified / Competent Person, using the information provided in Table 6 and clearances in Table 8, can determine if the MRFC requirements may be reduced or adjusted for a lower overall Fall Clearance.

TABLE 7 - ANSI ABOVE D-RING MINIMUM REQUIRED FALL CLEARANCE (MRFC)

Model #	MRFC
FS-FSP9020	7' 1" (2.16 m)
FS-FSP9030	6' 7" (2.01 m)
FS-FSP9050	7' 5" (2.26 m)

**NOTE:** A Qualified / Competent Person must determine if MRFCs can be adjusted based upon actual jobsite atmospheric conditions or additional factors!

FIGURE 1 - CLASS 1 SRL AXES DIAGRAM

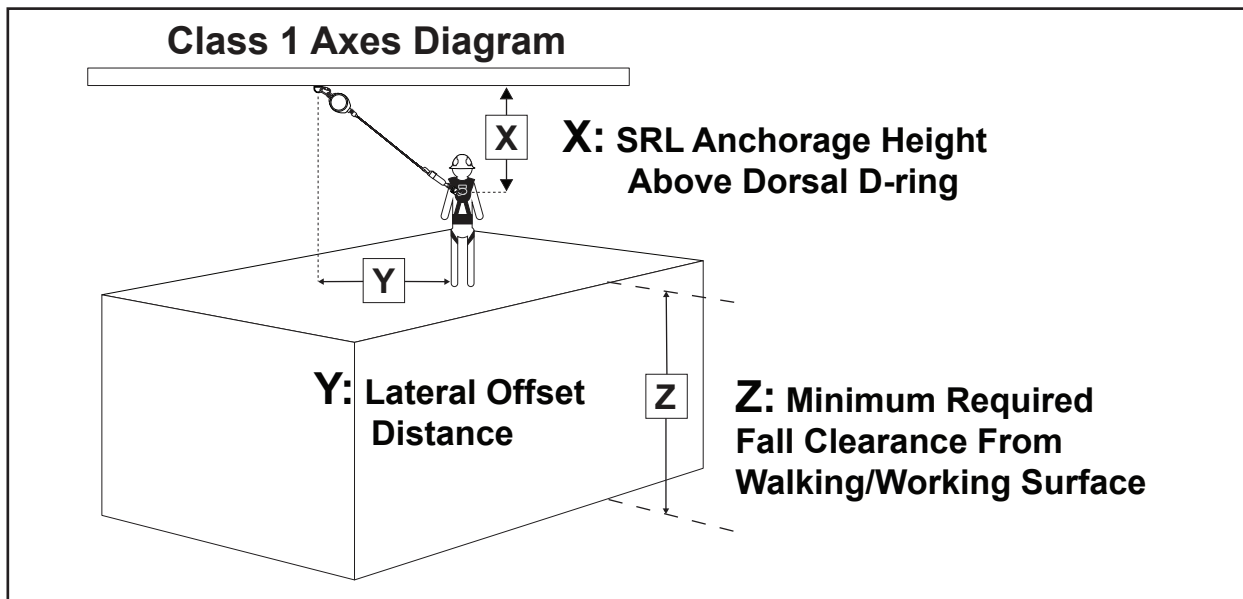

**Fall Clearance:** There must be sufficient clearance below the anchorage connector to arrest a fall before the user strikes the ground or an obstruction. Figure 2 illustrates a typical Fall Clearance calculation using the ANSI Maximum Allowed Arrest distance of 42". Fall Clearance calculations may vary dependent upon the SRL being used. It is essential that the correct Arrest Distance is used to determine Minimum Required Fall Clearance. **Table 8 indicates the MRFCs calculated per the ANSI Maximum Allowed Arrest Distance of 42".**

**FIGURE 2 - CALCULATE MINIMUM REQUIRED FALL CLEARANCE  
(CLASS 2 SRL - OVERHEAD USE)**

Northstar Classic LE SRL Minimum Required Fall Clearance (Overhead Use)		
<b>A</b>	<b>24" (61 cm)</b>	Maximum Allowed Free Fall per ANSI Z359.14-2021
<b>B</b>	<b>42" (107 cm)</b>	Maximum Allowed Arrest Distance per ANSI Z359.14-2021
<b>C</b>	<b>24" (61 cm)</b>	Safewaze Safety Factor
<b>D</b>	<b>7' 6" (2.3 m)</b>	Sub-Total for Minimum Required Fall Clearance
<b>E</b>	<b>0</b>	*Additional Fall Clearance for Swing Fall (If swing fall hazard exists refer to Table 12)
<b>F</b>	<b>7' 6" (2.3 m)</b>	Total Fall Clearance Required

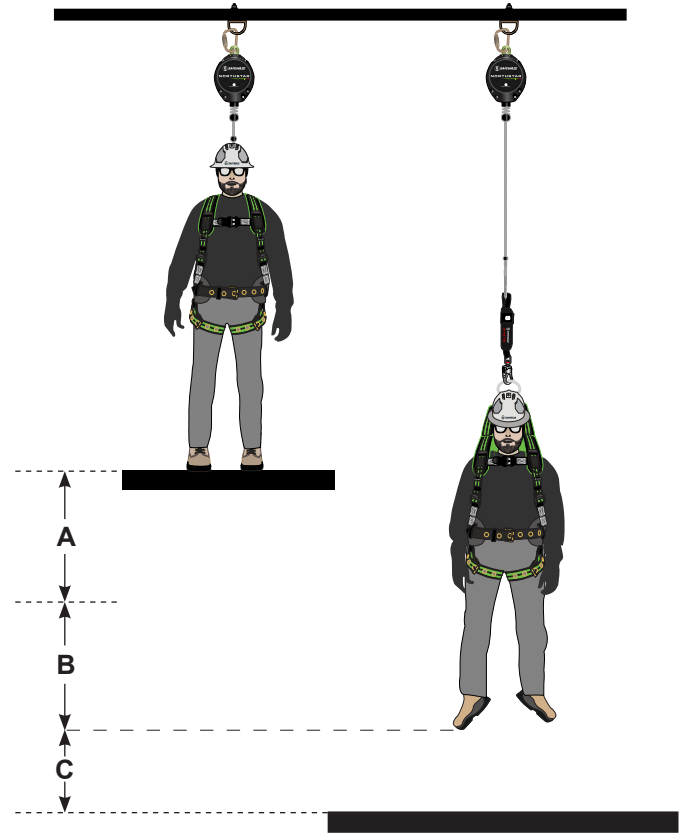

**TABLE 8 - MINIMUM REQUIRED FALL CLEARANCE - OVERHEAD USE**

Overhead Anchorage Clearance Chart - Read instructions for Complete Details Distance off Axis of Anchorage (Y)										
	0 ft (0 m)	2 ft (.6 m)	4 ft (1.2 m)	6 ft (1.8 m)	8 ft (2.4 m)	10 ft (3.0 m)	15 ft (4.6 m)	20 ft (6.1 m)	25 ft (7.6 m)	
SRL Anchorage Height Above Dorsal D-ring (X)	70 ft (21.3 m)	7' 6" (2.3 m)	7' 6" (2.3 m)	7' 7" (2.3 m)	7' 9" (2.4 m)	8' (2.4 m)	8' 3" (2.5 m)	9' 1" (2.8 m)	10' 3" (3.1 m)	11' 9" (3.6 m)
	60 ft (18.3 m)	7' 6" (2.3 m)	7' 6" (2.3 m)	7' 7" (2.3 m)	7' 9" (2.4 m)	8' (2.4 m)	8' 3" (2.5 m)	9' 3" (2.8 m)	10' 8" (3.3 m)	12' 6" (3.8 m)
	50 ft (15.2 m)	7' 6" (2.3 m)	7' 6" (2.3 m)	7' 8" (2.3 m)	7' 10" (2.4 m)	8' 1" (2.5 m)	8' 6" (2.6 m)	9' 8" (3 m)	11' 4" (3.5 m)	13' 4" (4.1 m)
	40 ft (12.2 m)	7' 6" (2.3 m)	7' 6" (2.3 m)	7' 8" (2.3 m)	7' 10" (2.4 m)	8' 3" (2.5 m)	8' 8" (2.6 m)	10' 2" (3.1 m)	12' 2" (3.7 m)	14' 8" (4.5 m)
	30 ft (9.1 m)	7' 6" (2.3 m)	7' 7" (2.3 m)	7' 9" (2.4 m)	8' 1" (2.5 m)	8' 6" (2.6 m)	9' 1" (2.8 m)	11' (3.4 m)	13' 7" (4.1 m)	16' 7" (5.4 m)
	20 ft (6.1 m)	7' 6" (2.3 m)	7' 7" (2.3 m)	7' 10" (2.4 m)	8' 4" (2.5 m)	9 ft (2.7 m)	9' 10" (3.0 m)	12' 6" (3.8 m)	15' 9" (4.8 m)	19' 6" (5.9 m)
	10 ft (3.0 m)	7' 6" (2.3 m)	7' 8" (2.3 m)	8' 3" (2.5 m)	9' 2" (2.8 m)	10' 3" (3.1 m)	11' 7" (3.5 m)	15' 6" (4.7 m)	19' 10" (6.1 m)	24' 4" (7.5 m)
	8 ft (2.4 m)	7' 6" (2.3 m)	7' 8" (2.3 m)	8' 4" (2.5 m)	9' 6" (2.9 m)	10' 9" (3.3 m)	12' 3" (3.7 m)	16' 6" (5 m)	21' (6.4 m)	25' 8" (7.8 m)

XX ft

Allowed  
Work Zone

XX ft

Warning

**WARNING!**  
WORKING IN THIS  
ZONE MAY  
RESULT IN  
SERIOUS INJURY  
OR DEATH

**Clearance Required (Z) - Includes 2 foot Safety Factor  
See Diagram for Illustration of X, Y, and Z axes**

**Fall Clearance Calculation for Northstar Classic LE SRLs:**

- Figure 3 Illustrates a typical Leading Edge Hazard with key distances represented by the Letters X, Y, and Z. The Letter X represents the Setback Distance of the anchor point to which the Leading Edge SRL is attached. Letter Y represents the distance along the Leading Edge where the user could be performing work operations. Finally, Letter Z represents the Fall Clearance distance required based upon the values of Letters X and Y.
- Table 9 provides Fall Clearance distances required when using a Safewaze Northstar Classic LE SRL in a Leading Edge environment. To determine your Fall Clearance requirements, find the value for your Setback Distance for Letter (X) on the left side of the chart. Determine your distance along the edge where work operations will be performed and select the appropriate value (Y) at the top of the chart. The point where these two values intersect within the chart, is the required Leading Edge fall clearance distance (Z).

**FIGURE 3 - CALCULATE MINIMUM REQUIRED FALL CLEARANCE  
(CLASS 2 SRL - LEADING EDGE USE)**

Minimum Required Fall Clearance in a Leading Edge environment is calculated using four measurements from the walking/working surface:

- Free fall (Height of Dorsal D-ring from walking/working surface)
- Arrest Distance
- Safety Factor
- Swing Fall

Table 9 is calculated using all of the above criteria and indicates the Minimum Required Fall Clearance. The calculations also factor in the Set Back Distance of the SRL from the edge, and Lateral Offset Distance.

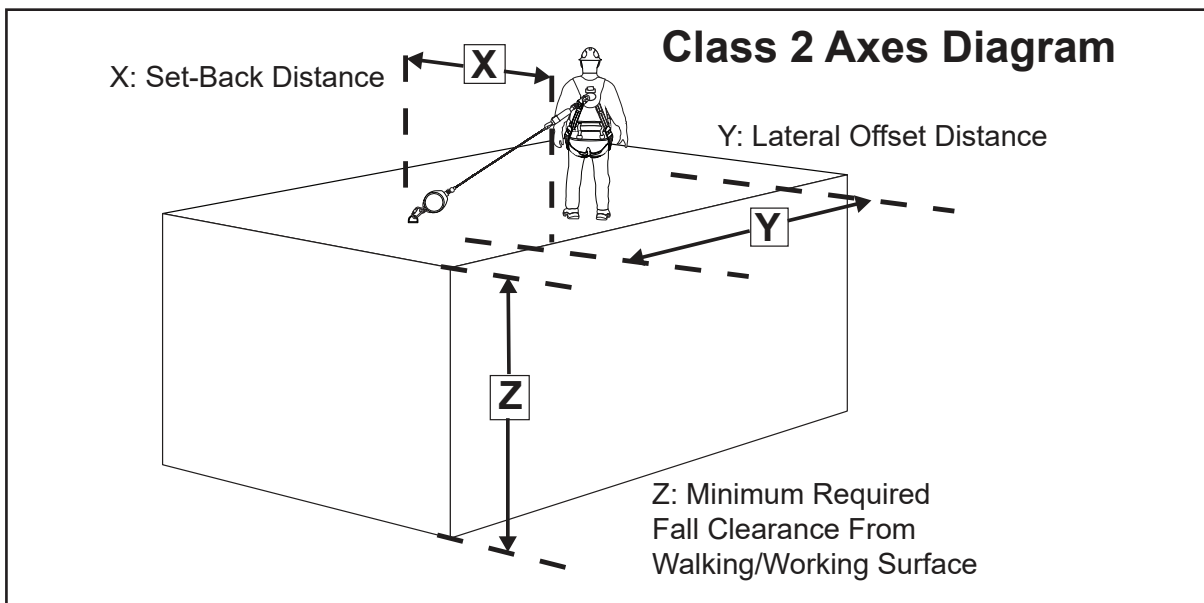

**TABLE 9 - MINIMUM FALL CLEARANCE - LEADING EDGE USE**

ALL UNITS

**Class 2 Clearance Chart - Read Instructions for Complete Details**

Distance off Axis of Anchorage (Y)

	0 Feet (0.0 m)	2 Feet (0.6 m)	4 Feet (1.2 m)	6 Feet (1.8 m)	8 Feet (2.4 m)	10 Feet (3.0 m)	12 Feet (3.7 m)	14 Feet (4.3 m)	16 Feet (4.9 m)	18 Feet (5.5 m)	20 Feet (6.1 m)
2 Feet (0.6 m)	15' 8" (4.8 m)	17' 8" (5.4 m)	19' 8" (6 m)								
4 Feet (1.2 m)	15' 8" (4.8 m)	17' 2" (5.2 m)	18' 2" (5.5 m)	19' 2" (5.8 m)							
6 Feet (1.8 m)	15' 8" (4.8 m)	16' 2" (4.9 m)	17' 2" (5.2 m)	18' 2" (5.5 m)	19' 2" (5.8 m)						
8 Feet (2.4 m)	15' 8" (4.8 m)	16' 2" (4.9 m)	16' 8" (5.1 m)	17' 8" (5.4 m)	18' 2" (5.5 m)	19' 2" (5.8 m)					
10 Feet (3.0 m)	15' 8" (4.8 m)	16' 2" (4.9 m)	16' 8" (5.1 m)	17' 2" (5.2 m)	17' 8" (5.4 m)	19' 2" (5.8 m)	20' 2" (6.1 m)				
15 Feet (4.6 m)	15' 8" (4.8 m)	16' 2" (4.9 m)	16' 2" (4.9 m)	16' 8" (5.1 m)	17' 8" (5.4m)	18' 2" (5.5 m)	20' 2" (6.1 m)	21' 4" (6.5 m)			

**WARNING! WORKING IN THIS ZONE MAY RESULT IN SERIOUS INJURY OR DEATH**

XX ft Allowed Work Zone

No Work Zone

**WARNING! WORKING IN THIS ZONE MAY RESULT IN SERIOUS INJURY OR DEATH**

**Clearance Required (Z) - Includes 2 foot Safety Factor**  
See Diagram for Illustration of X, Y, and Z axes



## Actual Arrest Distance (Leading Edge):

Safewaze SRLs are tested in accordance with ANSI Z359.14-2021 conditioning test protocols. Table 10 reflects the Actual Arrest Distance for each unit in the Northstar Classic LE SRL series, when subjected to Ambient, Wet, Hot, and Cold testing in a Leading Edge environment. Actual Arrest Distances for each unit in the Northstar Classic LE SRL series are indicated below.

**TABLE 10 - ACTUAL ARREST DISTANCES - LEADING EDGE USE**

Model #	Ambient	Wet	Hot	Cold
FS-FSP9020	98" (248.9 cm)	79" (200.6 cm)	99" (251.5 cm)	91" (231.1 cm)
FS-FSP9030	104.7" (265.9 cm)	88.6" (225 cm)	100.8" (256 cm)	91.3" (231.9 cm)
FS-FSP9050	102" (259 cm)	87" (220.9 cm)	99" (251.5 cm)	94" (238.8 cm)

## Minimum Required Fall Clearance (Leading Edge Use)

The Minimum Required Fall Clearance distances indicated in Table 11 are for Northstar Classic LE SRLs when anchored at foot level in a Leading Edge environment. The Minimum Required Fall Clearance (MRFC) indicated for each unit is calculated using the information provided in Table 10. The MRFC distances in Table 11 are calculated using the SRL's worst performance among the 4 environmental test conditions.

**TABLE 11 - ANSI BELOW D-RING MINIMUM REQUIRED FALL CLEARANCE (MRFC) - LEADING EDGE USE**

Model #	MRFC
FS-FSP9020	15' 4" (4.7 m)
FS-FSP9030	15' 8" (4.8 m)
FS-FSP9050	15' 6" (4.7 m)

**NOTE:** A Qualified Person must determine if MRFCs can be adjusted based upon actual jobsite atmospheric conditions or additional factors.

Northstar Classic LE SRLs have Leading Edge capabilities, and are tested in accordance with ANSI Z359.14-2021. Leading Edge SRLs are tested for horizontal use and falls over a steel edge without burrs. They have been designed for use in situations where a fall may occur over steel edges.

### Use of a Leading Edge SRL requires extra precautions which the user must observe:

- A fall over an edge may require specialized rescue measures.
- The anchor point for Leading Edge SRLs must be situated at the same height, or higher than the edge over which a fall may occur. An anchor point below the level of the edge is dangerous, as they cause the lifeline to redirect at a sharper than 90 degree angle (See Figure 4).
- Individuals whose weight is over 420 lbs. (191 kg) must not use this device in Leading Edge applications.
- The user(s) must not work on the far side of an opening opposite the Leading Edge SRL anchor point.
- The redirection angle of the lifeline at an edge over which a fall may occur shall be at least 90 degrees (See Figure 4).
- In evaluating your Leading Edge operations, ensure that work parameters are within the Maximum Free Fall Distance, Minimum Setback Distance, and Minimum Fall Clearance Required in a fall over an edge. These parameters are indicated on the Northstar Classic LE SRL Labeling.
- Work area relative to the anchor point, swing fall hazards, abrasion of the lifeline constituent on the edge, and a single anchor point, rather than an anchor point that allows horizontal movement, must all be considered.
- Maximum allowable Free Fall is 6 ft. (1.8 m)

**FIGURE 4 - ALLOWABLE CABLE REDIRECTION**

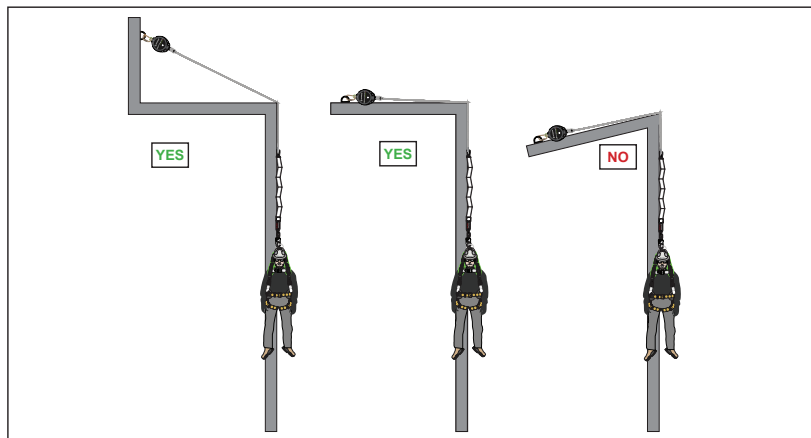

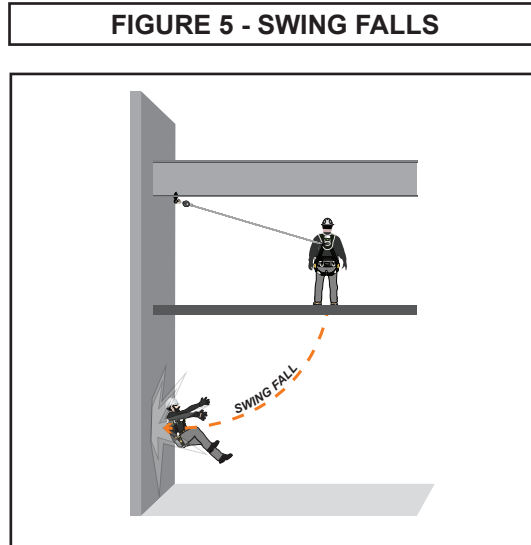

# 11.0 SWING FALLS

An anchorage point located in a position that is not directly over the user's fall location results in a Swing Fall (See Figure 5). Swing falls may result in the user striking an object with enough force to cause serious injury. Greater clearance is needed to ensure safety during a swing fall as vertical fall distance will be greater than a fall originating directly below the anchorage point. For help determining additional required fall clearance due to Swing Fall see Table 12.



**WARNING:** The risk of striking an object or obstruction is dramatically increased in the event of a swing fall. Failure to comply with this warning may result in serious injury or death.

**TABLE 12 - ADDITIONAL FALL CLEARANCE FOR SWING FALL HAZARDS (OVERHEAD USE)**

 Allowable Work Zone	 Allowable Work Zone with Enhanced Caution	 Not Allowed Work Zone																																																																																										
<p><b>Using Table 12:</b> Table 12 provides the ability for the user to determine additional fall clearance requirements if a Swing Fall Hazard is present when using the a Northstar Classic LE SRL in an overhead application. The Y-Axis represents the height the SRL is anchored above the user's Dorsal D-ring. The X-Axis represents lateral movement of the worker in relation to the SRL.</p> <p><b>Example - Northstar Classic LE SRL Anchored Overhead:</b> This example represents the user anchored <b>20' Overhead</b> (Up along the Y Axis) and <b>10' Laterally</b> (Along the X Axis). The intersection of these distances on the chart indicate an additional <b>28"</b> of fall clearance is required. This additional required fall clearance must be added to total fall clearance calculations.</p>																																																																																												
Y-AXIS	<table border="1" style="width: 100%; text-align: center;"> <tr> <td>70'</td> <td>0"</td><td>0"</td><td>1"</td><td>3"</td><td>6"</td><td>9"</td><td>19"</td><td>33"</td><td>51"</td> </tr> <tr> <td>60'</td> <td>0"</td><td>0"</td><td>1"</td><td>3"</td><td>6"</td><td>9"</td><td>21"</td><td>38"</td><td>60"</td> </tr> <tr> <td>50'</td> <td>0"</td><td>0"</td><td>2"</td><td>4"</td><td>7"</td><td>12"</td><td>26"</td><td>46"</td><td>70"</td> </tr> <tr> <td>40'</td> <td>0"</td><td>0"</td><td>2"</td><td>4"</td><td>9"</td><td>14"</td><td>32"</td><td>56"</td><td>86"</td> </tr> <tr> <td>30'</td> <td>0"</td><td>1"</td><td>3"</td><td>7"</td><td>12"</td><td>19"</td><td>42"</td><td>73"</td><td>109"</td> </tr> <tr> <td>20'</td> <td>0"</td><td>1"</td><td>4"</td><td>10"</td><td>18"</td><td><b>28"</b></td><td>60"</td><td>99"</td><td>144"</td> </tr> <tr> <td>10'</td> <td>0"</td><td>2"</td><td>9"</td><td>20"</td><td>33"</td><td>49"</td><td>96"</td><td>148"</td><td>202"</td> </tr> <tr> <td>8'</td> <td>0"</td><td>2"</td><td>10"</td><td>24"</td><td>39"</td><td>57"</td><td>102"</td><td>162"</td><td>218"</td> </tr> <tr> <td></td> <td>0'</td><td>2'</td><td>4'</td><td>6'</td><td>8'</td><td>10'</td><td>15'</td><td>20'</td><td>25'</td> </tr> </table>		70'	0"	0"	1"	3"	6"	9"	19"	33"	51"	60'	0"	0"	1"	3"	6"	9"	21"	38"	60"	50'	0"	0"	2"	4"	7"	12"	26"	46"	70"	40'	0"	0"	2"	4"	9"	14"	32"	56"	86"	30'	0"	1"	3"	7"	12"	19"	42"	73"	109"	20'	0"	1"	4"	10"	18"	<b>28"</b>	60"	99"	144"	10'	0"	2"	9"	20"	33"	49"	96"	148"	202"	8'	0"	2"	10"	24"	39"	57"	102"	162"	218"		0'	2'	4'	6'	8'	10'	15'	20'	25'
70'	0"	0"	1"	3"	6"	9"	19"	33"	51"																																																																																			
60'	0"	0"	1"	3"	6"	9"	21"	38"	60"																																																																																			
50'	0"	0"	2"	4"	7"	12"	26"	46"	70"																																																																																			
40'	0"	0"	2"	4"	9"	14"	32"	56"	86"																																																																																			
30'	0"	1"	3"	7"	12"	19"	42"	73"	109"																																																																																			
20'	0"	1"	4"	10"	18"	<b>28"</b>	60"	99"	144"																																																																																			
10'	0"	2"	9"	20"	33"	49"	96"	148"	202"																																																																																			
8'	0"	2"	10"	24"	39"	57"	102"	162"	218"																																																																																			
	0'	2'	4'	6'	8'	10'	15'	20'	25'																																																																																			
	X-AXIS																																																																																											



## 12.0 FALL PROTECTION AND RESCUE PLAN

When using this equipment, employers must create and maintain a Fall Protection and Rescue Plan and provide the means to implement those plans. The plans must be communicated to equipment users, authorized persons, and rescuers. These plans must meet ANSI Z359.2 "Minimum Requirements for a Comprehensive Managed Fall Protection Program." They should include the requirements and guidelines for the employer's managed Fall Protection Program. This would include eliminating and controlling fall hazards, duties and training, policies, fall protection procedures, rescue procedures, incident investigations, and evaluation of the program's effectiveness.

## 13.0 NORMAL OPERATIONS

During normal operations, the lifeline constituent of the SRL will extend and retract freely with no slack or hesitation as the worker moves at normal speeds. In the event of a fall, Safewaze SRLs are equipped with a speed sensing braking system. The braking system will activate, stopping the fall, and absorbing much of the energy created by the fall. Due to the speed sensing braking system, user(s) should avoid quick or sudden movements, as this may cause the SRL to inadvertently lock. If the user is performing operations near the end of the working length of the SRL, a reserve line is incorporated within the SRL to reduce fall arrest forces.

## 14.0 COMPATIBILITY OF COMPONENTS

Safewaze Fall Protection Equipment is designed for use with Safewaze components and subsystems only. A Qualified Person should make the determination of Safewaze equipment compatibility with equipment not manufactured by Safewaze. Replacement or substitution of equipment not manufactured by Safewaze, may degrade, or reduce the safety and reliability of the complete system.



**IMPORTANT:** Read and follow manufacturer's instructions for associated components and subsystems in your personal fall arrest system.

## 15.0 COMPATIBILITY OF CONNECTORS

Connectors are compatible with connecting elements when they have been designed to work together in such a way that their sizes and shapes do not cause their gate mechanisms to inadvertently open, regardless of how they become oriented. Connectors (hooks, carabiners, and D-rings) must be capable of supporting at least 5,000 lbs. (2267.9 kg). Connectors must be compatible with the anchorage or other system components. Do not use equipment that is not compatible. Non-compatible connectors may unintentionally disengage (See Figure 6). Connectors must be compatible in size, shape, and strength. Self-locking snap hooks and carabiners are required by ANSI Z359 and OSHA guidelines. Contact Safewaze if you have any questions about compatibility.



**NOTE:** SOME SPECIALTY CONNECTORS HAVE ADDITIONAL REQUIREMENTS. CONTACT SAFEWAZE WITH QUESTIONS.

**FIGURE 6 - UNINTENTIONAL DISENGAGEMENT**

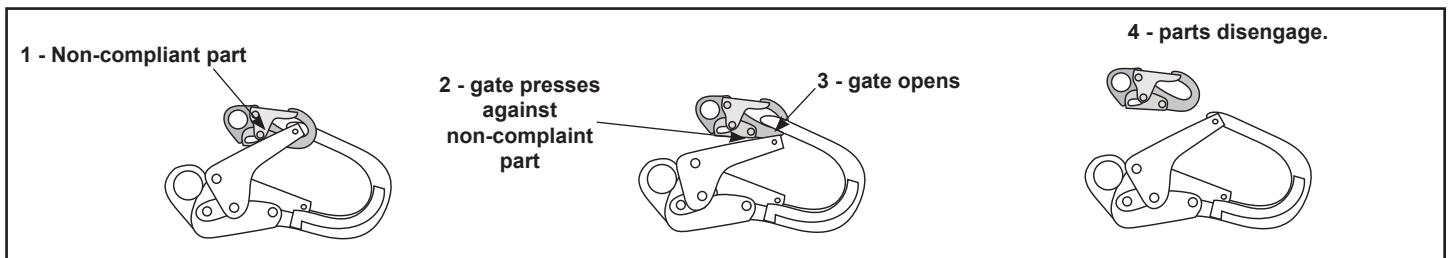

Using a connector that is undersized or irregular in shape (1) to connect a snap hook or carabiner could allow the connector to force open the gate of the snap hook or carabiner. When force is applied, the gate of the hook or carabiner presses against the non-compliant part (2) and forces open the gate (3). This allows the snap hook or carabiner to disengage (4) from the connection point.

## 15.1 MAKING CONNECTIONS

Snap hooks and carabiners used with this equipment must be double locking and/or twist lock. Ensure all connections are compatible in size, shape and strength. Do not use equipment that is not compatible. Ensure all connectors are fully closed and locked.

Safewaze connectors (snap hooks and carabiners) are designed to be used only as specified in each product's user's instructions. (See Figure 7) for examples of inappropriate connections. Do not connect snap hooks and carabiners:

- To a D-ring to which another connector is attached.
- In a manner that would result in a load on the gate (with the exception of Tie-Back hooks). NOTE: Large snap hooks must not be connected to objects which will result in a load on the gate if the hook twists or rotates, unless the snap hook complies with ANSI Z359.12 and is equipped with a 3,600 lbs. (1632.9 kg) gate. Check the marking on your snap hook to verify its compatibility.
- In a false engagement, where features that protrude from the snap hook or carabiner catch on the anchor, and without visual confirmation seems to be fully engaged to the anchor point.
- To each other.
- By wrapping the lifeline around an anchor and securing to lifeline except as allowed for Tie-Back models
- To any object which is shaped or sized in a way that the snap hook or carabiner will not close and lock, or that roll-out could occur.
- In a manner that does not allow the connector to align properly while under load.

**Only a Full Body Harness (FBH) may be used with this equipment.** The Full Body Harness must connect to the SRL via the dorsal D-ring. Safewaze SRLs are not rated for use with a body belt. Use of Safewaze SRLs with a body belt may result in injury. Figure 8 illustrates typical connection of Safewaze SRLs to the Dorsal D-ring of the Full Body Harness.



**NOTE:** Large throat snap hooks must not be connected to standard size D-rings or similar objects which will result in a load on the gate if the hook or D-ring twists or rotates, unless the snap hook complies with ANSI Z359.12 and is equipped with a 3,600 lbs. (1632.9 kg) gate. Check the marking on your snap hook to verify that it is appropriate for your application.

**FIGURE 7 - INAPPROPRIATE CONNECTIONS**

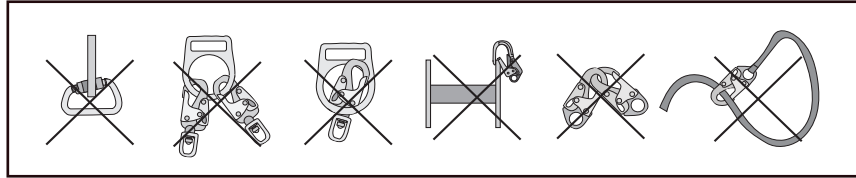

## 16.0 USE



**WARNING:** Contact Safewaze if you have questions regarding compatibility of this equipment that are not covered in this manual. Do not alter or misuse this equipment. Some subsystem components could affect the performance of the operation of this equipment. Do not anchor this product to moving machinery, hazards that include chemical, electrical or gaseous characteristics. Failure to comply with this warning could result in injury or death.



**WARNING:** Consult your doctor if there is reason to doubt your fitness to safely absorb the shock from a fall arrest. Age and fitness seriously affect a worker's ability to withstand falls. Pregnant women or minors must not use Safewaze SRLs. Failure to heed this warning may result in serious injury or death.

## 16.1 OPERATION

Inspect the SRL as described in Section 19, before using the equipment. Refer to Figure 8 for common system connections used with SRL applications. Mount the SRL to an approved anchor point. Ensure connections are compatible in size, shape, and strength. Ensure hooks are fully closed and locked. When the worker is fully attached, the worker is then free to move about within the recommended working area. If a fall occurs, the SRL will lock and arrest the fall. Upon rescue, remove the SRL from use. When working with an SRL, always allow the lifeline to retract back into the device in a controlled manner. Do not release the unit to "free-spin" back into itself.



**WARNING:** Do not tie or knot the lifeline. Avoid lifeline contact with sharp or abrasive surfaces. Inspect the lifeline frequently for cuts, fraying, burns, or signs of chemical damage. Dirt, contaminants, and water can lower performance of the lifeline. Use caution near power lines. Failure to comply with this warning may result in serious injury or death.

## 16.2 AFTER A FALL

As discussed in Section 12, employers must create and maintain a Fall Protection and Rescue Plan and provide the means to implement those plans. ANSI Z359.2 "Minimum Requirements for a Comprehensive Managed Fall Protection Program" specifies "The employer shall provide prompt rescue to all fallen authorized persons", with a recommended goal for rescue subject contact of less than 6 minutes. While there is no specific criteria for what constitutes a "prompt rescue", all workers must be trained on the site Rescue Plan, and all equipment associated with the Rescue Plan.

Any equipment exposed to the force of a fall, or that shows damage consistent with the effects of a fall, must be removed from service immediately. Equipment must then be serviced (See Section 18) if applicable, or disposed of (See Section 19).

## 16.3 BODY SUPPORT

A full body harness must be worn when using Safewaze SRLs.

## 16.4 SYSTEM CONNECTIONS

Figure 8 illustrates some typical examples of harness and anchorage connections for Northstar Classic LE SRLs. When using a snap hook to make a connection, ensure roll-out cannot occur (See Figure 6). Do not use snap hooks or carabiners that will not completely close over the anchor point. This includes traditional overhead anchor point tie-off, housing attachment to dorsal D-ring, and 100% tie-off. Follow the manufacturer's instructions supplied with each system component.



**WARNING:** Never connect the snap hook of one SRL to the lifeline of another SRL or lanyard. Failure to comply with this warning may result in equipment malfunction, serious injury or death.

**FIGURE 8 - SYSTEM CONNECTIONS**

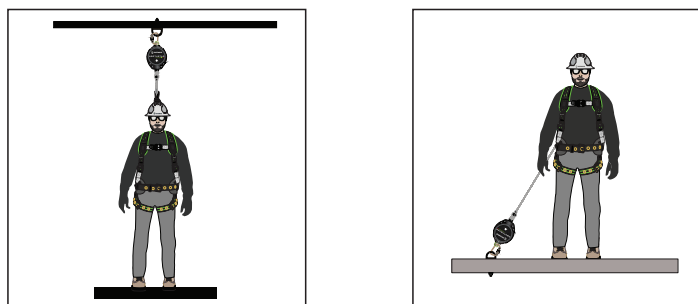

## 16.5 ANCHORAGE

Select an anchorage location with minimal free fall and swing fall hazards. Select a rigid anchorage point capable of sustaining static loads as defined in Section 6. Where anchoring overhead is not feasible, the user must ensure that a Class 2 SRL is used for any circumstance that requires anchoring of the SRL below the user's dorsal D-ring. **CLASS 1 SRLs ARE NOT AUTHORIZED FOR USE BELOW THE DORSAL D-RING OF A FULL BODY HARNESS!**



**IMPORTANT:** Do not allow the lifelines to pass under arms or between legs.

## 17.0 PERFORMANCE

Safewaze SRLs have been tested and certified to the performance requirements of the standard(s) identified on their ID labels. See Figure 10 for examples of product labeling.

## 18.0 MAINTENANCE, SERVICE, AND STORAGE

### 18.1 MAINTENANCE

Cleaning procedures for Safewaze SRLs are as follows:

Periodically clean the exterior of the SRL using water and a mild soap solution. Clean labels to maintain readability.

An excessive buildup of debris on the cable of the SRL may prevent the cable lifeline from fully retracting back into the housing. Improper retraction of the lifeline constituent of the SRL could create a potential free fall hazard.

Clean cable lifelines using an acid-free oil or petroleum jelly at regular intervals. Always wear gloves when servicing/inspecting steel cable SRLs.



**IMPORTANT:** If the lifeline comes in contact with acids or other caustic chemicals, remove the SRL from service and wash with water and a mild soap solution. Inspect the SRL (using the Inspection Form on Page 17) before returning to service.

### 18.2 SERVICE

Only Safewaze or entities authorized in writing by Safewaze, shall make repairs to this equipment. Remove the SRL from use if the SRL has been subjected to fall arrest forces or has been used to affect a rescue. If unrepairable dispose of the SRL as recommended in Section 19. For questions regarding disposal, service, or repair of Safewaze SRLs, contact Safewaze at (800) 230-0319.

### 18.3 STORAGE

Store Safewaze SRLs in a cool, dry, clean environment out of direct sunlight. Avoid areas where chemical vapors may exist. Thoroughly inspect the SRL after any period of extended storage.

## 19.0 INSPECTION

### 19.1 PRIOR TO EACH USE

Before each use ensure that the equipment is in good working condition. Inspect the unit to ensure it has not been damaged and that the unit pays out and retracts properly. Prior to each use, the braking system must be inspected. Grasp the body of the unit in one hand and the cable in the other. With a quick, jerking motion, pull down on the cable. The brake should engage, stopping movement almost immediately. Inspect the cable (using the Inspection Form on Page 17) and ensure that all connection hardware is working properly. Brake failure or unsatisfactory results during any portion of the inspection requires immediate removal of the SRL from service. Figure 11 points out key inspection areas of the Northstar Classic LE series of SRLs.

### 19.2 UNSAFE OR DEFECTIVE CONDITIONS

Figure 9 shows examples of equipment damage. Equipment inspectors must be trained to look for damage as illustrated, as well as other damage that may occur. If inspection reveals an unsafe or defective condition remove the SRL from service.

**FIGURE 9 - EXAMPLES OF EQUIPMENT DAMAGE**



Kinked Wire Rope

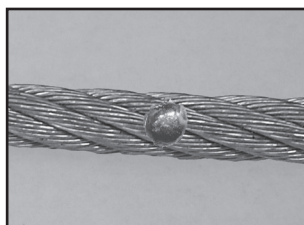

Welding Spatter

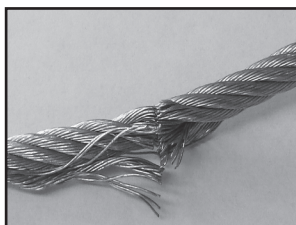

Broken Wires



Bird-Caging

# 19.3 PRODUCT LIFE

The working life of Safewaze SRLs are determined by work conditions, care, maintenance, and proper inspections. As long as the SRL passes inspection, and is not involved in a fall arrest event, it may remain in service.

# 19.4 DISPOSAL

Dispose of the Safewaze SRL if it has been damaged by fall arrest forces or inspection reveals an unsafe or defective condition that cannot be repaired by an authorized Safewaze Service Center. Before disposing of the SRL, cut the lifeline in half so that it is not mistakenly reused. For questions regarding disposal, service, or repair of Safewaze SRLs, contact Safewaze at (800) 230-0319.

# 20.0 LABELING

**FIGURE 10 - LABELING**

**Northstar Classic Leading Edge Series**



**DISCLAIMER**  
In accordance with ANSI Z359.14-2021 subsection 5.2.9, this warning label shall be included with each Class 2 SRL.

**WARNING:** This class 2 self-retracting device, when attached to a foot-level anchorage, poses significant risk of injury. The user, the competent person and/or qualified person should all acknowledge that normal use of this device **MAY NOT PREVENT A SERIOUS INJURY**.

Failure to follow all manufacturer's instructions and warnings may result in serious injury or death.



**MODEL #:** FS-FSP9020  
**DESCRIPTION:** Northstar Classic LE 20' Cable SRL

**SERIAL #:** XXXXXXXX **MFG DATE:** XXXXXXXX

**SPECIFICATIONS:** Materials: Steel and aluminum hardware, nylon & glass fiber housing, and 3/16" galvanized steel cable  
Working length: 20 ft. (6.1 m)  
Capacity: ANSI 130-310 lbs. (58.97-140.61 kg), OSHA 420 lbs. (190.51 kg), including clothing, tools, & equipment  
Average arrest force: 1360 lbs. (612.35 kg)  
Max. arrest force: 1800 lbs. (816.47 kg)  
Actual arrest distance: <math>90\text{ in. (231.5 cm)}</math>  
Min. free fall distance: 72 in. (182.88 cm)  
Min. required fall clearance: 15.3 ft. (4.7 m) \*See charts for more info  
Standards: ANSI Z359.14-2021, OSHA 1910.140 and OSHA 1910.66

**CLASS 2 UNIT**  
(Anchor above or below dorsal D-ring)

**MUST FOLLOW ALL MANUFACTURER'S INSTRUCTIONS INCLUDED WITH THIS EQUIPMENT. DO NOT REMOVE LABEL.**

**WARNING:** This is a single user fall arrest device. Device must be inspected prior to each use. Connection of this device to a full body harness is to be made to the dorsal D-ring only. User must ensure that any connection to anchorage is properly secured prior to use. Make only compatible connections. Dual connections shall only be used for 100% tie-off transitions. Refer to instruction manual for minimum anchorage strength requirements. Elevate anchorage to reduce the fall clearance and limit risk when possible. Fall clearances must be calculated by a competent person prior to use. Ensure adequate fall clearance exists to avoid contact with lower level or obstructions. Avoid using fall hazards by working directly under anchorage. If possible, avoid exposure to sharp or serrated structural edges to prevent damage to the lifeline. Avoid chemical, thermal and/or electrical hazards. This product is suitable for use horizontally and with horizontal lifelines. Adhere to the hierarchy of controls in Z359.2.

**USER MUST READ AND UNDERSTAND ALL INSTRUCTIONS AND WARNINGS INCLUDED WITH THIS EQUIPMENT. DO NOT REMOVE LABEL.**

DO NOT ATTEMPT TO SERVICE OR REPAIR THIS UNIT CONTACT SAFEHAZE FOR SERVICE OR REPAIR INFORMATION: Device must be inspected prior to each use in accordance with the manufacturer's instructions. Perform the Locking Function Test (sharp pull test) and retraction test. Inspect the device for label legibility, any evidence of damage or defects, and missing components or parts. Inspect all components of device including the housing, connectors, fasteners, and the entire length of the lifeline for any damage or defects. Refer to instruction manual for inspection frequency. Unit must be removed from service if exposed to fall arrest forces. If visual fail indicator is deployed, immediately remove unit from service.

J	F	M	A	M	J	J	A	S	O	N	D

Inspection Log - Do Not Remove Label

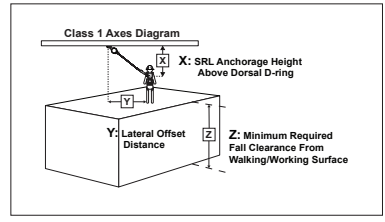
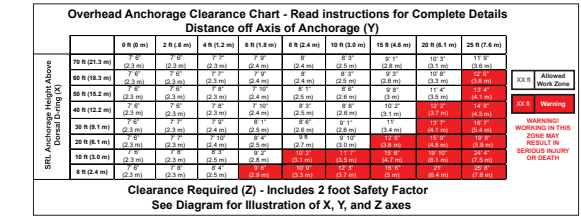
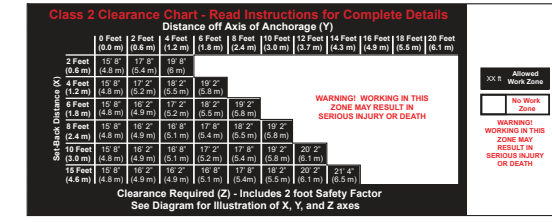
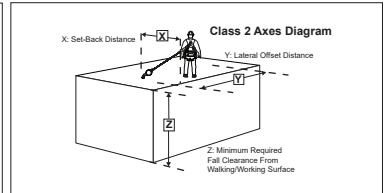

**FIGURE 11 - INSPECTION DIAGRAM**

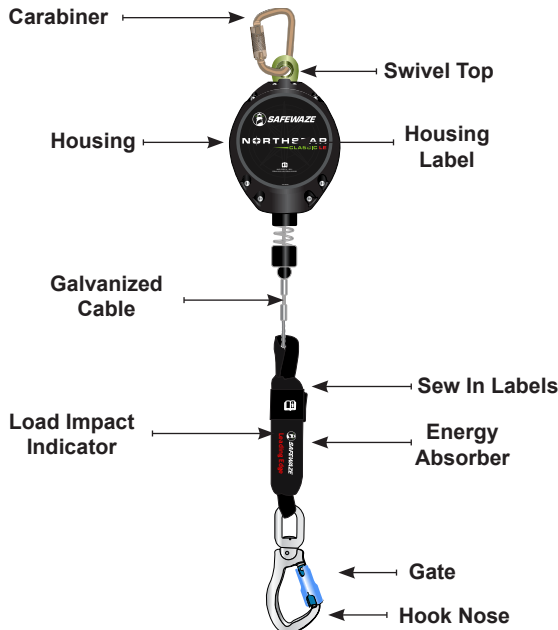

Key visual indicators that a Northstar Classic Leading Edge SRL has been exposed to Fall Arrest forces

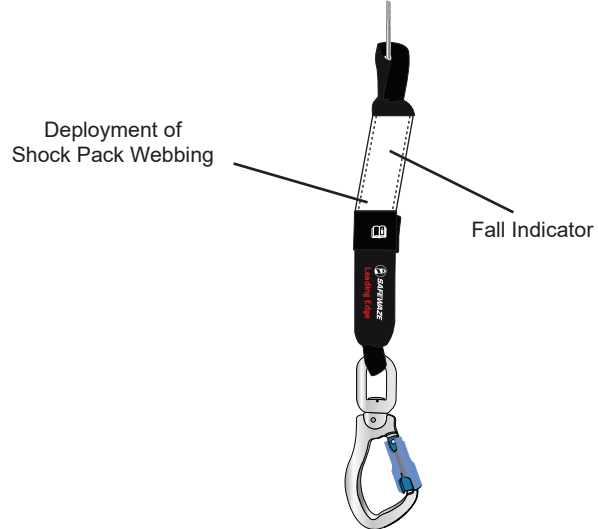



Manufacturer: \_\_\_\_\_

Company: \_\_\_\_\_

Model Number: \_\_\_\_\_

Name of Inspector: \_\_\_\_\_

Description: \_\_\_\_\_

Signature: \_\_\_\_\_

Serial Number: \_\_\_\_\_

Date of Inspection: \_\_\_\_\_

Lot Number: \_\_\_\_\_

In-Service Date: \_\_\_\_\_

Date of Manufacture: \_\_\_\_\_

Lifeline Material:  Galvanized Steel  Stainless Steel  Web

### LABELS & MARKINGS

**PASS** **FAIL** **NOTE**

	PASS	FAIL	NOTE
Label (Intact and Legible)	<input type="checkbox"/>	<input type="checkbox"/>	<input type="checkbox"/>
Appropriate ANSI / OSHA / CSA Markings	<input type="checkbox"/>	<input type="checkbox"/>	<input type="checkbox"/>
Inspections are Current / Up-to-Date	<input type="checkbox"/>	<input type="checkbox"/>	<input type="checkbox"/>
Date of First Use	<input type="checkbox"/>	<input type="checkbox"/>	<input type="checkbox"/>

### SHOCK PACK (IF PRESENT)

**PASS** **FAIL** **NOTE**

	PASS	FAIL	NOTE
Cover / Shrink Tube (Don't Cut or Remove)	<input type="checkbox"/>	<input type="checkbox"/>	<input type="checkbox"/>
Damage / Fraying / Broken Stitching	<input type="checkbox"/>	<input type="checkbox"/>	<input type="checkbox"/>
Impact Indicator (Signs of Deployment)	<input type="checkbox"/>	<input type="checkbox"/>	<input type="checkbox"/>

### HOUSING

**PASS** **FAIL** **NOTE**

	PASS	FAIL	NOTE
Attachment Point	<input type="checkbox"/>	<input type="checkbox"/>	<input type="checkbox"/>
Nuts / Bolts / Rivets / Screws	<input type="checkbox"/>	<input type="checkbox"/>	<input type="checkbox"/>
Evidence of Damage (Dents / Cracks / Rust)	<input type="checkbox"/>	<input type="checkbox"/>	<input type="checkbox"/>

### LIFELINE (WEB OR CABLE)

**PASS** **FAIL** **NOTE**

	PASS	FAIL	NOTE
Termination (Stitch, Splice, or Swage)	<input type="checkbox"/>	<input type="checkbox"/>	<input type="checkbox"/>
Cuts / Fraying / Broken Stitching	<input type="checkbox"/>	<input type="checkbox"/>	<input type="checkbox"/>
Excessive Wear	<input type="checkbox"/>	<input type="checkbox"/>	<input type="checkbox"/>
Cable Separating / Bird-Caging	<input type="checkbox"/>	<input type="checkbox"/>	<input type="checkbox"/>
Entire Length Retracts Smoothly	<input type="checkbox"/>	<input type="checkbox"/>	<input type="checkbox"/>
Test Braking / Locking Function	<input type="checkbox"/>	<input type="checkbox"/>	<input type="checkbox"/>

### CONNECTORS

**PASS** **FAIL** **NOTE**

	PASS	FAIL	NOTE
Connector (Self-Closing & Locking)	<input type="checkbox"/>	<input type="checkbox"/>	<input type="checkbox"/>
Impact Indicator	<input type="checkbox"/>	<input type="checkbox"/>	<input type="checkbox"/>
Hook Body / Rivets	<input type="checkbox"/>	<input type="checkbox"/>	<input type="checkbox"/>
Corrosion	<input type="checkbox"/>	<input type="checkbox"/>	<input type="checkbox"/>
Pitting / Nicks	<input type="checkbox"/>	<input type="checkbox"/>	<input type="checkbox"/>

### SELF-RETRACTING DEVICES

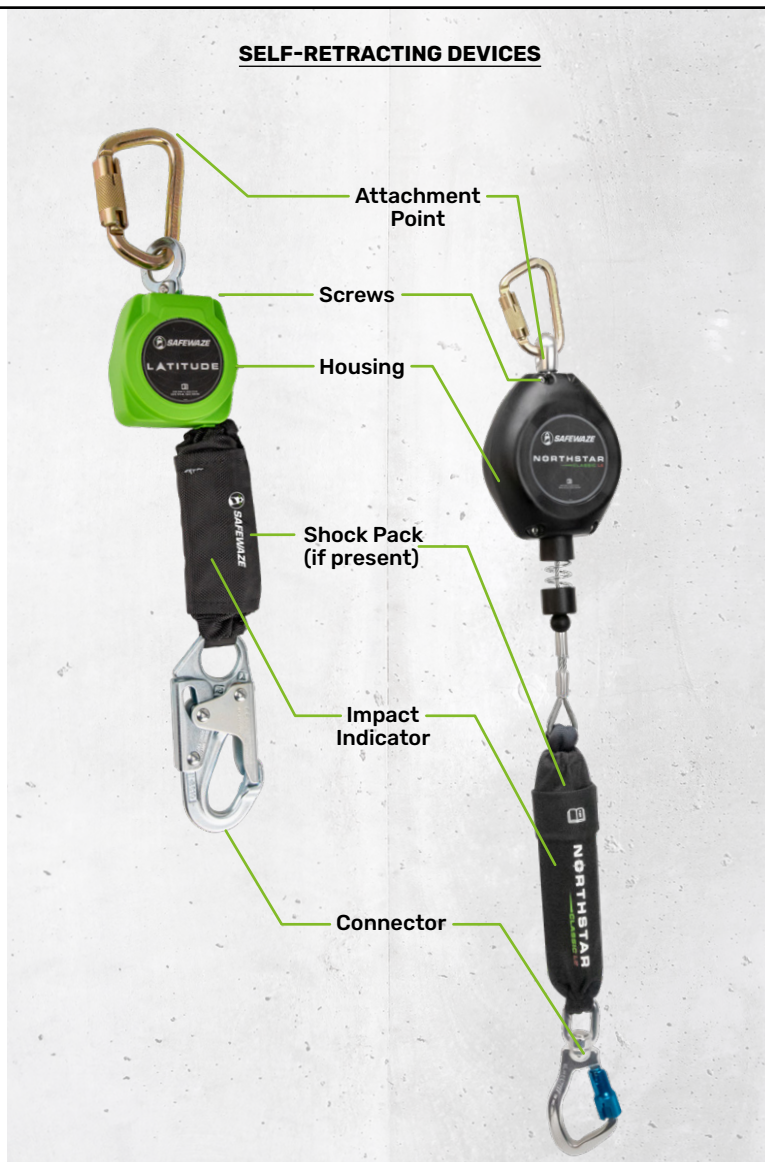

### NOTES

---



---



---



---



THIS PAGE INTENTIONALLY LEFT BLANK



**Safewaze**  
**225 Wilshire Ave SW**  
**Concord, NC 28025**

**PHONE: 1-800-230-0319**

**FAX: 1-704-262-9051**

**WEB: [safewaze.com](http://safewaze.com)**  
**EMAIL: [info@safewaze.com](mailto:info@safewaze.com)**