



Owner's manual

# *Tranquility II*

---

Adjustable bed



SERIAL NUMBER: \_\_\_\_\_

(Place your serial number here for ready reference)



# Table of contents

---

<b>Safety precautions</b>	<b>4</b>
<b>Parts list</b>	<b>6</b>
<b>Installation guide</b>	<b>7</b>
<b>Remote control guide</b>	<b>12</b>
<b>Special function</b>	<b>15</b>
<b>Troubleshooting</b>	<b>16</b>
<b>Warranty</b>	<b>18</b>
<b>Registration</b>	<b>19</b>

## ***Model Number: MA004TD03***

This product and all our bedding products are covered by one or more of the following issued and pending U.S. patents including Nos. 9706848, 9744088, 8209801, 9795223, 8769739, 8209800, 9706848, 8769739, D663968, and other patents pending.

Photos are for illustration purposes only.

COPYRIGHT © 2024 by Rize Home, LLC.

02.15.2024



# Safety precautions

## Attention!

IMPORTANT SAFETY INSTRUCTIONS.  
PLEASE READ THESE INSTRUCTIONS THOROUGHLY BEFORE USING THIS PRODUCT.

### Electrical safety

Always unplug this adjustable bed from the electrical outlet before any cleaning of the bed. To safely disconnect, make sure all controls are in the off position, then remove the plug from the outlet.

Keep cord away from heated surfaces. Keep air openings free of lint, hair and the like. Never operate when air openings are blocked. Never drop or insert any object into any opening. Use only indoors.

Cease use of this adjustable bed and contact the Customer Care Center for repair if: (1) it has a damaged cord or plug, (2) it is not working properly, (3) it has been dropped or damaged, or (4) it has been dropped into water.

### Grounding safety

To reduce the risk of electric shock, electrical fire, or faulty operation of this product, your adjustable bed may feature a polarized plug meant to be used only with a grounded electrical outlet. If this plug does not fit into your outlet, contact a qualified electrician to install a properly grounded outlet. Failure to use a properly grounded outlet for this product will compromise this important grounding safety feature. The use of adapters is not recommended unless the outlet is checked by a qualified electrician to ensure the proper grounding of the adapter. NOTE: Unauthorized modifications to this product could void the electrical portion of your warranty.

### Warranty warning!

This bed is specifically designed to require no maintenance by you, the user. Any opening or tampering with the control box, motors, or hand controls (with the exception of the battery compartment if equipped) will result in a void of the warranty. Only those authorized may conduct repairs or part replacement on your adjustable bed. Unauthorized modifications to this product could void the electrical portion of your warranty.

### In-home use only

This adjustable bed is designed exclusively for in-home use.

HOSPITAL DISCLAIMER: It is NOT designed for hospital use and is NOT designed to meet hospital standards. Do not use this bed with TENT TYPE oxygen therapy equipment or use near explosive gases.

### Important safety features

Weight fail safe feature: In the case that an overload of weight is placed on the head or foot mechanism, the control unit will automatically stop all functions. The control unit will automatically resume all functions 30 seconds after excess weight is removed.

The recommended weight limitations for your adjustable bed is up to 850 lbs. on all sizes. For your adjustable bed to structurally support the recommended weight, weight must be distributed evenly across the head and foot sections. The adjustable bed will not and is not intended to support or lift this amount in just the head or foot section. Dependent on the size and/or model of mattress, the available weight limit may be less.

Locking caster feature: This adjustable bed may be equipped with special locking casters. For your safety, these casters will prevent bed movement when all casters are in the locked position. To lock casters, push down the safety latch on the caster. To resume product mobility, lift the safety latch up.

NOTE: If your adjustable bed is positioned on a hard floor surface such as hardwood or tile, it is strongly recommended that rubber caster cups or carpet squares are placed under the casters in addition to locking them in place. Casters will not roll when locked, but may slide on an uncarpeted surface.

### User-serviceable parts

This bed is specifically designed to have no maintenance by you, the user. Therefore, you are encouraged not to open any motors, alter the wiring, or adjust, modify or change the structure of the product, as it will void the warranty.

### Radio frequency is 2.4 ghz

FCC compliant device complies with part 15 of the FCC Rules. Operation is subject to the following two conditions: (1) This



FOR OPTIMAL SAFETY, YOUR ADJUSTABLE BED SHOULD BE PLUGGED INTO A SURGE PROTECTOR (not supplied with this adjustable bed).



# Safety precautions

---

device may not cause harmful interference, and (2) this device must accept any interference received, including interference that may cause undesired operation.

**IMPORTANT NOTE:** To comply with the FCC RF exposure compliance requirements, no change to the antenna or the device is permitted. Any change to the antenna or the device could result in the device exceeding the RF exposure requirements and void user's authority to operate the device.



## Consumers with pacemakers

It is possible that the (optional) vibrating feature of this adjustable bed may be misinterpreted by some pacemakers as movement and/or exercise. This is common with any product that produces a vibrating motion, and may or may not affect your pacemaker. Please consult your physician with any concerns.

## Product ratings

**Lift Motor Restrictions:** The lift motors in this bed are NOT designed to operate continuously for more than two (2) minutes over a twenty (20) minute time period, or approximately 10% duty cycle. To ensure reliable functionality and full life of this product, do not attempt to exceed these limits.

**NOTE:** Attempting to circumvent or exceed this rating will shorten the life expectancy of the product and may void the warranty.

The structure of the bed will support the recommended weight when distributed evenly across the bed. The head and foot sections are not designed to individually support or lift this amount of weight. For optimal performance, entering and exiting the adjustable bed with the bed in the flat or level position is recommended.

**NOTE:** Exceeding the recommended weight restrictions could damage your adjustable bed and void your warranty.



## Small children and pets warning

Immediately dispose of all packing materials as it can pose a smother risk to small children and pets. Injury could occur also if children or pets are permitted to play on or under the bed. Do not allow children to operate this bed without adult supervision.

## Lift warning

Do not sit on the head or foot sections while in the raised position, or during lift or lowering cycles.

## Moving after installation

Do not place adjustable bed vertically on its head or foot sections. This may cause injury to persons or damage to the adjustable bed. Two people are required for moving this adjustable bed due to its heavy weight.

## Safety

When an overload of weight is placed on the head or foot mechanism, the control unit will automatically stop all functions. The control unit will automatically resume all functions after the excess weight is removed.

Massage motors, if any, will automatically shut off after running continuously for 15 minutes. All massage functions will be operational again after 5 minutes.

**NOTICE:** The changes or modifications not expressly approved by the party responsible for compliance could void the user's authority to operate the equipment.

Read the Owner's Manual carefully and completely before operating the product. Electric shock may occur if electrical components are not installed or operated according to these guidelines.

**SAVE THESE INSTRUCTIONS.** Proper operation of your adjustable bed is necessary to ensure the long life and durability you expect from a high-quality product. The manufacturer has tested and inspected this product prior to shipment.

## Parts list

---

Before discarding any packing materials, check the adjustable bed carton and verify that all items in the parts list are included.



Remote control (1)



AAA batteries (2)



8" + 3" + 2" legs (6) \*

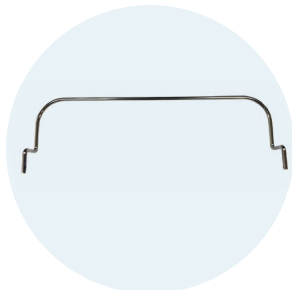

Mattress retainer bar (1)



Anti-skid pads



Bed leg strap (1) \*\*

\* The leg comes assembled as one whole leg with the option of removable leg extenders.

\*\* Only available with Twin XL, Split Cal King, and Split Queen bed sizes.

# Installation guide

---

## Setting up your adjustable bed

1 Open the box.

2 Lift the folded adjustable bed out of the box, place it on a flat floor and unfold it.

**NOTE:** Hold the edge of the bed when unfolding it. Do not hold the metal frames to avoid potential injury.

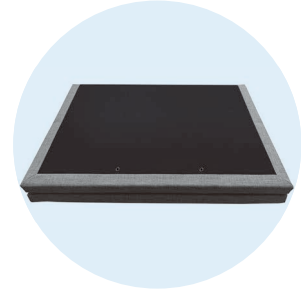

3 Remove any accessory boxes from inside the frame. Remove the legs, retainer bracket, and power supply attached to the adjustable bed.

**NOTE:** Take note of the orange zip ties holding the frame near the head and foot section of the bed. You will cut these ties later in the setup.

If you are installing the adjustable bed on a platform or slatpack bedding system, do not install the legs. Proceed to step 5.



4 Attach the bed legs to the adjustable bed by threading them in a clockwise direction into the pre-drilled holes on the frame.

**NOTE:**

- The legs come assembled as one whole leg with the option of removable leg extenders.
- Tighten the bed legs. After using the bed for a period of time or when the bed wobbles unsteadily, check the legs and tighten them again if necessary.

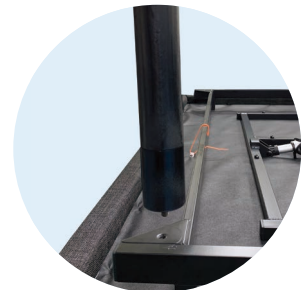

**NOTE:** For safety reasons, lifting of the adjustable bed must always be performed by two (2) people; and the unit should always be on a flat surface before opening.



# Installation guide

---

- 5 Remove and extend the power cord from the frame.

If you are installing your adjustable bed on a platform or slatpack bedding system, apply anti-skid pads to the frame first. See "Applying anti-skid pads for platform bed use" on page 11.

- 6 Lift one side of the bed and then turn it over carefully so the top side is now facing up.

**NOTES:**

- Do not lift the bed from the head deck to avoid damage to the adjustable bed.
- When turning the bed over, hold the frame and not the edges of the bed to avoid any damage.
- If you installed bed legs, do not rest the bed on its side so the weight may not damage the legs.

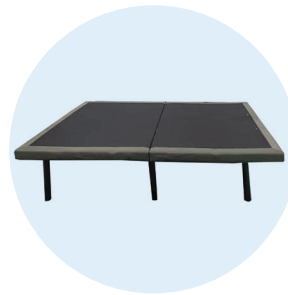
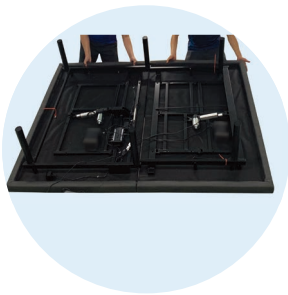

- 7 From under the head and foot sections of the bed, cut and remove the orange zip ties holding the bars.

**NOTES:**

- Cut these zip ties only AFTER the adjustable bed is turned over on its legs or placed on a platform bed with the top side facing up.
- There are two (2) zip ties on each side of the foot section and one (1) zip tie located near the edge of the head section. They are easily accessible for cutting.

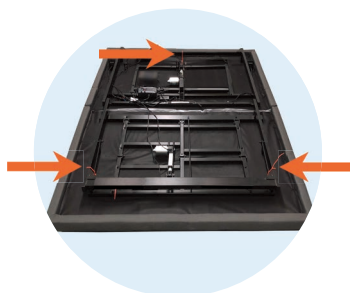

*Zip ties on the head and foot sections of the bed.*

**IMPORTANT!** Make sure power cords do not obstruct any adjustable bed mechanisms.

# Installation guide

---

## Setting up the electronics

- 1 Plug the power cord into a working electrical outlet.

**NOTE:** For optimal safety, using a surge protector (not included) is highly recommended.

- 2 Install batteries in the remote control. Try all functions on the remote to make sure all features are operational.

**NOTE:** If the bed does not work, see the Troubleshooting section of this manual.

- 3 Return bed to flat position before continuing with the installation.

**NOTE:** Make sure your bed is in a flat position before using it. Press and hold the **Flat** button on the remote control for over 1.5 seconds after plugging in the power cord.



## Installing the mattress retainer bracket

- 1 Align both ends of the retainer bracket with the holes located at the foot of the bed.

- 2 Insert the ends into the holes.

If the adjustable bed is set up without a headboard, place your mattress on the adjustable bed surface. Your adjustable bed installation is now complete.

If a headboard is to be installed, see “Assembling the headboard bracket.”



## Using the bed leg strap (optional)

To help prevent base separation when using two adjustable beds together, use the bed leg straps.

- 1 Line up the two beds, then use the bed leg strap to wrap the inside legs together tightly (front leg to front leg and back leg to back leg).

- 2 Fasten the straps to prevent movement & maintain stability.



# Installation guide

## Assembling the headboard bracket (optional)

**NOTE:** Headboard bracket parts are sold separately.

- 1 Turn the adjustable bed over with the top side facing downward.
- 2 Remove the leg from the head section of the adjustable bed by turning the leg in a counter-clockwise direction.
- 3 Slide the inner headboard bracket over the hole for the leg installation. (The bracket opening should face away from the adjustable bed.)
- 4 Screw the leg back in by turning it clockwise. This will secure the inner headboard bracket to the adjustable bed.
- 5 Place the open side of the outer headboard bracket onto the exposed square tube of the inner headboard bracket.
- 6 Insert a retainer bolt fitted with a washer through the outer headboard bracket and into the inner headboard bracket. Tighten the bolt with an Allen key wrench. Leave loose enough for adjusting.
- 7 Repeat steps 2 to 6 to install the brackets on the other side of the head section of the adjustable bed.

**NOTE:** When the headboard brackets are assembled, make sure there is a space of 1.5 inches (38.1mm) to 2 inches (50.8mm) between the edge of the bed and the headboard brackets.

- 8 Turn the adjustable bed over into an upright position. Move the bed and the headboard as close as possible to their final location, then install the headboard.

**NOTE:** If you need to adjust the headboard brackets, unscrew the bolts holding the outer headboard brackets and move the brackets accordingly. Reinstall the bolts and tighten securely.

- 9 Place your mattress on the adjustable bed surface. Your adjustable bed and headboard installation is now complete.



### IMPORTANT!

- Failure to follow the installation steps as they appear in this guide could result in damage to your adjustable bed.
- For safety reasons, lifting of the adjustable bed must always be performed by two (2) people; and the unit should always be on a flat surface.
- Make sure to position the bottom of the headboard cross member no more than 3 inches (76.2mm) between the headboard and the top of the mattress.



# Installation guide

## Applying anti-skid pads for platform bed use

Your adjustable bed is also created for platform or slatpack bed systems. Before installing on a platform or slat pack bed, apply anti-skid pads under the adjustable bed to keep it in place.

- 1 Turn your adjustable bed on its side and then locate the areas near the center brackets and corner brackets of the frame.

**NOTE:** For safety reasons, lifting of the adjustable bed must always be performed by two (2) people.

- 2 Take the anti-skid pads and remove them from the adhesive backer.

**NOTE:** The anti-skid pads are stapled to the back of the adjustable bed. Make sure to remove the pads after taking the bed out of the shipping carton.



The anti-skid pads are stapled to the back of the adjustable bed.

- 3 Apply the anti-skid pads on each of the identified areas near the center and corner brackets as shown.

**IMPORTANT!**

- Make sure to align the anti-skid pads so that they will rest on one of the slats under the adjustable bed. If your bed system is a solid deck surface, there is no need to align the pads to a slat.
- For the areas near the center brackets, you may apply the anti-skid pads to either side of the center bracket. Make sure to align them with the slats.
- A total of 6 anti-skid pads must be applied to the adjustable bed to secure the frame in place and keep it from slipping.

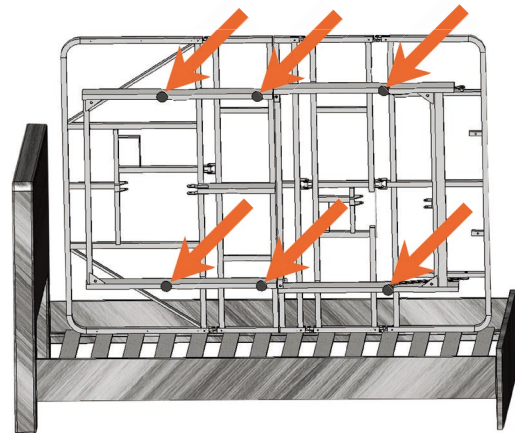

- 4 After applying all the anti-skid pads under the adjustable bed, carefully place the adjustable bed onto the platform or slats.

- 5 To continue setting up the other parts of your adjustable bed, go back to page 8.

**IMPORTANT!** Make sure your platform or slatpack base can support the maximum weight of the adjustable bed (135 lb for Queen beds and 163 lb for King beds) and the mattress.

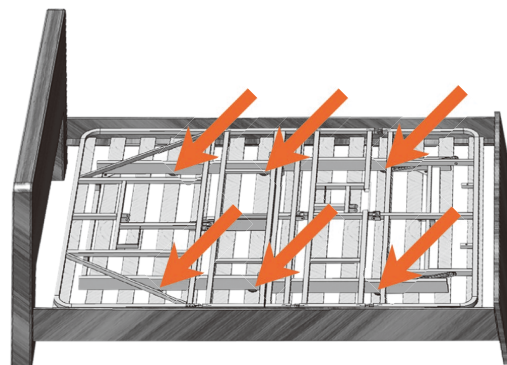



# Remote control guide



---



## HEAD POSITION ADJUSTMENTS (1, 3)

Press the Head Up  or Head Down  button to raise or lower the head section of your adjustable bed.

## FOOT POSITION ADJUSTMENTS (2, 5)

Press the Foot Up  or Foot Down  button to raise or lower the foot section of your adjustable bed.

## FLASHLIGHT (4)

Press this button to turn on the flashlight on your remote control. Release the button to turn it off.

## FLAT (6)

Press this button to return the bed to a flat position.

**NOTE:** Make sure your bed is in a flat position before using it. Press the FLAT button on the remote control after plugging in the power cord.

## ZG OR ZERO GRAVITY (7)

Press this button to elevate the legs slightly higher than the chest, in effect, allowing the blood to flow back to the heart to help reduce stress and fatigue.

# Remote control guide

---

## Understanding the remote control features

- The adjustable bed uses RF (radio frequency) remote control system.
- The buttons are backlit when pressed to aid in the visibility of the remote control in low-light environments.
- It is not necessary to face the receiver when operating the remote control. Remote signal is best transmitted within 6.5 feet (2 meters) of the bed.

**NOTE:** The bed may have minor intermittent performance interruptions because of typical radio frequency interference. This is normal in the operation of the bed, not a defect.

## Customizing the preset button

You can store new head and foot positions by customizing the preset button Zero Gravity. This can be reprogrammed with your desired positions at any time. For safety reasons, the FLAT button cannot be customized.

- 1 Move the head and/or foot sections to your desired position.
- 2 Press and hold the **ZG** button for 5 seconds until the remote backlight flashes.

The new bed position is now stored in your selected preset button overriding the factory default.

To restore the presets to their factory settings, see "Resetting your system".

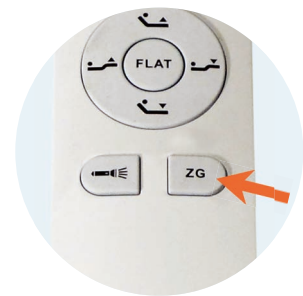

## Pairing your remote control to your adjustable bed

Your adjustable bed is already paired to your remote control at the factory. Manual pairing is only needed for replacement remote controls or to change tandem systems back to a single system.

**NOTE:** For the pairing to be successful, make sure the distance between the control box and the remote control is not more than two (2) meters.

- 1 Unplug the power cord from the electrical outlet. If installed, remove the two (2) 9V alkaline batteries intended for back-up battery power.
- 2 Plug the power cord back to a working electrical outlet (a surge protector is recommended). The LED light on the control box turns blue and the control box is in remote pairing mode for 20 seconds.





Unplug the power cord, then plug it back in.

**Continued on the next page.**



# Remote control guide

## Pairing your remote control to your adjustable bed—continued

- 3 On the remote control, press and hold the **Head Up**  and **Head Down**  buttons at the same time.

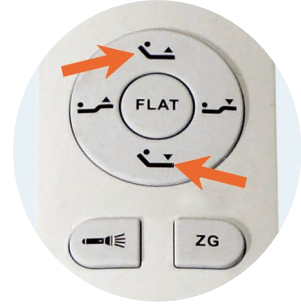

If the pairing is successful, the LED light on the control box turns to green immediately and the remote backlight stops flashing. If pairing fails, the LED light on the control box turns off. Repeat the steps until pairing is successful.



## Syncing two bases to a single remote

**Please keep your other remote in the event that you ever want to split your adjustable base controls to two remotes.**

To operate two adjustable bases together as one bed. Once synced, only one remote can control the bed.

- 1 Plug both Bed A and Bed B to working electrical outlets. A surge protector is recommended.
- 2 Press the **FLAT** button on Remote A and Remote B to align the beds properly in a flat position.
- 3 On the control box on Bed B, unplug the power cord from the outlet and then plug it back in. The LED light on the control box turns blue.
- 4 On Remote A, press and hold the **Foot Up**  and **Foot Down**  buttons at the same time. The remote backlight flashes and starts the sync process. If sync is successful, the LED light on the control box turns to green.

Beds A and B can now be operated at the same time using Remote A.

**NOTE:** When operating beds in tandem, both beds should be plugged into a working electrical outlet.

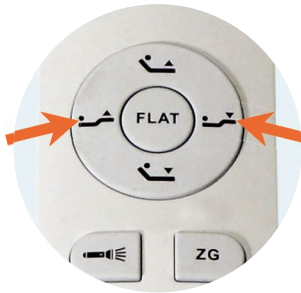

## Remote control guide

---

### Resetting your system

Resetting the system is sometimes necessary to restore any customizations on the preset buttons to its factory settings.

On the remote control, press and hold the **ZG** and **FLAT** button at the same time for 5 seconds until the remote backlight flashes.

All customized settings on the remote control and control box are now cleared or returned to their factory default settings.

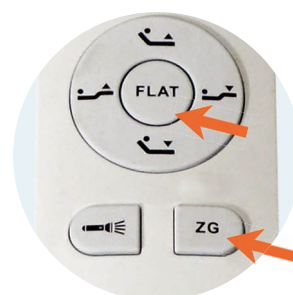

### Special function

---

#### Activating the emergency power down feature

Your adjustable bed supports the emergency power down feature when a power failure occurs while the head and/or foot sections are raised.

**NOTE:** Install the 9V batteries in the power supply unit only during a power failure when the emergency power down function is needed.

- 1 Locate and remove the cover on the 9V battery compartment of your power supply unit.
- 2 Install two (2) alkaline 9V batteries (not included with the adjustable bed). Replace the battery cover.
- 3 When the 9V batteries are installed and a power failure occurs, press the **FLAT** button on the remote control for the bed to return to a flat position.

**NOTE:** The two (2) 9V batteries are for single use only. After lowering the adjustable bed once during a power failure, replace with a new set of batteries.

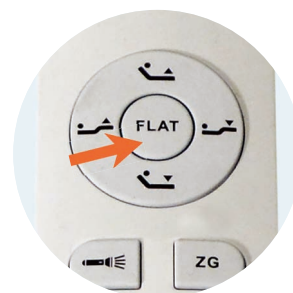

# Troubleshooting

---

In the event the adjustable bed fails to operate, investigate the symptoms and possible solutions below.

## Symptom

## Solutions

**The adjustable bed does not respond when the remote is used. The remote does not work.**

Make sure the remote control is paired with the adjustable bed.

Check that the power cord is plugged into a working electrical outlet. Unplug the power cord from the outlet. After 30 seconds, plug it back in. Press any button on the remote control and check if the bed responds.

Check if the control box is working properly. Make sure the control box is properly connected to the power supply unit by checking if the LED light turns on when the power cord is plugged in.

Check the batteries in the remote control. Replace with new batteries, if necessary.

Make sure batteries are properly installed. Follow the markings on the battery compartment.

Remove batteries. Leave them out for 30 seconds before putting them back into the remote control.

Scratch the terminals inside the remote's battery compartment with a coin or key.

Check that the surge protection device or electrical outlet is not defective. Test the outlet by plugging in another working appliance.

---

**Remote control does not work or light up.**

Check if the remote buttons light up when pressed. If not, replace the batteries.

Remove batteries. Leave them out for 30 seconds before putting them back into the remote control.

Scratch the terminals inside the remote's battery compartment with a coin or key.

Make sure batteries are properly installed. Follow the markings on the battery compartment.

---

**The adjustable bed stutters when in motion.**

Clear any clutter or obstructions under and around the adjustable bed. Radio frequency interference from other remotes or electronic devices may affect normal operation.

Check the batteries in the remote.

Press the lift buttons firmly and accurately.



# Troubleshooting

---

In the event the adjustable bed fails to operate, investigate the symptoms and possible solutions below.

## Symptom

## Solutions

---

**Split or tandem system is out of sync. Only one of the two adjustable bed raises or both beds raise but one side is higher than the other.**

Reset the system and then sync one remote to both adjustable beds again.

---

**Head or foot section elevates adjustable bed but does not return to flat position.**

Your adjustable bed may be obstructed preventing smooth operation. Remove obstructions from around and under the bed.

Check that the head section is not too close to the wall.

If a headboard is installed, check that it is not too close to the edge of the mattress. Make sure there is enough distance between the headboard bracket and the mattress.

---

**Head or foot lift function has minor interference during operation.**

Check the batteries in the remote control. Replace with new batteries, if necessary.

Make sure that you are following the duty cycle of the motors. Do not operate for more than two minutes over a 20-minute period or approximately 10% duty cycle.

Press the lift buttons firmly and accurately.

Wireless remote control may be experiencing common radio frequency interference from other radio transmitting devices. Wait several seconds and then try pressing the lift buttons again.

---

**The adjustable bed is squeaking.**

1. Remove or loosen any pin, nut, bolt, or screw one at a time.
2. Lubricate pins, nuts, bolts, or screws by applying the grease with a cotton swab. Using a lithium or spray lubricant is recommended. (Lubrication can be obtained by contacting our Customer Care Center).
3. When placing the lubricated pin, nut, bolt, or screw back onto the adjustable bed, make sure there is a looser tightening on the nut.
4. Additional solution: After completing these steps, spray the pins, nuts, bolts, and screw with a lubricant.

# Warranty



## Limited Warranty For Adjustable Beds

**LIMITED WARRANTY:** Subject to the terms and conditions set forth herein, the manufacturer of this product, Rize Home, LLC warrants to the original retail purchaser for the time periods stated herein that the adjustable bed system purchased from an authorized reseller of genuine Rize Home, LLC products is merchantable and free of defects and materials and is fit for the purpose of residential, non-hospital bedding. Floor samples are not warranted and are purchased AS IS. This warranty applies only to genuine Rize Home, LLC products, and without limiting the foregoing, does not apply to power cords or other accessories supplied by the seller or other parties.

**1-Year Period for All Labor:** The above warranty will apply for 1 year for labor on the bed frame, all components, parts, including, without limitation, electronics, electrical components, drive motors, WiFi module, power supply and power cords, and massage motors.

**3-Year Period for All Components:** The above warranty will apply for 3 years for the bed frame, all components and parts, including, without limitation, electronics, electrical components, drive motors, WiFi module, power supply and power cords, and massage motors. Labor costs are not covered.

**20-Year Period for Bed Frame:** The above warranty will apply for 20 Years prorated to the bed frame, defined as follows: the metal structure of the adjustable bed system only, and specifically does not include its cover, side rails, decking or legs, or other attachments thereto, such as actuator lift motors, control box, WiFi modules, power supply, power cords, or other electrical or mechanical components. For years 4 through 20, the warranty will be reduced by one-seventeenth (1/17) for each year beyond the third year.

**Start of Warranty Period:** The warranty periods stated above will commence on the date of the first retail purchase of the adjustable bed system from an authorized Rize Home, LLC reseller, provided that proof of purchase and warranty registration occur within the time and in the manner set forth below. In the case of replacement parts provided by Rize Home, LLC, the warranty will apply to the original warranty period and will not extend beyond such period.

**NO OTHER WARRANTY EXPRESS OR IMPLIED:** The foregoing express warranty is the only warranty by Rize Home, LLC and all other express warranties or warranties implied by law or otherwise (including without limitation, any implied warranty of fitness for a particular purpose) are hereby denied and disclaimed to the full extent permitted by applicable law.

**EXCLUSIONS FROM WARRANTY:** Loss, damage, malfunctions or other defects caused in whole or in part by any one or more of the following are not covered by any warranty and neither Rize Home, LLC

nor the seller shall be responsible for them: ordinary wear and tear; damage not directly caused by a defect covered by this express warranty; failure to comply with this user Manual and/or any other user instructions issued by Rize Home, LLC for use and maintenance, including without limitation, weight limits and operation; modifications not performed by Rize Home, LLC; use of any parts, components, or accessories that are not supplied by Rize Home, LLC for the specific product and installed by an authorized Rize Home, LLC service provider; use of the product for purposes or in a manner not expressly intended by Rize Home, LLC as described in this Manual or any other misuse or abuse; storage or use outside of home or other exposure to the elements; dampness; or transportation or other handling by anyone other than Rize Home, LLC.

**EXCLUSIVE LIMITED REMEDY:** The sole and exclusive remedy for any item which fails to meet the express written warranty set forth above shall be, at Rize Home, LLC's option, either repair or replacement of the defective item. Rize Home, LLC may require reasonable evidence of the existence of a defect, and Rize Home, LLC customer service staff will discuss specific requirements with the purchaser based on the defects identified by the purchaser. Replacement parts will be provided at no cost to the purchaser, provided that the defective parts are delivered to Rize Home, LLC, unless Rize Home, LLC instructs otherwise in the claims process (see below). Subject to advance approval by Rize Home, LLC, it will also pay reasonable shipping costs for returns requested by Rize Home, LLC and replacement parts or bedding systems.

**CLAIMS PROCESS:** Prior to contacting Rize Home, LLC, please refer to the Troubleshooting section of this Manual and also ensure that use and maintenance instructions in this Manual have been followed. **The following process must be followed to initiate a warranty claim:** (1) during the applicable warranty period stated above, contact Rize Home, LLC customer service to initiate the claim and provide proof of status as the original retail purchaser from an authorized Rize Home, LLC products reseller and prior timely registration of the product (see PRODUCT REGISTRATION below); (2) identification of suspected defect and compliance with Rize Home, LLC requests for documentation or other evidence of the defect, such as return of parts to Rize Home, LLC, the cost of which will be paid by Rize Home, LLC if the defect is confirmed by it or inspection by an authorized Rize Home, LLC service technician or other person approved in writing for that purpose by Rize Home, LLC; and (3) remedy by Rize Home, LLC as stated herein.

**LIMITATION OF LIABILITY:** In no event shall Rize Home, LLC be liable for incidental or consequential damages of any kind or nature whatsoever caused by or arising out of any product defects, and the sole and exclusive remedy shall be repair or replacement of defective items within warranty to the extent and in the manner provided herein.

*All product names, brands, and trademarks are the property of their respective owners.*

# Registration

---



## Warranty Registration Form

Name: \_\_\_\_\_ Phone: \_\_\_\_\_  
Address: \_\_\_\_\_  
City: \_\_\_\_\_ State: \_\_\_\_\_ Zip code: \_\_\_\_\_  
Email address: \_\_\_\_\_  
Store where purchased: \_\_\_\_\_  
Serial no: \_\_\_\_\_ Invoice no: \_\_\_\_\_ Model no: \_\_\_\_\_

### Survey

Gender:  
 M  F

Age:  
 18-30  31-40  41-50  51-60  61-70  71 & up

Reason for purchasing an adjustable bed:  
 Health  Comfort  Other

How did you find out about our beds?  
 Advertising  A friend  Store  Article  Internet  Other

**Please mail to:**  
Rize Home, LLC Customer Care Center  
31050 Diamond Parkway  
Solon, OH 44139

---

**Customer Care Center Phone #**  
1-800-444-8444

**You can also register your bed  
online at [www.rizehome.com](http://www.rizehome.com).**



If you experience any trouble with your adjustable bed within the warranty period, please consult the troubleshooting guide provided with your bed and online, if applicable.

IF PROBLEMS PERSIST, PLEASE CALL CUSTOMER SERVICE TOLL FREE NUMBER

**800-444-8444**

Please have your receipt ready and available.

*Thank you and enjoy your adjustable bed!*