



Owner's manual

Remedy III

Adjustable bed



SERIAL NUMBER: _____
(Place your serial number here for ready reference)



Table of contents

Safety precautions	4
Parts list	6
Installation guide	7
Remote control guide	13
Special functions	17
Troubleshooting	18
Warranty	21

Model Number: MA004RE03

This product and all our bedding products are covered by one or more of the following issued and pending U.S. patents including Nos. 9706848, 9744088, 8209801, 9795223, 8769739, 8209800, 9706848, 8769739, D663968, and other patents pending.

Photos are for illustration purposes only.

COPYRIGHT © 2023 by Rize Home, LLC.

07.19.2023

Safety precautions

Attention!

IMPORTANT SAFETY INSTRUCTIONS.
PLEASE READ THESE INSTRUCTIONS THOROUGHLY BEFORE USING THIS PRODUCT.

Electrical safety

Always unplug this adjustable bed from the electrical outlet before any cleaning of the bed. To safely disconnect, make sure all controls are in the off position, then remove the plug from the outlet.

Keep cord away from heated surfaces. Keep air openings free of lint, hair and the like. Never operate when air openings are blocked. Never drop or insert any object into any opening. Use only indoors.

Cease use of this adjustable bed and contact the Customer Care Center for repair if: (1) it has a damaged cord or plug, (2) it is not working properly, (3) it has been dropped or damaged, or (4) it has been dropped into water.

Grounding safety

To reduce the risk of electric shock, electrical fire, or faulty operation of this product, your adjustable bed may feature a polarized plug meant to be used only with a grounded electrical outlet. If this plug does not fit into your outlet, contact a qualified electrician to install a properly grounded outlet. Failure to use a properly grounded outlet for this product will compromise this important grounding safety feature. The use of adapters is not recommended unless the outlet is checked by a qualified electrician to ensure the proper grounding of the adapter. NOTE: Unauthorized modifications to this product could void the electrical portion of your warranty.

Warranty warning!

This bed is specifically designed to require no maintenance by you, the user. Any opening or tampering with the control box, motors, or hand controls (with the exception of the battery compartment if equipped) will result in a void of the warranty. Only those authorized may conduct repairs or part replacement on your adjustable bed. Unauthorized modifications to this product could void the electrical portion of your warranty.

In-home use only

This adjustable bed is designed exclusively for in-home use.

HOSPITAL DISCLAIMER: It is NOT designed for hospital use and is NOT designed to meet hospital standards. Do not use this bed with TENT TYPE oxygen therapy equipment or use near explosive gases.

Important safety features

Weight fail safe feature: In the case that an overload of weight is placed on the head or foot mechanism, the control unit will automatically stop all functions. The control unit will automatically resume all functions 30 seconds after excess weight is removed.

The recommended weight limitations for your adjustable bed is up to 850 lbs. on all sizes. For your adjustable bed to structurally support the recommended weight, weight must be distributed evenly across the head and foot sections. The adjustable bed will not and is not intended to support or lift this amount in just the head or foot section. Dependent on the size and/or model of mattress, the available weight limit may be less.

Locking caster feature: This adjustable bed may be equipped with special locking casters. For your safety, these casters will prevent bed movement when all casters are in the locked position. To lock casters, push down the safety latch on the caster. To resume product mobility, lift the safety latch up.

NOTE: If your adjustable bed is positioned on a hard floor surface such as hardwood or tile, it is strongly recommended that rubber caster cups or carpet squares are placed under the casters in addition to locking them in place. Casters will not roll when locked, but may slide on an uncarpeted surface.

User-serviceable parts

This bed is specifically designed to have no maintenance by you, the user. Therefore, you are encouraged not to open any motors, alter the wiring, or adjust, modify or change the structure of the product, as it will void the warranty.

Radio frequency is 2.4 ghz

FCC compliant device complies with part 15 of the FCC Rules. Operation is subject to the following two conditions: (1) This



FOR OPTIMAL SAFETY, YOUR ADJUSTABLE BED SHOULD BE PLUGGED INTO A SURGE PROTECTOR (not supplied with this adjustable bed).

Safety precautions

device may not cause harmful interference, and (2) this device must accept any interference received, including interference that may cause undesired operation.

IMPORTANT NOTE: To comply with the FCC RF exposure compliance requirements, no change to the antenna or the device is permitted. Any change to the antenna or the device could result in the device exceeding the RF exposure requirements and void user's authority to operate the device.

Consumers with pacemakers

It is possible that the (optional) vibrating feature of this adjustable bed may be misinterpreted by some pacemakers as movement and/or exercise. This is common with any product that produces a vibrating motion, and may or may not affect your pacemaker. Please consult your physician with any concerns.

Product ratings

Lift Motor Restrictions: The lift motors in this bed are NOT designed to operate continuously for more than two (2) minutes over a twenty (20) minute time period, or approximately 10% duty cycle. To ensure reliable functionality and full life of this product, do not attempt to exceed these limits.

NOTE: Attempting to circumvent or exceed this rating will shorten the life expectancy of the product and may void the warranty.

The structure of the bed will support the recommended weight when distributed evenly across the bed. The head and foot sections are not designed to individually support or lift this amount of weight. For optimal performance, entering and exiting the adjustable bed with the bed in the flat or level position is recommended.

NOTE: Exceeding the recommended weight restrictions could damage your adjustable bed and void your warranty.

Small children and pets warning

Immediately dispose of all packing materials as it can pose a smother risk to small children and pets. Injury could occur also if children or pets are permitted to play on or under the bed. Do not allow children to operate this bed without adult supervision.

Lift warning

Do not sit on the head or foot sections while in the raised position, or during lift or lowering cycles.

Moving after installation

Do not place adjustable bed vertically on its head or foot sections. This may cause injury to persons or damage to the adjustable bed. Two people are required for moving this adjustable bed due to its heavy weight.

Safety

When an overload of weight is placed on the head or foot mechanism, the control unit will automatically stop all functions. The control unit will automatically resume all functions after the excess weight is removed.

Massage motors, if any, will automatically shut off after running continuously for 15 minutes. All massage functions will be operational again after 5 minutes.

NOTICE: The changes or modifications not expressly approved by the party responsible for compliance could void the user's authority to operate the equipment.

Read the Owner's Manual carefully and completely before operating the product. Electric shock may occur if electrical components are not installed or operated according to these guidelines.

SAVE THESE INSTRUCTIONS. Proper operation of your adjustable bed is necessary to ensure the long life and durability you expect from a high-quality product. The manufacturer has tested and inspected this product prior to shipment.

Parts list

Before discarding any packing materials, check the adjustable bed carton and verify all items in the parts list are included.



Remote control (1)



AAA batteries (3)



8" + 3" + 2" legs (6) *

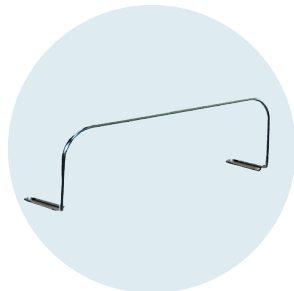

Mattress retainer bar (1)



Anti-skid pads



Bed leg strap (1) **



Sync cable (1) **

* The leg comes assembled as one whole leg with the option of removable leg extenders.

** Only available with Twin XL, Split Cal King, and Split Queen bed sizes.

Installation guide

Setting up your adjustable bed

- 1 Lift the folded adjustable bed out of the box, place it on a flat floor and unfold it.

NOTE: Hold the edge of the bed when unfolding it. Do not hold the metal frames to avoid potential injury.

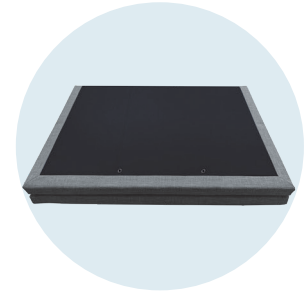

- 2 Remove any accessory boxes from inside the frame. Remove the legs, retainer bracket, and power supply attached to the adjustable bed.

NOTE: Take note of the orange zip ties holding the frame near the head and foot section of the bed. You will cut these ties later in the setup.

If you are installing the adjustable bed on a platform or slatpack bedding system, do not install the legs. Proceed to step 5.



- 3 Attach the bed legs to the adjustable bed by threading them in a clockwise direction into the pre-drilled holes on the frame.

NOTES:

- The legs come assembled as one whole leg with the option of removable leg extenders.
- Tighten the bed legs. After using the bed for a period of time or when the bed shakes unsteadily, check the legs and tighten them again if necessary.

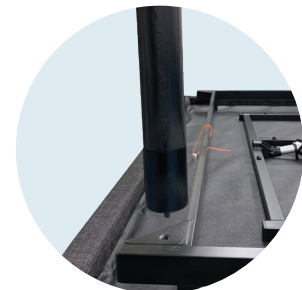

NOTE: For safety reasons, lifting of the adjustable bed must always be performed by two (2) people; and the unit should always be on a flat surface before opening.

Installation guide

- 4 Cut the zip tie holding the LED sensors on both sides of the frame, and then attach the sensors to the legs in the middle of the adjustable bed.

NOTES:

- Make sure to tighten the strap of the LED sensor around the bed leg.
- The sensor light must face outward so it can detect movement and light up when people walk by. It lights up automatically in a dim environment.



- 5 Remove and extend the power cord from the frame.

If you are installing your adjustable bed on a platform or slatpack bedding system, apply anti-skid pads to the frame first. See "Applying anti-skid pads for platform bed use" on page 12.

- 6 Lift one side of the bed and then turn it over carefully so the top side is now facing up.

NOTES:

- Do not lift the bed from the head deck to avoid damage to the adjustable bed.
- When turning the bed over, hold the frame and not the edges of the bed to avoid any damage.
- If you installed bed legs, do not rest the bed on its side so the weight may not damage the legs.



IMPORTANT! Make sure power cords do not obstruct any adjustable bed mechanisms.

Installation guide

- 7 From under the head, lumbar, and foot sections of the bed, cut and remove the orange zip ties holding the bars.

NOTES:

- Cut these zip ties only **AFTER** the adjustable bed is turned over on its legs or placed on a platform bed with the top side facing up.
- There are two (2) zip ties on each side of the foot section, one (1) orange zip tie on the head section, and one (1) zip tie on the lumbar section.

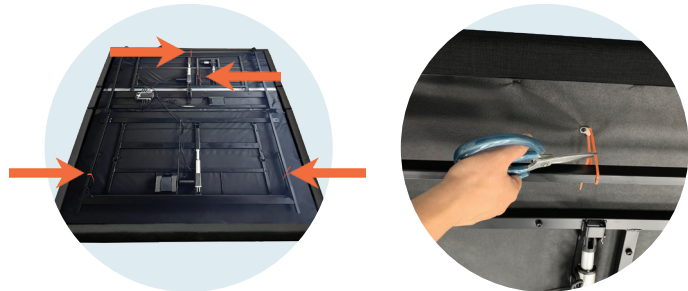

Zip ties on the head, lumbar, and foot sections of the bed.

Setting up the electronics

- 1 Plug the power cord into a working electrical outlet.

NOTE: For optimal safety, using a surge protector (not included) is highly recommended.

- 2 Install batteries in the remote control.

NOTES:

- Make sure your bed is in a flat position before using it. Press the **FLAT** button on the remote control after plugging in the power cord.
- If the bed does not work, see the Troubleshooting section of this manual.

- 3 Try all functions on the remote to make sure all features are operational.

- 4 Return the bed to flat position before continuing with the installation.



IMPORTANT! Make sure power cords do not obstruct any adjustable bed mechanisms.

Installation guide

Installing the mattress retainer bar

- 1 Align the open ends of the retainer bar with the “loop” retainer anchors located at the foot of the bed.
- 2 Slide the retainer bar into the anchors allowing the ends to glide into the loop.

If the adjustable bed is set up without a headboard, place your mattress on the adjustable bed surface. Your adjustable bed installation is now complete.

If a headboard is to be installed, see “Assembling the headboard bracket.”



Using the bed leg strap (optional)

To help prevent bed separation when using two adjustable beds together, use the bed leg straps.

- 1 Line up the two beds, then use the bed leg strap to wrap the inside legs together tightly (front leg to front leg and back leg to back leg).
- 2 Fasten the straps to prevent movement & maintain stability.



Installation guide

Assembling the headboard bracket (optional)

NOTE: Headboard bracket parts are sold separately.

- 1 Turn the adjustable bed over with the top side facing downward.
- 2 Remove the leg from the head section of the adjustable bed by turning the leg in a counter-clockwise direction.
- 3 Slide the inner headboard bracket over the hole for the leg installation. (The bracket opening should face away from the adjustable bed.)
- 4 Screw the leg back in by turning it clockwise. This will secure the inner headboard bracket to the adjustable bed.
- 5 Place the open side of the outer headboard bracket onto the exposed square tube of the inner headboard bracket.
- 6 Insert a retainer bolt fitted with a washer through the outer headboard bracket and into the inner headboard bracket. Tighten the bolt with an Allen key wrench. Leave loose enough for adjusting.
- 7 Repeat steps 2 to 6 to install the brackets on the other side of the head section of the adjustable bed.

NOTE: When the headboard brackets are assembled, make sure there is a space of 1.5 inches (38.1mm) to 2 inches (50.8mm) between the edge of the bed and the headboard brackets.

- 8 Turn the adjustable bed over into an upright position. Move the bed and the headboard as close as possible to their final location, then install the headboard.

NOTE: If you need to adjust the headboard brackets, unscrew the bolts holding the outer headboard brackets and move the brackets accordingly. Reinstall the bolts and tighten securely.

- 9 Place your mattress on the adjustable bed surface. Your adjustable bed and headboard installation is now complete.



IMPORTANT!

- Failure to follow the installation steps as they appear in this guide could result in damage to your adjustable bed.
- For safety reasons, lifting of the adjustable bed must always be performed by two (2) people; and the unit should always be on a flat surface.
- Make sure to position the bottom of the headboard cross member no more than 3 inches (76.2mm) between the headboard and the top of the mattress.

Installation guide

Applying anti-skid pads for platform bed use

Your adjustable bed is also created for platform or slatpack bed systems. Before installing on a platform or slat pack bed, apply anti-skid pads under the adjustable bed to keep it in place.

- 1 Turn your adjustable bed on its side and then locate the areas near the center brackets and corner brackets of the frame.

NOTE: For safety reasons, lifting of the adjustable bed must always be performed by two (2) people.

- 2 Take the anti-skid pads and remove them from the adhesive backer.

NOTE: The anti-skid pads are stapled to the back of the adjustable bed. Make sure to remove the pads after taking the bed out of the shipping carton.



The anti-skid pads are stapled to the back of the adjustable bed.

- 3 Apply the anti-skid pads on each of the identified areas near the center and corner brackets as shown.

IMPORTANT!

- Make sure to align the anti-skid pads so that they will rest on one of the slats under the adjustable bed. If your bed system is a solid deck surface, there is no need to align the pads to a slat.
- For the areas near the center brackets, you may apply the anti-skid pads to either side of the center bracket. Make sure to align them with the slats.
- A total of 6 anti-skid pads must be applied to the adjustable bed to secure the frame in place and keep it from slipping.

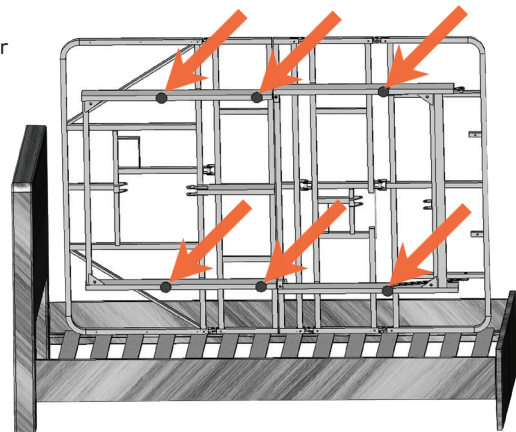

- 4 After applying all the anti-skid pads under the adjustable bed, carefully place the adjustable bed onto the platform or slats.

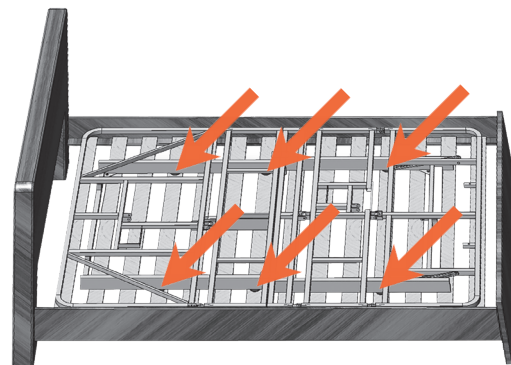

- 5 To continue setting up the other parts of your adjustable bed, go back to page 8.

IMPORTANT!

Make sure your platform or slatpack bed system can support the maximum weight of the adjustable bed (135 lb for Queen beds and 163 lb for King beds) and the mattress.

Remote control guide



Head, Lumbar, and Foot Position Adjustments (5, 6, 7, 16, 17, 18)

Press and hold the up or down button to raise or lower the head, lumbar, and foot sections of your bed.

Bed Position Adjustments (4, 14)

Press and hold the up or down button to raise or lower the elevation or incline of the entire adjustable bed.

NOTE: Elevation function is available only with the elevation kit. Elevation kit is sold separately.

Presets

ANTI-SNORE (1)

Press this button to gently raise the head section and allow easier air intake which can help reduce snoring.

M OR MEMORY (2)

Press this button to move the bed into the position stored in the memory.

LEISURE (3)

Press this button to adjust the bed into a chaise lounge position to remove stress and tension from your lower back.

READING (11)

Press this button to raise the head section to an ideal position for watching TV, reading, or laptop use.

ZG OR ZERO GRAVITY (12)

Press this button to raise the legs slightly higher than the chest allowing blood to flow back to the heart to help reduce stress and fatigue.

FLAT (13)

Press this button to return the bed to a flat position.

NOTE: Make sure your bed is in a flat position before using it. Press the **FLAT** button on the after plugging in the power cord.

Remote control guide

Under-bed Light (15)

Press this button to turn the under-bed lighting on, helping you safely navigate in and out of bed during the night. Press the button again to turn the under-bed light off.

MOTION SENSOR

To turn the motion sensor on, press this button and the **ZG** button for 6 seconds until backlight flashes.

To turn the motion sensor off, press this button and the **Anti Snore** button for 6 seconds until backlight flashes.

Massage

TIMER ON/OFF (9)

Press this button to turn massage on or off and to set the timer for the massage to automatically turn off. Press the button to switch between 10-minute, 20-minute, and 30-minute durations (8).

INTENSITY (10)

Press this button to change the intensity of the massage on the head and foot sections.

Understanding the remote control features

- The adjustable bed uses RF (radio frequency) remote control system.
- The buttons are backlit when pressed to aid in the visibility of the remote control in low-light environments.
- It is not necessary to face the receiver when operating the remote control. Remote signal is best transmitted within 9 feet (3 meters) of the bed.

NOTE: The bed may show minor intermittent performance because of typical radio frequency interference. This is normal in the operation of the bed, not a defect.

Customizing the preset buttons

You can store new head and foot positions by customizing the preset buttons: Anti Snore, M (Memory), Reading, Leisure, and ZG (Zero Gravity). These can be reprogrammed with your desired positions at any time. For safety reasons, the Flat button cannot be customized.

1 Move the head and/or foot sections to your desired position using the head, lumbar, and foot adjustment buttons.

2 Press and hold the **M** or any of the preset button that you want to customize for more than 5 seconds or until the remote backlight flashes.

The new bed position is now stored in your selected preset button overriding the factory default.

To restore the presets to their factory settings, see "Resetting your system".

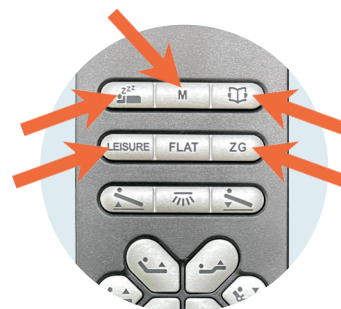



Remote control guide

Pairing the remote control to your adjustable bed

Your adjustable bed is already paired to your remote at the factory. Manual pairing is only needed for replacement remote controls.

NOTE: For the pairing to be successful, make sure the distance between the control box and the remote control is not more than 2 meters.

- 1 Make sure your bed is connected to a working electrical outlet. A surge protector is recommended.
- 2 Unplug the power cord from the electrical outlet. If installed, remove the two (2) 9V alkaline batteries intended for back-up battery power.
- 3 Plug the power cord back to a working electrical outlet (a surge protector is recommended). The LED light on the control box turns blue and the control box is in remote pairing mode for 20 seconds.
- 4 On your remote control, press and hold the **Head Up**  and **Head Down**  buttons until remote backlight flashes.

If the pairing is successful, the LED light on the control box stays on. If pairing fails, the LED light on the control box turns off. Repeat steps 2 to 3 until pairing is successful.

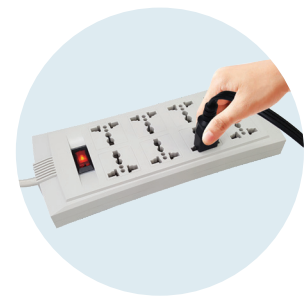

Download the Remote App

Scan the QR code on the left for links to download on the Apple App Store or Google Play.

Remote control guide

Synchronizing two beds for tandem operation

To operate two adjustable beds simultaneously, you must connect both beds using the sync cable.

- 1 Plug both Bed A and Bed B to working and grounded electrical outlets. A surge protector is recommended.
- 2 Before starting the sync process, make sure Bed A and Bed B are in a flat position. Press the **Flat** button on Remote A and Remote B to align the beds properly.
- 3 Plug one end of the sync cable to the control box on Bed A. Insert it into the port labeled "SYNC".
- 4 Plug the other end of the sync cable to the control box on Bed B. Insert it into the port labeled "SYNC".

Beds A and B can now be controlled by both remotes individually.

NOTE: When doing a tandem operation, both Bed A and Bed B should be plugged into working electrical outlets.

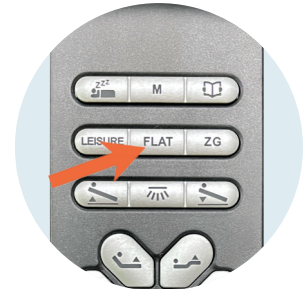

Resetting your system

Resetting the system is sometimes necessary to restore any customizations on the preset buttons to its factory settings.

On the remote control, press and hold the **FLAT** and **ZG** buttons for 5 seconds until the remote backlight flashes.

All customized settings on the remote control are now restored to their default settings.

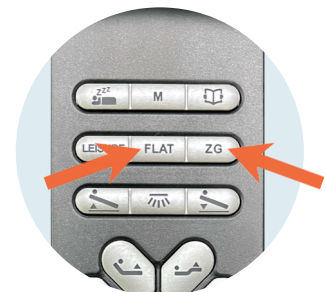

Special functions

Using the mounted USB ports

The convenient USB ports located on the side of the head section of your adjustable bed provide easy access for charging today's tech devices.



Activating the emergency power down feature

Your adjustable bed supports the emergency power down feature when a power failure occurs while the head and/or foot sections are raised.

NOTE: Install the 9V batteries in the power supply unit only during a power failure when the emergency power down function is needed.

- 1 Locate and remove the cover on the 9V battery compartment of your power supply unit.
- 2 Install two (2) alkaline 9V batteries (not included with the adjustable bed). Replace the battery cover.
- 3 When the 9V batteries are installed and a power failure occurs, press the **FLAT** button on the remote control for the bed to return to a flat position.

NOTE: The two (2) 9V batteries are for single use only. After lowering the adjustable bed once during a power failure, replace with a new set of batteries.

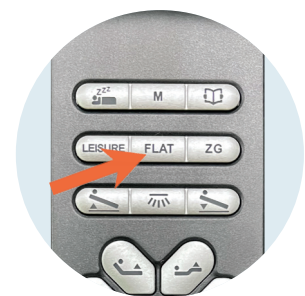

Special functions

Connecting your bed to a smart device

Your adjustable bed can be controlled using your iOS or Android smart device through the **Rize Home** mobile application.

Before connecting your bed to the mobile app, do the following:

- Make sure your adjustable bed is plugged into a working electrical outlet and the control box is on.
- Download and install the **Rize Home** mobile app from the App Store® or the Google Play™ Store.
- For iOS users, turn on your device's Bluetooth®. For Android users, turn on your device's Bluetooth® and Location settings.

- 1 If you are connecting your bed to the mobile app for the first time, enable the mobile device pairing mode on your bed's control box.

Do one of the following:

- Unplug the power cord from the outlet and then plug it back in. The LED light on the control box turns blue. After 20 seconds or after being operated by a paired remote control, the LED light turns green and the control box enters mobile device pairing mode.
- On the control box, press the PAIR button twice. The LED light on the control box turns blue. After 20 seconds, the LED light turns green and the control box enters mobile device pairing mode.

- 2 From your mobile device, launch the app, and then select your adjustable bed model.

- 3 When prompted, connect your bed to your mobile device. From the Add Device screen, select the name of your adjustable bed. The name of your adjustable bed is on the sticker on the front cover of the Owner's Manual and on the control box.

- 4 To change the app screen to Dark Mode, tap the Settings icon, and then select **Screen Settings**.

NOTES:

- If your bed is not on the Devices list, make sure your bed is in mobile device pairing mode. See step 1 for options to enable the mobile device pairing mode on your bed's control box.
- You can only connect one smart device to one adjustable bed at a time.
- The bed is automatically disconnected from the app when you close the app (not running in the background) or move out of range of the connection. Pair the bed to the app again next time you use the app.
- For more information on using the mobile app to control your adjustable bed, see the **Rize Home** app guide.

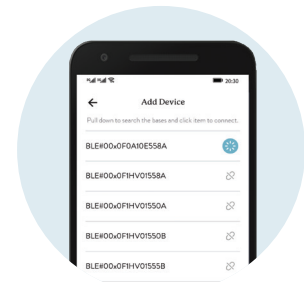
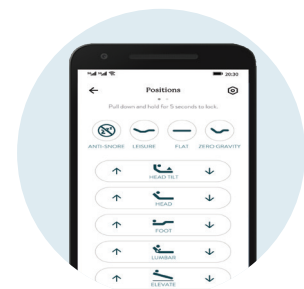

Sample sticker with the name of your adjustable bed

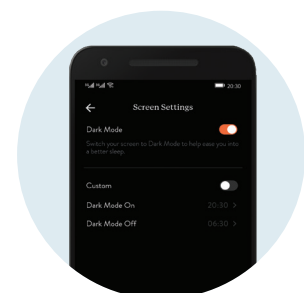

The mobile app in dark mode

Troubleshooting

In the event the adjustable bed fails to operate, investigate the symptoms and possible solutions below.

Symptom

The adjustable bed does not respond when the remote is used. The remote does not work.

No features or functions of the adjustable bed activates.

Solutions

Make sure the remote control is paired with the adjustable bed.

Check that the power cord is plugged into a working electrical outlet. Unplug the power cord from the outlet. After 30 seconds, plug it back in. Press any button on the remote control and check if the bed responds.

Check if the control box is working properly. Make sure the control box is properly connected to the power supply unit by checking if the LED light turns on when the power cord is plugged in.

Check the batteries in the remote control. Replace with new batteries, if necessary.

Make sure batteries are properly installed. Follow the markings on the battery compartment.

Remove batteries. Leave them out for 30 seconds before putting them back into the remote control.

Scratch the terminals inside the remote's battery compartment with a coin or key.

Check that the surge protection device or electrical outlet is not defective. Test the outlet by plugging in another working appliance.

Remote control does not work or light up.

Check if the remote buttons light up when pressed. If not, replace the batteries.

Remove batteries. Leave them out for 30 seconds before putting them back into the remote control.

Scratch the terminals inside the remote's battery compartment with a coin or key.

Make sure batteries are properly installed. Follow the markings on the battery compartment.

Troubleshooting

In the event the adjustable bed fails to operate, investigate the symptoms and possible solutions below.

Symptom

Solutions

Head, lumbar, or foot section elevates the adjustable bed but does not return to flat position.

Your adjustable bed may be obstructed preventing smooth operation. Remove obstructions from around and under the bed.

Check that the head section is not too close to the wall.

If a headboard is installed, check that it is not too close to the edge of the mattress. Make sure there is enough distance between the headboard bracket and the mattress.

Head, lumbar, or foot lift function has minor interference during operation.

Check the batteries in the remote control. Replace with new batteries, if necessary.

Make sure that you are following the duty cycle of the motors. Do not operate for more than two minutes over a 20-minute period or approximately 10% duty cycle.

Press the lift buttons firmly and accurately.

Wireless remote control may be experiencing common radio frequency interference from other radio transmitting devices. Wait several seconds and then try pressing the lift buttons again.

The adjustable bed stutters when in motion.

Clear any clutter or obstructions under and around the adjustable bed. Radio frequency interference from other remotes or electronic devices may affect normal operation.

Check the batteries in the remote.

Press the lift buttons firmly and accurately.

Troubleshooting

In the event the adjustable bed fails to operate, investigate the symptoms and possible solutions below.

Symptom

Solutions

The adjustable bed is squeaking.

1. Remove or loosen any pin, nut, bolt or white bushing one at a time.
2. Lubricate it by applying the grease with a cotton swab. Using a lithium or spray lubricant is recommended. (Lubrication can be obtained by contacting our Customer Care Center).
3. When placing the lubricated pin, nut, bolt, or white bushing back onto the adjustable bed, make sure there is a looser tightening on the nut.
4. Additional solution: After completing these steps, spray the pins, nuts, bolts, and white bushings with a lubricant.

Split or tandem system is out of sync. Only one of the two adjustable bed raises or both beds raise but one side is higher than the other.

Reset the system and then sync both beds again. For more information, see "Synchronizing two beds for tandem operation."

Massage motors seem excessively loud during operation.

Hard surface flooring may cause added vibration. To correct, place carpet pieces or rubber furniture cups under each leg or caster of the bed.

Elevate the head or foot section a short distance (using the remote control) to realign the lift/lower mechanisms with the bed support platform.

Check that the bed is not in direct contact with a wall, nightstand, or other object that may cause vibration or noise.

If the adjustable bed is installed on top of a bed, check that the massage motors are not causing the bed (or bed components) to vibrate or rattle.

Check that the headboard attachment hardware is tightened firmly (if used).

Warranty



Limited Warranty For Adjustable Beds

LIMITED WARRANTY: Subject to the terms and conditions set forth herein, the manufacturer of this product, Rize Home, LLC, warrants to the original retail purchaser for the time periods stated herein that the adjustable bed system purchased from an authorized reseller of genuine Rize Home, LLC products is merchantable and free of defects and materials and is fit for the purpose of residential, non-hospital bedding. Floor samples are not warranted and are purchased AS IS. This warranty applies only to genuine Rize Home, LLC products, and without limiting the foregoing, does not apply to power cords or other accessories supplied by the seller or other parties.

5-Year Period for All Labor: The above warranty will apply for 5 years for labor on the bed frame, all components, parts, including, without limitation, electronics, electrical components, drive motors, WiFi module, power supply and power cords, and massage motors.

5-Year Period for All Components: The above warranty will apply for 5 years for the bed frame, all components and parts, including, without limitation, electronics, electrical components, drive motors, WiFi module, power supply and power cords, and massage motors.

20-Year Period for Bed Frame: The above warranty will apply for 20 Years prorated to the bed frame, defined as follows: the metal structure of the adjustable bed system only, and specifically does not include its cover, side rails, decking or legs, or other attachments thereto, such as actuator lift motors, control box, WiFi modules, power supply, power cords, control box or other electrical or mechanical components. For years 6 through 20 the warranty will be reduced by one-fifteenth (1/15) for each year beyond the fifth year.

Start of Warranty Period: The warranty periods stated above will commence on the date of the first retail purchase of the adjustable bed system from an authorized Rize Home, LLC reseller, provided that proof of purchase and warranty registration occur within the time and in the manner set forth below. In the case of replacement parts provided by Rize Home, LLC, the warranty will apply to the original warranty period and will not extend beyond such period.

NO OTHER WARRANTY EXPRESS OR IMPLIED: The foregoing express warranty is the only warranty by Rize Home, LLC and all other express warranties or warranties implied by law or otherwise (including without limitation, any implied warranty of fitness for a particular purpose) are hereby denied and disclaimed to the full extent permitted by applicable law.

EXCLUSIONS FROM WARRANTY: Loss, damage, malfunctions or other defects caused in whole or in part by any one or more of the following are not covered by any warranty and neither Rize Home, LLC nor the seller shall be responsible for them: ordinary wear and tear; damage not directly caused by a defect covered by this express warranty; failure to comply with this user Manual and/or any other user instructions issued by Rize Home, LLC for use and maintenance, including without limitation, weight limits and operation; modifications not performed by Rize Home, LLC; use of any parts, components, or accessories that are not supplied by Rize Home, LLC for the specific product and installed by an authorized Rize Home, LLC service provider; use of the product for purposes or in a manner not expressly intended by Rize Home, LLC as described in this Manual or any other misuse or abuse; storage or use outside of home or other exposure to the elements; dampness; or transportation or other handling by anyone other than Rize Home, LLC.

EXCLUSIVE LIMITED REMEDY: The sole and exclusive remedy for any item which fails to meet the express written warranty set forth above shall be, at Rize Home, LLC's option, either repair or replacement of the defective item. Rize Home, LLC may require reasonable evidence of the existence of a defect, and Rize Home, LLC customer service staff will discuss specific requirements with the purchaser based on the defects identified by the purchaser. Replacement parts will be provided at no cost to the purchaser, provided that the defective parts are delivered to Rize Home, LLC, unless Rize Home, LLC instructs otherwise in the claims process (see below). Subject to advance approval by Rize Home, LLC, it will also pay reasonable shipping costs for returns requested by Rize Home, LLC and replacement parts or bedding systems.

Registration



Warranty Registration Form

Name: _____ Phone: _____
Address: _____
City: _____ State: _____ Zip code: _____
Email address: _____
Store where purchased: _____
Serial no: _____ Invoice no: _____ Model no: _____

Survey

Gender:

M F

Age:

18-30 31-40 41-50 51-60 61-70 71 & up

Reason for purchasing an adjustable bed:

Health Comfort Other

How did you find out about our beds?

Advertising A friend Store Article Internet Other

Please mail to:

Rize Home, LLC Customer Care Center
31050 Diamond Parkway
Solon, OH 44139

Customer Care Center Phone

1-800-444-8444

*You can also register your bed
online at www.rizehome.com.*

CLAIMS PROCESS: Prior to contacting Rize Home, LLC, please refer to the TROUBLESHOOTING section of this Manual and also ensure that use and maintenance instructions in this Manual have been followed. **The following process must be followed to initiate a warranty claim:** (1) during the applicable warranty period stated above, contact Rize Home, LLC customer service to initiate the claim and provide proof of status as the original retail purchaser from an authorized Rize Home, LLC products reseller and prior timely registration of the product (see PRODUCT REGISTRATION below); (2) identification of suspected defect and compliance with Rize Home, LLC requests for documentation or other evidence of the defect, such as return of parts to Rize Home, LLC, the cost of which will be paid by Rize Home, LLC if the defect is confirmed by it or inspection by an authorized Rize Home, LLC service technician or other person approved in writing for that

purpose by Rize Home, LLC; and (3) remedy by Rize Home, LLC as stated herein.

LIMITATION OF LIABILITY: In no event shall Rize Home, LLC be liable for incidental or consequential damages of any kind or nature whatsoever caused by or arising out of any product defects, and the sole and exclusive remedy shall be repair or replacement of defective items within warranty to the extent and in the manner provided herein.

All product names, brands, and trademarks are the property of their respective owners.



If you experience any trouble with your adjustable bed within the warranty period, please consult the troubleshooting guide provided with your bed and online, if applicable.

IF PROBLEMS PERSIST, PLEASE CALL CUSTOMER SERVICE TOLL FREE NUMBER

1-800-444-8444

Please have your receipt ready and available.

Thank you and enjoy your adjustable bed!