

FREESTYLE



*Comfort*Base®

Owner's Manual



Contents

Safety Information	2
What Is Included	5
Assembly - Base	6
Location of Controls - Remote	13
Operation - Main.....	14
Troubleshooting	16
Specifications.....	17
Technical Assistance	17
Service Requirements	17
Warranty	18
Registration.....	19

User Info

Please take a moment and write down the serial number in the space provided below, in case you need to refer to it in the future. This information can be found by raising the head section of the bed.

SKU: CB00

Serial Number _____

This number will be required for future service claims.

SAFETY INFORMATION

ATTENTION!

**IMPORTANT SAFETY INSTRUCTIONS. SAVE THIS MANUAL!
PLEASE READ THESE INSTRUCTIONS THOROUGHLY BEFORE USING
THIS PRODUCT. PROPER OPERATION OF YOUR ADJUSTABLE BED IS
NECESSARY TO ENSURE THE LONG LIFE AND DURABILITY YOU
EXPECT FROM A HIGH-QUALITY PRODUCT. THE MANUFACTURER
HAS TESTED AND INSPECTED THIS PRODUCT PRIOR TO SHIPMENT.**

RADIO FREQUENCY IS 2.4 GHZ.

FCC compliance device complies with part 15 of the FCC Rules.

Operation is subject to the following two conditions:

- (1) This device may not cause interference, and
- (2) This device must accept any interference received, including interference that may cause undesired operation of the device.

Any change to the antenna or the device could result in the device exceeding the RF exposure requirements and void the user's right to operate the device.

The input voltage is AC100-240 50/60HZ; the output voltage is DC29V 1.8A (Twin, Twin XL, Split Cal King, Full) or DC29V 3A (Queen).

ELECTRICAL SAFETY

Always unplug this adjustable bed from the electrical outlet before any cleaning or maintenance of the adjustable bed. To safely disconnect, remove the plug from the outlet. Keep cord away from heated surfaces. Use only indoors.

WARNING: TO PREVENT FIRE OR SHOCK HAZARD, DO NOT EXPOSE THIS UNIT TO MOISTURE.

Discontinue use of this adjustable bed and contact the manufacturer for repair if:

- (1) it has a damaged cord or plug, (2) it is not working properly, or (3) it has been dropped or damaged.

FOR OPTIMAL SAFETY, YOUR ADJUSTABLE BED SHOULD BE PLUGGED INTO A SURGE PROTECTOR (not supplied with this adjustable bed).

BATTERY PRECAUTIONS

Follow these precautions when using batteries in this device:

1. Warning – Danger of explosion if battery is incorrectly replaced. Replace only with the 6LR61 9V batteries.
2. Be sure to follow the correct polarity when installing the batteries as indicated in the battery compartment. A reversed battery may cause damage to the device.
3. Do not mix different types of batteries together (e.g. Alkaline, Rechargeable and Carbon-zinc) or old batteries with fresh ones.
4. If the device is not to be used for a long period of time, remove the batteries to prevent damage or injury from possible battery leakage.
5. Do not try to recharge a battery not intended to be recharged; it can overheat and rupture. (Follow battery manufacturer's directions.)

SAFETY INFORMATION

WARRANTY WARNING!

This bed is specifically designed to require no maintenance by you, the user. Any opening or tampering with the control box, motors or hand controls (with the exception of the battery compartment, if equipped) will void the warranty. Do not attempt to alter component wiring or adjust or modify the structure of the product in any way or the warranty will be void. Only those authorized may conduct repairs or part replacement on your adjustable bed.

IN-HOME USE ONLY

This adjustable bed is designed exclusively for in-home use.

HOSPITAL/MEDICAL DISCLAIMER: This base is NOT designed for hospital or medical use (In-Home or Commercial) and is NOT designed to meet medical or hospital standards. Do not use this base with TENT TYPE oxygen therapy equipment or use near explosive gases.

PRODUCT RATINGS

Lift Motor Restrictions: The lift motors in this bed are NOT designed to operate continuously for more than one (1) minute over an eight (8) minute time period, or approximately 12% duty cycle. To ensure reliable functionality and full life of this product, do not attempt to exceed these limits.

NOTE: Attempting to circumvent or exceed this rating will shorten the product life expectancy or cause damage to the product and may void the warranty.

Weight Restrictions: The recommended weight limits on our adjustable beds are:

Queen: 650 lb Full: 500 lb Twin, Twin XL, Split Cal King: 400 lb (800lb if using two Twin XL/Split Cal Kings for one King/Cal King base)

The structure of the bed will support the recommended weight when distributed evenly across the bed.

The head and foot sections are not designed to individually support or lift this amount of weight.

For optimal performance and integrity of structure, entering and exiting the adjustable bed with the bed in the flat position is recommended.

NOTES:

- Exceeding the recommended weight restrictions could damage your adjustable bed and void your warranty.
- Due to flexibility in Box Spring mattress supports, TXL and SCK models are not intended to be connected together for use on Box Spring mattress supports.

SAFETY INFORMATION

SMALL CHILDREN AND PETS WARNING

Immediately dispose of all packing materials as they can pose a smothering risk to small children and pets. Injury could also occur if children or pets are permitted to play on or under the bed. Do not allow children to operate this bed without adult supervision.

LUBRICATION AND CLEANING

This product is designed to be maintenance-free. The lift motors are permanently lubricated and sealed — no additional lubrication is required. Do not apply lubricant to lift motor or base components (nuts, bolts, etc.).

LIFT WARNING

DO NOT SIT ON THE HEAD OR FOOT SECTIONS WHILE IN THE RAISED POSITION, OR DURING LIFT OR LOWERING CYCLES.

MOVING AFTER INSTALLATION

Do not place adjustable bed base vertically on its head or foot sections. This may cause injury to persons or damage to base.









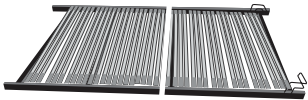

WARNING!

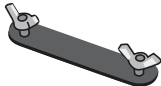
To reduce the risk of burns, fire, electric shock, or injury to persons:

- Unplug from outlet before putting on or taking off accessories.
- Close supervision is necessary when this base is used by, or near children, invalids, disabled persons, or pets.
- Use this base only for its intended use as described in these instructions. Do not use attachments not recommended by the manufacturer.
- Never operate this base if it has a damaged cord or plug, is not working properly, has been dropped or damaged, or dropped in water.
- Keep the cord away from heated surfaces.
- Never drop or insert any object into any opening.
- Do not use outdoors.
- Do not operate where aerosol (spray) products are being used or where oxygen is being administered.
- To disconnect, remove plug from outlet.
- **DO NOT USE NEAR PEOPLE USING OR WEARING MEDICAL DEVICES. FOR HOUSEHOLD/RESIDENTIAL USE ONLY.**
- Do not exceed recommended duty cycle, reference page 3.

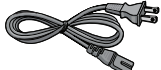
WHAT IS INCLUDED

Before discarding any packing materials, check the adjustable base shipping carton and verify the following items are included:

	(2) Base Pieces
	(2) Connecting Rods
	(8) Hex Bolts (Pre-installed on Connecting Rods) (1) Allen Key
	(1) Connector Plate with Wing Nuts (Twin XL/Split Cal King Only)
	(2) Foot Mattress Retainers with (8) bolts and (1) Allen Key
	(4) Brackets with Wing Nuts (1) Bolt and Retainer Pin
	(1) Remote Control
	(1) AC Cord
	(1) Power Supply
	(1) DC Power Cord
	(1) Sync Cable (For TXL/Split Cal King size only)
	Also included: (2) 9V Batteries , (1) Owner's Manual, (3) AAA Batteries

ASSEMBLY - BASE

It is HIGHLY recommended to use two people for the installation of this product. To assemble, please perform the following steps:

- 1 Carefully lift both Base Pieces and remove the plastic wrapping from the bottom to access the bases. Remove the cable ties holding both Base Pieces together. Lay the two Base Pieces down and unpack the remaining items.

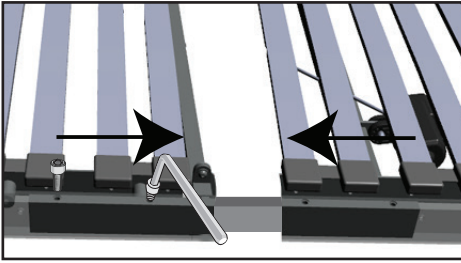

- 2 Remove the bolts from the Connecting Rods and set aside. Insert the Connecting Rods into one side of each Base Piece and install two bolts into each of the Connecting Rods.

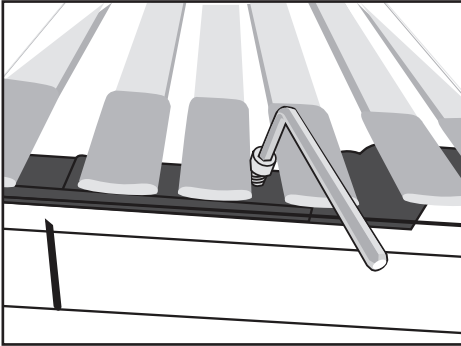

- 3 Slide the other Base Piece over exposed Connecting Rods. Install remaining bolts. Be sure to hand tighten each and then tighten 1/4 turn more, as over-tightening could cause damage to the frame or Connecting Rod.

TWIN XL/KING INSTALLATION:

See pages 7 and 8.

QUEEN INSTALLATION:

See pages 9 and 10.

ASSEMBLY - BASE

TWIN/TWIN XL/FULL/SPLIT CAL KING

STEP 4

A Cut the cable ties securing foot motor cables. Place the unit on its side making sure it is secure. Route cable between slat and metal frame as shown. Improper placement of cable can cause damage to the cable. Secure the cable in plastic clip on the bar.

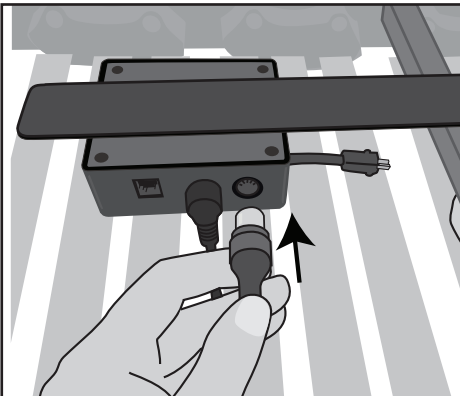
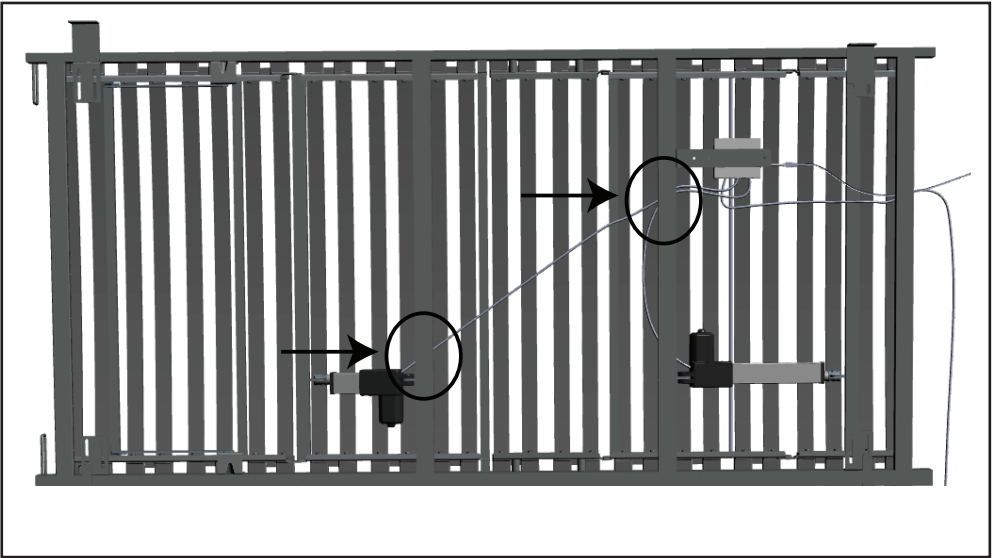

B Connect the Foot motor connector to the Foot motor port on the control box as shown.

ASSEMBLY - BASE

TWIN/TWIN XL/FULL/SPLIT CAL KING

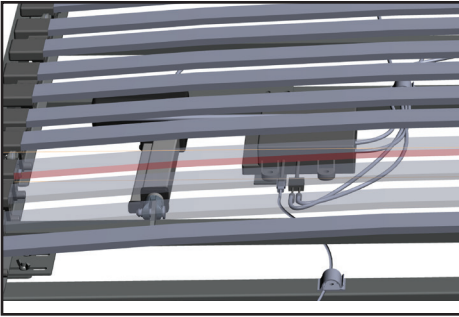

C Route the DC power cord to the control box, snapping the cord into the clip at the head of the bed as shown. Place Base on foundation or platform bed.

If connecting two bases to form a king, repeat steps 1 to 4 for the second Twin XL base, then continue to step 5.

CONNECTING TWO TWIN XL OR SPLIT CAL KING BASES TO FORM A KING OR CAL KING:

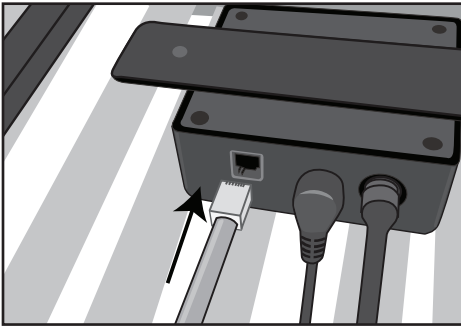

D Lift the head section of each base. Connect the sync cable to the control box to one base. Route the sync cable and snap into clip with power cord (as shown). Connect the other end of sync cable to second control box of other base making sure to route the sync cable thru the clip on second base (as shown).

Continue with step 5 on page 11.

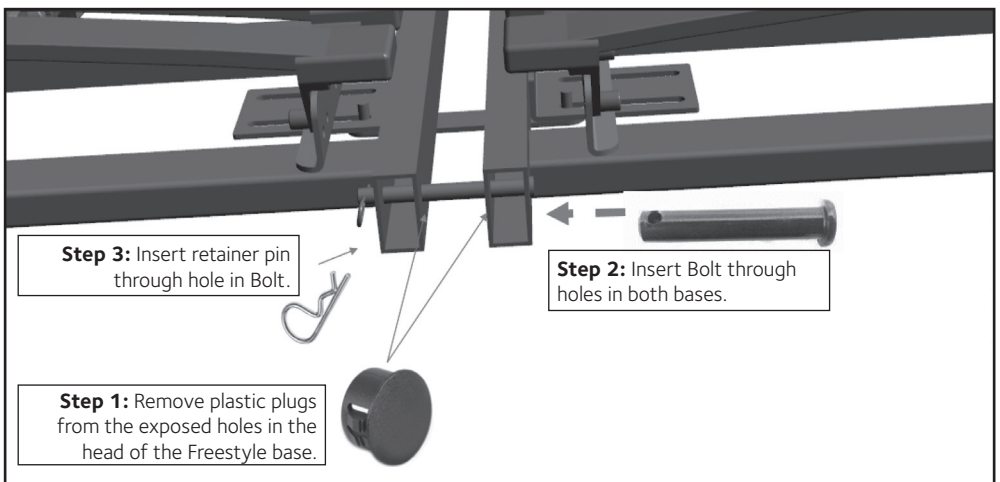

ASSEMBLY - BASE

QUEEN ONLY

STEP 4

A QUEEN: Cut the cable ties securing foot motor cables. Place the unit on its side making sure it is secure. Route foot motor cord between slat and metal frame as shown. Improper placement of cord can cause damage to the cord. Secure the cord in plastic clip on the bar.

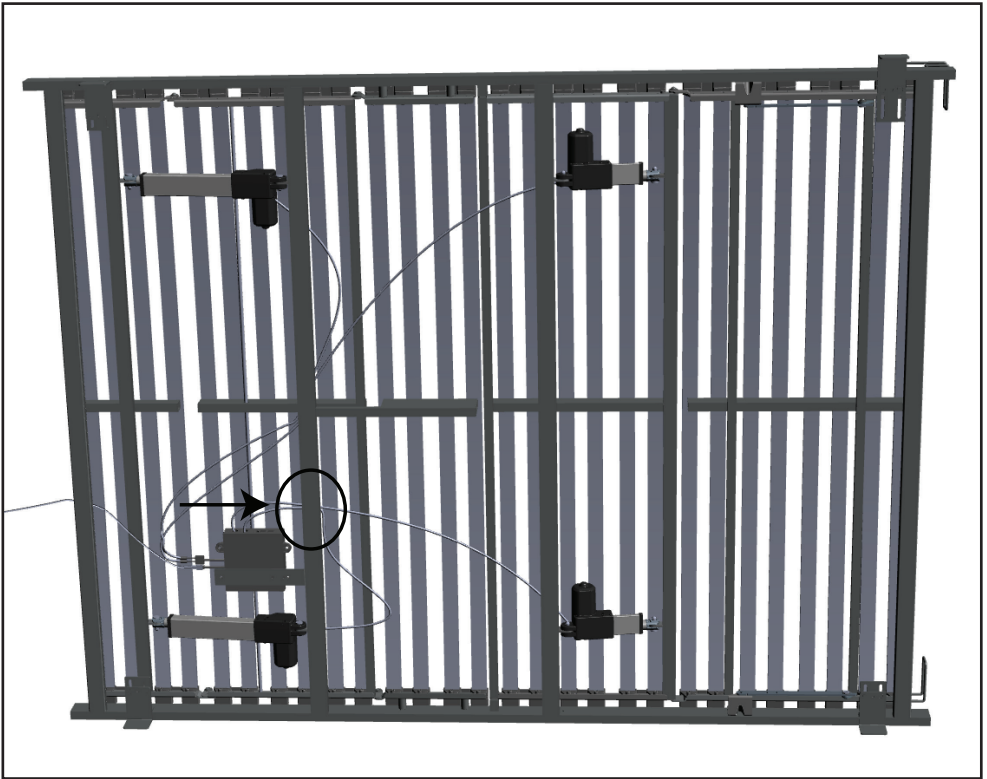

ASSEMBLY - BASE

QUEEN

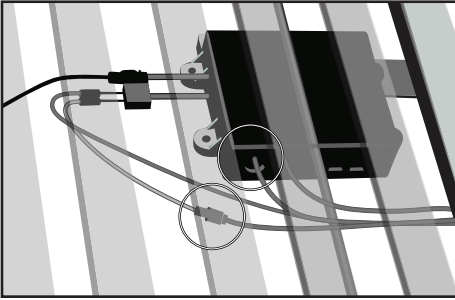

B Connect one foot motor connector to the foot motor port on the control box. Connect the second foot motor cord to the gray cable from the control box.

C Route the DC power cord to the control box, snapping the cord into the clip at the head of the bed as shown. Connect the DC power cord to the control box. Place Base on foundation or platform bed.

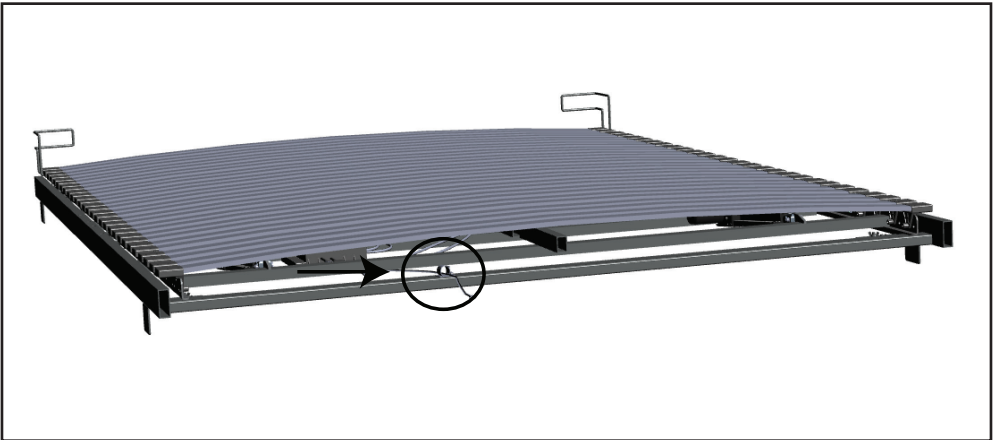

Continue with step 5 on page 11.

ASSEMBLY - BASE

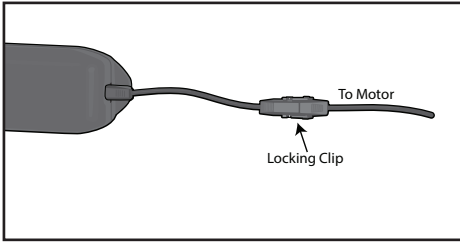

- 5 Insert one end of the DC cord into the power supply. Insert the other end with locking clip into the cable coming from the control box. Lock the connection using the locking clip.

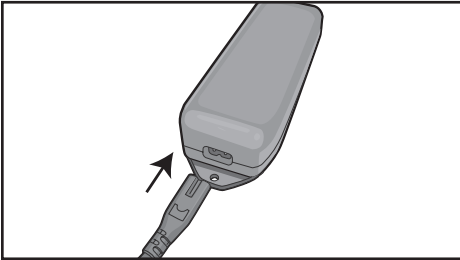

- 6 Insert the AC cord into the power supply.

IMPORTANT: DO NOT PLUG THE BASE INTO THE AC OUTLET YET.

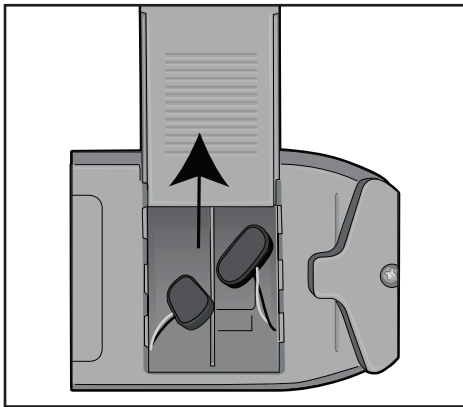

BASE POWER SUPPLY

- 7 Turn the power supply upside down to access the battery cover, then slide the battery cover off.

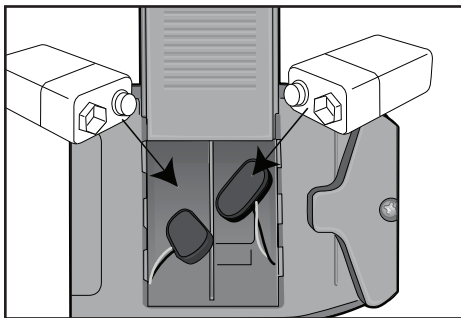

- 8 Insert the two 9V batteries (included) into the compartment and slide the cover back on.

NOTE: The battery backup will allow for the bed to be lowered if a power outage occurs. It is not recommended to do anything except lower the bed as the battery backup will not last if the features are continually used.

ASSEMBLY - BASE

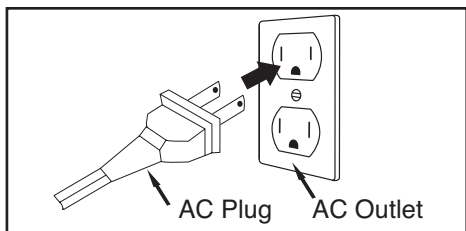

9 Insert the AC plug into an AC outlet having 100-240V AC, 50/60Hz.

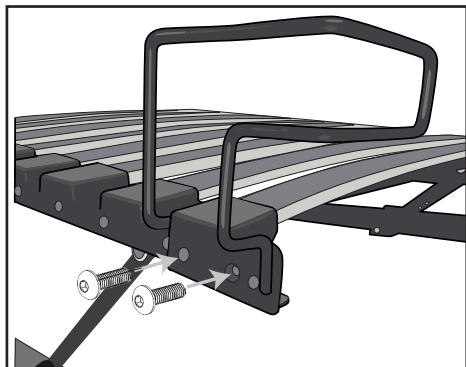

10 Raise Head and Foot Sections fully. Lay Base flat on foundation or platform bed.

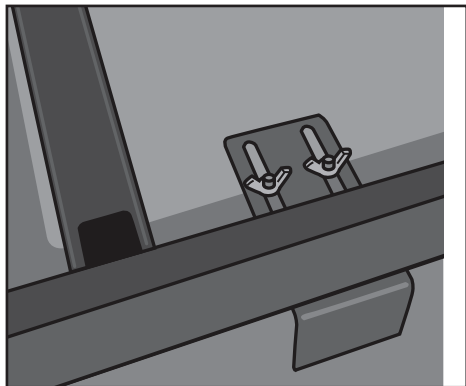

11 Install Mattress Retainer brackets.

NOTE: If connecting (2) Twin XL/Split Cal Kings to form (1) King base only (2) Mattress Retainer Brackets needed on outside corners.

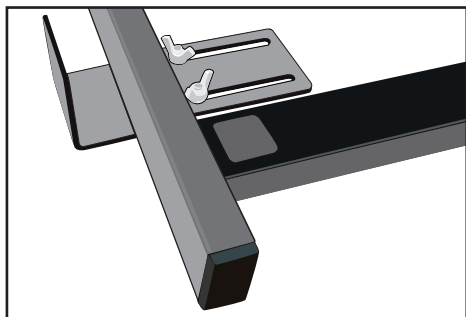

12 Option 1: If installing base on foundation, connect the four Brackets with Wing Nuts to the slotted plates in downward position as shown. Tighten the wing nuts. Make sure Brackets are installed flush with the edge of foundation or box spring.

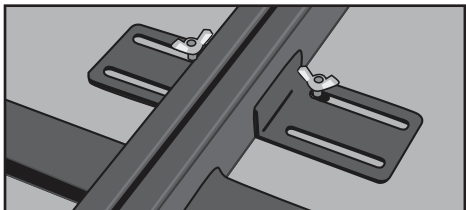

Option 2: If installing base on platform bed, connect the four brackets with wings in upright position as shown.

13 Connect the connector plate with wing nuts as shown in illustration (as shown) to secure bases together. Tighten the wing nuts.

LOCATION OF CONTROLS - REMOTE

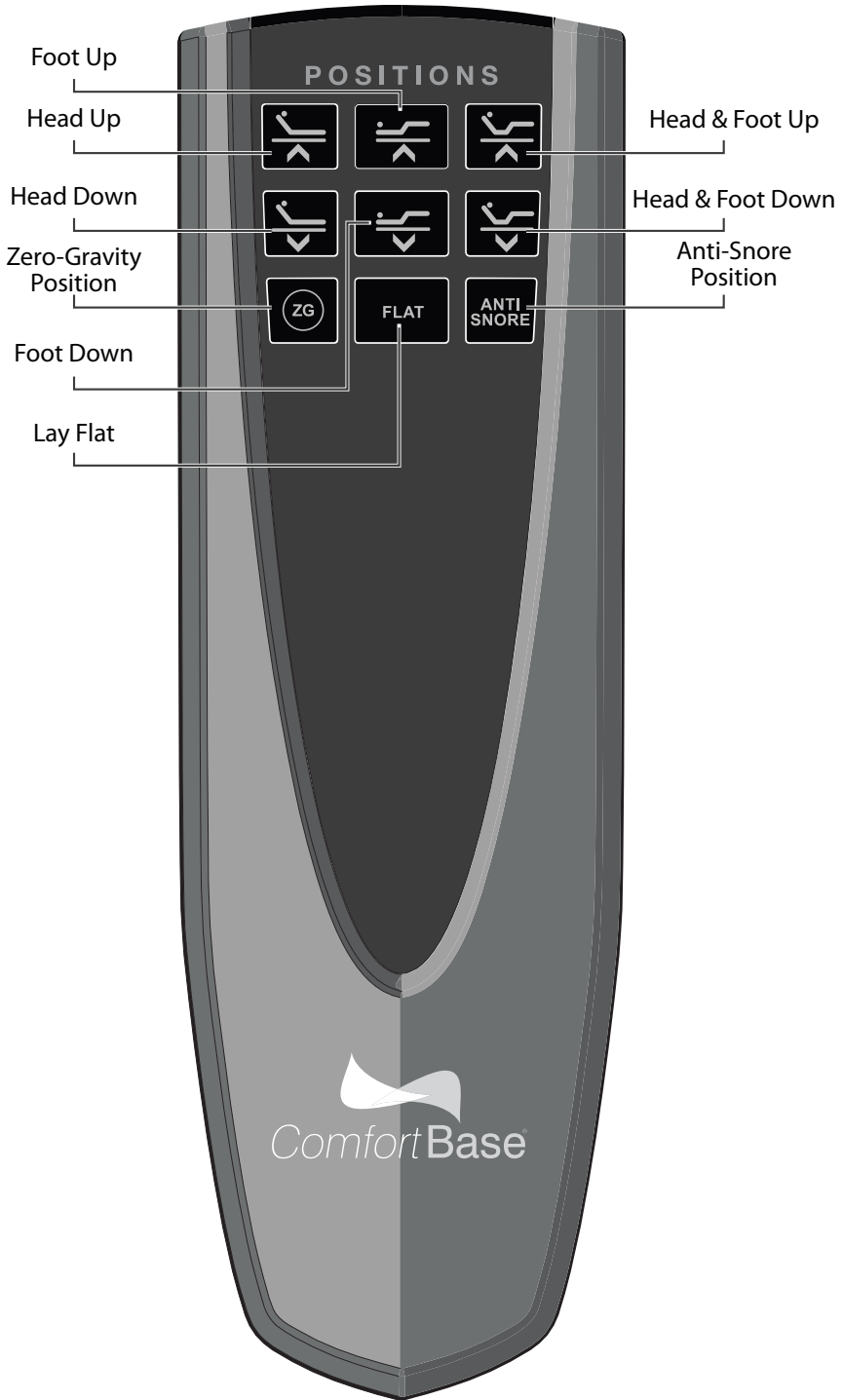

OPERATION - MAIN

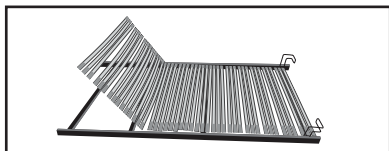

Press and hold the Head Up () button to raise the Head position. Release button when desired position is reached.

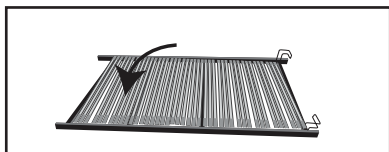

Press and hold the Head Down () button to lower the Head position. Release button when desired position is reached.

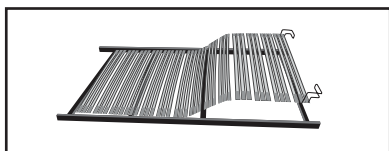

Press and hold the Foot Up () button to raise the Foot position. Release button when desired position is reached.

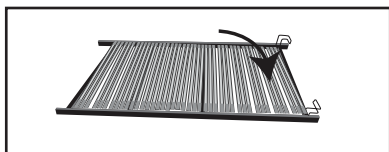

Press and hold the Foot Down () button to lower the Foot position. Release button when desired position is reached.



Press and hold the Head & Foot Up () button to raise both the Head and Foot positions. Release button when desired position is reached.

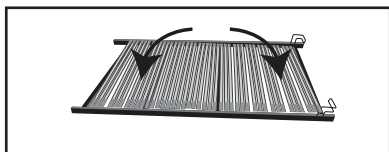

Press and hold the Head & Foot Down () button to lower both the Head and Foot positions. Release button when desired position is reached.





Press the Zero Gravity () button and the Head/Foot positions will go to the Zero Gravity position. This action can be stopped at any time by pressing another button.

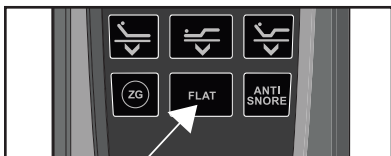

Press the ANTI-SNORE () button and the Head position will go to the Anti-Snore position. This action can be stopped at any time by pressing another button.

OPERATION - MAIN



Press the FLAT () button and the bed will level. This action can be stopped at any time by pressing another button.



NOTE: EMERGENCY LOWERING: If you cannot find the remote control to lower base, locate and press the red Emergency Lowering button located on the main control box (shown to the left).

TROUBLESHOOTING

In the event the Comfort Base's base fails to operate, investigate the symptoms and possible solutions provided below:

<p>Remote control illuminates and appears to be operable, but no features of the base will activate.</p>	<ul style="list-style-type: none"> • Unplug power cord, wait 30 seconds and plug in to reset electronic components. • Defective surge protection device or electrical outlet. Test outlet by plugging in another working appliance. • Electrical circuit breaker may be tripped. Check electrical service breaker box to verify. • Re-link the remote control (see Remote Control Re-Linking section on this page for programming procedures).
<p>Remote control will not illuminate.</p>	<ul style="list-style-type: none"> • Replace batteries in the remote control.
<p>Head or foot section will raise, but will not return to the horizontal (flat) position.</p>	<ul style="list-style-type: none"> • Base mechanism may be obstructed. Raise base and check for obstruction. Remove obstruction.
<p>Head or Foot Lift Function has minor interference during operation.</p>	<ul style="list-style-type: none"> • Check batteries in remote, replace if necessary. • Make sure that you are following the duty cycle of the motor (do not operate more than one (1) minute over an eight (8) minute period, or approximately a 12% duty cycle). • Press the lift buttons squarely and accurately. • Control box may be experiencing common Radio Frequency Interference from other radio transmitting devices (see Remote Control Re-Linking section below).
<p>Zero-Gravity button needs to be re-programmed back to factory settings.</p>	<ul style="list-style-type: none"> • The Zero-Gravity button is a pre-set position button on your remote. This button has the ability to be re-programmed to a different position. To change the setting follow the above instructions on programming the memory buttons. If you would like to re-set the button back to the original factory settings follow the below instructions. • (1) Raise Head to 17 degrees. (2) Raise Foot to 25 degrees. (3) At the same time, press and hold both DOWN buttons for head and foot until the remote starts to flash. (4) Release these buttons. (5) Press Zero Gravity button once. (6) Done.
<p>REMOTE CONTROL RE-LINKING AND TROUBLESHOOTING</p> <p>The remote is causing interference with appliances, TV, garage door opener, another base in a different room, etc.</p>	<ul style="list-style-type: none"> • Lift the battery cover on remote and remove the yellow sticker to expose the DIP switches. Slide the switches to positions different from the other remotes in the house. Make sure that all switches are not in the up position or in the down position. They must vary in position. • Press and hold the Link button on the bottom of the base until the base's LED turns on and then off. Release the button and the LED will blink. • Simultaneously press and hold the Head Up and Foot Up buttons (top left and top middle buttons on the remote) until the remote's back-light starts blinking. Release the two buttons, the back-light and the base's LED will blink until linked, then they will turn off. • Test the bed to make sure it is working, and repeat steps if it is not.

SPECIFICATIONS

Weight Capacity Queen: 650 lb, Full: 500lb, Twin, Twin XL, Split Cal King: 400 lb
Power Input AC100-240 50/60HZ
Power Transformer Output..... Full, Queen: DC29V 3A,
..... Twin, Twin XL, Split Cal King DC29V 1.8A
Radio Frequency 2.4GHz
Incline..... Head: 70°, Feet: 30°
Overall Height 3"
Included Parts..... (2) Base Pieces, (2) Foot Mattress Retainer, (2) Connecting Rods,
..... (1) Connector Plate with Wing Nuts (Twin XL/Split Cal King only),
.....(4) Brackets with Wing Nuts, (8) Hex Bolts (Pre-installed), (1) Allen Key,
.....(1) Remote Control, (1) Sync Cable (for TXL/Split Cal King size only),
..... (1) Power Supply, AC and DC Power Cords,
.....(2) 9V Battery for Battery Backup, (3) AAA Batteries, (1) Manual

TECHNICAL ASSISTANCE

For any questions, claims, or technical assistance, please contact Glideaway at 1-855-581-3095 or comfortbase@glideaway.com.

SERVICE REQUIREMENTS

Service technicians are not responsible for moving furniture, removing headboards and foot boards, or any items required to perform maintenance on your adjustable bed. In the event the technician is unable to perform service due to lack of accessibility, the service call may be billed to the purchaser and the service will be re-scheduled.

WARRANTY

Glideaway Standard Comfort Base® Fifteen Year Limited Warranty 1821.A

Glideaway Sleep Products ("Glideaway") warrants to the original consumer purchaser that the motorized bed frame, motorized bed foundation and adjustable bed (hereinafter referred to as "adjustable bed" or "adjustable beds") are free from defects in workmanship and material as provided herein. To the extent permitted by law, this Limited Warranty is not transferable and coverage terminates if the original consumer purchaser ("purchaser") sells or otherwise transfers the product.

If you wish to make a claim

You must contact the Glideaway dealer from whom the product was purchased, or if not available, Glideaway 1 855 581-3095 within thirty days of discovery of the problem with the serial number and the original sale receipt which identifies the date of purchase. Any information or materials to be returned upon authorization should be sent to Glideaway at 8226 Lackland Road, St. Louis, MO 63114.

What we will do

Years 1 and 2: Full coverage parts and labor warranty This adjustable bed is warranted against defects in the workmanship or materials for a period of up to two (2) years from the date of purchase for adjustable beds bought new and for up to two (2) years from the date of manufacture for those beds that were originally floor samples. Glideaway will send replacement parts (at no cost to the purchaser) for any defective adjustable bed part to the purchaser, and Glideaway will pay all preauthorized labor and transportation costs associated with the repair or replacement of any parts which Glideaway determines to be defective. This two (2) year warranty shall not apply if purchaser does not return any and all defective parts to Glideaway within 15 days of purchaser's receiving of replacement part(s).

Year 3: Full coverage of parts only warranty If the defect occurs in the third year following purchase for adjustable beds bought new and following the date of manufacture for adjustable beds that were originally floor samples, Glideaway will offer replacement parts (upon terms and conditions set forth in this paragraph) for any mechanical adjustable bed part found to be defective or malfunctioning. This limited warranty shall not apply if purchaser does not return any and all defective or malfunctioning parts to Glideaway within 15 days of purchaser's receipt of replacement parts. To the extent permitted by law, the purchaser shall bear all service, transportation, labor, shipping and handling costs related to the delivery and/or replacement of the defective or malfunctioning parts.

Years 4 through 15: Prorated coverage of non-electrical parts only warranty If the defect occurs in the fourth through fifteenth year following purchase for adjustable beds bought new and following the date of manufacture for adjustable beds that were originally floor samples, Glideaway will offer replacement parts (upon terms and conditions set forth below) for any non-electrical part found to be defective or malfunctioning. Electronics, electrical components, massage motors and lift motors are excluded. Purchaser shall pay 1/15th of the then current replacement cost of the defective part multiplied by the number of years the purchaser has owned the adjustable bed for those beds bought new or multiplied by the number of years since the adjustable bed was manufactured for those adjustable beds which were floor samples. Glideaway shall bear the remainder of the cost of the replacement part. This limited warranty shall not apply if purchaser does not return any and all defective parts to Glideaway within 15 days of purchaser's receipt of replacement parts. To the extent permitted by law, the purchaser shall bear all service, transportation, labor, shipping and handling costs related to the delivery and/or replacement of the defective or malfunctioning parts.

This limited warranty does not cover or apply to

This Limited Warranty does not apply: (a) to any damage caused to the adjustable bed by the purchaser; (b) if there has been any unauthorized repair or replacement of the adjustable bed or parts; (c) if the adjustable bed has been mishandled whether in transit or by other means, subjected to physical or electrical abuse or misuse, or otherwise operated in any way inconsistent with the operation and maintenance procedures outlined in the Owner's Manual, this limited warranty, and any other applicable document published or approved by Glideaway; (d) in relation to damage to mattresses, fabric, cables, electrical cords or items supplied by dealers (also known as retailers or resellers); (e) if there has been any unnecessary service calls, including costs for in-home service calls solely for the purpose of educating the purchaser about the adjustable bed and/or for finding an unsatisfactory power connection; (f) if the recommended weight restrictions (Twin/TXL/Split Queen/Split CA King: 400 pounds/ 181 kilograms, Full/FXL: 500 Pounds/ 227 kilograms, Queen: 650 Pounds/ 295 kilograms, King 800 Pounds/ 363 kilograms) and guidelines for proper distribution of weight as stated in the Owner's Manual are not followed; (g) for adjustable beds used in commercial type settings, such as but not limited to dormitories, hotels and rentals.

Additional terms and conditions

No reimbursement will be made to the purchaser for the inconvenience, removal, installation, setup time, lack of use, shipping, or any other costs or expenses not covered by this limited warranty. Glideaway holds no responsibility for in-home service on adjustable beds. Purchaser should contact their dealer for any terms and conditions relating to purchaser's in-home service if any.

Removal of product tag shall void warranty. The product tag has both the model and serial numbers, which serves as a means of identification to establish one's warranty rights. It is attached to the metal substructure visible when one lifts the head of the base.

TO THE EXTENT PERMITTED BY APPLICABLE LAW, THIS LIMITED WARRANTY REPLACES ALL OTHER REPRESENTATIONS, WARRANTIES OR CONDITIONS, WHETHER EXPRESSED, IMPLIED OR LEGAL ARISING FROM STATUTE, COURSE OF DEALING, USAGE OF TRADE OR OTHERWISE INCLUDING ANY IMPLIED WARRANTIES OR CONDITIONS OF MERCHANTABILITY, DURABILITY, QUALITY AND FITNESS FOR A PARTICULAR PURPOSE AND NO ONE IS AUTHORIZED TO ASSUME OR UNDERTAKE FOR GLIDEAWAY OTHER LIABILITY IN CONNECTION WITH THE SALE OF THE PRODUCT. GLIDEAWAY SHALL NOT BE LIABLE FOR ANY DAMAGES, WHETHER DIRECT, INDIRECT OR CONSEQUENTIAL OR ANY OTHER DAMAGES OF WHATEVER KIND, INCLUDING PERSONAL INJURIES OR DAMAGE TO PROPERTY, EXCEPT AS PROVIDED HEREIN.

This warranty is made by Glideaway and is not made by or on behalf of its distributors, retailers or any other party. Some states or provinces do not allow the exclusion or limitation of incidental or consequential damages or the exclusion of implied warranties or the limitation on how long an implied warranty lasts, so the above limitations or exclusions may not apply to you. This warranty gives you specific legal rights, and you may also have other rights which vary from state to state or province to province. To the extent that the provisions of any applicable legislation expressly replace, eliminate, amend, extend, or prohibit any term or terms contained in this warranty, such term or terms shall be accordingly replaced, eliminated, amended or extended, as the case may be, in accordance with such legislation.

REGISTRATION

Thank you for purchasing a Comfort Base!

Register your Comfort Base by completing the form below or registering online at www.glideaway.com.

Warranty Service

Filling out this form will help you obtain more efficient warranty service in case there is a problem with your product.

Confirmation of Ownership

In case of an insurance loss such as fire, flood, or theft, your registration could serve as your proof of purchase.

For Your Safety

Registering your Comfort Base will allow us to contact you in the unlikely event a safety notification is required.

Please mail the form and send with a copy of your proof of purchase to:

Glideaway
Attn: Warranty/Claims Department
8226 Lackland Drive
St. Louis, MO 63114

Customer Info:

First Name: _____

Last Name: _____

Address: _____

City: _____

State: _____ Zip: _____

Email: _____

Phone Number: _____

Date of Birth: _____

Purchase Info:

Date of Purchase: _____ Model Number: _____

Serial Number: _____

Did you buy online? Yes ____ No ____

Name of Retailer You Purchased from: _____

City of Retailer: _____ State of Retailer: _____

Size of Base: _____ Price Paid: _____



ComfortBase®

Owner's Manual



FREESTYLE

SKU: CB00



8226 LACKLAND RD. ST. LOUIS, MO 63114 | 314.426.3999 | WWW.GLIDEAWAY.COM



REV 08.30.18