

# COSMO

## FREESTANDING FIRE TABLE



Freedom, flexibility and eco-friendly functionality – EcoSmart’s freestanding bioethanol fireplaces add warmth, style and ambiance to living and entertaining spaces. Cleverly refashioning the traditional fireplace concept into a piece of portable fire furniture means that you can now enjoy the simple pleasures of an open fire in more places than ever before.

**Relocate With Ease**

Bioethanol outdoor fireplaces relocate with ease, and this portability is greatly enhanced by the self contained engineering of the EcoSmart system. There is no need for a utility connection, which means you can transform the look and feel of your outdoor entertaining area when desired.

Or, leave your fireplace in a permanent position on the patio and design an enchanting outdoor space using the fireplace as the focal point. It has never been this easy to design a backyard or courtyard that feels so inviting.

**Optional Fire Screens**

Pair with a toughened glass fire screen, which stabilises the flame in windy conditions.

**Global Compliance**

This model complies with existing standards in the USA and Australia. UL Listed and ACCC Safety Mandate compliant.

**Decorative Media**

Concrete models come with black glass charcoal.

**Colours**

Available in three natural concrete colours.



**Environmentally-Friendly**

Bioethanol fireplaces use an environmentally-friendly, renewable energy source that burns clean and delivers warming heat. You and your guests will enjoy the ambiance and tranquility of a real fire, without the hassles of burning real wood - no more embers, ash, and soot to clean up.

**Quick and Easy**

With no installation or building works required, simply unpack, put into position, and off you go.

**Versatile and Incredibly Durable**

EcoSmart portable fireplaces are versatile, incredibly durable, and are constructed of heavy-gauge glass and weather resistant materials. These appliances are designed to look great for years, and will perform admirably through all four seasons.

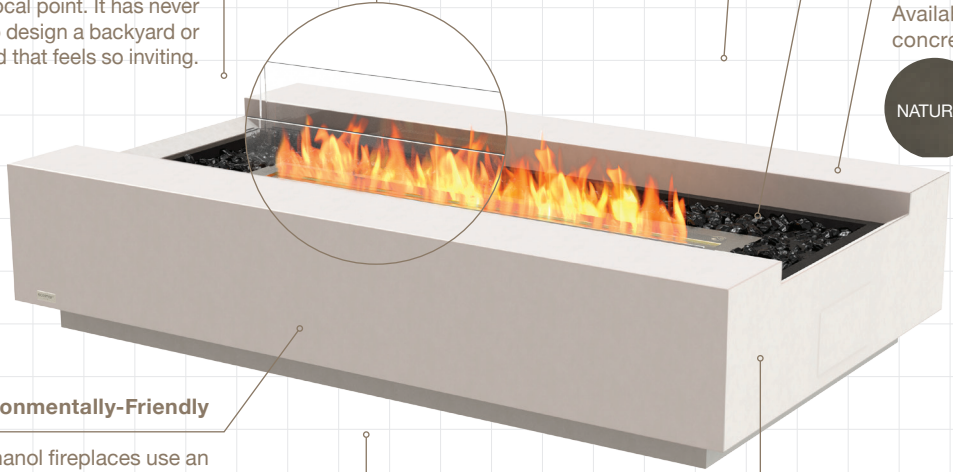

**OPTIONAL ACCESSORIES**

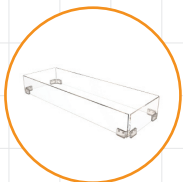

Fire Screen









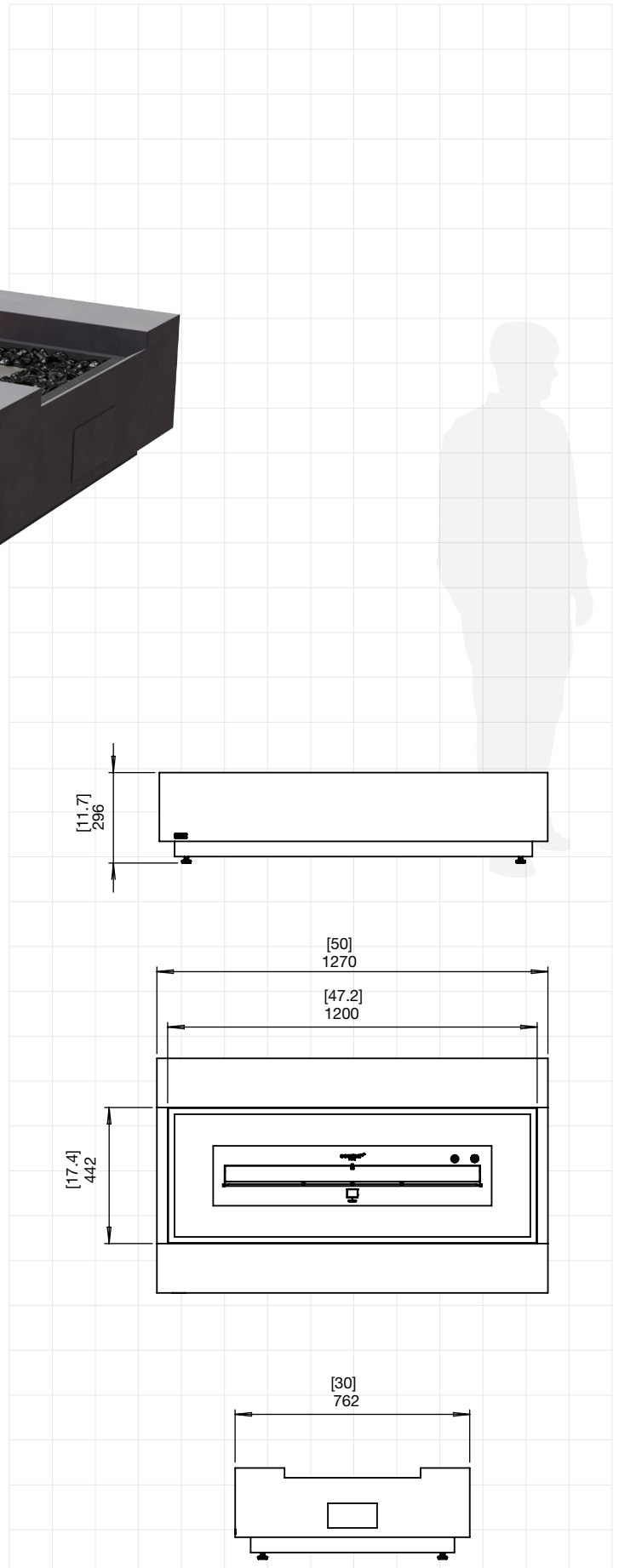

Protective Cover

Disclaimer. All product specifications and data are subject to change without notice and believed to be correct at the time of publication. MAD Design Group (MDG), its affiliates, agents, and employees, and all persons acting on its or their behalf (collectively, "MAD Design Group"), disclaim any and all liability for any errors, inaccuracies or incompleteness contained herein or in any other disclosure relating to any product. MDG disclaims any and all liability arising out of the use or application of any product described herein or of any information provided herein to the maximum extent permitted by law. The product specifications do not expand or otherwise modify MDG's terms and conditions of purchase, including but not limited to the warranty expressed therein, which apply to these products. No license, express or implied, by estoppel or otherwise, to any intellectual property rights is granted by this document or by any conduct of MDG. Customers using or selling MDG products not expressly indicated for use in such applications do so entirely at their own risk and agree to fully indemnify MDG for any damages arising or resulting from such use or sale. Please contact authorised personnel from MDG to obtain written terms and conditions regarding products designed for such applications. Images are indicative only.

# COSMO



<b>Application</b>	Outdoor									
<b>Materials</b>	Fluid Concrete Technology, Grade 304 Stainless Steel, Included Black Glass Charcoal									
<b>Weight</b>	98kg [215.6lbs] Weight includes burner and black glass charcoal.									
<b>Colours &amp; SKU's</b>	<table border="0"> <tr> <td></td> <td>Natural</td> <td>ESF.2.O.CMO.NA</td> </tr> <tr> <td></td> <td>Bone</td> <td>ESF.2.O.CMO.BO</td> </tr> <tr> <td></td> <td>Graphite</td> <td>ESF.2.O.CMO.GH</td> </tr> </table>		Natural	ESF.2.O.CMO.NA		Bone	ESF.2.O.CMO.BO		Graphite	ESF.2.O.CMO.GH
	Natural	ESF.2.O.CMO.NA								
	Bone	ESF.2.O.CMO.BO								
	Graphite	ESF.2.O.CMO.GH								
<b>Optional Accessories</b>	Fire Screen, Protective Cover									

## BURNER INFORMATION\*

<b>Burner</b>	XL900
<b>Fuel Type</b>	e-NRG Bioethanol
<b>Fuel Capacity</b>	9 Litres [2.4 Gallons]
<b>Heats on Average (when used indoors)</b>	Over 60 square metres [645 square feet]
<b>Burn Time</b>	8 - 13 hours (approx)
<b>Minimum Room Size</b>	110 cubic metres [3884 cubic feet] per fireplace.

\*These values are indicative only and may vary depending on the model purchased, installation, and the seasonal resource used to manufacture e-NRG.

This model comes with fixing brackets for permanently locating into a fixed position.

### Global Compliance

This model complies with existing standards in the USA and Australia. UL Listed and ACCC Safety Mandate compliant.

## FOR MORE INFORMATION PLEASE REFERENCE THE CLEARANCE & INSTALLATION MANUAL

Disclaimer. All product specifications and data are subject to change without notice and believed to be correct at the time of publication. MAD Design Group (MDG), its affiliates, agents, and employees, and all persons acting on its or their behalf (collectively, "MAD Design Group"), disclaim any and all liability for any errors, inaccuracies or incompleteness contained herein or in any other disclosure relating to any product. MDG disclaims any and all liability arising out of the use or application of any product described herein or of any information provided herein to the maximum extent permitted by law. The product specifications do not expand or otherwise modify MDG's terms and conditions of purchase, including but not limited to the warranty expressed therein, which apply to these products. No license, express or implied, by estoppel or otherwise, to any intellectual property rights is granted by this document or by any conduct of MDG. Customers using or selling MDG products not expressly indicated for use in such applications do so entirely at their own risk and agree to fully indemnify MDG for any damages arising or resulting from such use or sale. Please contact authorized personnel from MDG to obtain written terms and conditions regarding products designed for such applications. Images are indicative only.