

ASSEMBLY INSTRUCTIONS
END TABLE
IT-180661



CUSTOMER SERVICE INFORMATION

Please do not return to the store. If any pieces are missing call our toll free number at 1-888-287-4275 from 9:00 am to 5.00 pm CST (Monday to Friday) for replacement parts. For faster service, have the style number handy when calling.

GENERAL INFORMATION & TIPS



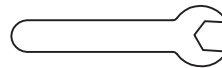

1. Please read the assembly instructions prior to assembling the rocking table.
2. To avoid damage, assemble the table on a non-abrasive surface such as carpet.
3. Make sure all nuts tightly fastened before the table is used.
4. This table is not for commercial use.

Please make sure you have all parts before beginning assembly. Please wait until all steps are completed before tightening bolts.

1. A Wrench is necessary for assembly it's included in hardware list.

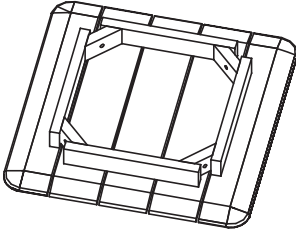
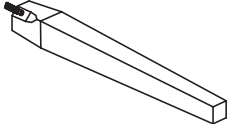

PARTS AND HARDWARE LIST

A. Table Top	B. Leg	C. Washer	D. Spring Washer
			
QTY: 1 pc	QTY: 4 pcs	QTY: 4 pcs + 1	QTY: 4 pcs + 1
E. Nut			
			
QTY: 4 pcs + 1			

STEP 1

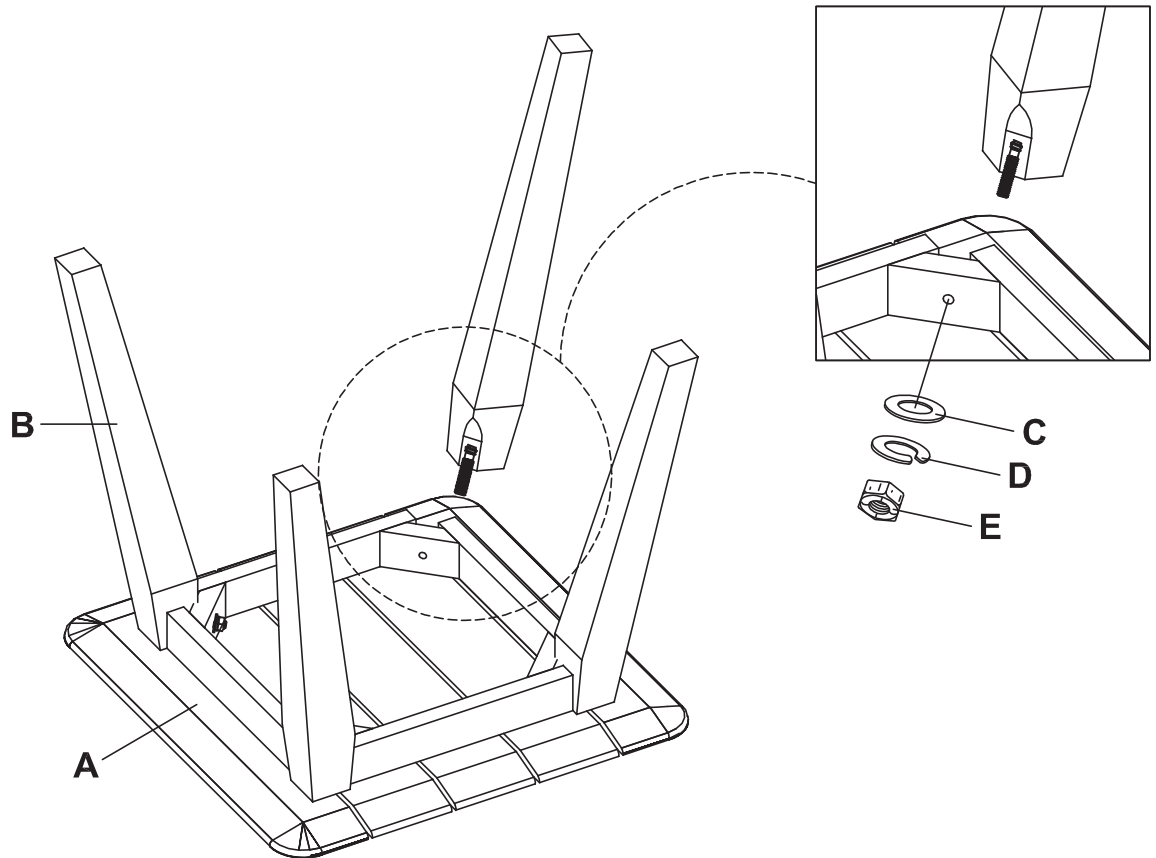

- Attach leg (B) into corner of table top (A).
Insert washer (C), spring washer (D) and nut (E) to secure leg (B).
Tighten nuts using wrench, provided.

STEP 2

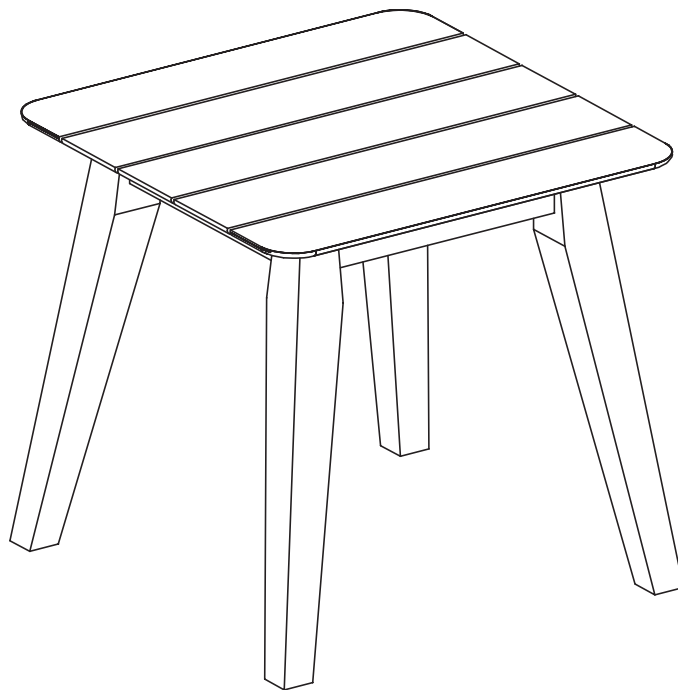

CONGRATULATION !

THE TABLE IS NOW READY FOR USE.